

Code•Master™ PLT Factory Sealed Luminaires

Explosionproof, Dust-Ignitionproof

Integrally Ballasted. 26 W, 32 W, 42 W, 52 W, 64 W, 84 W Compact Fluorescent. For use with Threaded Metal Conduit.

NEC:

Class I, Division 1 and 2, Groups B♦, C, D
Class II, Division 1 and 2, Groups E, F, G
Class III
NEMA 4X
Suitable for use in wet locations

CEC:

Class I, Division 1 and 2, Groups B, C, D
Class II, Division 1 and 2, Groups E, F, G
Class III
CSA 4X

Applications

- For use in hazardous locations such as plants where plastics, paints, thinners and petrochemicals are manufactured, and in other areas where ignitable vapors, dust, moisture and corrosive elements may be present.
- For use in areas where an instant-on white light is desired.
- Suitable for use in wet locations.
- Standard fixtures designed for 26 W, 32 W, 42 W, 52 W (two 26 W), 64 W (two 32 W), and 84 W (two 42 W) PLT lamps.
- Cold weather starting to a minimum temperature of -18 °C (0 °F) for the Code•Master Jr. PLT and -30 °C (-22 °F) for the Code•Master 2 PLT.

Features

- Fixtures operate safely in high ambient temperatures.
- Arrangement of heat-producing components results in efficient heat dissipation for cooler fixture operation.
- Patented “wireless” design. Threading of fixture unit onto mounting hood makes electrical connection. The only wiring required is attaching two wires to connection block in mounting hood.
- Connection block is easily wired: (a) loosen two screws; (b) make wire connections; and (c) reposition connection block.
- Safe, easy servicing without disconnecting any wiring. “Wireless” fixture unit threads off mounting hood for convenient servicing or for immediate replacement with a “stand-by” unit.
- Acme double-lead threads speed installation and fixture removal from mounting hood – only half as many turns are required as for single-lead threads. The threads do not stick, or gall, eliminating problems often encountered with single-lead threads during fixture unit removal.
- All threaded joints are flame-tight.
- Factory sealed. External seals not required for Groups C and D.
- Fixtures for use in Group B locations are furnished complete with UL required sealing fitting for Code•Master Jr. PLT only.
- Heat- and impact-resistant globes have smooth dust-resistant exterior.
- Superior corrosion resistance, with epoxy powder coat finish.
- Fluorescent light source reduces energy cost.
- Strategic location of lamp socket, in combination with interior prism design of the glass globe, provides optimum light distribution and control.
- Choice of mountings – pendant, ceiling, bracket and stanchion.
- Optional guards protect globes from damage. Secured to fixture with three stainless steel screws.
- Fiberglass reinforced polyester reflectors, in standard dome or 30° angle styles, are ideal in installations where luminaire is subject to exceptionally severe corrosive atmospheres. The high bay aluminum reflector is intended for installations where mounting height work planes range from 6 to 9 m (20 to 30 ft).
- Fluorescent lamp life of 10,000 hours reduces relamping cost compared to incandescent, and provides superior T numbers.

Standard Materials

- Ballast bodies and guards: copperfree (4/10 of 1% max.) aluminum
- Pendant mounting hoods: diecast copperfree (4/10 of 1% max.) aluminum
- Ceiling, bracket and stanchion mounting hoods: sand cast copperfree (4/10 of 1% max.) aluminum
- Reflectors: fiberglass reinforced polyester (white) or aluminum



26-42W Code•Master Jr. PLT



52-84W Code•Master 2 PLT

Illustrated Features



As Fixture unit is threaded into mounting hood an automatic electrical connection is made.

Standard Finishes

- Ballast bodies, guards and mounting hoods: epoxy powder coat finish, electrostatically applied for complete, uniform corrosion protection

NEC/CEC Certifications and Compliances

- UL Standard: UL 1598, UL 844
- UL Listed: E10444
- CSA Standard: C22.2 No. 250, C22.2 No. 137
- CSA Certified: 025428

♦ Fixtures are for use with Group B atmospheres only when used with Group B mounting hoods. For 26 W, 32 W, and 42 W fixtures only.

Code•Master™ PLT Factory Sealed Luminaires

Explosionproof, Dust-Ignitionproof

Integrally Ballasted. 26 W, 32 W, 42 W, 52 W, 64 W, 84 W Compact Fluorescent. For use with Threaded Metal Conduit.

NEC:

Class I, Division 1 and 2, Groups B♦, C, D
 Class II, Division 1 and 2, Groups E, F, G
 Class III
 NEMA 4X
 Suitable for use in wet locations

CEC:

Class I, Division 1 and 2, Groups B, C, D
 Class II, Division 1 and 2, Groups E, F, G
 Class III
 CSA 4X

Catalog Numbering Guide

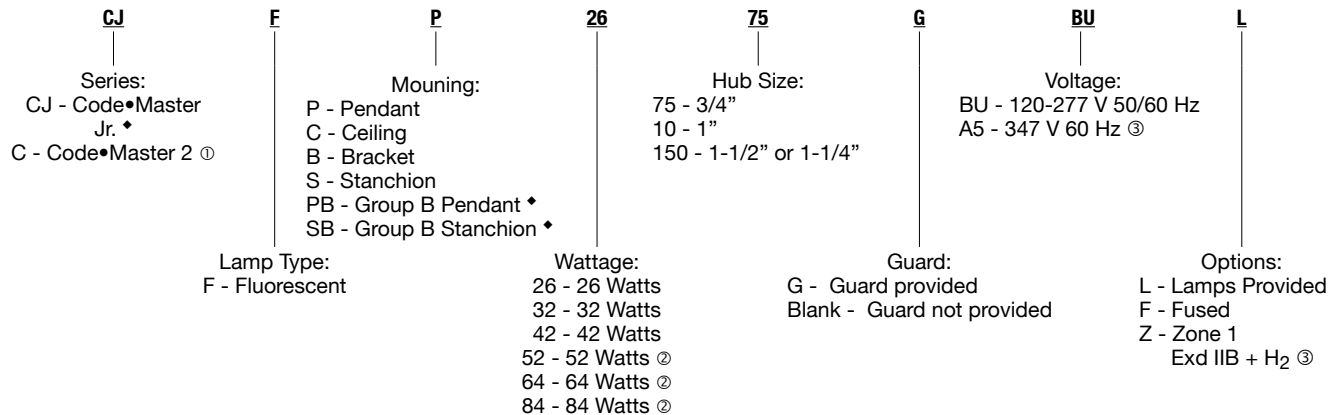

Classified Area Suitability of Code•Master™ Series PLT Fixtures — Suitability includes use of reflector

Lamp Type	Lamp Watts	Supply Wire °C (°F)	Ambient Temp °C (°F)	Class I, Division 1 and 2 with Globe or with Reflector UL/NEC Temp. Ident. No.		Class II, Division 1 and 2 with Globe or with Reflector UL/NEC Temp. Ident. No.	
				Nameplate Marking	Groups	Nameplate Marking	Groups
PLT (4-pin)	26	75 (167)	40 (104)	T6	B♦,C,D	T4A	E, F, G
PLT (4-pin)	32	75 (167)	40 (104)	T6	B♦,C,D	T4A	E, F, G
PLT (4-pin)	42	75 (167)	40 (104)	T6	B♦,C,D	T4A	E, F, G
PLT (4-pin)	52 (2 x 26)	75 (167)	40 (104)	T6	C, D	T4	E, F, G
		75 (167)	55 (131)	T5	C, D	—	—
PLT (4-pin)	64 (2 x 32)	75 (167)	40 (104)	T6	C, D	T4	E, F, G
		75 (167)	55 (131)	T5	C, D	—	—
PLT (4-pin)	84 (2 x 42)	75 (167)	40 (104)	T6	C, D	T4	E, F, G
		75 (167)	55 (131)	T5	C, D	—	—
		75 (167)	65 (149)	T5	C, D	—	—

“T” Numbers Represent the Maximum Surface Temperature for Class I, Division 1 Locations and Maximum Surface Temperature Under Dust Blanket for Class II, Division 1 Locations.

“T” Number	T1	350	325	T2	T2A	T2B	T2C	T2D	T3	T3A	T3B	T3C	T4	T4A	T5	T6
Temp. Range (°C)	351-450	326-350	301-325	281-300	261-280	231-260	216-230	201-215	181-200	166-180	161-165	136-160	121-135	101-120	86-100	85
Temp Range (°F)	664-842	619-662	574-617	538-572	502-536	448-500	421-446	394-419	358-392	331-356	322-329	277-320	250-275	214-248	187-212	185

♦ Fixtures are for use with Group B atmospheres only when used with Group B mounting hoods. For 26 W, 32 W, and 42 W fixtures only.

① Available only for 52, 64 and 84 watt fixtures.

② Available in Codemmaster 2 Only

③ Certified to meet the Canadian Electrical Code (CEC) only.



 Appleton
 FLUORESCENT/AREA: NEC/CEC EXPLOSIONPROOF

Code•Master™ PLT Factory Sealed Luminaires

Explosionproof, Dust-Ignitionproof

Integrally Ballasted. 26 W, 32 W, 42 W, 52 W, 64 W, 84 W Compact Fluorescent. For use with Threaded Metal Conduit.

NEC:
 Class I, Division 1 and 2, Groups B♦, C, D
 Class II, Division 1 and 2, Groups E, F, G
 Class III
 NEMA 4X
 Suitable for use in wet locations

	Lamp Watts	Hub Size (Inches)	Catalog Number with Globe ①
Pendant — One Hub, Rigid or Flexible Mounting			
	26	3/4	CJFPB2675BU
	32	3/4	CJFPB3275BU
	42	3/4	CJFPB4275BU

	26	1-1/2	CJFSB26150BU
	32	1-1/2	CJFSB32150BU
	42	1-1/2	CJFSB42150BU

Mounting Hoods

	Hub Size Inches	Catalog Number
Pendant — One Hub		
	3/4	CAP-75B

25° Stanchion — One Hub ②		
	1-1/2	CAS-150B

NOTE: Fixture units are the same as listed on following pages.

♦ Fixtures are for use with Group B atmospheres only when used with Group B mounting hoods. For 26 W, 32 W, and 42 W fixtures only.

① To order fixture with lamp(s), add suffix -L after voltage suffix.

② Malleable iron sealing fittings are available in the Fittings Section.

Code•Master™ PLT Factory Sealed Luminaires

Explosionproof, Dust-Ignitionproof





Integrally Ballasted. 26 W, 32 W, 42 W, 52 W, 64 W, 84 W Compact Fluorescent. For use with Threaded Metal Conduit.

NEC:

Class I, Division 1 and 2, Groups B♦, C, D
Class II, Division 1 and 2, Groups E, F, G
Class III
NEMA 4X
Suitable for use in wet locations

CEC:

Class I, Division 1 and 2, Groups B, C, D
Class II, Division 1 and 2, Groups E, F, G
Class III
CSA 4X

	Lamp Watts	Hub Size (Inches)	NEC Catalog Number with Globe ①③	CEC Catalog Number with Globe ①③
Pendant — One Hub, Rigid or Flexible Mounting				
	26 (1 x 26)	3/4	CJFP2675BU	CJFP2675A5
		1	CJFP2610BU	CJFP2610A5
	32 (1 x 32)	3/4	CJFP3275BU	CJFP3275A5
		1	CJFP3210BU	CJFP3210A5
	42 (1 x 42)	3/4	CJFP4275BU	CJFP4275A5
		1	CJFP4210BU	CJFP4210A5
	52 (2 x 26)	3/4	CFP5275BU	CFP5275A5
		1	CFP5210BU	CFP5210A5
	64 (2 x 32)	3/4	CFP6475BU	CFP6475A5
		1	CFP6410BU	CFP6410A5
84 (2 x 42)	3/4	CFP8475BU	CFP8475A5	
	1	CFP8410BU	CFP8410A5	
Ceiling — Four Hubs, Three Close-Up Plugs				
	26 (1 x 26)	3/4	CJFC2675BU	CJFC2675A5
		1	CJFC2610BU	CJFC2610A5
	32 (1 x 32)	3/4	CJFC3275BU	CJFC3275A5
		1	CJFC3210BU	CJFC3210A5
	42 (1 x 42)	3/4	CJFC4275BU	CJFC4275A5
		1	CJFC4210BU	CJFC4210A5
	52 (2 x 26)	3/4	CFC5275BU	CFC5275A5
		1	CFC5210BU	CFC5210A5
	64 (2 x 32)	3/4	CFC6475BU	CFC6475A5
		1	CFC6410BU	CFC6410A5
84 (2 x 42)	3/4	CFC8475BU	CFC8475A5	
	1	CFC8410BU	CFC8410A5	
Bracket — Four Hubs, Three Close-Up Plugs				
	26 (1 x 26)	3/4	CJFB2675BU	CJFB2675A5
		1	CJFB2610BU	CJFB2610A5
	32 (1 x 32)	3/4	CJFB3275BU	CJFB3275A5
		1	CJFB3210BU	CJFB3210A5
	42 (1 x 42)	3/4	CJFB4275BU	CJFB4275A5
		1	CJFB4210BU	CJFB4210A5
	52 (2 x 26)	3/4	CFB5275BU	CFB5275A5
		1	CFB5210BU	CFB5210A5
	64 (2 x 32)	3/4	CFB6475BU	CFB6475A5
		1	CFB6410BU	CFB6410A5
84 (2 x 42)	3/4	CFB8475BU	CFB8475A5	
	1	CFB8410BU	CFB8410A5	
25° Stanchion — One Hub				
	26 (1 x 26)	1-1/4 or 1-1/2 ②	CJFS26150BU	CJFS26150A5
	32 (1 x 32)	1-1/4 or 1-1/2 ②	CJFS32150BU	CJFS32150A5
	42 (1 x 42)	1-1/4 or 1-1/2 ②	CJFS42150BU	CJFS42150A5
	52 (2 x 26)	1-1/4 or 1-1/2 ②	CFS52150BU	CFS52150A5
	64 (2 x 32)	1-1/4 or 1-1/2 ②	CFS64150BU	CFS64150A5
	84 (2 x 42)	1-1/4 or 1-1/2 ②	CFS84150BU	CFS84150A5

♦ Fixtures are for use with Group B atmospheres only when used with Group B mounting hoods. For 26 W, 32 W, and 42 W fixtures only.

① To order fixture with guard, add suffix -G before adding voltage suffix. To order fixture with lamp(s), add suffix -L after voltage suffix.

② 1-1/2" tapped hub furnished with 1-1/2" to 1-1/4" reducer.

③ BU is 120 through 277 V, 50/60 Hz and 125 Vdc. A5 is 347 V, 60 Hz.

Shaded items are suitable for Class I, Group D ONLY.

Appleton

FLUORESCENT/AREA: NEC/CEC EXPLOSIONPROOF

Code•Master™ PLT Factory Sealed Luminaires





Explosionproof, Dust-Ignitionproof

Integrally Ballasted. 26 W, 32 W, 42 W, 52 W, 64 W, 84 W Compact Fluorescent. For use with Threaded Metal Conduit.

NEC:
Class I, Division 1 and 2, Groups B♦, C, D
Class II, Division 1 and 2, Groups E, F, G
Class III
NEMA 4X
Suitable for use in wet locations

CEC:
Class I, Division 1 and 2, Groups B, C, D
Class II, Division 1 and 2, Groups E, F, G
Class III
CSA 4X

Mounting Hoods

	Hub Size (Inches)	Catalog Number
Pendant 	3/4	CAP-75
	1	CAP-100
Ceiling 	3/4	CAC-75
	1	CAC-100
Bracket 	3/4	CALB-75
	1	CALB-100
25° Stanchion 	1-1/4 or 1-1/2 ①	CAS-150 ①
Mounting Adapter with Connection Block 		CMAD-1

Fixture Units

	Line Voltage	Hz	Catalog Number
Ballast body with globe  26-42 W 52-84 W	120-277	50/60	CJB26FBU ②
	120-277	50/60	CJB32FBU ②
	120-277	50/60	CJB42FBU ②
	120-277	50/60	CMBF52BU
	120-277	50/60	CMBF64BU
	120-277	50/60	CMBF84BU

Electrical Specification

Lamp Wattage	Line Voltage	Frequency (Hz)	Line Amps	Input Watts	Min. Starting Temp
26 (1 x 26)	120-277	50/60	0.25-0.11	28	-18 °C (0 °F)
32 (1 x 32)	120-277	50/60	0.27-0.12	36	-18 °C (0 °F)
42 (1 x 42)	120-277	50/60	0.35-0.16	48	-18 °C (0 °F)
52 (2 x 26)	120-277	50/60	0.49-0.20	55	-30 °C (-22 °F)
64 (2 x 32)	120-277	50/60	0.57-0.24	67	-30 °C (-22 °F)
84 (2 x 42)	120-277	50/60	0.73-0.31	87	-30 °C (-22 °F)

♦ Fixtures are for use with Group B atmospheres only when used with Group B mounting hoods. For 26 W, 32 W, and 42 W fixtures only.

① 1-1/2" tapped hub furnished with 1-1/2" to 1-1/4" reducer.

② Denotes items that are suitable for Class I, Group B in addition to Class I, Groups C and D; and Class II, Groups E, F and G.

Shaded items are suitable for Class I, Group C in addition to Class I, Group D; Class II, Groups E, F and G; and Class III.

Code•Master™ PLT Factory Sealed Luminaires

Explosionproof, Dust-Ignitionproof









Integrally Ballasted. 26 W, 32 W, 42 W, 52 W, 64 W, 84 W Compact Fluorescent. For use with Threaded Metal Conduit.

NEC:

Class I, Division 1 and 2, Groups B♦, C, D
 Class II, Division 1 and 2, Groups E, F, G
 Class III
 NEMA 4X
 Suitable for use in wet locations

CEC:

Class I, Division 1 and 2, Groups B, C, D
 Class II, Division 1 and 2, Groups E, F, G
 Class III
 CSA 4X

		Description	Catalog Number	
White Polyester Reflectors				
 Standard Dome	 30° Angle Dome	For Globe Fixtures		
		Standard Dome	26, 32, 42 W	KR2-ST
		30° Angle	26, 32, 42 W	KR2-AN
		Standard Dome	52, 64, 84 W	CMR-4ST
		30° Angle	52, 64, 84 W	CMR-4AN
		Deep Dome	52, 64, 84 W	CMR-4DD
Aluminum Reflectors				
		High Bay	52, 64, 84 W	CMR-4HB
Prismatic Glass Globe and Ring Assembly				
 CJGL-175	 CGL-400	26, 32, 42 W	CJGL-175	
		52, 64, 84 W	CGL-400	
Aluminum Guards				
 CJGU-15	 CGU-4	26, 32, 42 W	CJGU-15	
		52, 64, 84 W	CGU4	
Three-Way Exit Sign				
	Epoxy enameled steel — 6"-high red lettering Mounts to fixture units in place of guard.			
	26, 32, 42 W		CJEXRN	
	52, 64, 84 W		EXR400	
Single Sided Exit Sign				
	Epoxy enameled steel — 6"-high red lettering Mounts to fixture units in place of guard. <i>Contact your sales representative regarding hazardous location suitability.</i>			
	26, 32, 42 W		AEXR-15R	

♦ Fixtures are for use with Group B atmospheres only when used with Group B mounting hoods. For 26 W, 32 W, and 42 W fixtures only.

Code•Master™ PLT Factory Sealed Luminaires

Explosionproof, Dust-Ignitionproof



Integrally Ballasted. 26 W, 32 W, 42 W, 52 W, 64 W, 84 W Compact Fluorescent. For use with Threaded Metal Conduit.

NEC:
 Class I, Division 1 and 2, Groups B♦, C, D
 Class II, Division 1 and 2, Groups E, F, G
 Class III
 NEMA 4X
 Suitable for use in wet locations

CEC:
 Class I, Division 1 and 2, Groups B, C, D
 Class II, Division 1 and 2, Groups E, F, G
 Class III
 CSA 4X

Description	Catalog Number
-------------	----------------

Replacement Parts – 26 W, 32 W, 42 W, 52 W, 64 W and 84 W

		Socket (lampholder) G24Q-4	26 thru 84 W	PLT32RS
PLT32RS	CJSA42	Single Socket Bracket Assembly	26, 32, 42 W	CJSA42
		Double Socket Bracket Assembly	52, 64, 84 W	CSA84
CSA84				

Lamps

	1 lamp = 26 W; 2 lamps = 52 W	26 W	PLT26
	1 lamp = 32 W; 2 lamps = 64 W	32 W	PLT32
	1 lamp = 42 W; 2 lamps = 84 W	42 W	PLT42

Connection Block

	For all Code•Master fixtures	VPT-7
---	------------------------------	--------------

Fixture and Accessory Weights kg (lb)

Fixture Size	Fixture Weight	Reflector Weight	Guard Weight
26 W, 32 W, 42 W	6.6 (14.55)	1.4 (3.09)	0.5 (1.10)
52 W, 64 W, 84 W	15.9 (35.05)	1.4 (3.09)	1.1 (2.43)

Mounting Hood Weights kg (lb)

Pendant	Ceiling	Bracket	Stanchion
0.9 (1.98)	1.8 (3.97)	2.7 (5.95)	0.9 (1.98)

Reflector Dimensions

Catalog Number	Description	Dimensions in mm (in)				Standard and Deep Dome	30° Angle
		A	B	C	D		
Standard Dome							
KR2-ST	26, 32, 42 W	203.2 (8.00)	152.4 (6.00)	429.3 (16.90)	—		
CMR-4ST	52, 64, 84 W	284.5 (11.20)	149.9 (5.90)	475.0 (18.70)	—		
Deep Dome							
CMR-4DD	52, 64, 84 W	268.2 (10.56)	177.8 (7.00)	515.6 (20.30)	—		
30° Angle							
KR2-AN	26, 32, 42 W	203.2 (8.00)	69.9 (2.75)	378.5 (14.90)	258.3 (10.17)		
CMR-4AN	52, 64, 84 W	268.2 (10.56)	127 (5.00)	410.5 (16.16)	247.7 (9.75)		

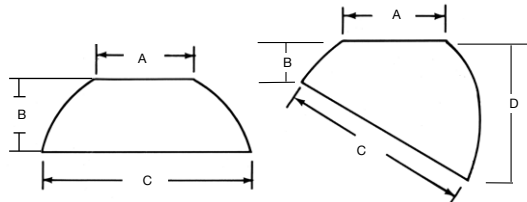

♦ Fixtures are for use with Group B atmospheres only when used with Group B mounting hoods. For 26 W, 32 W, and 42 W fixtures only.

Code•Master™ PLT Factory Sealed Luminaires

Explosionproof, Dust-Ignitionproof

Integrally Ballasted. 26 W, 32 W, 42 W, 52 W, 64 W, 84 W Compact Fluorescent. For use with Threaded Metal Conduit.

NEC:

Class I, Division 1 and 2, Groups B♦, C, D
 Class II, Division 1 and 2, Groups E, F, G
 Class III
 NEMA 4X
 Suitable for use in wet locations

CEC:

Class I, Division 1 and 2, Groups B, C, D
 Class II, Division 1 and 2, Groups E, F, G
 Class III
 CSA 4X

Dimensions in Millimeters (Inches)

Mounting Hoods

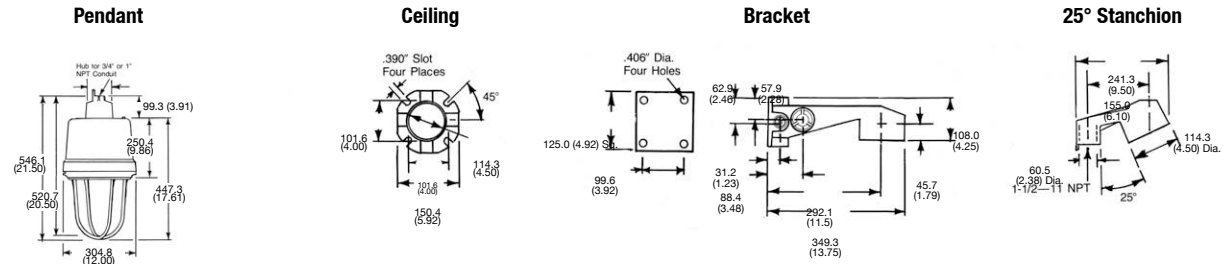

26, 32, 42 W Fixture

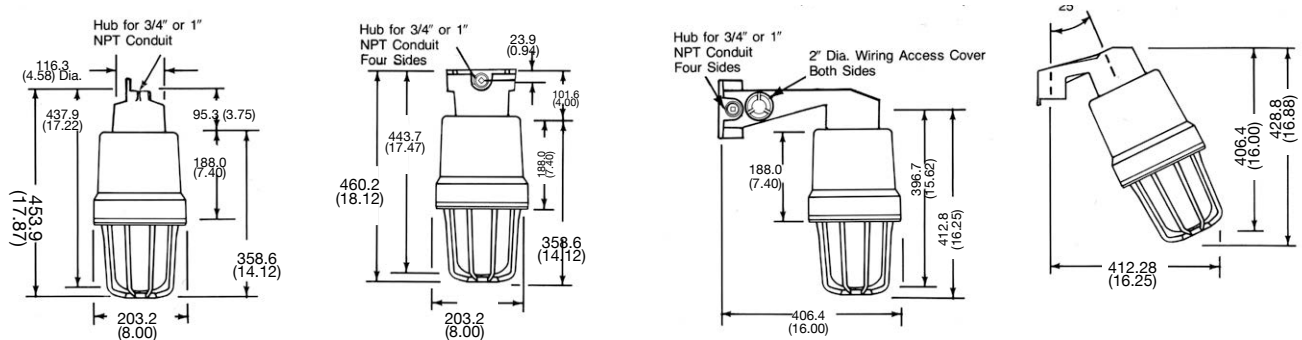

52, 64, 84 W Fixture

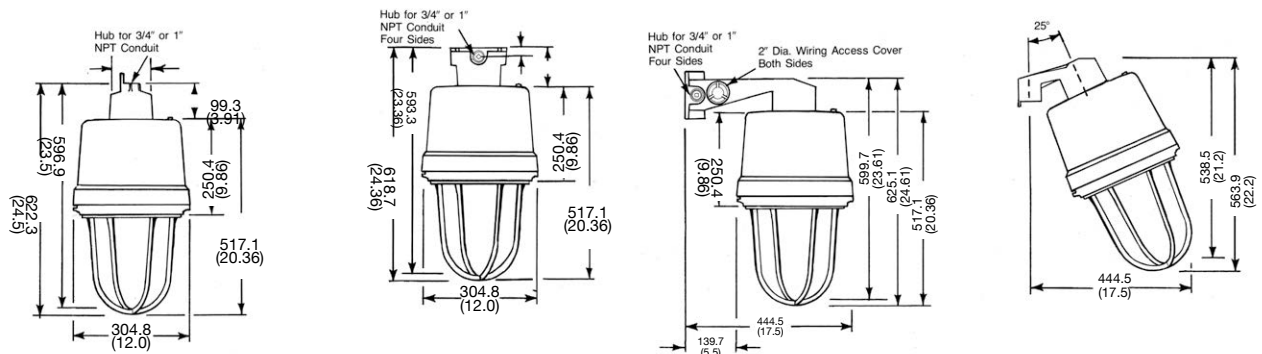

Exit Signs



♦ Fixtures are for use with Group B atmospheres only when used with Group B mounting hoods. For 26 W, 32 W, and 42 W fixtures only.

Code•Master™ PLT Factory Sealed Luminaires

Explosionproof, Dust-Ignitionproof

* Photometric data is based on a fixture with a 32 W compact fluorescent PL-T lamp (2,400 lumens). For candlepower values of fixtures with 26 W PL-T lamps (1,800 lumens), multiply by 0.75. For candlepower values of fixtures with a 42 W PL-T Lamp (3,200 lumens), multiply by 1.34.

NEC:
 Class I, Division 1 and 2, Groups B♦, C, D
 Class II, Division 1 and 2, Groups E, F, G
 Class III
 NEMA 4X
 Suitable for use in wet locations

CEC:
 Class I, Division 1 and 2, Groups B, C, D
 Class II, Division 1 and 2, Groups E, F, G
 Class III
 CSA 4X

Photometric Data

Total Luminaire Efficiency = 92.9%

CIE Type – Semi-Direct

Plane	Spacing Criteria
0-180	2.76
90-270	2.76
Diagonal	2.72

Zone	Lumens
0-10	9.75
10-20	32.89
20-30	68.63
30-40	119.65
40-50	174.44
50-60	219.68
60-70	252.32
70-80	278.38
80-90	283.11
90-100	266.38
100-110	231.16
110-120	166.66
120-130	91.63
130-140	31.38
140-150	2.95
150-160	0.19
160-170	0.00
170-180	0.00

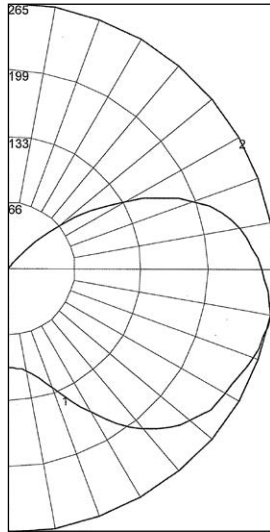

Maximum Candela = 265
 Located at Horizontal Angle = 0, Vertical Angle = 77.5
 #1 – Vertical Plane through Horizontal Angles (0–180) (Through Max. Cd.)
 #2 – Horizontal Cone through Vertical Angle (77.5) (Through Max. Cd.)

REPORT NUMBER: **CJBF32G**

32 W Fluorescent Lamp with Globe only *

Coefficients of Utilization – Zonal Cavity Method

Effective Floor Cavity Reflectance 0.20

% Ceiling	Rcc	80				70				50				30				10				0
		70	50	30	10	70	50	30	10	50	30	10	50	30	10	50	30	10	0			
% Walls	Rw	0	103	103	103	103	97	97	97	97	85	85	85	74	74	74	65	65	65	60		
		1	88	81	75	70	82	76	70	65	65	61	57	56	53	50	48	45	42	38		
		2	78	67	59	52	72	63	55	49	54	48	43	46	41	37	38	35	31	27		
		3	69	57	48	41	64	53	45	38	46	39	33	39	33	29	32	28	24	20		
		4	63	50	40	33	58	46	37	31	39	32	27	33	28	23	28	23	19	16		
		5	57	43	34	27	52	40	32	25	35	27	22	29	23	19	24	19	16	13		
		6	52	38	29	23	48	36	27	21	31	24	18	26	20	16	21	17	13	10		
		7	48	34	25	19	44	32	24	18	27	21	16	23	18	13	19	15	11	9		
		8	44	31	22	17	41	29	21	16	25	18	14	21	16	11	18	13	9	7		
		9	41	28	20	14	38	26	19	14	23	16	12	19	14	10	16	12	8	6		
		10	38	25	18	13	35	24	17	12	21	15	10	18	12	9	15	10	7	5		

Zonal Lumen Summary

Zone	Lumens	% Lamp	% Fixture	Zone	Lumens	% Lamp	% Fixture
0-30	111.27	4.6	5.0	90-120	664.20	27.7	29.8
0-40	230.92	9.6	10.4	90-130	755.83	31.5	33.9
0-60	625.05	26.0	28.0	90-150	790.17	32.9	33.9
0-90	1438.87	60.0	64.5	90-180	790.36	32.9	35.5
				0-180	2229.23	92.9	100.0

Total Luminaire Efficiency = 80.7%

CIE Type – Direct

Plane	Spacing Criteria
0-180	1.42
90-270	1.42
Diagonal	1.60

Zone	Lumens
0-10	51.88
10-20	151.03
20-30	240.04
30-40	312.02
40-50	361.09
50-60	377.88
60-70	278.20
70-80	119.22
80-90	23.81
90-100	0.68
100-110	4.48
110-120	6.82
120-130	5.50
130-140	3.07
140-150	0.09
150-160	0.00
160-170	0.00
170-180	0.00

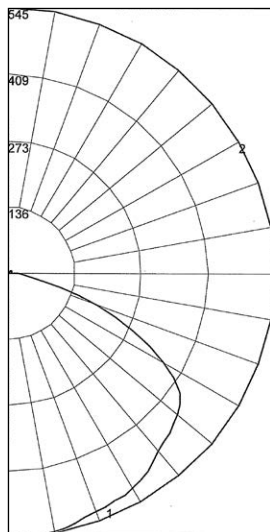

Maximum Candela = 545
 Located at Horizontal Angle = 0, Vertical Angle = 5
 #1 – Vertical Plane through Horizontal Angles (0–180) (Through Max. Cd.)
 #2 – Horizontal Cone through Vertical Angle (5) (Through Max. Cd.)

REPORT NUMBER: **CJBF32ST**

32 W Fluorescent Lamp with Globe and Standard Dome Reflector *

Coefficients of Utilization – Zonal Cavity Method

Effective Floor Cavity Reflectance 0.20

% Ceiling	Rcc	80				70				50				30				10				0
		70	50	30	10	70	50	30	10	50	30	10	50	30	10	50	30	10	0			
% Walls	Rw	0	96	96	96	96	93	93	93	93	89	89	89	85	85	85	82	82	82	80		
		1	87	84	80	77	85	82	78	76	78	75	73	75	73	71	72	70	68	67		
		2	79	72	67	62	77	71	66	61	68	63	60	65	61	58	62	59	57	55		
		3	72	63	56	51	70	62	55	50	59	54	49	57	52	48	54	51	47	45		
		4	65	55	48	42	63	54	47	42	52	46	41	50	45	41	48	44	40	38		
		5	60	49	41	36	58	48	41	36	46	40	35	44	39	35	43	38	34	32		
		6	55	44	36	31	53	43	36	31	41	35	30	40	34	30	39	34	30	28		
		7	51	39	32	27	49	39	32	27	37	31	27	36	30	26	35	30	26	24		
		8	47	36	29	24	46	35	28	24	34	28	23	33	27	23	32	27	23	21		
		9	44	33	26	21	43	32	26	21	31	25	21	30	25	21	29	24	21	19		
		10	41	30	23	19	40	30	23	19	29	23	19	28	23	19	27	22	19	17		

Zonal Lumen Summary

Zone	Lumens	% Lamp	% Fixture	Zone	Lumens	% Lamp	% Fixture
0-30	442.95	18.5	22.9	90-120	11.98	0.5	0.6
0-40	754.97	31.5	39.0	90-130	17.48	0.7	0.9
0-60	1493.95	62.2	77.2	90-150	20.63	0.9	0.9
0-90	1915.18	79.8	98.9	90-180	20.63	0.9	1.1
				0-180	1935.81	80.7	100.0

◆ Fixtures are for use with Group B atmospheres only when used with Group B mounting hoods. For 26 W, 32 W, and 42 W fixtures only.

Code•Master™ PLT Factory Sealed Luminaires

Explosionproof, Dust-Ignitionproof

* Photometric data is based on a fixture with a 32 W compact fluorescent PL-T lamp (2,400 lumens). For candlepower values of fixtures with 26 W PL-T lamps (1,800 lumens), multiply by 0.75. For candlepower values of fixtures with a 42 W PL-T Lamp (3,200 lumens), multiply by 1.34. ** Photometric data is based on a fixture with two 32 W Compact Fluorescent PL-T lamps (2,400 lumens each). For candlepower values of fixtures with two 26 W PL-T lamps (1,800 lumens each), multiply by 0.75. For Candlepower values of fixtures with two 42 W PL-T Lamps. (3,200 lumens each) multiply by 1.34.

NEC:

Class I, Division 1 and 2, Groups B, C, D
Class II, Division 1 and 2, Groups E, F, G
Class III
NEMA 4X
Suitable for use in wet locations

CEC:

Class I, Division 1 and 2, Groups B, C, D
Class II, Division 1 and 2, Groups E, F, G
Class III
GSA 4X

Photometric Data

Total Luminaire Efficiency = 76.6%

CIE Type – Direct

Plane	Spacing Criteria
0-180	1.48
90-270	1.62
Diagonal	1.54

Zone	Lumens
0-10	42.08
10-20	124.46
20-30	205.20
30-40	273.31
40-50	299.53
50-60	283.93
60-70	240.60
70-80	181.91
80-90	110.47
90-100	50.28
100-110	18.05
110-120	5.01
120-130	1.80
130-140	1.13
140-150	0.05
150-160	0.00
160-170	0.00
170-180	0.00

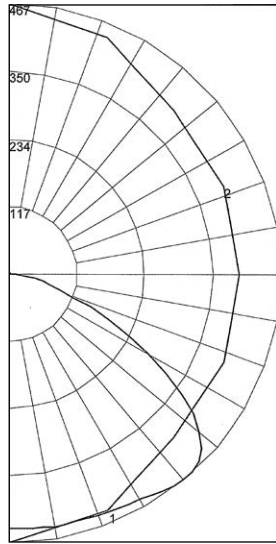

Maximum Candela = 467
 Located at Horizontal Angle = 90, Vertical Angle = 40
 #1 – Vertical Plane through Horizontal Angles (90–270) (Through Max. Cd.)
 #2 – Horizontal Cone through Vertical Angle (40) (Through Max. Cd.)

REPORT NUMBER: **CJBF32AN**

32 W Fluorescent Lamp with Globe and 30° Angle Dome Reflector *

Coefficients of Utilization – Zonal Cavity Method

Effective Floor Cavity Reflectance 0.20

% Ceiling % Walls	Rcc Rw	80				70				50				30				10				0
		70	50	30	10	70	50	30	10	50	30	10	50	30	10	50	30	10				
0	0	90	90	90	90	88	88	88	88	83	83	83	79	79	79	75	75	75	73			
1	1	81	76	72	69	78	74	71	67	70	67	64	67	64	62	63	61	59	58			
2	2	73	65	59	54	70	64	58	53	60	56	52	57	53	50	54	51	48	46			
3	3	66	57	50	44	63	55	49	44	52	47	42	50	45	41	47	43	40	38			
4	4	60	50	42	37	58	48	42	36	46	40	35	44	39	35	42	37	34	32			
5	5	55	44	37	31	53	43	36	31	41	35	30	39	34	30	37	33	29	27			
6	6	50	39	32	27	49	39	32	27	37	31	26	35	30	26	34	29	25	23			
7	7	47	36	28	23	45	35	28	23	33	27	23	32	26	22	31	26	22	20			
8	8	43	32	25	21	42	32	25	21	30	24	20	29	24	20	28	23	20	18			
9	9	40	30	23	18	39	29	23	18	28	22	18	27	22	18	26	21	18	16			
10	10	38	27	21	17	36	27	21	17	26	20	16	25	20	16	24	19	16	14			

Zonal Lumen Summary

Zone	Lumens	% Lamp	% Fixture	Zone	Lumens	% Lamp	% Fixture
0-30	371.75	15.5	20.2	90-120	73.34	3.1	4.0
0-40	645.06	26.9	35.1	90-130	75.13	3.1	4.1
0-60	1228.52	51.2	66.8	90-150	76.32	3.2	4.1
0-90	1761.50	73.4	95.8	90-180	76.32	3.2	4.2
0-180	1837.81	76.6	100.0				

Total Luminaire Efficiency = 79.8%

CIE Type – Semi-Direct

Plane	Spacing Criteria
0-180	2.88
90-270	2.88
Diagonal	2.82

Zone	Lumens
0-10	17.70
10-20	61.05
20-30	132.44
30-40	236.78
40-50	336.66
50-60	421.68
60-70	485.34
70-80	517.29
80-90	513.72
90-100	468.70
100-110	352.77
110-120	200.85
120-130	73.54
130-140	11.28
140-150	1.12
150-160	0.31
160-170	0.06
170-180	0.00

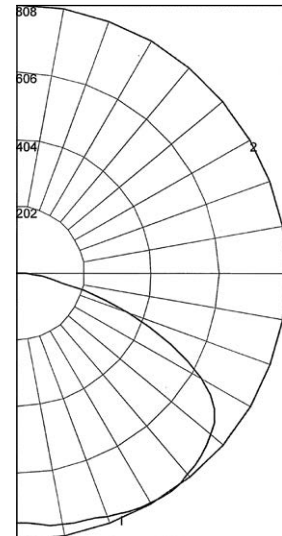

Maximum Candela = 493
 Located at Horizontal Angle = 0, Vertical Angle = 70
 #1 – Vertical Plane through Horizontal Angles (0–180) (Through Max. Cd.)
 #2 – Horizontal Cone through Vertical Angle (70) (Through Max. Cd.)

REPORT NUMBER: **CMBF64G**

64 W (two 32 W lamps) Fluorescent Fixture with Globe only **

Coefficients of Utilization – Zonal Cavity Method

Effective Floor Cavity Reflectance 0.20

% Ceiling % Walls	Rcc Rw	80				70				50				30				10				0
		70	50	30	10	70	50	30	10	50	30	10	50	30	10	50	30	10				
0	0	90	90	90	90	85	85	85	85	76	76	76	68	68	68	60	60	60	57			
1	1	76	70	65	60	71	66	61	57	58	54	51	51	48	45	45	42	40	36			
2	2	67	58	51	45	63	55	48	42	48	43	38	42	37	34	36	32	29	26			
3	3	60	49	41	35	56	46	39	33	40	34	29	35	30	26	30	26	23	20			
4	4	54	43	34	28	50	40	32	26	35	28	23	30	25	21	26	21	18	15			
5	5	49	37	29	23	46	35	27	22	31	24	19	26	21	17	23	18	15	12			
6	6	45	33	25	19	42	31	23	18	27	21	16	23	18	14	20	16	12	10			
7	7	41	29	22	16	38	28	20	15	24	18	14	21	16	12	18	14	10	8			
8	8	38	26	19	14	36	25	18	13	22	16	12	19	14	10	16	12	9	7			
9	9	35	24	17	12	33	23	16	11	20	14	10	17	12	9	15	11	8	9			
10	10	33	22	15	11	31	21	14	10	18	13	9	16	11	8	14	10	7	5			

Zonal Lumen Summary

Zone	Lumens	% Lamp	% Fixture	Zone	Lumens	% Lamp	% Fixture
0-30	211.19	4.4	5.5	90-120	1022.32	21.3	26.7
0-40	447.97	9.3	11.7	90-130	1095.85	22.8	28.6
0-60	1206.31	25.1	31.5	90-150	1108.26	23.1	28.6
0-90	2722.64	56.7	71.1	90-180	1108.63	23.1	28.9
0-180	3831.28	79.8	100.0				

◆ Fixtures are for use with Group B atmospheres only when used with Group B mounting hoods. For 26 W, 32 W, and 42 W fixtures only.

Code•Master™ PLT Factory Sealed Luminaires

Explosionproof, Dust-Ignitionproof

** Photometric data is based on a fixture with two 32 W Compact Fluorescent PL-T lamps (2,400 lumens each). For candlepower values of fixtures with two 26 W PL-T lamps (1,800 lumens each), multiply by 0.75. For Candlepower values of fixtures with two 42 W PL-T lamps. (3,200 lumens each) multiply by 1.34.

NEC:
 Class I, Division 1 and 2, Groups B♦, C, D
 Class II, Division 1 and 2, Groups E, F, G
 Class III
 NEMA 4X
 Suitable for use in wet locations

CEC:
 Class I, Division 1 and 2, Groups B, C, D
 Class II, Division 1 and 2, Groups E, F, G
 Class III
 CSA 4X

Photometric Data

Total Luminaire Efficiency = 66.5%

CIE Type – Direct

Plane	Spacing Criteria
0-180	1.62
90-270	1.62
Diagonal	1.74

Zone Lumens

0-10	73.25
10-20	220.57
20-30	368.60
30-40	505.61
40-50	603.19
50-60	638.42
60-70	497.24
70-80	226.17
80-90	57.98
90-100	1.64
100-110	0.00
110-120	0.00
120-130	0.00
130-140	0.00
140-150	0.00
150-160	0.00
160-170	0.00
170-180	0.00

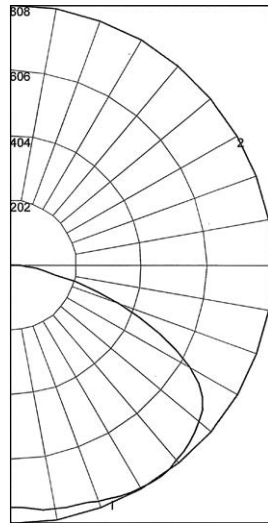

Maximum Candela = 808
 Located at Horizontal Angle = 0, Vertical Angle = 35
 #1 – Vertical Plane through Horizontal Angles (0–180)
 (Through Max. Cd.)
 #2 – Horizontal Cone through Vertical Angle (35)
 (Through Max. Cd.)

REPORT NUMBER: CMBF64ST

64 W (two 32 W lamps) Fluorescent Fixture with Globe and Standard Dome Reflector **

Coefficients of Utilization – Zonal Cavity Method

Effective Floor Cavity Reflectance 0.20

% Ceiling	Rcc	80				70				50				30				10				0													
		70	50	30	10	70	50	30	10	50	30	10	50	30	10	50	30	10																	
% Walls	Rw	0	1	2	3	4	5	6	7	8	9	10	0	1	2	3	4	5	6	7	8	9	10	0	1	2	3	4	5	6	7	8	9	10	
		79	79	66	63	77	77	64	62	74	74	60	62	60	58	59	58	56	55	48	46	45	44	41	38	37	30	26	23	22	22	19	17	15	13

Zonal Lumen Summary

Zone	Lumens	% Lamp	% Fixture	Zone	Lumens	% Lamp	% Fixture
0-30	662.42	13.8	20.7	90-120	1.64	0.0	0.1
0-40	1168.03	24.3	36.6	90-130	1.64	0.0	0.1
0-60	2409.64	50.2	75.5	90-150	1.64	0.0	0.1
0-90	3191.04	66.5	99.9	90-180	1.64	0.0	0.1
0-180	3192.68	66.5	100.0				

Total Luminaire Efficiency = 57.4%

CIE Type – Direct

Plane	Spacing Criteria
0-180	1.52
90-270	1.70
Diagonal	1.62

Zone Lumens

0-10	62.13
10-20	187.93
20-30	317.49
30-40	428.14
40-50	471.22
50-60	454.23
60-70	384.77
70-80	276.31
80-90	157.68
90-100	13.45
100-110	0.00
110-120	0.00
120-130	0.00
130-140	0.00
140-150	0.00
150-160	0.00
160-170	0.00
170-180	0.00

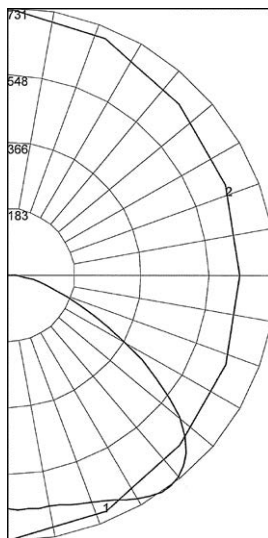

Maximum Candela = 731
 Located at Horizontal Angle = 90, Vertical Angle = 37.5
 #1 – Vertical Plane through Horizontal Angles (90–270)
 (Through Max. Cd.)
 #2 – Horizontal Cone through Vertical Angle (37.5)
 (Through Max. Cd.)

REPORT NUMBER: CMBF64AN

64 W (two 32 W lamps) Fluorescent Fixture with Globe and 30° Angle Dome Reflector **

Coefficients of Utilization – Zonal Cavity Method

Effective Floor Cavity Reflectance 0.20

% Ceiling	Rcc	80				70				50				30				10				0												
		70	50	30	10	70	50	30	10	50	30	10	50	30	10	50	30	10																
% Walls	Rw	0	1	2	3	4	5	6	7	8	9	10	0	1	2	3	4	5	6	7	8	9	10	0	1	2	3	4	5	6	7	8	9	10
		68	68	55	52	67	67	54	51	64	64	49	48	48	48	48	48	46	45	41	39	36	37	34	31	30	25	22	21	21	18	16	14	12

Zonal Lumen Summary

Zone	Lumens	% Lamp	% Fixture	Zone	Lumens	% Lamp	% Fixture
0-30	567.55	11.8	20.6	90-120	13.45	0.3	0.5
0-40	995.69	20.7	36.2	90-130	13.45	0.3	0.5
0-60	1921.14	40.0	69.8	90-150	13.45	0.3	0.5
0-90	2739.90	57.1	99.5	90-180	13.45	0.3	0.5
0-180	2753.35	57.4	100.0				

◆ Fixtures are for use with Group B atmospheres only when used with Group B mounting hoods. For 26 W, 32 W, and 42 W fixtures only.

Code•Master™ PLT Factory Sealed Luminaires

Explosionproof, Dust-Ignitionproof

** Photometric data is based on a fixture with two 32 W Compact Fluorescent PL-T lamps (2,400 lumens each). For candlepower values of fixtures with two 26 W PL-T lamps (1,800 lumens each), multiply by 0.75. For Candlepower values of fixtures with two 42 W PL-T Lamps, (3,200 lumens each) multiply by 1.34.

NEC:

Class I, Division 1 and 2, Groups B ♦, C, D
 Class II, Division 1 and 2, Groups E, F, G
 Class III
 NEMA 4X
 Suitable for use in wet locations

CEC:

Class I, Division 1 and 2, Groups B, C, D
 Class II, Division 1 and 2, Groups E, F, G
 Class III
 CSA 4X

Photometric Data

Total Luminaire Efficiency = 67.2%

CIE Type – Direct

Plane	Spacing Criteria
0-180	1.44
90-270	1.44
Diagonal	1.60

Zone	Lumens
0-10	88.95
10-20	260.61
20-30	413.34
30-40	539.82
40-50	630.36
50-60	641.74
60-70	436.60
70-80	164.84
80-90	47.37
90-100	1.92
100-110	0.00
110-120	0.00
120-130	0.00
130-140	0.00
140-150	0.00
150-160	0.00
160-170	0.00
170-180	0.00

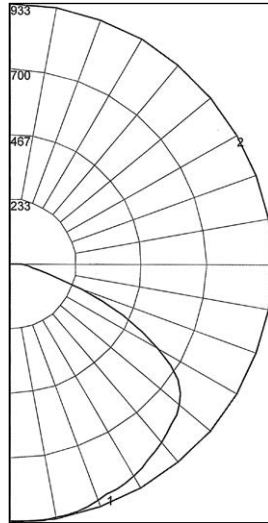

Maximum Candela = 933
 Located at Horizontal Angle = 0, Vertical Angle = 7.5
 #1 – Vertical Plane through Horizontal Angles (0–180) (Through Max. Cd.)
 #2 – Horizontal Cone through Vertical Angle (7.5) (Through Max. Cd.)

REPORT NUMBER: **CMBF64DD**

64 W (two 32 W lamps) Fluorescent Fixture with Globe and Deep Dome Reflector **

Coefficients of Utilization – Zonal Cavity Method

		Effective Floor Cavity Reflectance 0.20																				
% Ceiling	Rcc	80				70				50				30				10				0
% Walls	Rw	70	50	30	10	70	50	30	10	50	30	10	50	30	10	50	30	10	50	30	10	0
0	80	80	80	80	80	78	78	78	78	75	75	75	71	71	71	69	69	69	67			
1	73	70	67	65	65	71	68	66	63	66	63	61	63	61	60	60	59	58	56			
2	66	61	56	52	52	65	59	55	52	57	53	50	55	52	49	53	50	48	47			
3	60	53	47	43	43	59	52	47	43	50	45	42	48	44	41	46	43	40	39			
4	55	47	41	36	36	53	46	40	36	44	39	35	42	38	35	41	37	34	33			
5	50	41	35	31	31	49	41	35	30	39	34	30	38	33	30	37	33	29	28			
6	46	37	31	26	26	45	36	30	26	35	30	26	34	29	26	33	29	25	24			
7	43	33	27	23	23	41	33	27	23	32	27	23	31	26	23	30	26	22	21			
8	40	30	24	20	20	38	30	24	20	29	24	20	28	23	20	27	23	20	19			
9	37	28	22	18	18	36	27	22	18	26	21	18	26	21	18	25	21	18	16			
10	34	25	20	16	16	34	25	20	16	24	19	16	24	19	16	23	19	16	15			

Zonal Lumen Summary

Zone	Lumens	% Lamp	% Fixture	Zone	Lumens	% Lamp	% Fixture
0-30	762.91	15.9	23.7	90-120	1.92	0.0	0.1
0-40	1302.73	27.1	40.4	90-130	1.92	0.0	0.1
0-60	2574.82	53.6	79.8	90-150	1.92	0.0	0.1
0-90	3223.63	67.2	99.9	90-180	1.92	0.0	0.1
				0-180	3225.55	57.4	100.0

Total Luminaire Efficiency = 58.9%

CIE Type – Direct

Plane	Spacing Criteria
0-180	0.82
90-270	0.82
Diagonal	0.92

Zone	Lumens
0-10	239.15
10-20	599.67
20-30	645.20
30-40	625.54
40-50	452.95
50-60	185.71
60-70	58.40
70-80	15.26
80-90	4.25
90-100	0.69
100-110	0.00
110-120	0.00
120-130	0.00
130-140	0.00
140-150	0.00
150-160	0.00
160-170	0.00
170-180	0.00

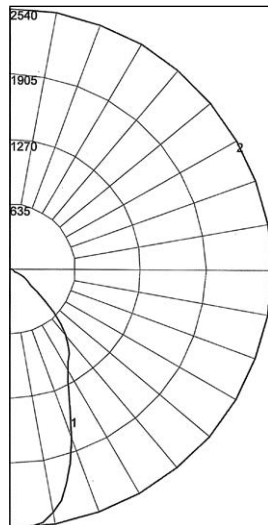

Maximum Candela = 2540
 Located at Horizontal Angle = 0, Vertical Angle = 5
 #1 – Vertical Plane through Horizontal Angles (0–180) (Through Max. Cd.)
 #2 – Horizontal Cone through Vertical Angle (5) (Through Max. Cd.)

REPORT NUMBER: **CMBF64HB**

64 W (two 32 W lamps) Fluorescent Fixture with Globe and High Bay Reflector **

Coefficients of Utilization – Zonal Cavity Method

		Effective Floor Cavity Reflectance 0.20																				
% Ceiling	Rcc	80				70				50				30				10				0
% Walls	Rw	70	50	30	10	70	50	30	10	50	30	10	50	30	10	50	30	10	50	30	10	0
0	70	70	70	70	70	68	68	68	68	65	65	65	63	63	63	60	60	60	59			
1	66	64	63	61	61	65	63	62	60	61	59	58	58	57	57	56	56	55	54			
2	62	59	56	54	54	61	58	55	53	56	54	52	54	52	51	52	51	50	49			
3	58	54	51	48	48	57	53	50	47	51	49	47	50	48	46	49	47	45	44			
4	55	50	46	43	43	54	49	45	43	48	44	42	46	44	42	45	43	41	40			
5	51	46	42	39	39	50	45	41	39	44	41	38	43	40	38	42	39	37	36			
6	48	42	38	35	35	47	42	38	35	41	37	35	40	37	35	39	36	34	33			
7	46	39	35	32	32	45	39	35	32	38	35	32	37	34	32	37	34	32	31			
8	43	37	33	30	30	42	36	32	30	36	32	30	35	32	29	34	31	29	28			
9	41	34	30	28	28	40	34	30	28	33	30	27	33	30	27	32	29	27	26			
10	38	32	28	26	26	38	32	28	26	31	28	26	31	28	25	30	27	25	25			

Zonal Lumen Summary

Zone	Lumens	% Lamp	% Fixture	Zone	Lumens	% Lamp	% Fixture
0-30	1484.03	30.9	52.5	90-120	0.69	0.0	0.0
0-40	2109.57	43.9	74.6	90-130	0.69	0.0	0.0
0-60	2748.23	57.3	97.2	90-150	0.69	0.0	0.0
0-90	2826.12	58.9	100.0	90-180	0.69	0.0	0.0
				0-180	2628.80	58.9	100.0

♦ Fixtures are for use with Group B atmospheres only when used with Group B mounting hoods. For 26 W, 32 W, and 42 W fixtures only.