



Table of Contents



HBL® Watertight IEC Pin and Sleeve



Advantage™ Series Switch-Rated Devices



Circuit-Lock® Unfused and Fused Mechanical Interlocks



Product	Page
Products at a Glance	G-2
Configurations Chart	G-3
IEC Pin and Sleeve	
Watertight Devices	G-6
Advantage™ Series Switch-Rated Devices	G-10
Corrosion Resistant Devices	G-12
Data Center Pin and Sleeve	G-13
Back Boxes	G-14
Accessories	G-15
Dimensions	G-16
Horsepower Ratings	G-19
Unfused Circuit-Lock® Mechanical Interlocks	
Devices and “Reverse Service”	G-21
Accessories and Dimensions	G-22
Fused Circuit-Lock® Mechanical Interlocks	
Devices and Accessories	G-25
Dimensions	G-26

Product	Page
Low Profile Pin and Sleeve	
Devices and Specifications	G-28
Dimensions	G-29
IEC Pin and Sleeve Terminal Identification	G-30
UL 1686 C1 InsulgrIP® Pin and Sleeve	
Style I and Style II Devices	G-34
“Reverse Service” Style I and II Devices	G-35
Back Boxes and Accessories	G-36
Dimensions	G-37
InsulgrIP® Mechanical Interlocks	
Style II, Fused and Unfused Devices	G-41
Dimensions	G-42
Hazardous Location Devices	
Mechanical Interlocks and Plugs	G-44
Dimensions	G-44



Products at a Glance



IEC Watertight Devices

- Provide safe and dependable performance in the most demanding environments
- Heavy duty non-conductive nylon construction provides impact and corrosion protection
- Thermoset polyester contact carriers withstand high temperatures and provide resistance to electrical tracking



Advantage™ Series Pin and Sleeve Switch-Rated Devices

- Advantage™ series devices are approved as disconnecting means for both motor circuitry and branch circuits
- Robust and durable housing, UV-stabilized, impact and corrosion-resistant PBT housing is designed to withstand harsh industrial environments



Corrosion Resistant Devices

- This superior grade of IEC and Insulgrip devices are ideal for the most demanding environments
- Nickel-plated brass on the IEC and nickel-plated Tellurium copper on the Insulgrip contacts prevent corrosion and heat rise



Back Boxes and Accessories

- A complete line of metallic and non-metallic back boxes, angle adapters, closure caps and liquidtight adapters are available
- Accessories aid with installation efficiencies and support the various applications in which the products are used



Insulgrip® NEMA 4X UL 1686 C1 Devices

- Metallic where you want it and non-metallic where you need it
- This tough product line is NEMA 4X rated for use in the harshest environments
- Devices are fully interchangeable with other manufacturers of UL1686 C1 devices



Circuit-Lock® Mechanical Interlocks

- IEC pin and sleeve devices are color coded by voltage for easy identification
- Available in either fused or non-fused versions
- IEC reverse service units available for safely connecting generators
- Lockable handle to meet OSHA Lockout/Tagout regulations



Low Profile Devices

- 90° Angled plugs and recessed receptacles allow for connections in tight spaces
- Cords can be controlled easily along the wall
- The integrated cord grips limit strain on terminals and prevent strain on plugs and cables exiting perpendicular from the wall



Hazardous Location Devices

- Copper-free aluminum construction with electrostatically applied polyester/epoxy finish to prevent corrosion
- Large visible rotary handle with ON/OFF indicator allows a quick means of disconnecting power



IEC Configurations Chart

Singly Rated Configurations

Hubbell Pin and Sleeve products are designed and manufactured to meet the International Standard IEC 60309-1 and IEC 60309-2. This device standard calls out a singly rated, non-interchangeable configuration for every voltage and type of service throughout the world. Pin and sleeve device housings are color coded by voltage rating.

Voltage

The voltage is determined by the location of the female ground contact relative to the housing keyway. Simply by manufacturing the device with a ground contact in a certain "clock" position, the device will be rated for a particular voltage system. The diagram shows the keying position and the color coding that is associated with each voltage.

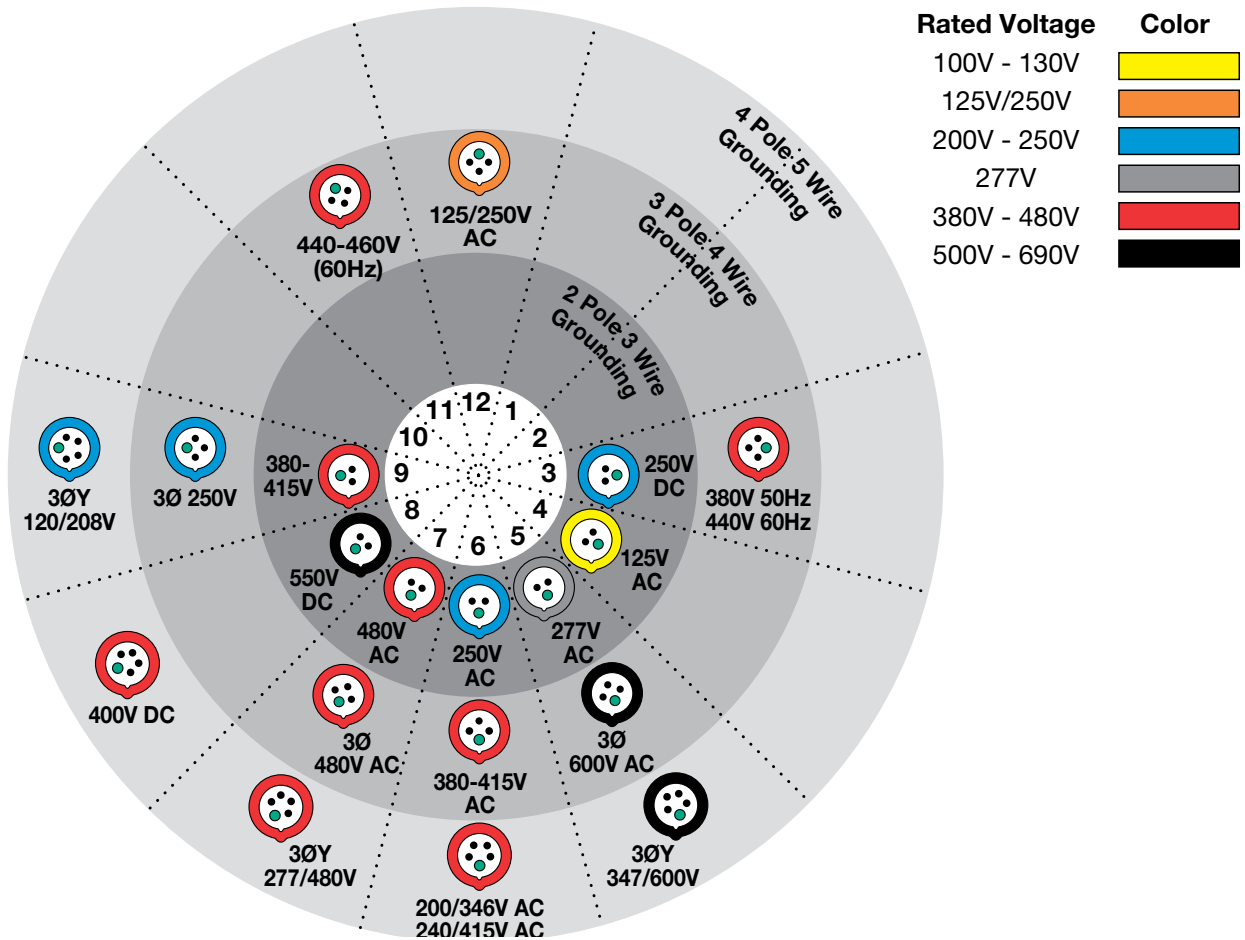

Typical IEC Pin and Sleeve Catalog Number

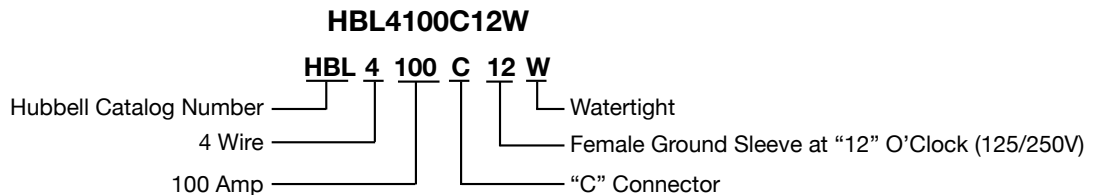

Explanation

- | | | | | | |
|---|--|--|---|--|--|
| <p>1 (HBL) Designates Hubbell Catalog Number</p> | <p>2 First Digit
3-3 wire
4-4 wire
5-5 wire</p> | <p>3 Next Series Of Digits
Preceding a letter
20-20 Amp
30-30 Amp
60-60 Amp
100-100 Amp</p> | <p>4 Letter
P-Plug
R-Receptacle
C-Connector
B-Inlet
MI-Mechanical Interlock
MIF-Mechanical Interlock Fused</p> | <p>5 Last Digit(s)
After the letter. This denotes the position of the ground sleeve and the assigned voltage in the receptacle as it relates to the hours of the clock. This is done to eliminate interchangeability between devices with different voltages.</p> | <p>6 Letter: W
Watertight</p> |
|---|--|--|---|--|--|



Features and Benefits

IP67
SUITABILITY

Watertight Devices

Hubbell's IEC 60309 Pin and Sleeve plugs, connectors, inlets and receptacles are the highest performing products available. The HBL® series of IEC pin and sleeve were designed for the demanding North American market. Hubbell was the first and is still only manufacturer of IEC 60309 devices in the USA and have numerous of innovative features noted below.

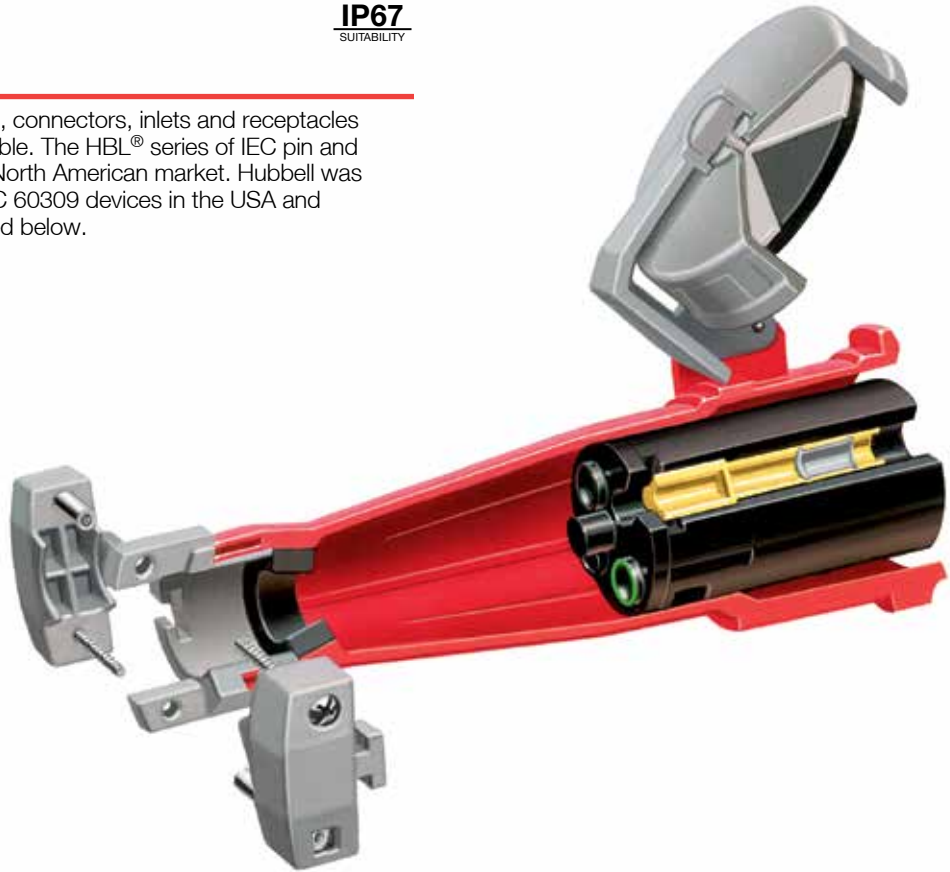

Housing Design

- Insulated non-metallic housing, super tough, non-conductive and chemical resistant for heavy duty industrial environments
- IEC pin and sleeve devices are color coded by voltage for easy identification
- Self-closing gasketed cover, detents into position to fully close automatically

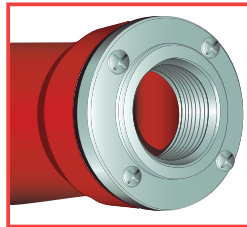

Liquidtight Conduit Adapters

- Aluminum or non-metallic adapters are available to provide a means for attaching flexible liquidtight metal conduit to rear of Hubbell Pin and Sleeve plug or connector



Powerful Mechanical Cord Grip

- Hubbell's design incorporates two molded-in teeth to securely grip the outer cable jacket, and internal conductors to prevent slippage and strain on terminations
- Captive barrel nuts ease assembly and allow higher tightening torque for maximum cord retention

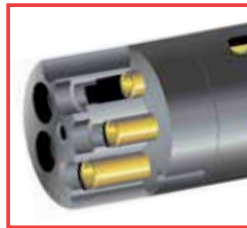

Sequential Contact Engagement

- Ground makes first and breaks last. Neutral makes second and breaks second (to prevent a momentary over-voltage on components connected phase to neutral)
- Phase contacts make last and break first



Watertight Cord Entrance

- The tapered bore entrance creates high compression forces on sealing gland, providing a watertight seal around cord
- Individual solid neoprene glands are supplied to match a full range of cord sizes and assure watertight performance

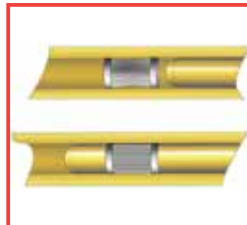

Multi-Contact Spring

- (60/63 and 100/125 Amp) Recessed within the female sleeve, provides and maintains high unit pressure on mating pins to minimize temperature rise
- Broaches oxide film to achieve low resistance contact for cooler operation

Features and Benefits

IP67
SUITABILITY

Watertight Devices

The IEC line of plugs and connectors are made with a rugged super tough, one-piece housing. The thermoset polyester contact carrier provides a high resistance to electrical tracking. They withstand higher temperatures which may result from overload or arcing. The heavy-duty, external cord grip provides superior strain relief on the conductors. Hubbell's horsepower rated plugs and receptacles meet NEC 430.109(F) requirements and recognized as an approved disconnecting/"line of sight" disconnecting means.

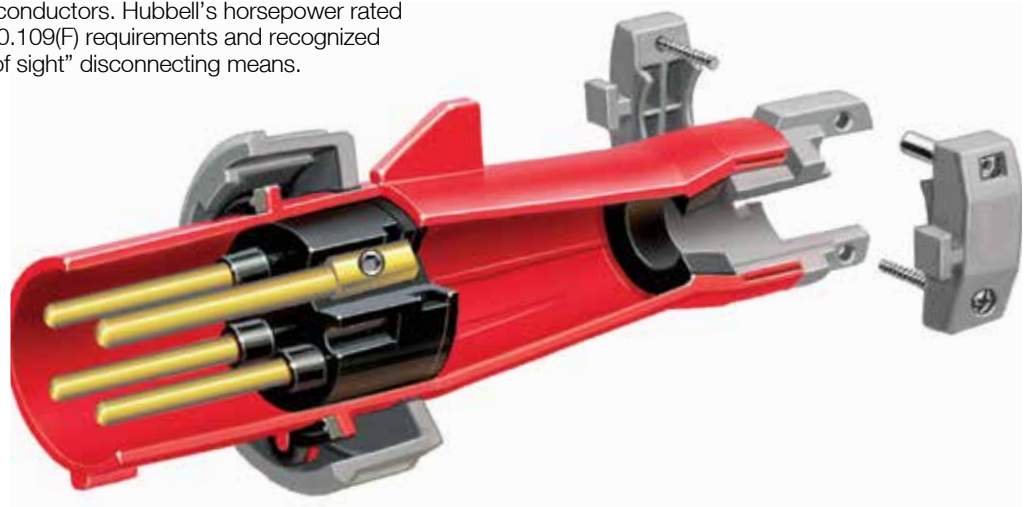

Housing Design

- Rugged one-piece housing, thick wall construction protects internal components, eliminates joints preventing infiltration of contaminants
- Amperage/voltage rating and catalog number molded in housing for easy identification



Shrouded Pins

- Super tough plug shroud protects pins from deforming from physical abuse
- Protects the user from the possibility of touching live contacts during insertion and withdrawal of mating parts
- Solid one-piece pins, machined from solid brass for longer life and reliable electrical contact



Safety

- Lockout/Tagout, tapered opening on plug shroud accommodates up to 3/8 inch (9.7mm) lock shackle diameter



Thermoset Polyester Contact Carrier

- Molded thermoset polyester provides high resistance to electrical tracking
- Withstands higher temperatures which may result from overload or arcing
- Thermoset properties provide dimensional stability for this critical assembly



Cord Grips

- Heavy duty external cord grips provide maximum cord retention to maintain secure terminations



Swivel Pressure Pads

- 16/20 and 30/32 Amp devices feature patented swiveling pressure pad terminal screws and prevent damage to conductor strands. 60/63 and 100/125 Amp devices feature large hex-head stainless steel screws which provide higher torque levels for secure terminations

















































































Rating		Watertight Devices				Accessories			Replacement Interiors			
Amps	Poles and Wires	Configuration Recept./ Plug/ Inlet	AC Voltage	Receptacle	Plug	Connector	Inlet	Back Boxes		Closure Caps	Recept./ Conn.	Plug/ Inlet
								Non-Metallic	Metallic*			
16	2P 3W		100-130V	HBL316R4W	HBL316P4W	HBL316C4W	HBL316B4W†	BB2030N	BB201W BB301W	PC320	IN320BF	IN320BM
	2P 3W		220-240V	HBL316R6W	HBL316P6W	HBL316C6W	HBL316B6W	BB2030N	BB201W BB301W	PC320	IN320BF	IN320BM
	3P 4W		380-415V	HBL416R6W	HBL416P6W	HBL416C6W	HBL416B6W†	BB2030N	BB201W BB301W	PC420	IN420DF	IN420DM
	4P 5W		220/380V 240/415V	HBL516R6W	HBL516P6W	HBL516C6W	HBL516B6W	BB2030N	BB201W BB301W	PC520	IN520EF†	IN520EM
20	2P 3W		125V	HBL320R4W	HBL320P4W	HBL320C4W	HBL320B4W	BB2030N	BB201W BB301W	PC320	IN320AF	IN320AM
	2P 3W		250V	HBL320R6W	HBL320P6W	HBL320C6W	HBL320B6W	BB2030N	BB201W BB301W	PC320	IN320BF	IN320BM
	2P 3W		480V	HBL320R7W	HBL320P7W	HBL320C7W	HBL320B7W	BB2030N	BB201W BB301W	PC320	IN320BF	IN320BM
	3P 4W		125/250V	HBL420R12W	HBL420P12W	HBL420C12W	HBL420B12W	BB2030N	BB201W BB301W	PC420	IN420CF	IN420CM
	3P 4W		3Ø 250V	HBL420R9W	HBL420P9W	HBL420C9W	HBL420B9W	BB2030N	BB201W BB301W	PC420	IN420DF	IN420DM
	3P 4W		3Ø 480V	HBL420R7W	HBL420P7W	HBL420C7W	HBL420B7W	BB2030N	BB201W BB301W	PC420	IN420DF	IN420DM
	3P 4W		3Ø 600V	HBL420R5W	HBL420P5W	HBL420C5W	HBL420B5W	BB2030N	BB201W BB301W	PC420	IN420DF	IN420DM
	4P 5W		3ØY 120/208V	HBL520R9W	HBL520P9W	HBL520C9W	HBL520B9W	BB2030N	BB201W BB301W	PC520	IN520EF†	IN520EM
	4P 5W		3ØY 277/480V	HBL520R7W	HBL520P7W	HBL520C7W	HBL520B7W	BB2030N	BB201W BB301W	PC520	IN520EF†	IN520EM
	4P 5W		3ØY 347/600V	HBL520R5W	HBL520P5W	HBL520C5W	HBL520B5W	BB2030N	BB201W BB301W	PC520	IN520EF†	IN520EM
30	2P 3W		125V	HBL330R4W	HBL330P4W	HBL330C4W	HBL330B4W	BB2030N	BB201W BB301W	PC3430	IN330AF	IN330AM†
	2P 3W		250V	HBL330R6W	HBL330P6W	HBL330C6W	HBL330B6W	BB2030N	BB201W BB301W	PC3430	IN330BF	IN330BM
	2P 3W		480V	HBL330R7W	HBL330P7W	HBL330C7W	HBL330B7W	BB2030N	BB201W BB301W	PC3430	IN330BF	IN330BM
	3P 4W		125/250V	HBL430R12W	HBL430P12W	HBL430C12W	HBL430B12W	BB2030N	BB201W BB301W	PC3430	IN430CF	IN430CM
	3P 4W		3Ø 250V	HBL430R9W	HBL430P9W	HBL430C9W	HBL430B9W	BB2030N	BB201W BB301W	PC3430	IN430DF	IN430DM
	3P 4W		3Ø 480V	HBL430R7W	HBL430P7W	HBL430C7W	HBL430B7W	BB2030N	BB201W BB301W	PC3430	IN430DF	IN430DM
	3P 4W		3Ø 600V	HBL430R5W	HBL430P5W	HBL430C5W	HBL430B5W	BB2030N	BB201W BB301W	PC3430	IN430DF	IN430DM
	4P 5W		3ØY 120/208V	HBL530R9W	HBL530P9W	HBL530C9W	HBL530B9W	BB2030N	BB201W BB301W	PC530	IN530EF	IN530EM
	4P 5W		3ØY 277/480V	HBL530R7W	HBL530P7W	HBL530C7W	HBL530B7W	BB2030N	BB201W BB301W	PC530	IN530EF	IN530EM
	4P 5W		3ØY 347/600V	HBL530R5W	HBL530P5W	HBL530C5W	HBL530B5W	BB2030N	BB201W BB301W	PC530	IN530EF	IN530EM
32	2P 3W		100-130V	HBL332R4W†	HBL332P4W†	HBL332C4W†	HBL332B4W†	BB2030N	BB201W BB301W	PC3430	IN330BF	IN330BM
	2P 3W		220-240V	HBL332R6W	HBL332P6W	HBL332C6W	HBL332B6W	BB2030N	BB201W BB301W	PC3430	IN330BF	IN330BM
	3P 4W		380-415V	HBL432R6W	HBL432P6W	HBL432C6W	HBL432B6W	BB2030N	BB201W BB301W	PC3430	IN430DF	IN430DM
	3P 4W		380V 50Hz 440V 60Hz	HBL432R3W	HBL432P3W	HBL432C3W	HBL432B3W†	BB2030N	BB201W BB301W	PC3430	IN430DF	IN430DM
	4P 5W		220/380V 240/415V	HBL532R6W	HBL532P6W	HBL532C6W	HBL532B6W	BB2030N	BB201W BB301W	PC530	IN530EF	IN530EM

Note: See page G-14 and G-15 for back boxes and accessories, G-16 and G-17 for product dimensions, G-18 and G-19 for product specifications and HP ratings.

See page G-15 for closure caps, purchased separately. PC320, PC420, PC520, PC3430, PC530 are not UL or CSA.

*These boxes are cast aluminum, suitable for IP54 requirements and are finished with enamel paint.

†Consult factory.

Rating				Watertight Devices				Accessories		Replacement Interiors			
Amps	Poles and Wires	Configuration Recep./ Conn.	Plug/ Inlet	AC Voltage	Receptacle	Plug	Connector	Inlet	Back Boxes		Closure Caps	Recep./ Conn.	Plug/ Inlet
									Non-Metallic	Metallic†			
60	2P 3W			125V 	HBL360R4W	HBL360P4W	HBL360C4W	HBL360B4W	BB60N	BB601W BB602W	PC60	IN360AF	IN360AM
	2P 3W			250V 	HBL360R6W	HBL360P6W	HBL360C6W	HBL360B6W	BB60N	BB601W BB602W	PC60	IN360BF	IN360BM†
	2P 3W			480V 	HBL360R7W	HBL360P7W	HBL360C7W	HBL360B7W	BB60N	BB601W BB602W	PC60	IN360BF	IN360BM†
	3P 4W			125/250V 	HBL460R12W	HBL460P12W	HBL460C12W	HBL460B12W	BB60N	BB601W BB602W	PC60	IN460CF	IN460CM
	3P 4W			3Ø 250V 	HBL460R9W	HBL460P9W	HBL460C9W	HBL460B9W	BB60N	BB601W BB602W	PC60	IN460DF	IN460DM
	3P 4W			3Ø 480V 	HBL460R7W	HBL460P7W	HBL460C7W	HBL460B7W	BB60N	BB601W BB602W	PC60	IN460DF	IN460DM
	3P 4W			3Ø 600V 	HBL460R5W	HBL460P5W	HBL460C5W	HBL460B5W	BB60N	BB601W BB602W	PC60	IN460DF	IN460DM
	4P 5W			3ØY 120/208V 	HBL560R9W	HBL560P9W	HBL560C9W	HBL560B9W	BB60N	BB601W BB602W	PC60	IN560EF	IN560EM†
	4P 5W			3ØY 277/480V 	HBL560R7W	HBL560P7W	HBL560C7W	HBL560B7W	BB60N	BB601W BB602W	PC60	IN560EF	IN560EM†
	4P 5W			3ØY 347/600V 	HBL560R5W	HBL560P5W	HBL560C5W	HBL560B5W	BB60N	BB601W BB602W	PC60	IN560EF	IN560EM†
63	2P 3W			220-240V 	HBL363R6W	HBL363P6W	HBL363C6W	HBL363B6W	BB60N	BB601W BB602W	PC60	IN360BFS	IN360BMS†
	3P 4W			380-415V 	HBL463R6W	HBL463P6W	HBL463C6W	HBL463B6W	BB60N	BB601W BB602W	PC60	IN460DFS	IN460DMS
	4P 5W			220/380V 240/415V 	HBL563R6W	HBL563P6W	HBL563C6W	HBL563B6W	BB60N	BB601W BB602W	PC60	IN560EFS†	IN560EMS
100	2P 3W			125V 	HBL3100R4W	HBL3100P4W	HBL3100C4W	HBL3100B4W	BB100N	BB1001W BB1002W	PC100	IN3100AF	IN3100AM
	2P 3W			250V 	HBL3100R6W	HBL3100P6W	HBL3100C6W	HBL3100B6W	BB100N	BB1001W BB1002W	PC100	IN3100BF	IN3100BM†
	2P 3W			480V 	HBL3100R7W	HBL3100P7W	HBL3100C7W	HBL3100B7W	BB100N	BB1001W BB1002W	PC100	IN3100BF	IN3100BM†
	3P 4W			125/250V 	HBL4100R12W	HBL4100P12W	HBL4100C12W	HBL4100B12W	BB100N	BB1001W BB1002W	PC100	IN4100CF†	IN4100CM
	3P 4W			3Ø 250V 	HBL4100R9W	HBL4100P9W	HBL4100C9W	HBL4100B9W	BB100N	BB1001W BB1002W	PC100	IN4100DF	IN4100DM
	3P 4W			3Ø 480V 	HBL4100R7W	HBL4100P7W	HBL4100C7W	HBL4100B7W	BB100N	BB1001W BB1002W	PC100	IN4100DF	IN4100DM
	3P 4W			3Ø 600V 	HBL4100R5W	HBL4100P5W	HBL4100C5W	HBL4100B5W	BB100N	BB1001W BB1002W	PC100	IN4100DF	IN4100DM
	4P 5W			3ØY 120/208V 	HBL5100R9W	HBL5100P9W**	HBL5100C9W	HBL5100B9W	BB100N	BB1001W BB1002W	PC100	IN5100EF	IN5100EM
	4P 5W			3ØY 277/480V 	HBL5100R7W	HBL5100P7W	HBL5100C7W	HBL5100B7W	BB100N	BB1001W BB1002W	PC100	IN5100EF	IN5100EM
	4P 5W			3ØY 347/600V 	HBL5100R5W	HBL5100P5W	HBL5100C5W	HBL5100B5W	BB100N	BB1001W BB1002W	PC100	IN5100EF	IN5100EM
125	2P 3W			220-240V 	HBL3125R6W	HBL3125P6W	HBL3125C6W	HBL3125B6W	BB100N	BB1001W BB1002W	PC100	IN3100BFS†	IN3100BMS†
	3P 4W			380-415V 	HBL4125R6W	HBL4125P6W	HBL4125C6W	HBL4125B6W	BB100N	BB1001W BB1002W	PC100	IN4100DFS	IN4100DMS
	4P 5W			220/380V 240/415V 	HBL5125R6W	HBL5125P6W	HBL5125C6W	HBL5125B6W	BB100N	BB1001W BB1002W	PC100	IN5100EFS	IN5100EMS

Note: See page G-14 and G-15 for back boxes and accessories, G-16 and G-17 for product dimensions, G-18 and G-19 for product specifications and HP ratings.

All 63A and all 125A devices have pilot pins or contacts.

See page G-15 for closure caps, purchased separately. PC60 and PC100 are not UL or CSA.

*These boxes are cast aluminum, suitable for IP54 requirements and are finished with enamel paint.

**Short housing plug HBL5100P9WSH. IP22 suitability.

†Consult factory.



Hubbell's Pin and Sleeve connections have always been safe – that hasn't changed. The Advantage™ series simply has more... Advantages.

IEC 60309 Singalarly Rated Device

Mates with existing installed base of IEC 60309-2 pin and sleeve devices. Color coded by voltage for easy identification of mating devices.

Superior Water Ingress Protection

UL witnessed IP69k and UL Type 4X and 12. Device is built to withstand wet and harsh environments.

Power Indicating LED Lights

Highly visible and long lasting green LED lights on both sides of the device provide visual verification of power when connected.

Continuous Ground Engagement

Unswitched feed-through ground pin is first-to-make and last-to-break followed by switched neutral and phase contact(s).

Permanent Labelless Markings

Product ratings are laser-marked into the device and will not wash off for easy permanent identification.

Sleek and Modern Design

The ergonomic device is easy to keep clean making it ideal for hygienic food processing facilities.

The Advantage™ Series has a UL witnessed IP69k and 4X,12 environmental rating, two power-indicating LEDs, continuous ground engagement, labelless laser markings and a compact and ergonomic design.



Features and Benefits

Advantage™ Series Pin and Sleeve Switch-Rated

Hubbell Wiring Device-Kellems Advantage™ Series Pin and Sleeve Switch-Rated Devices are IEC 60309-2 compatible devices that are approved as a disconnecting means for motor and branch circuits. Compact design, this device is similar in size to standard IEC 60309-2 devices. Robust and durable housing, UV-stabilized, impact and corrosion-resistant PBT housing is designed to withstand harsh industrial environments. Stainless steel hardware provides superior corrosion resistance in wet and harsh environments. Receptacles mount to standard Hubbell IEC Pin and Sleeve back boxes.



Housing Design

- Rugged one-piece housing, thick wall construction protects internal components, eliminates joints preventing infiltration of contaminants
- IEC pin and sleeve devices are color coded by voltage for easy identification



Heavy Duty External Cord Grips

- Provides maximum cord retention to maintain unstressed terminations
- Pocketed recess for screws deters slippage of the screwdriver and are conveniently located on the same side for easy installation



Safety

- Ergonomic design puts the Advantage™ into the palm of your hands with the easy-to-use leverage grip design from Hubbell



Spring-Loaded Cover

- Spring-loaded to the open position, reminding users that the cover must be secured to ensure maximum ingress protection
- Impact resistant cover arm compact and durable internal swing arm is fully shrouded protecting it from damage



Spring-Loaded Disconnect Button

- Oversized for easy actuation with gloved hands



Power Indicating LED Lights

- Provides visual verification of power when connected

Rating				Pin and Sleeve Devices					Accessories		
Amps	Poles and Wires	Configuration Recept./ Conn.	Plug/ Inlet	AC Voltage	Connector	Receptacle	HP	Mating Plug**	IP67 Inlet	Back Boxes	Closure Caps
30	2P 3W			125V			2				
32	2P 3W			100–130V			2				
30	2P 3W			250V			5				
32	2P 3W			220–240V							
30	2P 3W			480V			10				
30	3P 4W			125/250V			2				
30/32	3P 4W			3Ø 250V			10				
30	3P 4W			3Ø 480V			20				
30	3P 4W			3Ø 600V			30				
30/32	3P 4W			380–415V			7.5				
32	3P 4W			380–440V			10				
30	4P 5W			3ØY 347/600V			30				
30	4P 5W			200/346–240/415V			7.5				
32	4P 5W			220/380V 240/415V							
30	4P 5W			3ØY 277/480V			20				
30/32	4P 5W			3ØY 120/208V			10				

Note: *Certain IEC configurations allow for a single product to be certified as both a North American (Series 2) and International amperage (Series 1). These products are marked accordingly with both the UL Listing and UL Classified markings.

**Mating plug required to maintain 4X/IP69k ratings when used with ADVANTAGE™ Series Connections.

ADVANTAGE™ Series Receptacles have the same mounting pattern as standard Hubbell IEC pin and sleeve.

Materials

Part	Material	Connector	Receptacle	Plug/Inlet
Cover	Valox®	X	X	
Cover Gasket	Neporene	X	X	
Housing	Valox®	X	X	X
Gasket	Santoprene	X	X	X
Female Contact Carrier	Nylon	X	X	
Male Contact Carrier	Thermoset			X
Phase, Ground Sleeves	Brass	X	X	
Sleeve Springs	Beryllium Copper with Silver Plating	X	X	
Pins	Brass			X
Glands	Solid Neoprene	X		X
Cord Clamps	Valox®	X		X
Clamp Nut	Nickel-Plated Brass	X		X
Screws	Stainless Steel (300 Series)	X	X	X
Locking Ring	Valox®			X
Switch Contacts	Laminated Silver	X	X	

Valox® is a trademark of SABIC Innovative Plastics, acquired from General Electric Company.

Specifications

Temperature Rise	< 30°C
Dielectric Voltage	Min 2,200V AC
Electrical Life	Min 6,000 Cycles at rated switch load (p.f.= .75-.80)
Max Working Voltage	600V AC
Current Interrupting	Certified for current interrupting at full rated current and voltage
Horsepower Locked Rotor Test	50 Operations at 600% of full load motor current (p.f.= .40-.50)
Short Circuit	100kA when protected by 100A Class J fuse or 125A RK1 fuse
Endurance	Min 10,000 mating cycles
Flammability	HB or Better per UL 94 or CSA C22.2 No. 0.17
Operating Temperature	Max Continuous +75°C; Min continuous -40°C
Environmental	Type 4X, 12 and IP69k
UV Resistance	All materials are UV stabilized

Rating		Pin and Sleeve Devices						Accessories			
Amps	Poles and Wires	Configuration Recep./ Conn.	Plug/ Inlet	AC Voltage	Connector	Receptacle	HP	Mating Plug**	Inlet**	Back Boxes	Closure Caps
60	2P 3W			125V			3				
60	2P 3W			250V							
63	2P 3W			220-240V							
60	2P 3W			480V							
60	3P 4W			125/250V							
60/63	3P 4W			3Ø 250V							
60	3P 4W			3Ø 480V							
60	3P 4W			3Ø 600V							
60/63	3P 4W			380-415V							
60	4P 5W			3ØY 347/600V							
60/63	4P 5W			200/346-240/415V							
60	4P 5W			3ØY 277/480V							
60/63	4P 5W			3ØY 120/208V							

Note: *Certain IEC configurations allow for a single product to be certified as both a North American (Series 2) and International amperage (Series 1). These products are marked accordingly with both the UL Listing and UL Classified markings.

**Mating plug or inlet required to maintain 4X/IP69k ratings when used with ADVANTAGE™ Series Connections. ADVANTAGE™ Series Receptacles have the same mounting pattern as standard Hubbell IEC pin and sleeve. Just add a "P" suffix for Pilot pin for 60 amp devices.

Optional Pilot Pin Available on All 60A Devices

The Pilot Pin is smaller than the ground and phase pins and are designed to make after main and break before main breaks. This pin can be used to communicate with auxiliary devices within your facility. They are "Break before main break" and by design are the last contact in the sequence to make and first to break.



Rating			Pin and Sleeve Devices			
Amps	Poles/Wires	AC Voltage	Connector with Pilot Sleeve	Receptacle with Pilot Sleeve	Plug with Pilot Pin	Inlet with Pilot Pin
60/63	3P 4W	3Ø 250V	HBLS460C9WP*	HBLS460R9WP*	HBLS460P9WP*	HBLS460B9WP*

Note: *Just add a "P" suffix for Pilot pin for 60 amp devices.

Dimensions

Description	A		B		C		D		E		F		G	
	Connector		Receptacle		Receptacle		Receptacle		Receptacle		Receptacle		Receptacle	
30A	9.9"	(251.5)	4.5"	(114.3)	1.06"	(27.2)	3.83"	(97.3)	3.13"	(79.4)	3.75"	(95.2)	4.5"	(114.3)
60A	12.22"	(310.4)	5.17"	(131.3)	1.85"	(47.0)	4.77"	(121.2)	3.88"	(98.6)	4.52"	(114.8)	5.09"	(129.3)

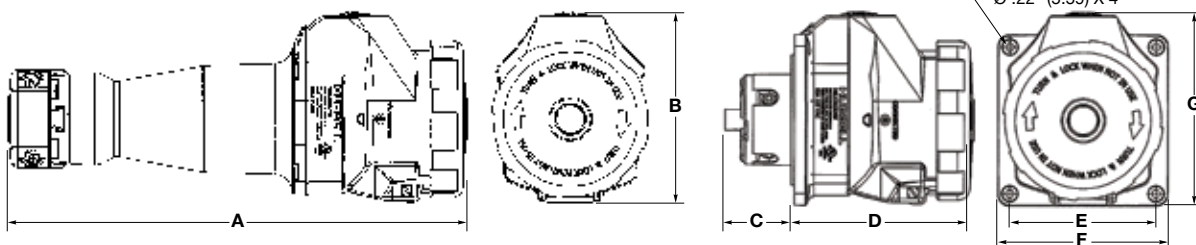

Dimensions in Inches (mm)



IP67
SUITABILITY



Corrosion Resistant Devices that Withstand the Most Abusive Environments

Hubbell offers a superior grade of 100A IEC Pin and Sleeve designed for use in the most demanding environments. These devices feature nickel plated solid brass pins for long life and reliable electrical contact in the most corrosive environments. They have a high visibility yellow supertough nylon housing. The heavy duty external cord clamps provide maximum cord retention to maintain secure terminations. The screws and fasteners are made from stainless steel.



- Food Processing
- Factory

- Water Treatment
- Washdown
- Temporary Power

- Meat Packing
- Construction

- Agriculture
- Outdoor Entertainment

Standard Service

Rating						Watertight Devices			Accessories		
Amps	Poles And Wires	Configuration Recept./ Conn.	Plug	AC Voltage		Receptacle	Plug	Connector	Back Boxes Non-Metallic	Back Boxes Metallic*	Closure Caps
100	3P 4W			125/250V		M4100R12	M4100P12	M4100C12	BB100N	BB1001W BB1002W	PC100
	4P 5W			3ØY 120/208V		M5100R9	M5100P9	M5100C9	BB100N	BB1001W BB1002W	PC100
	4P 5W			3ØY 277/480V		M5100R7	M5100P7	M5100C7	BB100N	BB1001W BB1002W	PC100

"Reverse Service"

Rating						Watertight Devices			Accessories		
Amps	Poles And Wires	Configuration Conn.	Inlet	AC Voltage		Inlet	Plug	Connector	Back Boxes Non-Metallic	Back Boxes Metallic*	Closure Caps
100	3P 4W			125/250V		M4100B12R	—	M4100C12R	BB100N	BB1001W BB1002W	PC100
	4P 5W			3ØY 120/208V		M5100B9R	—	M5100C9R	BB100N	BB1001W BB1002W	PC100
	4P 5W			3ØY 277/480V		M5100B7R	—	M5100C7R	BB100N	BB1001W BB1002W	PC100

Note: *These boxes are cast aluminum, suitable for IP54 requirements and are finished with enamel paint. See page Y-17 for corrosion resistant cord sets.



Data Center DC Rated Pin and Sleeve Devices

IP67
SUITABILITY



In today's environmentally conscious world, energy savings is a pinnacle part of going green. DC (Direct Current) is being used to reduce power consumption and decrease the amount of infrastructure needed to energize specific types of data center equipment. Electrical devices provide a means of connecting DC power.

Hubbell is the first manufacturer to introduce a series of IEC Pin and Sleeve devices configured for the UL1686 eight o'clock ground position for DC voltage (Disconnecting use only). Hubbell's IEC DC rated pin and sleeve line has been qualified by UL to the requirements of DC voltage. The thermoset polyester contact carrier provide high resistance to electrical tracking, it withstands higher temperatures for this type of demanding application. The solid one-piece pins are machined from solid brass for longer life and reliable electrical contact. In addition, the heavy-duty external cord grips provide maximum cord retention to maintain secure terminations. Finally, the super tough, color coded, non-conductive V-0 rated Valox® housing is heavy duty for safety and protecting the internal components.



Rating					Watertight Devices		
Amps	Poles And Wires	Configuration Recep./ Conn.	Plug	DC Voltage	Receptacle	Plug	Connector
30	2P 3W			550V ■			
60	2P 3W			550V ■			
100	2P 3W			550V ■			
	4P 5W			400V ■			

Note: *Inlet available - HBL360B8WDC.

Dual Certified Pin and Sleeve Devices

IP67
SUITABILITY



Hubbell's dual certified pin and sleeve devices are ideal for the data center and high tech server industry. They are UL Listed to UL1682 for the North American market and are TUV Rheinland Certified for the European and International market. Customers can use the same plug and connector for multiple electrical configurations. They reduce the number of SKU's end users have to use if they sell to both domestic and overseas customers. These devices are IP67 rated, RoHs compliant and showcase all the inherent safety benefits of their V-0 rated Valox® housing and internal components.

Rating					Watertight Devices			
Amps	Poles And Wires	Configuration Recep./ Conn.	Plug	AC Voltage	Receptacle	Plug	Connector	Inlet
30/32	3P 4W			380-415V ■				
	4P 5W			200/346V 240/415V ■				
60/63	3P 4W			380-415V ■				
	4P 5W			200/346V 240/415V ■				

Valox® is a trademark of SABIC Innovative Plastics, acquired from General Electric Company.



BB60N



BB601W



FW6010055



FT202W



FW60100



HBL2030AP



AA2030PS

Back Boxes

Hubbell manufactures an extensive line of back boxes for use with IEC Pin and Sleeve devices. Each back box is designed to give the user the maximum amount of wiring room while achieving grounding to metallic conduit. Hubbell back boxes are available in non-metallic and cast metal versions.

Non-Metallic 15° Angle Back Box

Description	NPT Hub Size*	Catalog Number
Back box for 16, 20, 30 and 32A devices.	1"	BB2030N
Back box for 60 and 63A devices.	1¼"	BB60N
Back box for 100 and 125A devices.	1½"	BB100N

Note: *Hub is not included; order one of the following Racor® part numbers: 1 in. = 1704, 1¼ in. = 1705, 1½ in. = 1706. These boxes meet IP67 requirement and Type 4X requirements when installed with a watertight conduit hub.

Metallic 15° Angle Back Box and Adapter**

Description	NPT Hub Size	Catalog Number
Back box for 16, 20, 30 and 32A devices.	¾"	BB201W
	1"	BB301W
Back box for 60 and 63A devices.	1¼"	BB601W
	1½"	BB602W
Back box for 100 and 125A devices.	1½"	BB1001W
	2"	BB1002W
Angle adapter only for 60, 63, 100 and 125A devices.	–	AA6010015

Note: **These boxes are cast aluminum, suitable for IP54 requirements and are finished with enamel paint.

Metallic 55° Angle Back Box and Adapter**

Description	NPT Hub Size	Catalog Number
Feed-thru box back box and adapter for 16, 20, 30 and 32A devices.	1"	AB203055
Angle adapter only.	–	AA203055
Back box and adapter for 60, 63, 100 and 125A devices.	1½"	FW6010055
Angle adapter only.	–	AA6010055

Note: **These boxes are cast aluminum, suitable for IP54 requirements and are finished with enamel paint.

Metallic Feed-Thru Back Box**

Description	NPT Hub Size	Catalog Number
Feed-thru box for 16, 20, 30 and 32A devices.	¾"	FT202W
	1"	FT302W

Note: **These boxes are cast aluminum, suitable for IP54 requirements and are finished with enamel paint.

Metallic Four-Way 15° Angle Back Box**

Description	NPT Hub Size	Catalog Number
Four-way box for 60, 63, 100 and 125A devices.	1½"	FW60100

Note: **These boxes are cast aluminum, suitable for IP54 requirements and are finished with enamel paint.

Straight Wall Box Adapter

Description	Catalog Number
Adapts 16, 20, 30 and 32A Watertight IEC Pin and Sleeve devices to 2-gang, device boxes and FD boxes.	HBL2030AP

Angle Wall Box Adapter

Description	Catalog Number
Adapts 16, 20, 30 and 32A Watertight IEC Pin and Sleeve devices to standard wall boxes.	AA2030PS

Note: Adapts 20 and 30A Watertight Pin and Sleeve receptacle to single, 2-gang standard wall box and 4 or 4¼ inch square for non-watertight applications.



Accessories

Closure Caps

Cap assemblies provide watertight sealing to a disconnected male IEC Pin and Sleeve plug or inlet. Manufactured of the same tough non-metallic material as the watertight IEC Pin and Sleeve devices for corrosion and abuse resistance.

Description	Catalog Number
Fits all 16 and 20A, 3 wire plugs and inlets.	PC320
Fits all 16 and 20A, 4 wire plugs and inlets.	PC420
Fits all 16 and 20A, 5 wire plugs and inlets.	PC520
Fits all 30 and 32A, 3 and 4 wire plugs and inlets.	PC3430
Fits all 30 and 32A, 5 wire plugs and inlets.	PC530
Fits all 60 and 63A plugs and inlets.	PC60
Fits all 100 and 125A plugs and inlets.	PC100



PC3430

Cover Assemblies

Replacement cover assemblies for use with watertight connector bodies and receptacles. Kit contains cover, arm assembly and installation tool.

Description	Catalog Number
Fits all 16 and 20A, 3 wire watertight female devices.	CA320
Fits all 16 and 20A, 4 wire watertight female devices.	CA420
Fits all 16 and 20A, 5 wire watertight female devices.	CA520
Fits all 30 and 32A, 3 and 4 wire watertight female devices.	CA3430
Fits all 30 and 32A, 5 wire watertight female devices.	CA530
Fits all 60 and 63A watertight female devices.	CA60
Fits all 100 and 125A watertight female devices.	CA100



CA3430

Cord Clamp and Locking Ring

Replacement cord clamp and locking ring for use with IEC plugs, connectors and inlets.

Description	Cord Clamp and Locking Ring	Locking Ring Only
Fits all 16 and 20A, 3 wire plugs, connectors and inlets.	CC320	LR320*
Fits all 16 and 20A, 4 wire plugs, connectors and inlets.	CC420	LR420*
Fits all 16 and 20A, 5 wire plugs, connectors and inlets.	CC520†	LR520*
Fits all 30 and 32A, 3 and 4 wire plugs, connectors and inlets.	CC3430	LR3430*
Fits all 30 and 32A, 5 wire plugs, connectors and inlets.	CC530†	LR530*
Fits all 60 and 63A plugs, connectors and inlets.	CC60	LR60*
Fits all 100 and 125A plugs, connectors and inlets.	CC100	LR100*

Note: *Locking Ring only for plugs and inlets.

†Consult factory.



CC3430

LR3430

Liquidtight Adapters

Machined aluminum adapters are available to provide a means for attaching flexible liquidtight metal conduit to rear of a Hubbell Pin and Sleeve plug or connector. To install, remove cord grip and two gland cap screws. Use screws to attach adapter. Kellems® liquidtight conduit connectors are available to control arc of bend and to prevent conduit pull-out where vibration, motion or strain is present. These grips interface directly with Hubbell's liquidtight adapters and are available in a wide variety of NPT sizes and configurations. Consult your local code grounding requirements before using liquidtight adapters.

Rating of Hubbell Pin and Sleeve Device	Liquidtight Conduit Size	Liquidtight Adapters		Optional Kellems Liquidtight Conduit Grip
		Aluminum	Non-Metallic	
16 and 20 Amp 3 and 4 Wire	½" NPT	SAA12	—	074093402
	¾" NPT	SAA34	—	074093403
16 and 20 Amp 5 wire and 30 and 32 Amp 3 and 4 wire	½" NPT	SAB12	—	074093402
	¾" NPT	SAB34	—	074093403
	1" NPT	SAB100	—	074093404
30 and 32 Amp 5 wire and 60 and 63 Amp (all)	½" NPT	SAC12	SAC12NM	074093402
	¾" NPT	SAC34	SAC34NM	074093403
	1" NPT	SAC100	SAC100NM	074093404
	1¼" NPT	SAC125	—	074093405
100 and 125 Amp (all)	1¼" NPT	SAD125	—	074093405
	1½" NPT	SAD150	—	074093406



SAB34



074093403

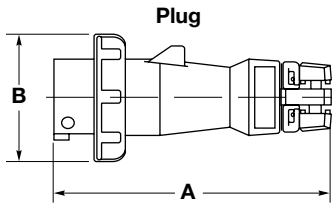

Plug Dimensions

Type	A	B	Cord Grip Range
HBL320P	6.61" (167.8)	2.87" (73.0)	.330"-.830" (8.4-21.1)
HBL420P	7.00" (177.8)	3.19" (81.0)	.330"-.830" (8.4-21.1)
HBL520P	7.65" (194.3)	3.50" (89.0)	.330"-.830" (8.4-21.1)
HBL330P	8.05" (204.5)	3.74" (95.0)	.375"-1.250" (9.5-31.8)
HBL430P	8.05" (204.5)	3.74" (95.0)	.375"-1.250" (9.5-31.8)
HBL530P	8.54" (216.9)	4.02" (102.0)	.500"-1.450" (12.7-36.8)
HBL360P, HBL460P, HBL560P	10.15" (257.8)	4.49" (114.0)	.500"-1.450" (12.7-36.8)
HBL3100P, HBL4100P, M4100P, HBL5100P, M5100P	12.63" (320.8)	4.92" (125.0)	1.065"-1.940" (27.1-49.3)

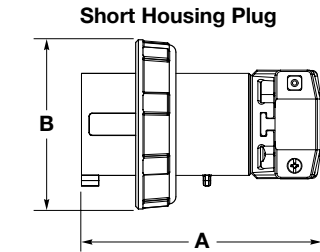

Short Housing Plug Dimensions

Type	A	B	Cord Grip Range
HBL5100P9WSH	8.30" (210.82)	4.92" (125.0)	1.065"-1.940" (27.1-49.3)

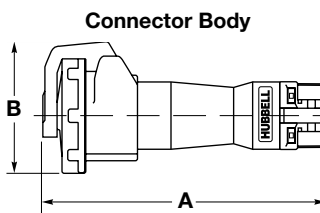

Connector Body Dimensions

Type	A	B	Cord Grip Range
HBL320C	7.49" (190.3)	3.33" (84.6)	.330"-.830" (8.4-21.1)
HBL420C	7.90" (200.6)	3.66" (93.0)	.330"-.830" (8.4-21.1)
HBL520C	8.54" (216.9)	3.94" (100.0)	.330"-.830" (8.4-21.1)
HBL330C	9.05" (229.9)	4.27" (108.5)	.375"-1.250" (9.5-31.8)
HBL430C	9.05" (229.9)	4.27" (108.5)	.375"-1.250" (9.5-31.8)
HBL530C	9.68" (245.8)	4.70" (119.5)	.500"-1.450" (12.7-36.8)
HBL360C, HBL460C, HBL560C	11.15" (283.2)	5.10" (129.5)	.500"-1.450" (12.7-36.8)
HBL3100C, HBL4100C, M4100C, HBL5100C, M5100C	13.57" (344.7)	5.71" (145)	1.065"-1.940" (27.1-49.3)

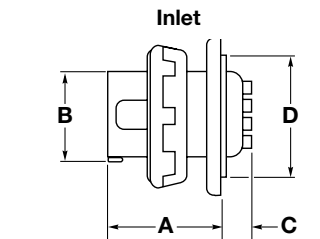

Inlet Dimensions

Type	A	B	C	D	E	F
HBL320B	2.54" (64.5)	1.85" (47.0)	1.14" (29.0)	2.72" (69.0)	3.75" (95.3)	3.13" (79.5)
HBL420B	2.54" (64.5)	2.11" (53.6)	1.14" (29.0)	2.72" (69.0)	3.75" (95.3)	3.13" (79.5)
HBL520B	2.54" (64.5)	2.41" (61.2)	1.14" (29.0)	2.72" (69.0)	3.75" (95.3)	3.13" (79.5)
HBL330B	2.99" (76.0)	2.49" (63.2)	1.04" (26.5)	2.72" (69.0)	3.75" (95.3)	3.13" (79.5)
HBL430B	2.99" (76.0)	2.49" (63.2)	1.04" (26.5)	2.72" (69.0)	3.75" (95.3)	3.13" (79.5)
HBL530B	2.99" (76.0)	2.75" (69.9)	1.04" (26.5)	2.80" (71.0)	3.75" (95.3)	3.13" (79.5)
HBL360B, HBL460B, HBL560B	4.04" (102.6)	2.97" (75.5)	1.18" (30.0)	3.46" (88.0)	4.50" (114.3)	3.88" (98.5)
HBL3100B, HBL4100B, M4100B, HBL5100B, M5100B	4.53" (115)	3.44" (87.5)	1.95" (49.5)	3.94" (100.0)	5.50" (139.7)	4.88" (124.0)

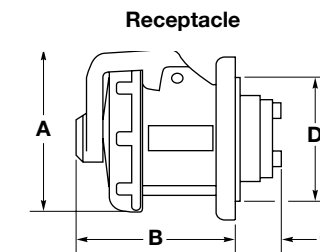
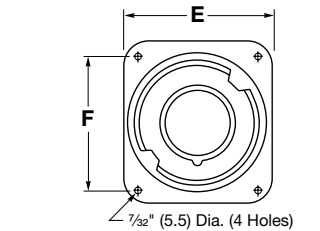

Receptacle Dimensions

Type	A	B	C	D	E	F
HBL320R	3.33" (84.5)	2.78" (70.6)	1.02" (26.0)	2.72" (69.0)	3.75" (95.3)	3.13" (79.5)
HBL420R	3.66" (93.0)	2.78" (70.6)	1.02" (26.0)	2.72" (69.0)	3.75" (95.3)	3.13" (79.5)
HBL520R	3.94" (100.0)	2.78" (70.6)	1.02" (26.0)	2.72" (69.0)	3.75" (95.3)	3.13" (79.5)
HBL330R	4.27" (108.5)	3.09" (78.5)	1.16" (29.5)	2.72" (69.0)	3.75" (95.3)	3.13" (79.5)
HBL430R	4.27" (108.5)	3.09" (78.5)	1.16" (29.5)	2.72" (69.0)	3.75" (95.3)	3.13" (79.5)
HBL530R	4.70" (119.4)	3.09" (78.5)	1.16" (29.5)	2.83" (71.9)	3.75" (95.3)	3.13" (79.5)
HBL360R, HBL460R, HBL560R	5.10" (129.5)	4.07" (103.4)	1.69" (43.0)	3.46" (88.0)	4.50" (114.3)	3.88" (98.6)
HBL3100R, HBL4100R, M4100R, HBL5100R, M5100R	5.71" (145)	4.23" (107.4)	2.46" (62.5)	3.95" (100.3)	5.50" (139.7)	4.88" (123.9)

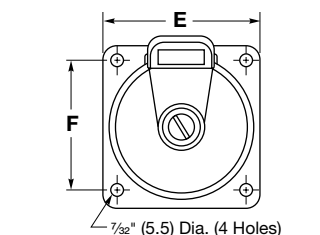

Note: 20, 30, 60 and 100A devices are dimensionally equivalent to 16, 32, 63 and 125A devices, respectively.

Dimensions in Inches (mm)



Non-Metallic 15° Angle Back Box

Description	NPT Hub Size	A Inch (mm)	B Inch (mm)	C Inch (mm)	D Inch (mm)	E Inch (mm)	F Inch (mm)	Cubic Inch Capacity	Catalog Number
Back box for 16, 20, 30 & 32A devices.	1"	5.67" (144.0)	4.44" (112.8)	4.05" (102.9)	3.91" (99.3)	2.35" (59.7)	4.92" (125.0)	30.00"	BB2030N
Back box for 60 & 63A devices.	1¼"	7.76" (197.0)	5.16" (131.0)	5.87" (149.0)	4.72" (120.0)	2.99" (76.0)	6.94" (176.0)	70.00"	BB60N
Back box for 100 & 125A devices.	1½"	8.21" (209.0)	6.23" (158.0)	6.31" (160.3)	5.71" (145.0)	3.99" (101.0)	7.41" (188.0)	120.00"	BB100N

Note: *Hub is not included; order one of the following **Raco®** part numbers: 1 inch = 1704, 1¼ inch = 1705, 1½ inch = 1706. These boxes meet IP67 requirement and Type 4X requirements when installed with a watertight conduit hub.

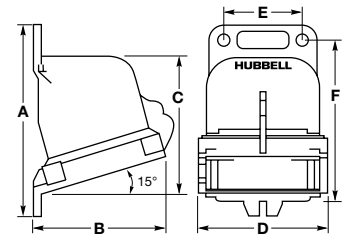

Non-Metallic Angle Box

Metallic 15° Angle Back Box

Description	NPT Hub Size	A Inch (mm)	B Inch (mm)	C Inch (mm)	D Inch (mm)	E Inch (mm)	F Inch (mm)	Cubic Inch Capacity	Catalog Number
Back box for 16, 20, 30 & 32A devices.	¾"	5.12" (130.2)	4.00" (101.6)	4.19" (106.4)	3.75" (95.3)	3.00" (76.2)	4.00" (101.6)	30.00"	BB201W
Back box for 16, 20, 30 & 32A devices.	1"	5.12" (130.2)	4.00" (101.6)	4.19" (106.4)	3.75" (95.3)	3.00" (76.2)	4.00" (101.6)	30.00"	BB301W
Back box for 60 & 63A devices.	1¼"	7.25" (184.2)	5.25" (133.4)	6.00" (152.4)	4.50" (114.3)	3.75" (95.3)	6.19" (157.2)	80.00"	BB601W
Back box for 60 & 63A devices.	1½"	7.25" (184.2)	5.25" (133.4)	6.00" (152.4)	4.50" (114.3)	3.75" (95.3)	6.19" (157.2)	80.00"	BB602W
Back box for 100 & 125A devices.	1½"	8.12" (206.4)	6.75" (171.5)	6.88" (174.6)	5.50" (139.7)	4.75" (120.7)	6.94" (176.2)	130.00"	BB1001W
Back box for 100 & 125A devices.	2"	8.12" (206.4)	6.75" (171.5)	6.88" (174.6)	5.50" (139.7)	4.75" (120.7)	6.94" (176.2)	130.00"	BB1002W

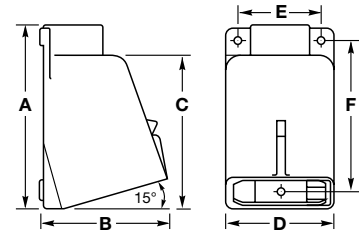

Metallic 15° Angle Box

Metallic 55° Angle Back Box and Adapter

Description	NPT Hub Size	A Inch (mm)	B Inch (mm)	C Inch (mm)	D Inch (mm)	E Inch (mm)	F Inch (mm)	Cubic Inch Capacity	Catalog Number
Feed-thru box and angle adapter for 16, 20, 30 & 32A devices.	1"	6.80" (172.4)	6.60" (167.0)	5.63" (142.9)	4.50" (114.3)	3.74" (95.0)	–	42.27"	AB203055
Angle adapter for 16, 20, 30 & 32A devices.	–	4.89" (124.3)	3.33" (84.6)	4.29" (109.0)	3.75" (95.2)	2.50" (63.5)	–	25.00"	AA203055
Back box and angle adapter for 60, 63, 100 & 125A devices.	1½"	8.50" (215.9)	8.00" (202.9)	7.75" (196.8)	6.90" (174.8)	6.00" (152.4)	–	100.00"	FW6010055
Angle adapter for 60, 63, 100 & 125A devices.	–	6.75" (171.4)	4.48" (113.7)	6.00" (152.4)	6.75" (171.4)	6.00" (152.4)	–	79.00"	AA6010055

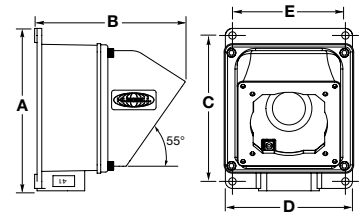

Metallic 55° Angle Box

Metallic Feed-Thru Back Box

Description	NPT Hub Size	A Inch (mm)	B Inch (mm)	C Inch (mm)	D Inch (mm)	E Inch (mm)	F Inch (mm)	Cubic Inch Capacity	Catalog Number
Feed-thru box for 16, 20, 30 & 32A devices.	¾"	8.25" (209.6)	3.06" (77.8)	7.14" (181.4)	4.50" (114.3)	3.75" (95.3)	3.13" (79.5)	48.00"	FT202W
Feed-thru box for 16, 20, 30 & 32A devices.	1"	8.25" (209.6)	3.06" (77.8)	7.14" (181.4)	4.50" (114.3)	3.75" (95.3)	3.13" (79.5)	48.00"	FT302W

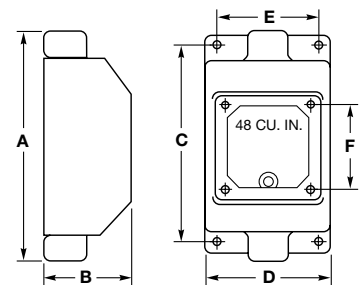

Metallic Feed-Thru Box

Metallic Four-Way 15° Angle Back Box

Description	NPT Hub Size	A Inch (mm)	B Inch (mm)	C Inch (mm)	D Inch (mm)	E Inch (mm)	F Inch (mm)	Cubic Inch Capacity	Catalog Number
Four-way box for 60, 63, 100 & 125A devices.	1½"	8.75" (222.3)	9.75" (247.7)	7.75" (196.9)	6.75" (171.5)	6.00" (152.4)	–	210.00"	FW60100

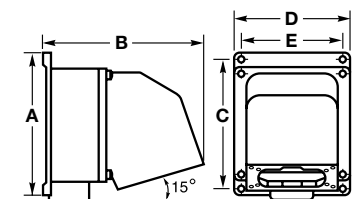

Metallic Four-Way Angle Box

Note: These boxes are cast aluminum, suitable for IP54 requirements and are finished with enamel paint. These boxes withstand a 500-hour salt spray test as well as UL rain tight and external icing test.

Dimensions in Inches (mm)



Watertight Materials

Part	Material
Inlet	
Housing	Zytel® 101 Nylon
Locking Ring	Reinforced Thermoplastic Polyester
Mounting Flange	Zytel® 101 Nylon
Mounting Screws	Stainless Steel (300 Series)
Contact Carrier	High-Impact Thermoset
Retainer	High-Impact Thermoset
Ground, Phase Pins	Brass (M-Series - Nickel-plated brass)
Terminal Screws	Stainless Steel (300 Series)
Assembly Screws (2)	Stainless Steel (300 Series)
Gaskets	Solid Neoprene
Connector Body	
Housing	Zytel® ST801 Nylon
Cord Clamps	Reinforced Thermoplastic Polyester
Glands	Solid Neoprene
Cover Arms	Reinforced Thermoplastic Polyester
Arm Springs	Stainless Steel (17-7 type)
Covers	Reinforced Thermoplastic Polyester
Cover Screw	Nickel-plated brass
Rotating Sealing Disc	Polycarbonate
Gaskets	Solid Neoprene
Contact Carrier	High-Impact Thermoset
Retainer	High-Impact Thermoset
Phase, Ground Sleeves	Brass
Sleeve Spring	20A and 30A Stainless Steel (300 Series); others are Beryllium Copper multi-contact inserts with silver plating
Terminal Screws	Stainless Steel (300 Series)
Assembly Screws	Stainless Steel (300 Series)
Plug	
Housing	Zytel® ST801 Nylon
Locking Ring	Reinforced Thermoplastic Polyester
Sealing Gasket	Solid Neoprene
Cord Clamp	Reinforced Thermoplastic Polyester
Gland Cap	Reinforced Thermoplastic Polyester
Gland	Solid Neoprene
Cord Clamp Screws	Stainless Steel (300 Series)
Clamp Nut	Nickel-Plated Brass
Gland Clamp Screws	Stainless Steel (300 Series)
Contact Carrier	High-Impact Thermoset
Retainer	High-Impact Thermoset
Ground, Phase Pins	Brass (M-Series - Nickel-plated brass)
Terminal Screws	Stainless Steel (300 Series)
Assembly Screws	Stainless Steel (300 Series)
Receptacle	
Housing	Zytel® 101 Nylon
Mounting Flange	Zytel® 101 Nylon
Arm Spring	Stainless Steel (17-7 type)
Cover Arm	Reinforced Thermoplastic Polyester
Cover	Reinforced Thermoplastic Polyester
Cover Screw	Nickel-plated brass
Rotating Sealing Disc	Polycarbonate
Gaskets	Solid Neoprene
Mounting Screws	Stainless Steel (300 Series)
Terminal Screws	Stainless Steel (300 Series)
Phase, Ground Sleeves	Brass
Sleeve Spring	20A and 30A Stainless Steel (300 Series); others are Beryllium Copper multi-contact inserts with silver plating

Listed to standard UL1682/CSA C22.2 No. 182.1-02, Plugs, Receptacles and cable connectors of the Pin and Sleeve Type.

UL Classified to IEC Standards 60309-1 (Plugs, Socket Outlets, and Couplers for Industrial Purposes) for Series I (European) rated voltages and services.

When used with cord, these devices require no further investigation by UL for equipment Classification to IEC 435 or IEC 380.

Specifications

Typical Specification

Manufacturer's Identification	Hubbell HBL520P9W
Description	Plug, Power Supply
Type	3 Pole + Neutral + Earth
Rating	20A, 120/208V AC, 3 Phase WYE
Configuration	UL 1686 C2, IEC 60309-2, Clock Position 9, Watertight
Certification	UL Listed, File E146032 Receptacles and Inlets, E146033 Plugs and Connectors, UL Standard UL1682 and UL 1686C2, CSA Certified File LR280C for Plugs, Connectors Inlets and LR285C for Receptacle CSA Standard C22.2 No. 182.1, UL Classified to IEC 60309-1 IEC 60309-2

© Zytel is registered trademark of E.I. DuPont.

Valox® is a trademark of SABIC Innovative Plastics, acquired from General Electric Company.



Performance

Electrical

Dielectric Withstand Voltage	3000V AC.
Max. Working Voltage	600V RMS (i.e., minimum creepage distance 10 millimeters, minimum clearance 8 millimeters, per IEC 60309-1 for devices rated over 500V).
Current Interrupting	Certified for current interrupting at full rated current (Except DC rated devices).
Temperature Rise	Max. 30°C temperature rise at full rated current after 50 cycles of overload at 150% of rated current at a power factor of 75%.
Endurance	5,000 connect and disconnect cycles with load for 16A and 20A, 1,000 cycles with load and 1,000 cycles without load for 30A, 32A, 60A and 63A, and 250 cycles with load and 250 cycles without load for 100A and 125A.

Mechanical

Impact Resistance	Per CSA C22.2 No. 182.1 / UL1682.
Cord Grip Cable Retention	Per CSA C22.2 No. 182.1 / UL1682.
Cord Accommodation	Round portable service cords of diameters commensurate with the device rating as defined in UL Standard 62, CSA C22.2 No. 49 and the harmonized <HAR> European Standards.
Terminal Identification	Terminals identified in accordance with North American and IEC conventions.
Product Identification	Identification and ratings are a permanent part of the device housing.

Environmental

Moisture Resistance	Watertight per IEC 60309-1.
Ingress Protection	IP67 Suitability.
Flammability	HB or better per UL 94 or CSA C22.2 No. 0.17.
Operating Temperatures	Maximum Continuous 75°C; Minimum - 40°C without impact.

Materials

Housings	Nylon.
All Other Materials	Resistant to corrosion and chemical attack.

Note: Specification sheets for all other Pin and Sleeve catalog numbers are available upon request.

Horsepower Ratings for Hubbell IEC Pin and Sleeve Devices*

Single Phase

Amps	Wire Count	Voltage	Clock	Catalog Number	New HP Rating
20	3	125V	4	HBL320x4W	1
20	3	250V	6	HBL320x6W	2
20	3	480V	7	HBL320x7W	5
20	4	125/250 (208L-L)	12	HBL420x12W	2
20	4	125/250 (250L-L)	12	HBL420x12W	2
20	4	125/250 (125L-N)	12	HBL420x12W	1
30	3	125V	4	HBL330x4W	2
30	3	250V	6	HBL330x6W	3
30	3	480V	7	HBL330x7W	7.5
30	3	550VDC	8	HBL330X8	N/A
30	4	125/250 (208L-L)	12	HBL430x12W	3
30	4	125/250 (250L-L)	12	HBL430x12W	3
30	4	125/250 (125L-N)	12	HBL430x12W	2
60	3	125V	4	HBL360x4W	2
60	3	250V	6	HBL360x6W	3
60	3	480V	7	HBL360x7W	7.5
60	3	250VDC	3	HBL360x3W	N/A
60	3	550VDC	8	HBL360x8W	N/A
60	4	125/250 (208L-L)	12	HBL460x12W	3
60	4	125/250 (250L-L)	12	HBL460x12W	3
60	4	125/250 (125L-N)	12	HBL460x12W	2
100	3	125V	4	HBL3100x4W	5
100	3	250V	6	HBL3100x6W	15
100	3	480V	7	HBL3100x7W	30
100	3	250VDC	3	HBL3100x3W	N/A
100	3	550VDC	8	HBL3100x8W	N/A
100	4	125/250 (208L-L)	12	HBL4100x12W	10
100	4	125/250 (250L-L)	12	HBL4100x12W	15
100	4	125/250 (125L-N)	12	HBL4100x12W	5

3-Phase

Amps	Wire Count	Voltage	Clock	Catalog Number	Present HP Rating	New HP Rating
20	4	3Ø 250V	9	HBL420x9W	2	5
20	4	3Ø 480V	7	HBL420x7W	5	10
20	4	3Ø 600V	5	HBL420x5W	7.5	10
20	4	3Ø 380-415V	6	HBL420x6W	-	7.5
20	5	3ØY 120/208V	9	HBL520x9W	0.5	3
20	5	3ØY 277/480V	7	HBL520x7W	5	10
20	5	3ØY 347/600V	5	HBL520x5W	7.5	10
20	5	3Ø 240/415V	6	HBL520x6W	-	5
30	4	3Ø 250V	9	HBL430x9W	3	7.5
30	4	3Ø 480V	7	HBL430x7W	7.5	15
30	4	3Ø 600V	5	HBL430x5W	10	20
30	5	3ØY 120/208V	9	HBL530x9W	2	5
30	5	3ØY 277/480V	7	HBL530x7W	7.5	15
30	5	3ØY 347/600V	5	HBL530x5W	10	20
30	4	3Ø 380/415V	6	HBL430x6W	-	10
30	5	3Ø 200/346-240/415	6	HBL530x6W	-	10
60	4	3Ø 250V	9	HBL460x9W	5	7.5
60	4	3Ø 480V	7	HBL460x7W	10	20
60	4	3Ø 600V	5	HBL460x5W	15	25
60	4	3Ø 380-415VAC	6	HBL460x6W	-	10
60	5	3ØY 120/208V	9	HBL560x9W	3	7.5
60	5	3ØY 277/480V	7	HBL560x7W	10	20
60	5	3ØY 347/600V	5	HBL560x5W	15	25
60	5	3Ø 200/346-240/415	6	HBL560x6W	-	10
100	4	3Ø 250V	9	HBL4100x9W	10	15
100	4	3Ø 480V	7	HBL4100x7W	30	40
100	4	3Ø 600V	5	HBL4100x5W	30	50
100	4	3Ø 380-415V	6	HBL4100x6W	-	30
100	5	3ØY 200/346-240/415V	6	HBL5100x6W	-	30
100	5	400VDC	8	HBL5100x8W	-	N/A
100	5	3ØY 120/208V	9	HBL5100x9W	10	15
100	5	3ØY 277/480V	7	HBL5100x7W	30	40
100	5	3ØY 347/600V	5	HBL5100x5W	30	50

Note: *Horsepower Ratings are NOT standardized amongst different Pin and Sleeve manufacturers.



Features and Benefits

IP67
SUITABILITY

Unfused Circuit-Lock® Pin and Sleeve Mechanical Interlocks

The National Electrical Code (NEC®) requires a separate disconnect means within sight of all motor loads. The NEC requires the disconnecting means in a motor-circuit be listed as “Suitable as Motor Disconnect” if the motor is rated greater than 2 HP.

Hubbell’s revolutionary Circuit-Lock interlock incorporates the disconnect switch and receptacle in one compact, non-metallic and economical unit. Removing the plug and locking it out provides a visual means of verifying equipment has been disconnected. All Circuit-Lock mechanical interlocks can be locked out as a method of compliance with the OSHA Lockout/Tagout regulation.

The switch cannot be turned ON until the plug is completely engaged, and the plug cannot be removed until the switch is turned OFF. At the same time, it eliminates the possibility of making or breaking the circuit under load or making a casual or “lazy” connection. The non-metallic enclosure can be connected to the metallic conduit and not interfere with the ground continuity.

In addition, these horsepower rated units are durable, watertight and easy to install. And they are compatible with IEC 60309-2 plugs. These Circuit-Lock units are available in 20, 30, 60 and 100A models, and in 3, 4 and 5 wire configurations that are designed to the IEC 60309-1 and 60309-2 standards.

Hubbell’s Circuit-Lock Mechanical Interlocks are also available in “Reverse Service” versions. These units incorporate the disconnect switch and reverse service receptacle (inlet) in one compact, non-metallic and economical unit. These units are available in 30, 60 and 100A models, 4 wire configurations.



HBL430MI7W



Housing Design

- Insulated non-metallic housing, super tough, non-conductive and chemical resistant for heavy duty industrial environments
- IEC pin and sleeve devices are color coded by voltage for easy identification
- Self-closing gasketed cover, detents into position to fully close automatically



Interior Design

- Large gears enclosed in a gear box assembled on one plane to eliminate possible gear jumping
- Horsepower rated disconnect switch handles large motor loads
- DIN rail mounted switch for easy installation and replacement



Safety

- Lockable handle to meet OSHA Lockout/Tagout regulations
- Two-stage interlocking mechanism to help defeat tampering
- Watertight conduit hub and grounding plate for use on metallic conduit (IP67 suitability)
- Captured neoprene gasket for a watertight seal



Liftcover

- Replaceable spring-loaded liftcover with gasket for a watertight seal
- Pre-wired IEC Pin and Sleeve receptacle
- Reverse service has dependable solid brass pins for longer life and reliable electrical contact



Identification

- Color coded rating pad and receptacle mount to signify voltage



Installation

- Comes with brass inserts and stainless steel screws for higher torque and better sealing
- Three molded-in conduit drill points are located on top, bottom and back surface of enclosure
- Adjustable mounting feet are ductile to allow mounting on irregular surfaces

NEC® is a registered trademark of the National Fire Protection Association (NFPA).

Pin and Sleeve Devices/Mechanical Interlocks



IP67
SUITABILITY

Enclosure Type 4X, 12

Rating				Unfused Circuit-Lock® Devices				Reverse Service	
Amps	Poles and Wires	Configuration Recep.	Plug	AC Voltage	Mechanical Interlock	Mating Plug	Mechanical Interlock	Mating Plug	
20	3P 4W			120/240V			—	—	
	3P 4W			3Ø 240V			—	—	
	3P 4W			3Ø 480V			—	—	
	3P 4W			3Ø 600V			—	—	
30	2P 3W			120V			—	—	
	2P 3W			240V			—	—	
	2P 3W			480V			—	—	
	3P 4W			120/240V			—	—	
	3P 4W			3Ø 240V			HBL430MI9WR	HBL430P9WR	
	3P 4W			3Ø 480V			HBL430MI7WR	HBL430P7WR	
	3P 4W			3Ø 600V			HBL430MI5WR	HBL430P5WR	
	4P 5W			3ØY 120/208V			—	—	
	4P 5W			3ØY 277/480V			—	—	
	4P 5W			3ØY 347/600V			—	—	
32	3P 4W			380V 50HZ-440V 60Hz			—	—	
60	2P 3W			120V			—	—	
	2P 3W			240V			—	—	
	2P 3W			480V			—	—	
	3P 4W			120/240V			HBL460MI12WR	HBL460P12WR	
	3P 4W			3Ø 240V			HBL460MI9WR	HBL460P9WR	
	3P 4W			3Ø 480V			HBL460MI7WR	HBL460P7WR	
	3P 4W			3Ø 600V			HBL460MI5WR	HBL460P5WR	
	4P 5W			3ØY 120/208V			—	—	
	4P 5W			3ØY 277/480V			—	—	
	4P 5W			3ØY 347/600V			—	—	
100	2P 3W			240V			—	—	
	3P 4W			120/240V			HBL4100MI12WR	HBL4100P12WR	
	3P 4W			3Ø 240V			HBL4100MI9WR	HBL4100P9WR	
	3P 4W			3Ø 480V			HBL4100MI7WR	HBL4100P7WR	
	3P 4W			3Ø 600V			HBL4100MI5WR	HBL4100P5WR	
	4P 5W			3ØY 120/208V			—	—	

Note: 20, 30 and 32A – 1 inch NPT hub supplied; 60 and 100A – 1/4 inch hub supplied.



HBLAC1



HBLAC2



HBL30RGB

HBL30RNB



MICPK30



CA3430MI



HBL30MIRS



HBLRFT2

Dimensions in Inches (mm)

Auxiliary Contacts for 20, 30, 32, 60 and 100A Switch, NEMA A600 Pilot Duty

Description	Catalog Number
"Break After Main Break", 1 set of n/o contacts, 1 set of n/c contacts.	HBLAC1
"Break Before Main Break", 1 set of n/o contacts.	HBLAC2

Ground Block

Description	Catalog Number
For 20, 30 and 32A switches.	HBL30RGB
For 60 and 100A switches.	HBL60100RGB

Neutral Block

Description	Catalog Number
For 20, 30 and 32A switches.	HBL30RNB
For 60A switches.	HBL60RNB
For 100A switches.	HBL100RNB

Watertight Closure Plug Kits

Description	Catalog Number
For 20, 30 and 32A Circuit-Lock Unfused and Fused Pin and Sleeve mechanical interlocks.	MICPK30
For 60 and 100A Circuit-Lock Unfused and Fused Pin and Sleeve mechanical interlocks.	MICPK60

Replacement Flip Covers

Description	Catalog Number
For 20A mechanical interlocks.	CA420MI
For 30 and 32A, 3 and 4 wire mechanical interlocks.	CA3430MI
For 30A, 5 wire mechanical interlocks.	CA530MI
For 60A mechanical interlocks.	CA60MI
For 100A mechanical interlocks.	CA100MI

Replacement Switches

Description	Catalog Number
For 20A mechanical interlocks.	HBLDS3RS
For 30 and 32A mechanical interlocks.	HBL30MIRS
For 60 and 100A mechanical interlocks.	HBLDS60100RS

Replacement Mounting Feet

Description	Catalog Number
For 20, 30, 32, 60 and 100A mechanical interlocks.	HBLRFT2*

Dimensions

KEY	20A and 30A Inches (mm)	60A Inches (mm)	100A Inches (mm)
A	7.75" (196.9)	7.75" (196.9)	7.75" (196.9)
B	6.87" (174.5)	6.87" (174.5)	6.87" (174.5)
C	4.75" (120.7)	4.75" (120.7)	4.75" (120.7)
D	1.02" (25.9)	1.02" (25.9)	1.02" (25.9)
E	1.60" (40.6)	1.46" (37.1)	1.46" (37.1)
F	11.00" (279.4)	12.75" (323.9)	12.75" (323.9)
G	8.75" (222.3)	8.75" (222.3)	8.75" (222.3)
H	8.00" (203.2)	9.75" (247.7)	9.75" (247.7)
I	10.12" (257.0)	11.87" (301.5)	11.87" (301.5)
J	6.88" (174.8)	6.88" (174.8)	6.88" (174.8)
K	1.93" (49.0)	2.09" (53.1)	2.09" (53.1)
L	11.25" (285.8)**	13.65" (346.7)	13.65" (346.7)
M	7.75" (196.9)	8.60" (218.4)	9.30" (236.2)
HUB SIZE	1.00" NPT	1.25" NPT	1.25" NPT

Note: *Package of 10 feet and 10 screws.

**30 and 32A, 3 and 4W = 11.50" (292.1);

30A, 5W = 11.59" (294.4).

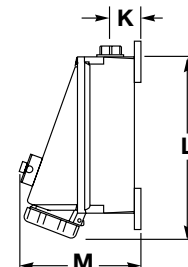
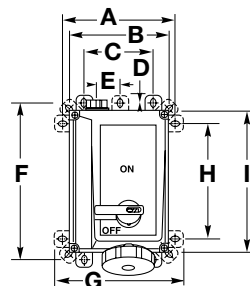
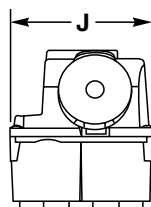



Typical Specifications

Manufacturer's Identification	Hubbell HBL430MI7W
Description	Circuit-Lock® Pin and Sleeve Mechanical Interlock
Electrical Type	3 Pole + Earth
Rating	30A, 480V AC, 3 Phase
Configuration	IEC 60309-2, UL1686 C2, Clock position 7
Enclosure Type	Outdoor - 4X (Watertight, Washdown); Indoor - 12 (Dust-tight, Falling Dirt and Noncorrosive Liquids)
Ingress Protection	IP67 Suitability
Enclosure Material	Non-metallic, enclosure suitable for metallic conduit
Certification	UL Listed, CSA Certified

Note: This device provides on/off switched control of a plug connected load and includes an interlocking feature to prevent the plug from being disconnected while the receptacle is energized. The switch cannot be turned "ON" until the plug is inserted properly, and the plug cannot be removed until the switch is turned "OFF."

Materials

Part	Material	Part	Material
Base	Valox®	Top	Valox®
Handle	Valox®	Conduit Hub	Zinc
Enclosure Gasket	Neoprene	Shaft	Valox®
Shaft Seal	Neoprene	Ground Plate	Galvanized Steel
Enclosure Screws	Stainless Steel 300 Series	Enclosure Inserts	Brass
Hinge Pins	Nickel Plated Brass	Hinge Spring	Stainless Steel 300 Series

Performance

Electrical	
Dielectric Voltage	Withstands 3,000V AC Min.
Max. Working Voltage	600V AC RMS.
Current Interrupting	Certified for current interrupting at full rated current and voltage.
Short Circuit Withstand Rating	Suitable for use on a circuit capable of delivering not more than 10,000 RMS symmetrical amperes at the voltage rating of the receptacle. 20A and 30A models: Suitable for use on a circuit capable of delivering not more than 65,000 RMS symmetrical amperes, 600V when protected by class "J" fuses rated 30A.
Operations	Mechanical 10,000 cycles, electrical 6,000 cycles.

Mechanical	
Impact Resistance	In accordance with UL 746C.
Terminal Identification	In accordance with UL, CSA and international conventions.
Product Identification	Identification and ratings are part of the external label and molded into the receptacle mount.
Mounting	External adjustable feet.

Environmental	
Moisture Resistance	Outdoor - 4X (Watertight, Washdown); Indoor - 12 (Dust-tight, Falling Dirt and Noncorrosive Liquids).
Ingress Protection	IP67 Suitability.
Flammability	UL94-5VA and V-0 Classification.
Operating Temperature	Max. Continuous +75°C; Min. Continuous -40°C.
UV Resistance	All materials are UV stabilized.

Horsepower Ratings

Amps	AC Voltage Rating	Horsepower	Mechanical Interlock	Mating Plug
20	120/240V AC	2	HBL420MI12W	HBL420P12W
20	3Ø 240V AC	5	HBL420MI9W	HBL420P9W
20	3Ø 480V AC	10	HBL420MI7W	HBL420P7W
20	3Ø 600V AC	10	HBL420MI5W	HBL420P5W
30	120V AC	2	HBL330MI4W	HBL330P4W
30	240V AC	3 (208-240V AC)	HBL330MI6W	HBL330P6W
30	480V AC	7.5	HBL330MI7W	HBL330P7W
30	120/240V AC	3 (208-240V AC)	HBL430MI12W	HBL430P12W
30	3Ø 600V AC	20	HBL430MI5W	HBL430P5W
30	3Ø 480V AC	15	HBL430MI7W	HBL430P7W
30	3Ø 250V AC	7.5	HBL430MI9W	HBL430P9W
30	3ØY 347/600V AC	20	HBL530MI5W	HBL530P5W
30	3ØY 277/480V AC	15	HBL530MI7W	HBL530P7W
30	3ØY 120/208V AC	5	HBL530MI9W	HBL530P9W
32	380V AC 50Hz – 440V AC 60Hz	15 (440V AC 3Ø 60Hz)	HBL432MI3W	HBL432P3W
60	120V AC	3	HBL360MI4W	HBL360P4W
60	240V AC	7.5 (208-240V AC)	HBL360MI6W	HBL360P6W
60	480V AC	20	HBL360MI7W	HBL360P7W
60	120/240V AC	7.5 (208-240V AC)	HBL460MI12W	HBL460P12W
60	3Ø 600V AC	40	HBL460MI5W	HBL460P5W
60	3Ø 480V AC	30	HBL460MI7W	HBL460P7W
60	3Ø 250V AC	15	HBL460MI9W	HBL460P9W
60	3ØY 347/600V AC	40	HBL560MI5W	HBL560P5W
60	3ØY 277/480V AC	30	HBL560MI7W	HBL560P7W
60	3ØY 120/208V AC	15	HBL560MI9W	HBL560P9W
100	240V AC	15 (10 @ 208V AC)	HBL3100MI6W	HBL3100P6W
100	120/240V AC	15	HBL4100MI12W	HBL4100P12W
100	3Ø 600V AC	50	HBL4100MI5W	HBL4100P5W
100	3Ø 480V AC	50	HBL4100MI7W	HBL4100P7W
100	3Ø 250V AC	25 (208-240V AC)	HBL4100MI9W	HBL4100P9W
100	3ØY 120/208V AC	20	HBL5100MI9W	HBL5100P9W

Valox® is a trademark of SABIC Innovative Plastics, acquired from General Electric Company.



Features and Benefits

IP66
SUITABILITY

Fused Circuit-Lock® Pin and Sleeve Mechanical Interlocks

Hubbell Circuit-Lock® Pin and Sleeve Mechanical Interlocks are a revolutionary design that incorporates a disconnect switch and pin and sleeve receptacle in a compact non-metallic unit. These devices offer maximum safety by preventing users from mating or breaking a circuit under load—Hubbell's interlock mechanism detects the presence of a plug and prevents it from being removed when the switch is in the "ON" position.

It features a high visibility red handle that can be locked to meet OSHA lockout/tagout regulations, and the enclosure door can be locked to prevent unauthorized access. The rugged, corrosion-resistant Type 4X Valox® enclosure features adjustable mounting feet for flexible installation, while the receptacle's spring-loaded cover with gasket is dust tight and provides a watertight seal when turned and locked.

The patented Plug-Check™ mechanism detects the presence of the plug. It operates as a clutch to engage the handle with the switch and captures the plug. This action prevents the plug from being removed until the switch is turned OFF.

- Mechanically interlocked to prevent mating and breaking under load
- Available in both IEC and UL1686-C1 Insulgrip® styles
- IEC reverse service units available for safely connecting generators

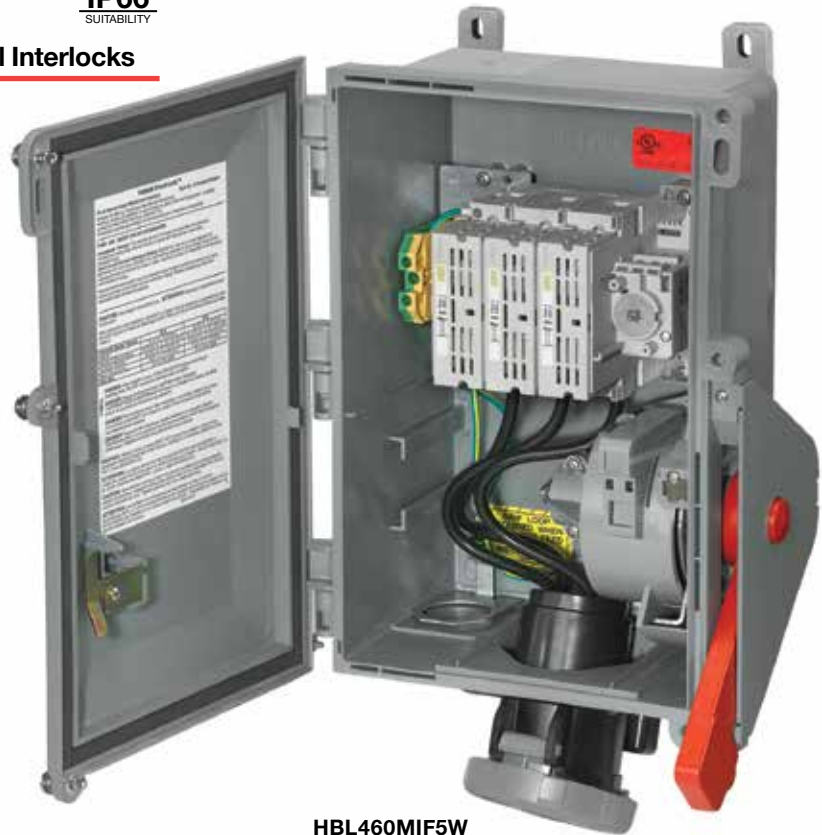

HBL460MIF5W



Housing Design

- Non-metallic enclosure meets UL 50E Type 4X (watertight), 12 (dust-tight) and IP66 suitability requirements. Enclosure is molded of rugged thermoplastic PBT to resist abuse, corrosion and enhance safety
- Stainless steel ¼ turn door fasteners for quick, easy access to fuses



Interior Design

- Compact Fused Disconnect Switch accepts **Class "J" fuses**. Fuse holders are top mounted for easy access
- The switch accepts auxiliary contacts for control circuit applications including the ON/OFF control of remote pilot lights or signal for programmable controllers



Safety

- High visibility red handle can be locked in the OFF position as a method of compliance with OSHA lockout requirements. Accepts up to a 5/16 inch padlock shackle
- Replaceable spring-loaded receptacle liftcover with gasket ensures dust tight rating; liftcover provides watertight seal when turned and locked



Contact Carrier

- Thermoset polyester contact carrier provides resistance to electrical tracking and withstands higher temperatures
- Thermoset properties provide excellent dimensional stability, low moisture absorption and superior dielectric strength



Enclosure Door

- Removable door for ease of wiring and installation
- Enclosure door can be locked to prevent unauthorized access. Additionally, if the switch is ON, the door cannot be opened



Installation

- Three molded-in conduit drill points are located on the top, bottom and back surface of enclosure. Conduit hub provided: 30A 1 in. NPT, 60A 1¼ in. NPT
- Conduit hub and adjustable mounting feet (4) are ductile to allow mounting on irregular surfaces

IP66
SUITABILITY

Enclosure Type 4X, 12

Rating					Fused Circuit-Lock® Devices		
Amps	Poles and Wires	Configuration Recept./ Conn.	Plug/ Inlet	AC Voltage	Mechanical Interlock	Mating Plug	
30	3P 4W			120/240V		HBL430MIF12W	HBL430P12W
	3P 4W			3Ø 240V		HBL430MIF9W	HBL430P9W
	3P 4W			3Ø 480V		HBL430MIF7W	HBL430P7W
	3P 4W			3Ø 600V		HBL430MIF5W	HBL430P5W
	4P 5W			3ØY 277/480V		HBL530MIF7W	HBL530P7W
	4P 5W			3ØY 347/600V		HBL530MIF5W	HBL530P5W
60	3P 4W			120/240V		HBL460MIF12W	HBL460P12W
	3P 4W			3Ø 240V		HBL460MIF9W	HBL460P9W
	3P 4W			3Ø 480V		HBL460MIF7W	HBL460P7W
	3P 4W			3Ø 600V		HBL460MIF5W	HBL460P5W
	4P 5W			3ØY 120/208V		HBL560MIF9W	HBL560P9W

Note: 30A – 1 inch NPT hub supplied; 60A – 1¼ inch hub supplied.



HBL430MIF12W

Gray Style Switch



HBLACFSNO **HBL30MIFRS**

Black Style Switch



ACFSNO **30MIFRS**

Replacement Auxiliary Contacts

Description	Black Style Switch Catalog Number	Gray Style Switch Catalog Number
Auxiliary contact, normally open, A600 pilot duty, break before break.	ACFSNO	HBLACFSNO
Auxiliary contact, normally closed, A600 pilot duty, break before break.	ACFSNC	HBLACFSNC

Note: Auxiliary contacts are specific to the style switch noted and are NOT interchangeable. All new installations are shipped with gray style switch.

Replacement Switches

Description	Black Style Switch Catalog Number	Gray Style Switch Catalog Number
For 30A fused switches.	30MIFRS	HBL30MIFRS
For 60A fused switches. Gray Style switch will retro fit Black Style switch.	—	HBL60MIFRS

Note: If replacing a Black Style switch, you must use the **30MIFRS**. All other applications can use the Gray Style switch.



MICPK30

Watertight Closure Plug Kits

Description	Catalog Number
For 30A Circuit-Lock® unfused and fused Pin and Sleeve mechanical interlocks.	MICPK30
For 60 and 100A Circuit-Lock® unfused and fused Pin and Sleeve mechanical interlocks.	MICPK60



CA3430MI

Replacement Flip Covers

Description	Catalog Number
For 30A, 3 and 4 wire mechanical interlocks.	CA3430MI
For 30A, 5 wire mechanical interlocks.	CA530MI
For 60A mechanical interlocks.	CA60MI



HBLRFT2

Replacement Mounting Feet

Description	Catalog Number
Replacement mounting feet and screws for 30 and 60A fused mechanical interlocks.	HBLRFT2^A

Note: ^APackage of 10 feet and 10 screws.



Specifications

Typical Specifications

Manufacturer's Identification	Hubbell HBL460MIF7W
Description	Fused Circuit-Lock Pin and Sleeve Mechanical Interlock
Electrical Type	3 Pole + Earth
Rating	60A, 480V AC, 3 Phase
Configuration	IEC 60309-2, UL1686C2, Clock Position 7
Enclosure Type	Outdoor - 4X (Watertight, Washdown) Indoor - 12 (Dust-tight, Falling dirt)
Certification	UL Listed for US and Canada

Materials

Part	Material
Base and Top	PBT
Handle	PBT
Conduit Hub	Zinc, 30A-1", 60A-1¼" NPT
Enclosure Gasket	Neoprene
Shaft	Brass
Shaft Seal	Neoprene
Ground Plate	Galvanized Steel
Enclosure Screws	Stainless Steel
Mounting Inserts	Brass
Hinge Pin	Nickel-Plated Brass
Hinge Spring	Stainless Steel

Note: This device provides fused switched control of a plug connected load and includes an interlocking feature to prevent the plug from being disconnected or the fuse door opened while the receptacle is energized. The switch cannot be turned on until the plug is inserted properly.

Performance

Electrical	
Dielectric Voltage	Withstands 3,000V AC Min.
Max. Working Voltage	600V AC.
Current Interrupting	Certified for current interrupting at full rated current and voltage.
Short Circuit Withstand Rating	Suitable for use on a circuit capable of delivering not more than 200,000 RMS symmetrical amperes at the voltage rating of receptacle.
Operations	
	Mechanical 10,000 cycles minimum.

Mechanical	
Impact Resistance	In accordance with UL 746C.
Terminal Identification	In accordance with UL, CSA and international conventions.
Product Ratings	Ratings are part of the external label and molded into the receptacle mount and color-coded.
Mounting	External adjustment feet.

Environmental	
Moisture Resistance	Outdoor - 4X (Watertight, Washdown); Indoor - 12 (Dust-tight, Falling dirt).
Ingress Protection	IP66 Suitability.
Flammability	UL94-5VA and V-0 Classification.
Operating Temperatures	Max. Continuous +75°C; Min. Continuous -40°C.
UV Resistance	All materials are UV stabilized.
Fuse Types	UL Listed Class "J". CSA Certified HRCI-J.

Horsepower Ratings

Amps	AC Voltage Rating	Standard	Maximum**	Mechanical Interlock	Use Pin and Sleeve Plug
30	3Ø 600V AC	7.5	20	HBL430MIF5W	HBL430P5W
30	3Ø 480V AC	5	15	HBL430MIF7W	HBL430P7W
30	3Ø 240V	3	7.5	HBL430MIF9W	HBL430P9W
30	120/240V AC	1.5*	3*	HBL430MIF12W	HBL430P12W
30	3ØY 277/480V	5	15	HBL530MIF7W	HBL530P7W
30	3ØY 347/600V	7.5	20	HBL530MIF5W	HBL530P5W
60	3Ø 600V AC	15	50	HBL460MIF5W	HBL460P5W
60	3Ø 480V AC	15	30	HBL460MIF7W	HBL460P7W
60	3Ø 240V AC	7.5	15	HBL460MIF9W	HBL460P9W
60	120/240V AC	3*	10*	HBL460MIF12W	HBL460P12W
60	3ØY 120/208V	7.5	15	HBL560MIF9W	HBL560P9W

Note: *208-240V AC L-L.

**Requires time delay fuses.

Dimensions

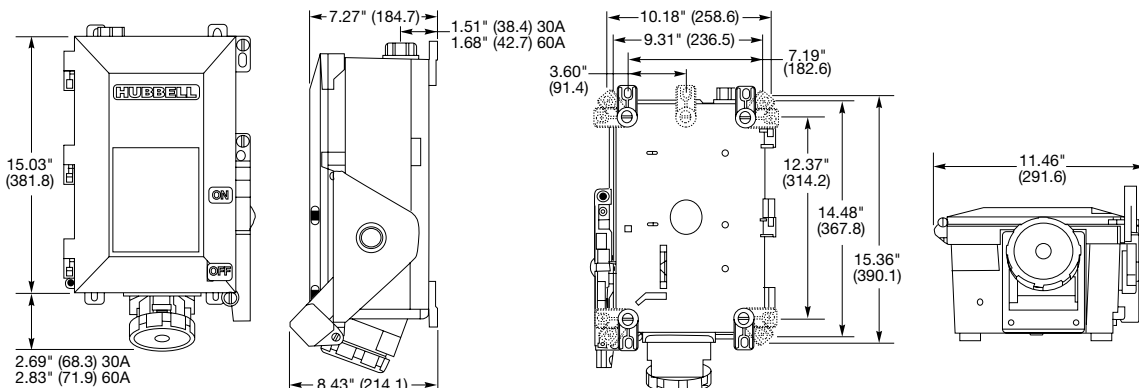

Dimensions in Inches (mm)

Features and Benefits

20 and 30 Amps Low Profile

Hubbell Wiring Device-Kellems Low Profile Compact Design, these devices are often used in indoor locations and maintenance, food service areas where aesthetics and space are concerns, assembly areas, stamping operations, warehouse and maintenance areas.

Applications: Agriculture, Chemical Processing, Construction, Entertainment, Food Service, Light Manufacturing, Military.



L430P9



L430R9



Housing Design

- Nylon construction, both interior and exterior are made of tough, durable nylon
- Shrouded, recessed pins are protected from impact and abuse



Cord Grip

- Integrated cord grip limits strain on terminals, keeps cord connected



Safety

- Large markings for easy recognition results in ease of wiring on the assembly line or in the field



Brass Box Terminal

- Permits high clamping pressure on conductors without damaging wire strands for best electrical conductivity
- Solid one-piece pins construction, for long life, reliable electrical contact and maximum conductivity



Identification

- Color coding for quick, easy visual identification of mating devices
- Ratings and certification are molded into the nylon housing for easy identification and reordering



Split Sleeves

- Self-adjusting stainless steel springs assure constant contact pressure (20A and 30A). On 60A devices, Beryllium copper insert with multiple contact points assures easy insertion and a tight fit
- Stainless steel terminal screws resist rust and corrosion

Low Profile Devices

Rating						Devices		Cord Diameter	
Amps	Poles and Wires	Configuration Recep./ Plug/ Conn. Inlet	AC Voltage	Plug	Receptacle	Min. Inches (mm)	Max. Inches (mm)		
20	3P 4W		3Ø 250V				.350" - .710" (8.3 - 15.9)		
30	3P 4W		125/250V				.390" - .775" (9.9 - 19.7)		
30	3P 4W		3Ø 250V				.390" - .775" (9.9 - 19.7)		
60	3P 4W		3Ø 250V				.75" - 1.25" (19.1 - 31.8)		
				With Cover: A460R9KIT					
60	4P 5W		3ØY 120/208V				.89" - 1.42" (22.6 - 36.1)		
100	4P 5W		3ØY 120/208V				1.34" - 1.50" (34.0 - 38.1)		

Specifications

Electrical

Dielectric Withstand Voltage	3000V AC
Max. Working Voltage	250V RMS
Current Interrupting Temperature Rise	Certified for current interruption at full rated current. Max. 30°C temperature rise at full rated current after 50 cycles of overload at 150% of rated current at a power factor of 75%.

Endurance	Up to 5,000 connect and disconnect cycles at full rated current and voltage.
-----------	--

Mechanical

Impact Resistance	Per CSA C22.2 No. 182.1 / UL1682
Cord Grip Cable Retention	Per CSA C22.2 No. 182.1 / UL1682
Cord Accommodation	Round portable service cords of diameters commensurate with the device rating as defined in UL standard 62, CSA C22.2 No. 49 and the <HAR> European Standards.
Terminal Identification	Terminals identified in accordance with North American convention.
Product Identification	Ratings are a permanent part of the device housing.

Environmental

Flammability	HB or better per UL94 or CSA C22.2 No. 0.17
Ingress Protection	IP22 Suitability
Operating Temperatures	Maximum Continuous 75° C; Minimum -40°C without impact

Application Guide

Agriculture	Indoor location and maintenance.
Chemical Processing	Indoor location and maintenance.
Construction	Indoors for added safety and abuse resistance.
Entertainment	Indoor location and maintenance.
Food Service	Food service areas where aesthetics and space are concerns.
Light Manufacturing	Indoor locations and maintenance.
Manufacturing	Light assembly areas, stamping operations and maintenance areas.
Military	Warehouse and maintenance areas.

Materials

Plug	Material
Case	Zytel® 101 Nylon
Shroud	Zytel® 101 Nylon
Pin Carrier 20 & 30A	Zytel® 101 Nylon
Pin and Carrier 60A	High-Impact Thermoset
Pins	Brass CDA#360
Assembly Screws	Stainless Steel (300 series)
Terminal Screws	Stainless Steel (300 series)

Receptacle

Body	Zytel® 101 Nylon
Sleeve Carrier 20 & 30A	Zytel® 101 Nylon
Sleeve Carrier 60A	High-Impact Thermoset
Sleeves	Brass CDA #360
Assembly Screws	Stainless Steel (300 series)
Terminal Screws	Stainless Steel (300 series)
Adapter Plate 20 & 30A	Galvanized Steel
Adapter Plate 60A	Aluminum
Wall Trim Plate	Zytel® 101 Nylon
Panel Mount Trim Plate	Stainless Steel (300 series)

Note: See page G-29 for product dimensions.



Plug Dimensions

Type	A	B	C	D	Cord Range Diameter
L430P12	2.97" (75.4)	4.18" (106.2)	3.50" (88.9)	1.71" (43.4)	.390"-.775" (9.9-19.7)
A460P9	3.38" (85.9)	4.25" (108.0)	7.00" (177.8)	–	.75"-1.25" (19.1- 31.8)
A5100P9	4.92" (125.00)	5.07" (128.81)	8.60" (218.35)	–	1.34"-1.50" (34.0- 38.1)

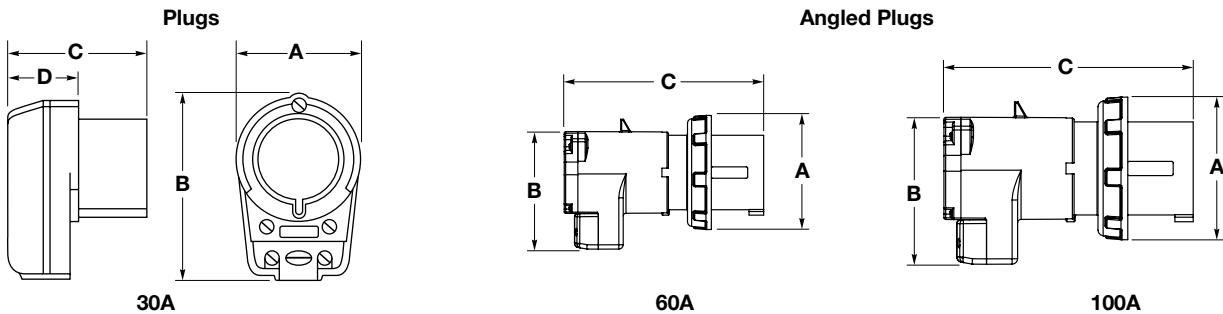

Wall Mount Receptacle Dimensions

Type	A	B	C	D	E	F
L420R9	2.60" (66.0)	2.81" (71.4)	2.28" (57.9)	2.38" (60.5)	–	–
L430R12	3.12" (79.2)	3.12" (79.2)	2.77" (70.4)	2.76" (70.1)	–	–
A460R9	4.50" (114.3)	4.50" (114.3)	4.48" (113.8)	–	3.62" (91.9)	.50" (12.7)

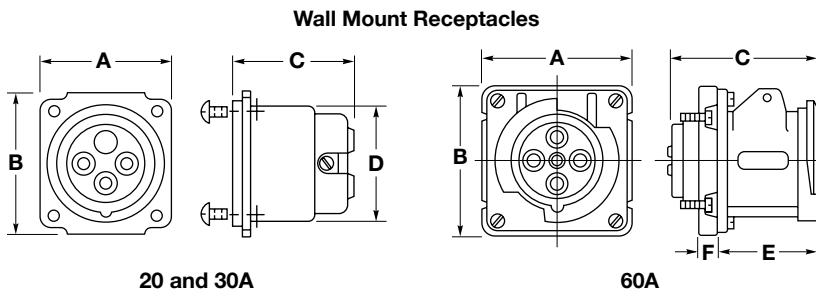

Adapter Plate (Included with "L" and "A" series receptacles)

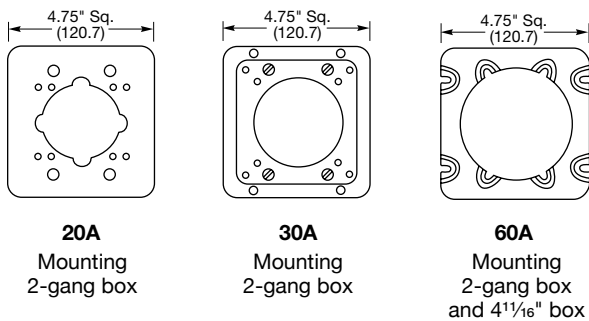

Panel Cutout

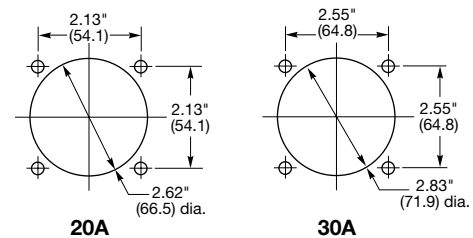

Dimensions in Inches (mm)



IEC Pin and Sleeve Terminal Identification – Rear View

Description	Rating		Terminal Marking Pattern*			
	Domestic	International	Receptacle and Connector		Plug and Inlet	
			Domestic	International	Domestic	International
3 Wire	125V AC 277V AC	100-130V				
3 Wire	250V AC 480V AC 600V AC	200-250V 380-415V AC				
4 Wire	125/250V AC 1ØY 120/208V	—				
4 Wire	(3Ø Δ) 250V AC 480V AC 600V AC	380-415V AC				
5 Wire	(3ØY) 120/208V AC 277/480V AC 347/600V AC	220/380V 50Hz 250/440V 60Hz 200/346V to 240/415V 50 and 60Hz				

Note: *Location of grounding contact position will change as clock positions assigned to specific voltages change.
 ★Pilot contacts supplied on 4 and 5 wire, 63 and 125 Amp international rated devices.



Ground Path

To reduce the likelihood of electrical shock, the National Electrical Code requires that non-current carrying metallic components be grounded. Insulgrip Pin and Sleeve wiring devices offer two styles of grounding.

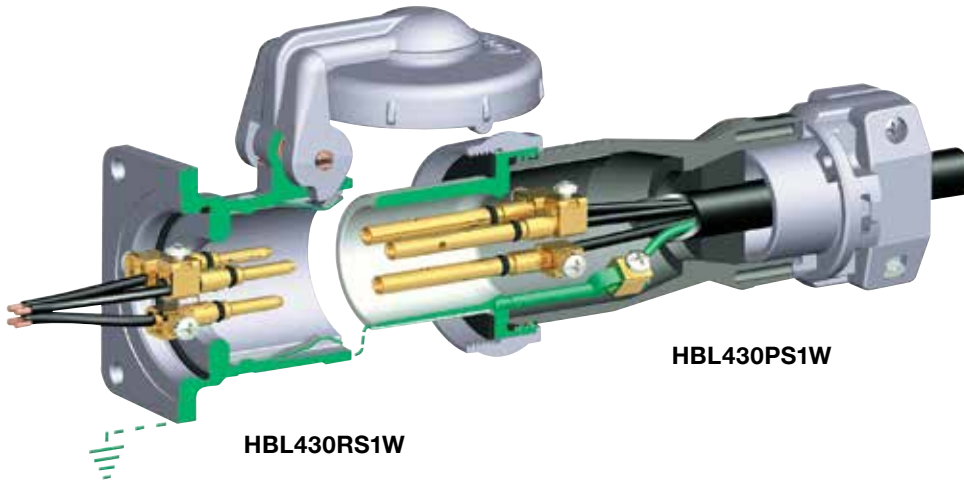

Style I

Receptacles achieve grounding by attaching the ground conductor to the ground screw inside the back box and utilizing the metallic receptacle shell as a ground source (see 3P 4W Style I illustration). Plugs and connectors establish grounding by means of connecting the flexible cable ground conductor to a ground terminal within each device, which, in turn, is grounded through the metallic plug or connector shroud. Any exposed metallic components are suitably grounded in the Style I offering.

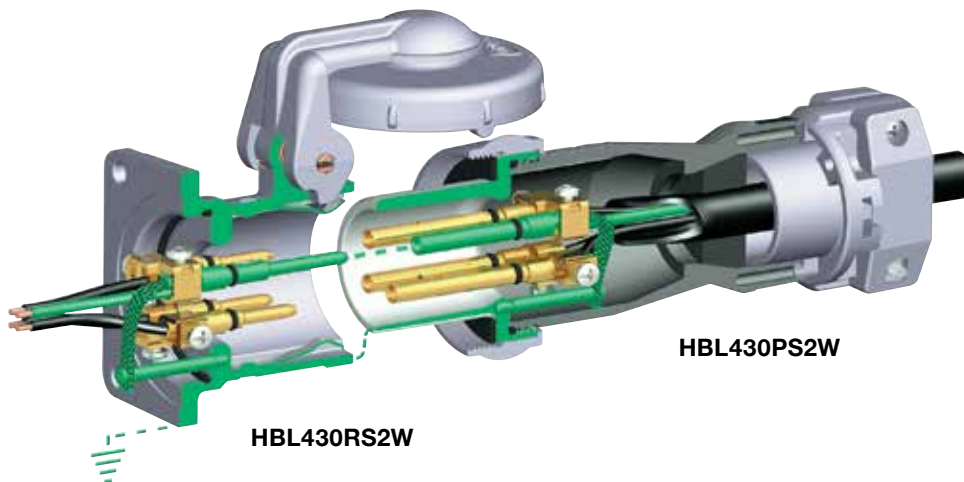

Style II

The Style II ground path offers two means of achieving the proper ground path. In addition to utilizing the same grounding method as in the Style I product, the Style II version incorporates a separate ground pin and sleeve (see 3P 4W Style II illustration). This provides a second ground path. The ground pin on Style II devices is longer than other pins, meaning that they "make first" and "break last," assuring protection for people and equipment.

New Pole and Wire Terminology

Style I			Style II		
New	Old	No. of Contacts	New	Old	No. of Contacts
2P 3W	2W 2P	2	2P 3W	2W 3P	3
3P 4W	3W 3P	3	3P 4W	3W 4P	4
4P 5W	4W 4P	4			

Features and Benefits

UL 1686 C1 Insulgrip® Pin and Sleeve Devices

With the introduction of UL standard 1686-C1, configurations are uniform throughout the industry. That means Hubbell—the name that sets the standard for pin and sleeve performance, reliability, durability, innovation and ease of use—can finally become your standard. Hubbell's new line of heavy duty Insulgrip® Pin and Sleeve wiring devices not only offers complete interchangeability, it delivers the goods when it comes to superior design and construction. Hubbell Insulgrip Pin and Sleeve devices are engineered and built to handle today's most demanding work environments, making Hubbell the unsurpassed heavyweight in the heavy duty market.

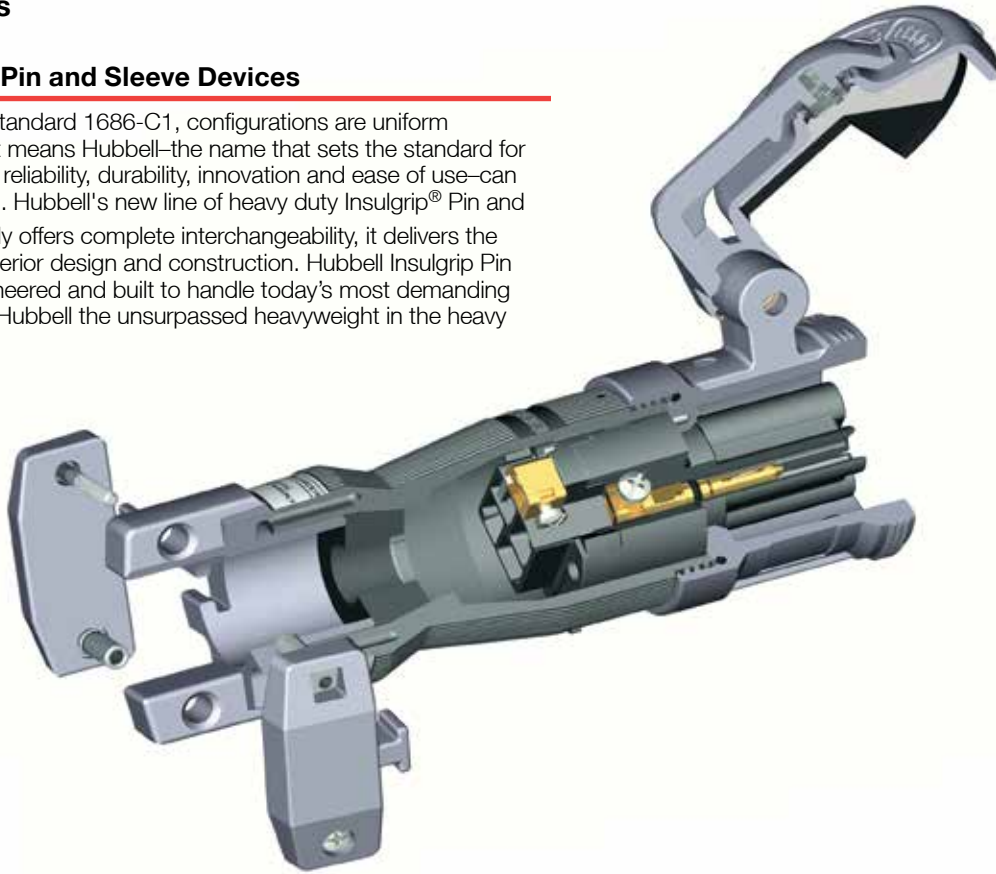

Housing Design

- Thermoplastic housing provides excellent insulating, impact, corrosion, and UV resistant properties. Protects users and internal components in the roughest of environments
- Spring-loaded, gasketed cover provides a UL Type 4X watertight, dust-tight seal on connectors and receptacles

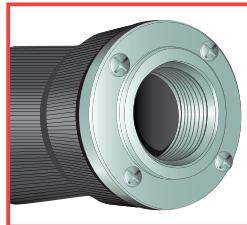

Liquidtight Conduit Adapters

- Machined aluminum adapters are available to provide a means for attaching flexible liquidtight metal conduit to rear of Hubbell Pin and Sleeve plug or connector



Powerful Mechanical Cord Grip

- Hubbell's design incorporates two molded-in teeth to securely grip the outer cable jacket, and internal conductors to prevent slippage and strain on terminations
- Captive barrel nuts ease assembly and allow higher tightening torque for maximum cord retention



Terminal Entrance Holes

- Large, square funneled entrance holes isolate each conductor to protect against shorts due to stray conductor strands
- Tapered hole provides a fast and easy guide into the termination chamber
- Pin chamber confines arcing within the interior chamber during make and break cycle of mating devices, minimizes arc tracking

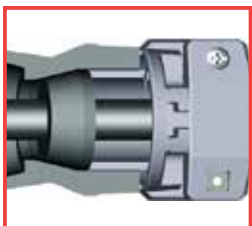

Watertight Cord Entrance

- The tapered bore entrance creates high compression forces on sealing gland, providing a watertight seal around cord
- Individual solid neoprene glands are supplied to match a full range of cord sizes and assure watertight performance



Anti-Vibration Box Terminals

- Interlocking box terminals ensure that terminal screws remain secure and cannot loosen
- The floating box is designed to obtain high-torque values without damaging stranded conductors

Features and Benefits

UL 1686 C1 Insulgrip® Pin and Sleeve Devices

Metallic where you want it, non-metallic where you need it. Different from traditional all-metallic devices, Hubbell Pin and Sleeve wiring devices are designed to provide metallic shrouding where you want it and a non-metallic housing where you need it.

What's more, Hubbell's new watertight Insulgrip Pin and Sleeve wiring devices are designed with safety first and foremost. We created the line with plant facility maintenance personnel and a safer industrial work environment in mind. To greatly reduce the likelihood of electrical shock, we developed our exclusive nonmetallic watertight system, meaning that with Hubbell on the job, the mix of electricity and water isn't the threat it once was. So, whether the job calls for a welding outlet in a dry location or a motor disconnect in a wet location, step up to Hubbell Pin and Sleeve wiring devices.

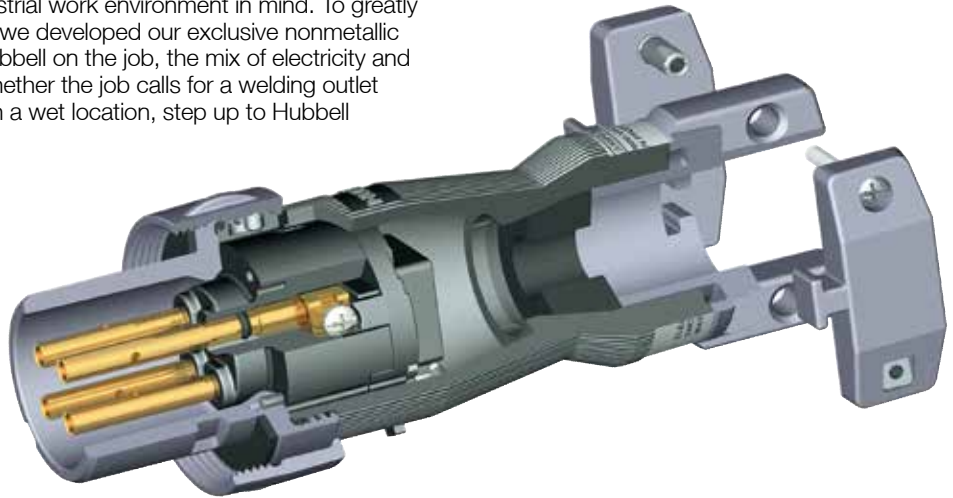

Housing Design

- Thermoplastic housing provides excellent insulating, impact, corrosion, and UV resistant properties. Protects users and internal components in the roughest of environments
- Locking ring provides a UL Type 4X watertight and dust-tight seal when the male and female devices are connected

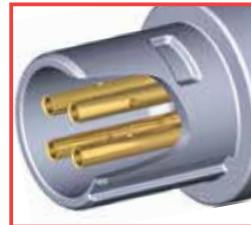

Shrouded Sleeves

- Housing seal provides a watertight and dust-tight seal when mated with receptacle or connector
- Protects the user from the possibility of touching live contacts during insertion and withdrawal of mating parts
- Shrouded sleeves protects contact sleeves from deforming from physical abuse



Interior Design

- Sleeve O-ring seal provides a watertight and dust-tight seal around the sleeves. Assures that contamination will not enter wire chamber
- All-brass sleeve contacts provide reliable electrical contact with mating pins, also with minimum heat build-up over time



Thermoset Polyester Contact Carrier

- Molded thermoset polyester provides high resistance to electrical tracking
- Withstands higher temperatures which may result from overload or arcing
- Thermoset properties provide dimensional stability for this critical assembly







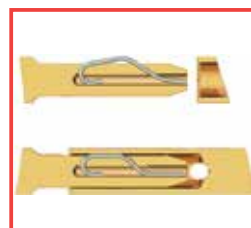



















Product Marking







- Catalog number and rating visible while in use. Markings are color coded differentiating Style I and Style II devices



Beryllium Copper Spring-Pin Design (Patented)

- Maintains high unit pressure on mating sleeves. Ensures reliable electrical contact while minimizing heat rise due to normal pin wear over time

Rating				Style I Devices			Replacement Interiors	
Amps	Poles and Wires	Receptacle/Connector Configuration*	Maximum Voltage AC/DC					
30	2P 3W		600/250	HBL330RS1W	HBL330PS1W	HBL330CS1W	IN330FS1	IN330MS1
	3P 4W		600/250	HBL430RS1W	HBL430PS1W	HBL430CS1W	IN430FS1	IN430MS1
	4P 5W		600/250	HBL530RS1W	HBL530PS1W	HBL530CS1W	IN530FS1	IN530MS1
60	2P 3W		600/250	HBL360RS1W	HBL360PS1W	HBL360CS1W	IN360FS1	IN360MS1
	3P 4W		600/250	HBL460RS1W	HBL460PS1W	HBL460CS1W	IN460FS1	IN460MS1
	4P 5W		600/250	HBL560RS1W	HBL560PS1W	HBL560CS1W	IN560FS1	IN560MS1
100	2P 3W		600/250	HBL3100RS1W	HBL3100PS1W	HBL3100CS1W	IN3100FS1	IN3100MS1
	3P 4W		600/250	HBL4100RS1W	HBL4100PS1W	HBL4100CS1W	IN4100FS1	IN4100MS1
	4P 5W		600/250	HBL5100RS1W	HBL5100PS1W	HBL5100CS1W	IN5100FS1	IN5100MS1
200	3P 4W		600/250	HBL4200RS1W	HBL4200PS1W	HBL4200CS1W	IN4200FS1†	IN4200MS1†
	4P 5W		600/250	HBL5200RS1W	HBL5200PS1W	HBL5200CS1W	IN5200FS1†	IN5200MS1†
Rating				Style II Devices			Replacement Interiors	
Amps	Poles and Wires	Receptacle/Connector Configuration*	Maximum Voltage AC/DC	Receptacle	Plug	Connector	Connector & Receptacle	Plug
30	2P 3W		600/250	HBL330RS2W	HBL330PS2W	HBL330CS2W	IN330FS2	IN330MS2
	3P 4W		600/250	HBL430RS2W	HBL430PS2W	HBL430CS2W	IN430FS2	IN430MS2
60	2P 3W		600/250	HBL360RS2W	HBL360PS2W	HBL360CS2W	IN360FS2	IN360MS2
	3P 4W		600/250	HBL460RS2W	HBL460PS2W	HBL460CS2W	IN460FS2	IN460MS2
100	2P 3W		600/250	HBL3100RS2W	HBL3100PS2W	HBL3100CS2W	IN3100FS2	IN3100MS2
	3P 4W		600/250	HBL4100RS2W	HBL4100PS2W	HBL4100CS2W	IN4100FS2	IN4100MS2
200	2P 3W		600/250	HBL3200RS2W	HBL3200PS2W	HBL3200CS2W	IN3200FS2†	IN3200MS2†
	3P 4W		600/250	HBL4200RS2W	HBL4200PS2W	HBL4200CS2W	IN4200FS2†	IN4200MS2†

Rating				Corrosion Resistant Devices			Accessories	
Amps	Poles and Wires	Receptacle/Connector Configuration*	Maximum Voltage AC/DC					
200	4P 5W		600/250	M5200RS1	M5200PS1	M5200CS1	MB2003W MB2004W	AA20045

Note: **CAUTION:** To avoid electrical shock, review premises carefully and DO NOT use if Pin and Sleeve configuration (design) is already in a circuit having a rating differing from the rating of this device.

**While in use or with cover closed.

























†Consult factory.





Corrosion resistant cord sets are available on page Y-17 of this catalog.

Pin and Sleeve Devices/Mechanical Interlocks



TYPE 4X**

Rating				"Reversed Service" Style I Devices			Replacement Interiors	
Amps	Poles and Wires	Receptacle/ Connector Configuration*	Maximum Voltage AC/DC					
				Receptacle	Plug	Connector	Connector & Receptacle	Plug
30	2P 3W		600/250	HBL330RS1WR	HBL330PS1WR	HBL330CS1WR	IN330MS1	IN330FS1
	3P 4W		600/250	HBL430RS1WR	HBL430PS1WR	HBL430CS1WR	IN430MS1	IN430FS1
	4P 5W		600/250	HBL530RS1WR	HBL530PS1WR	HBL530CS1WR	IN530MS1	IN530FS1
60	2P 3W		600/250	HBL360RS1WR	HBL360PS1WR	HBL360CS1WR	IN360MS1	IN360FS1
	3P 4W		600/250	HBL460RS1WR	HBL460PS1WR	HBL460CS1WR	IN460MS1	IN460FS1
	4P 5W		600/250	HBL560RS1WR	HBL560PS1WR	HBL560CS1WR	IN560MS1	IN560FS1
100	2P 3W		600/250	HBL3100RS1WR	HBL3100PS1WR	HBL3100CS1WR	IN3100MS1	IN3100FS1
	3P 4W		600/250	HBL4100RS1WR	HBL4100PS1WR	HBL4100CS1WR	IN4100MS1	IN4100FS1
	4P 5W		600/250	HBL5100RS1WR	HBL5100PS1WR	HBL5100CS1WR	IN5100MS1	IN5100FS1
200	3P 4W		600/250	HBL4200RS1WR	HBL4200PS1WR	HBL4200CS1WR	IN4200MS1†	IN4200FS1†
	4P 5W		600/250	HBL5200RS1WR	HBL5200PS1WR	HBL5200CS1WR	IN5200MS1†	IN5200FS1†
Rating				"Reversed Service" Style II Devices			Replacement Interiors	
Amps	Poles and Wires	Receptacle/ Connector Configuration*	Maximum Voltage AC/DC	Receptacle	Plug	Connector	Connector & Receptacle	Plug
30	2P 3W		600/250	HBL330RS2WR	HBL330PS2WR	HBL330CS2WR	IN330MS2	IN330FS2
	3P 4W		600/250	HBL430RS2WR	HBL430PS2WR	HBL430CS2WR	IN430MS2	IN430FS2
60	2P 3W		600/250	HBL360RS2WR	HBL360PS2WR	HBL360CS2WR	IN360MS2	IN360FS2
	3P 4W		600/250	HBL460RS2WR	HBL460PS2WR	HBL460CS2WR	IN460MS2	IN460FS2
100	2P 3W		600/250	HBL3100RS2WR	HBL3100PS2WR	HBL3100CS2WR	IN3100MS2	IN3100FS2
	3P 4W		600/250	HBL4100RS2WR	HBL4100PS2WR	HBL4100CS2WR	IN4100MS2	IN4100FS2
200	2P 3W		600/250	HBL3200RS2WR	HBL3200PS2WR	HBL3200CS2WR	IN3200MS2†	IN3200FS2†
	3P 4W		600/250	HBL4200RS2WR	HBL4200PS2WR	HBL4200CS2WR	IN4200MS2†	IN4200FS2†

Rating				"Reversed Service" Corrosion Resistant Devices			Accessories	
Amps	Poles and Wires	Receptacle/ Connector Configuration*	Maximum Voltage AC/DC			Connector		
				Receptacle	Plug	Connector	Back Boxes	Angle Adapter
200	4P 5W		600/250	M5200BS1R	M5200CS1R	—	MB2003W MB2004W	AA20045

Note: ***CAUTION:** To avoid electrical shock, review premises carefully and DO NOT use if Pin and Sleeve configuration (design) is already in a circuit having a rating differing from the rating of this device.

**While in use or with cover closed.

†Consult factory.

Corrosion resistant cord sets are available on page Y-17 of this catalog.



MB30



MB304W

MB601003W



MB601006W



MB2003W



CC3430

ILR1



SAB34

074093403

Insulgrip Pin and Sleeve Metallic Back Boxes

Hubbell manufactures an extensive line of back boxes for use with UL 1686 Pin and Sleeve devices. Each back box is designed to give the user the maximum amount of wiring room while achieving grounding to metallic conduit.

Metallic 30° Angle Back Box*

Description	Amps	NPT Hub Size	Catalog Number
Back box for 30A devices.	30	3/4"	MB301W
	30	1"	MB302W

Metallic 15° Angle Back Box*

Description	Amps	NPT Hub Size	Catalog Number
Back box for 60A devices.	60	1"	MB601W
	60	1 1/4"	MB602W
	60	1 1/2"	MB603W

Metallic Feed-Thru Back Box*

Description	Amps	NPT Hub Size	Catalog Number
Straight feed-thru box for 30A devices.	30	3/4"	MB303W
	30	1"	MB304W
Straight feed-thru box for 60A devices.	60	1"	MB604W
	60	1 1/4"	MB605W
	60	1 1/2"	MB606W

Metallic Four-Way Angle Back Box*

Description	Amps	NPT Hub Size	Catalog Number
Four-way 15° angle box for 60 and 100A devices.	60/100	1 1/4"	MB601002W
	60/100	1 1/2"	MB601003W
	60/100	2"	MB601004W
Four-way 45° angle box for 200A devices.	200	2"	MB2003W
	200	2 1/2"	MB2004W
45° Angle adapter only for 200A devices.	200	-	AA20045

Metallic Four-Way Feed-Thru 15° Angle Back Box*

Description	Amps	NPT Hub Size	Catalog Number
Four-way feed-thru, 15° angle for 60 and 100A devices.	60/100	1 1/4"	MB601006W
	60/100	1 1/2"	MB601007W
	60/100	2"	MB601008W

Note: *These boxes are cast aluminum, suitable for IP54 requirements and are finished with enamel paint.

Replacement Cord Clamp and Locking Ring

Description	Used on	Cord Clamp Catalog Number	Locking Ring Catalog Number
Fits all 30A plugs and connectors.	All 3, 4, 5 wire	CC3430	ILR1**
Fits all 60A plugs and connectors.	4 wire (Style 2) and all 5 wire	CC60	ILR2**
	All 3 wire and 4 wire (Style 1)	CC60	ILR3**
Fits all 100A plugs and connectors.	4 wire (Style 2) and all 5 wire	CC100	ILR4**
	All 3 wire and 4 wire (Style 1)	CC100	ILR5**
Fits all 200A plugs and connectors.	All 3, 4, 5 wire	CC201	-

Note: **Locking Ring only.

Liquidtight Adapters

Rating of Hubbell Pin and Sleeve Device	Liquidtight Conduit Size	Hubbell Liquidtight Adapter	Optional Kellems Liquidtight Conduit Grip
30 Amp	1/2" NPT	SAB12	074093402
	3/4" NPT	SAB34	074093403
	1" NPT	SAB100	074093404
60 Amp	1" NPT	SAC100	074093404
	1 1/4" NPT	SAC125	074093405
100 Amp	1 1/4" NPT	SAD125	074093405
	1 1/2" NPT	SAD150	074093406



Plug Dimensions

Amps	Type	A		B		Cord Grip Range
		Style I	Style II	Style I	Style II	
30	330P	7.53" (191)	7.53" (191)	3.00" (76)	3.00" (76)	.375-1.20" (9.5-30.5)
	430P	7.53" (191)	7.53" (191)	3.00" (76)	3.00" (76)	.375-1.20" (9.5-30.5)
	530P	7.53" (191)		3.00" (76)		.375-1.20" (9.5-30.5)
60	360P	9.40" (239)	9.40" (239)	3.40" (86)	3.40" (86)	.500-1.45" (12.7-36.8)
	460P	9.40" (239)	9.40" (239)	3.40" (86)	3.70" (94)	.500-1.45" (12.7-36.8)
	560P	9.40" (239)		3.70" (94)		.500-1.45" (12.7-36.8)
100	3100P	10.70" (272)	10.70" (272)	3.70" (94)	3.70" (94)	.925-1.94" (27.0-49.3)
	4100P	10.70" (272)	10.90" (277)	3.70" (94)	4.00" (102)	.925-1.94" (27.0-49.3)
	5100P	10.90" (277)		4.00" (102)		.925-1.94" (27.0-49.3)
200	3200P		11.13" (282)		6.35" (161)	1.00-2.50" (25.4-63.5)
	4200P	11.13" (282)	11.13" (282)	6.35" (161)	6.70" (170)	1.00-2.50" (25.4-63.5)
	5200P	11.13" (282)		6.70" (170)		1.00-2.50" (25.4-63.5)

Connector Body Dimensions

Amps	Type	A		B		Cord Grip Range
		Style I	Style II	Style I	Style II	
30	330C	8.38" (213)	8.38" (213)	3.74" (95)	3.74" (95)	.375-1.20" (9.5-30.5)
	430C	8.38" (213)	8.38" (213)	3.74" (95)	3.74" (95)	.375-1.20" (9.5-30.5)
	530C	8.38" (213)		3.74" (95)		.375-1.20" (9.5-30.5)
60	360C	9.90" (251)	9.90" (251)	3.50" (89)	3.50" (89)	.500-1.45" (12.7-36.8)
	460C	9.90" (251)	10.10" (256)	3.50" (89)	3.80" (96)	.500-1.45" (12.7-36.8)
	560C	10.10" (256)		3.80" (96)		.500-1.45" (12.7-36.8)
100	3100C	11.70" (297)	11.70" (297)	4.50" (114)	4.50" (114)	.925-1.94" (27.0-49.3)
	4100C	11.70" (297)	11.90" (302)	4.50" (114)	4.70" (119)	.925-1.94" (27.0-49.3)
	5100C	11.90" (302)		4.70" (119)		.925-1.94" (27.0-49.3)
200	3200C		13.65" (346)		7.00" (177)	1.00-2.50" (25.4-63.5)
	4200C	13.65" (346)	13.65" (346)	7.00" (177)	7.39" (187)	1.00-2.50" (25.4-63.5)
	5200C	13.65" (346)		7.39" (187)		1.00-2.50" (25.4-63.5)

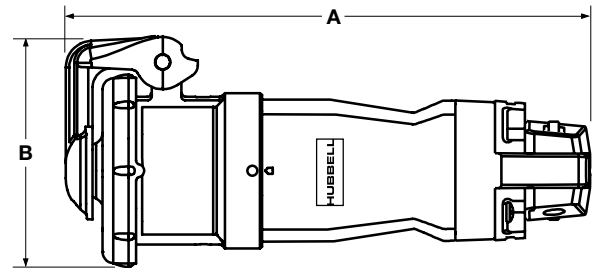
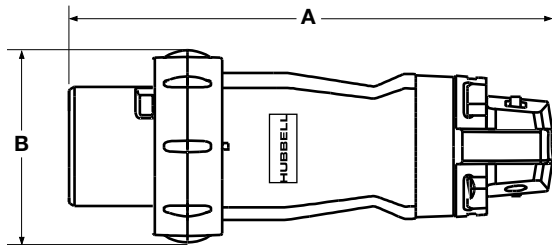

Receptacle Dimensions

Amps	Type	A		B		C		D		E	
		Style I	Style II	Style I	Style II	Style I	Style II	Style I	Style II	Style I	Style II
30	330R	2.72" (69)	2.72" (69)	3.40" (86)	3.40" (86)	3.89" (99)	3.89" (99)	3.19" (81)	3.19" (81)	1.37" (35)	1.37" (35)
	430R	2.72" (69)	2.72" (69)	3.40" (86)	3.40" (86)	3.89" (99)	3.89" (99)	3.19" (81)	3.19" (81)	1.37" (35)	1.37" (35)
	530R	2.72" (69)		3.40" (86)		3.89" (99)		3.19" (81)		1.37" (35)	
60	360R	3.50" (89)	3.50" (89)	4.25" (108)	4.25" (108)	4.66" (118)	4.66" (118)	4.42" (112)	4.42" (112)	1.54" (39)	1.54" (39)
	460R	3.50" (89)	3.50" (89)	4.25" (108)	4.25" (108)	4.66" (118)	4.66" (118)	4.42" (112)	4.42" (112)	1.54" (39)	1.54" (39)
	560R	3.50" (89)		4.25" (108)		4.66" (118)		4.42" (112)		1.54" (39)	
100	3100R	3.50" (89)	3.50" (89)	4.25" (108)	4.25" (108)	4.66" (118)	4.70" (119)	5.30" (135)	5.30" (135)	1.54" (39)	1.54" (39)
	4100R	3.50" (89)	3.50" (89)	4.25" (108)	4.25" (108)	4.66" (118)	4.70" (119)	5.30" (135)	5.30" (135)	1.54" (39)	1.54" (39)
	5100R	3.50" (89)		4.25" (108)		4.66" (118)		5.30" (135)		1.54" (39)	
200	3200R		6.50" (165)		7.00" (177)		5.63" (143)		7.76" (197)		.99" (25)
	4200R	6.50" (165)	6.90" (170)	7.00" (177)	7.39" (187)	5.63" (143)	5.63" (143)	7.76" (197)	7.76" (197)	.99" (25)	.99" (25)
	5200R	6.90" (170)		7.39" (187)		5.63" (143)		7.76" (197)		.99" (25)	

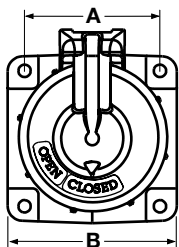

30, 60 and 100 Amp

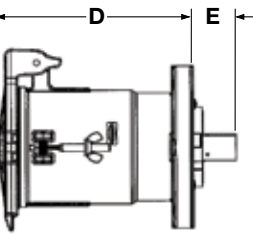
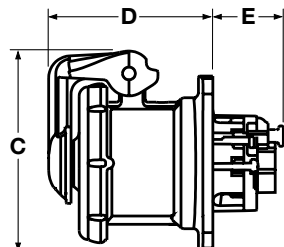

200 Amp

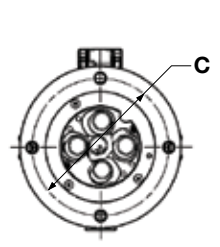

Dimensions in Inches (mm)

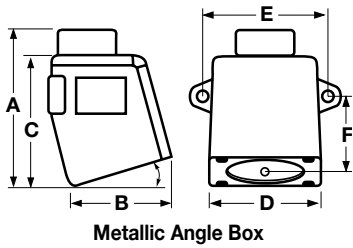

Metallic Angle Box

Metallic Angle Back Box

Description	NPT Hub Size	A Inch (mm)	B Inch (mm)	C Inch (mm)	D Inch (mm)	E Inch (mm)	F Inch (mm)	Catalog Number
30° Angle back box for 30A devices.	¾"	4.87" (124.0)	2.94" (75.0)	4.02" (102.0)	3.40" (86.0)	4.25" (108.0)	2.12" (54.0)	MB301W
	1"	4.87" (124.0)	2.94" (75.0)	4.02" (102.0)	3.40" (86.0)	4.25" (108.0)	2.12" (54.0)	MB302W
15° Angle back box for 60A devices.	1"	-	4.80" (121.9)	-	-	5.25" (133.4)	2.69" (68.3)	MB601W
	1¼"	-	4.80" (121.9)	-	-	5.25" (133.4)	2.69" (68.3)	MB602W
	1½"	-	4.80" (121.9)	-	-	5.25" (133.4)	2.69" (68.3)	MB603W

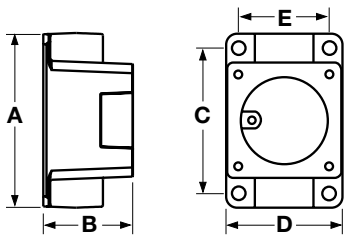

Metallic Feed-Thru Box

Metallic Feed-Thru Back Box

Description	NPT Hub Size	A Inch (mm)	B Inch (mm)	C Inch (mm)	D Inch (mm)	E Inch (mm)	F Inch (mm)	Catalog Number
Back box for 30A devices.	¾"	5.35" (136.0)	2.91" (74.0)	4.53" (115.0)	3.59" (91.0)	2.62" (67.0)	-	MB303W
	1"	5.35" (136.0)	2.91" (74.0)	4.53" (115.0)	3.59" (91.0)	2.62" (67.0)	-	MB304W
Back box for 60A devices.	1"	6.50" (165.1)	3.80" (97.0)	5.75" (146.1)	4.50" (114.3)	3.50" (88.9)	-	MB604W
	1¼"	6.50" (165.1)	3.80" (97.0)	5.75" (146.1)	4.50" (114.3)	3.50" (88.9)	-	MB605W
	1½"	6.50" (165.1)	3.80" (97.0)	5.75" (146.1)	4.50" (114.3)	3.50" (88.9)	-	MB606W

Metallic Four-Way Angle Back Box

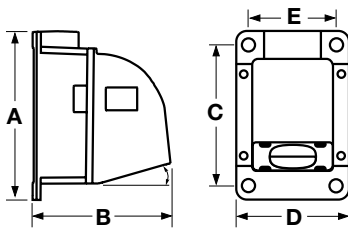

Metallic Four-Way Angle Box

Description	NPT Hub Size	A Inch (mm)	B Inch (mm)	C Inch (mm)	D Inch (mm)	E Inch (mm)	F Inch (mm)	Catalog Number
15° Angle four-way box for 60 and 100A devices.	1¼"	7.92" (201.0)	8.52" (216.0)	7.00" (178.0)	6.14" (156.0)	4.88" (124.0)	-	MB601002W
	1½"	7.92" (201.0)	8.52" (216.0)	7.00" (178.0)	6.14" (156.0)	4.88" (124.0)	-	MB601003W
	2"	7.92" (201.0)	8.52" (216.0)	7.00" (178.0)	6.14" (156.0)	4.88" (124.0)	-	MB601004W
45° Angle four-way box for 200A devices.	2"	10.82" (274.8)	9.86" (250.4)	9.50" (241.3)	8.17" (207.5)	6.75" (171.5)	-	MB2003W
	2½"	10.82" (274.8)	9.86" (250.4)	9.50" (241.3)	8.17" (207.5)	6.75" (171.5)	-	MB2004W
45° Angle adapter only for 200A devices.	-	8.00" (203.2)	6.00" (152.4)	7.00" (178.0)	8.00" (203.2)	7.00" (178.0)	-	AA20045

Metallic Four-Way Feed-Thru 15° Angle Back Box

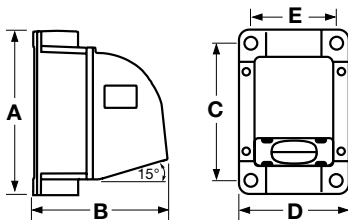

Metallic Feed-Thru Angle Box

Description	NPT Hub Size	A Inch (mm)	B Inch (mm)	C Inch (mm)	D Inch (mm)	E Inch (mm)	F Inch (mm)	Catalog Number
Four-way Feed-thru box for 60 and 100A devices.	1¼"	7.98" (202.7)	8.55" (217.2)	7.00" (178.0)	6.14" (156.0)	4.88" (124.0)	-	MB601006W
	1½"	7.98" (202.7)	8.55" (217.2)	7.00" (178.0)	6.14" (156.0)	4.88" (124.0)	-	MB601007W
	2"	7.98" (202.7)	8.55" (217.2)	7.00" (178.0)	6.14" (156.0)	4.88" (124.0)	-	MB601008W

Note: These boxes are cast aluminum, suitable for IP54 requirements and are finished with enamel paint.

Dimensions in Inches (mm)



Materials (30, 60, 100, and 200 Amp)

Plug	Material
Housing	Valox® 357 (200A Aluminum)
Plug Shroud	Aluminum
Cord Clamps	Rynite® SST35 (200A Aluminum)
Clamp Nut	Nickel Plated Brass
Gland Cap	Rynite® SST35
Gland	Neoprene
O-Rings, Gaskets & Seals	Neoprene
Contact Carrier	Thermoset Polyester
Retainer	Thermoset Polyester
Sleeves	Brass (M-Series - Nickel-plated tellurium copper)
Box Terminal	Heat Treated & Zinc Plated Steel
Screws (Terminal, Assembly & Set)	Stainless Steel (300 Series)
Ground Standoff	Brass
Ground Bracket	Nickel Plated Spring Bronze
Locking Ring	Epoxy Painted Aluminum
Connector Body	
Housing	Valox® 357 (200 Amp Aluminum)
Connector Shroud	Epoxy Painted Aluminum
Cord Clamps	Rynite® SST35
Clamp Nut	Nickel Plated Brass
Gland Cap	Rynite® SST35 (200A Aluminum)
Gland	Neoprene
O-Rings, Gaskets & Seals	Neoprene
Contact Carrier	Thermoset Polyester
Retainer	Thermoset Polyester
Pin	Brass (M-Series - Nickel-plated tellurium copper)
Pin Spring	Beryllium Copper
Box Terminal	Heat Treated & Zinc Plated Steel
Screws (Terminal, Assembly & Set)	Stainless Steel (300 Series)
Ground Standoff	Brass
Ground Bracket	Nickel Plated Spring Bronze
Cover	Epoxy Painted Aluminum
Cover Arm	Epoxy Painted Aluminum
Spring Guide	Stainless Steel (300 Series)
Springs (Arm & Wave)	Stainless Steel (300 Series)
Spring Washer	Stainless Steel (300 Series)
Hinge Bushing	Aluminum
Rivet	Aluminum
Receptacle	
Housing/Flange	Epoxy Painted Aluminum
O-Rings, Gaskets & Seals	Neoprene
Contact Carrier	Thermoset Polyester
Retainer	Thermoset Polyester
Pin	Brass (M-Series - Nickel-plated tellurium copper)
Pin Spring	Beryllium Copper
Box Terminal	Heat Treated & Zinc Plated Steel
Screws (Terminal, Assembly & Set)	Stainless Steel (300 Series)
Ground Standoff	Brass
Ground Bracket	Steel
Cover	Epoxy Painted Aluminum
Cover Arm	Epoxy Painted Aluminum
Spring Guide	Stainless Steel (300 Series)
Springs (Arm & Wave)	Stainless Steel (300 Series)
Spring Washer	Stainless Steel (300 Series)
Hinge Bushing	Aluminum
Rivet	Aluminum

Typical Specification

Manufacturer's ID	Hubbell HBL430PS2W
Description	Plug, Power Supply
Electrical Type	3 Pole + Earth
Max. Rating	30 Amp, 600V AC, 250V DC, 50-400Hz
Configuration	UL 1686, Watertight, C1 Configuration
Certification	UL Listed, UL Standard 1682, UL 50, and UL 1010 (plugs only), CSA Certified to CSA Spec. C22.2 No. 182.1, No. 94 and No. 159 (plugs only), UL Listed and CSA Certified Type 4X

Performance

Electrical	
Dielectric Voltage	Withstands 3,000V AC.
Max. Working Voltage	600V AC RMS (i.e., minimum creepage and clearance distance of 6.4 millimeters, per UL 1682).
Current Interrupting	Certified for current interrupting at full rated current.
Temperature Rise	Max. 30°C temperature rise at full rated current after 50 cycles of overload at 150% of rated current.
Endurance	Up to 1,000 connect and disconnect cycles at full rated current and voltage.

Mechanical

Impact Resistance	Per CSA C22.2, No. 182.1, UL 1682.
Cord Grip Cable Retention	Per CSA C22.2, No. 182.1, UL 1682.
Cord Accommodation	Round portable service cords of diameters commensurate with the device rating as defined in UL Standard 62, CSA C22.2 No. 49 and the harmonized <HAR> European Standards.
Terminal Identification	Terminals identified in accordance with UL 1686 (1, 2, 3, Green).
Product Identification	Identification and ratings are permanently fastened to the device housing.

Environmental

Hose Down & Moisture Resistance	Type 3, 4, 4X per UL 50E and CSA 22.2, No. 94.
Flammability (Enclosure)	UL 94V-0 and CSA C22.2 No. 0.17.
Operating Temperatures	Maximum Continuous 75°C; Minimum -40°C without impact -25° with impact.
Hazardous Location (30, 60 & 100A)	Class I, Division I & II, Groups B, C & D and Class II, Division I & II, Groups F & G per UL 1010 & CSA 22.2, No. 159.

Materials

Housings	Valox® 357 (200A Aluminum).
All Other Materials	Resistant to corrosion and chemical attack.

Watertight Application Guide

Industry	Watertight.
Agriculture	Outdoor for fans, heaters, pumps, etc.
Chemical Processing	Where subject to water, corrosion.
Construction	Outdoors subject to severe weather conditions.
Entertainment	Outdoors subject to severe weather.
Food Processing	Where subject to water, corrosion.
Food Service	Areas subject to wash downs & heavy cleaning.
Light Manufacturing	Subjected to cleaning, solvents & chemicals.
Manufacturing	Where subject to water, corrosion.
Military	Outdoor construction or maintenance.

Valox® is a trademark of SABIC Innovative Plastics, acquired from General Electric Company.
Rynite® is a registered trademark of E.I. DuPont Corp.



Features and Benefits

Style II Insulgrip® Mechanical Interlocks

Hubbell Circuit-Lock® Pin and Sleeve Mechanical Interlocks are a revolutionary design that incorporates a disconnect switch and pin and sleeve receptacle in a compact non-metallic unit. These devices offer maximum safety by preventing users from mating or breaking a circuit under load—Hubbell's interlock mechanism detects the presence of a plug and prevents it from being removed when the switch is in the "ON" position.

It features a high visibility red handle that can be locked to meet OSHA lockout/tagout regulations, and the enclosure door can be locked to prevent unauthorized access. The rugged, corrosion-resistant Type 4X PBT enclosure features adjustable mounting feet for flexible installation, while the receptacle's spring-loaded cover with gasket is dust tight and provides a watertight seal when turned and locked.

The patented Plug-Check™ mechanism detects the presence of the plug. It operates as a clutch to engage the handle with the switch and captures the plug. This action prevents the plug from being removed until the switch is turned OFF.

- Mechanically interlocked to prevent mating and breaking under load
- Available in both IEC and UL1686-C1 Insulgrip® styles
- IEC reverse service units available for safely connecting generators



HBL430MIFS2W



Housing Design

- Non-metallic enclosure meets UL 50E Type 4X (watertight), 12 (dust-tight) and IP66 suitability requirements. Enclosure is molded of rugged thermoplastic PBT to resist abuse, corrosion and enhance safety. All external hardware is stainless steel
- Stainless steel ¼ turn door fasteners for quick, easy access to fuses



Interior Design

- Compact Fused Disconnect Switch accepts **Class "J" fuses**. Fuse holders are top mounted for easy access
- The switch accepts auxiliary contacts for control circuit applications including the ON/OFF control of remote pilot lights or signal for programmable controllers



Safety

- High visibility red handle can be locked in the OFF position as a method of compliance with OSHA lockout requirements. Accepts up to a 5/16 inch padlock shackle
- Replaceable spring-loaded receptacle liftcover with gasket ensures dust tight rating; liftcover provides watertight seal when turned and locked



Contact Carrier

- Thermoset polyester contact carrier provides resistance to electrical tracking and withstands higher temperatures
- Thermoset properties provide excellent dimensional stability, low moisture absorption and superior dielectric strength



Enclosure Door

- Removable door for ease of wiring and installation
- Enclosure door can be locked to prevent unauthorized access. Additionally, if the switch is ON, the door cannot be opened



Installation

- Three molded-in conduit drill points are located on the top, bottom and back surface of enclosure. Conduit hub provided: 30A 1 in. NPT, 60A 1¼ in. NPT
- Conduit hub and adjustable mounting feet (4) are ductile to allow mounting on irregular surfaces

Style II - Fused

Rating				Fused Insulgrip® Mechanical Interlocks	
Amps	Poles and Wires	Receptacle/ Connector Configuration*	Maximum Voltage AC/DC	Mechanical Interlock	Mating Plug
30	3P 4W		600/250		
60	3P 4W		600/250		



HBL430MIFS2W

Style II - Unfused

Rating				Unfused Insulgrip® Mechanical Interlocks	
Amps	Poles and Wires	Receptacle/ Connector Configuration*	Maximum Voltage AC/DC	Mechanical Interlock	Mating Plug
30	3P 4W		600/250		
60	3P 4W		600/250		

Gray Style Switch



HBLACFSNO HBL30MIFRS

Black Style Switch



ACFSNO 30MIFRS

Note: 30A – 1 inch NPT hub supplied; 60A – 1¼ inch hub supplied.

***CAUTION:** To avoid electrical shock, review premises carefully and DO NOT use if Pin and Sleeve configuration (design) is already in a circuit having a rating differing from the rating of this device.

**While in use or with cover closed.

Replacement Auxiliary Contacts

Description	Black Style Switch	Gray Style Switch
Auxiliary contact, normally open, A600 pilot duty, break before break.	ACFSNO	HBLACFSNO
Auxiliary contact, normally closed, A600 pilot duty, break before break.	ACFSNC	HBLACFSNC

Note: Auxiliary contacts are specific to the style switch noted and are NOT interchangeable. All new installations are shipped with gray style switch.

Replacement Switches

Description	Black Style Switch	Gray Style Switch
For 30A fused switches.	30MIFRS	HBL30MIFRS
For 60A fused switches. Gray Style switch will retro fit Black Style switch.	–	HBL60MIFRS
For 30A unfused switches.	30MISRS	HBL30MISRS
For 60A unfused switches. Gray Style switch will retro fit Black Style switch.	–	HBL60MISRS

Note: If replacing a Black Style switch, you must use the 30MIFRS. All other applications can use the Gray Style switch.



MICPK30

Watertight Closure Plug Kits

Description	Catalog Number
For 30A Circuit-Lock® unfused and fused Pin and Sleeve mechanical interlocks.	MICPK30
For 60 and 100A Circuit-Lock® unfused and fused Pin and Sleeve mechanical interlocks.	MICPK60



HBLRFT2

Replacement Mounting Feet

Description	Catalog Number
Replacement mounting feet and screws for 30 and 60A fused mechanical interlocks.	HBLRFT2^A

Note: ^APackage of 10 feet and 10 screws.



Typical Specifications

Manufacturer's Identification	Hubbell HBL460MIFS2W
Description	Fused Insulgrip® Pin and Sleeve Mechanical Interlock
Electrical Type	3 Pole + Earth
Rating	60A, 250VDC/600VAC
Configuration	Per UL 1686 C1
Enclosure Type (UL 50E)	Outdoor - 4X (Watertight, Washdown) Indoor - 12 (Dust Tight, Falling Dirt)
Ingress Protection	IP66 Suitability
Certification	UL Listed for US and Canada

Note: This device provides fused switched control of a plug connected load and includes an interlocking feature to prevent the plug from being disconnected or the door from opening while the receptacle is energized. The switch cannot be turned on until the plug is fully inserted.

Performance

Electrical	
Dielectric Voltage	Withstands 3,000VAC Min.
Max. Working Voltage	250VDC/600VAC.
Current Interrupting	Certified for current interrupting at full rated current and voltage.
Short Circuit Withstand Rating	Suitable for use on a circuit capable of delivering not more than 200,000 RMS symmetrical amperes at the voltage rating of receptacle.
Operations	Mechanical 10,000 cycles minimum.

Materials

Part	Material
Base, Door and Handle	PBT
Conduit Hub	Zinc, 30A – 1 in., 60A – 1¼ in. NPT
Enclosure Gasket and Shaft Seal	Neoprene
Shaft and Mounting Inserts	Brass
Ground Plate	Galvanized Steel
Enclosure Screws and Hinge Spring	Stainless Steel
Hinge Pin	Nickel-Plated Brass
Contact Carrier	Thermoset Polyester

Mechanical	
Impact Resistance	In accordance with UL 746C.
Terminal Identification	In accordance with UL, CSA and international conventions.
Product Ratings	Ratings are part of the external label and molded into the receptacle housing.
Mounting	External adjustable feet.

Environmental	
Moisture Resistance	Outdoor - 4X (Watertight, Washdown); Indoor - 12 (Dust-tight, Falling dirt).
Ingress Protection	IP66 Suitability.
Flammability	UL94-5VA and V-0 Classification.
Operating Temperatures	Max. Continuous +60°C; Min. Continuous -40°C w/o impact.
UV Resistance	All exposed insulating materials are UV stabilized.
Fuse Types	UL Listed Class "J". CSA Certified HRCI-J.

Horsepower Ratings

30A Horsepower Ratings

3 Phase A.C.	Standard	Maximum*
200-240V	3	7.5
480V	5	15
600V	7.5	20

60A Horsepower Ratings

3 Phase A.C.	Standard	Maximum*
200-240V	7.5	15
480V	15	30
600V	15	50

*Note: *Requires time delay fuses.*

Dimensions

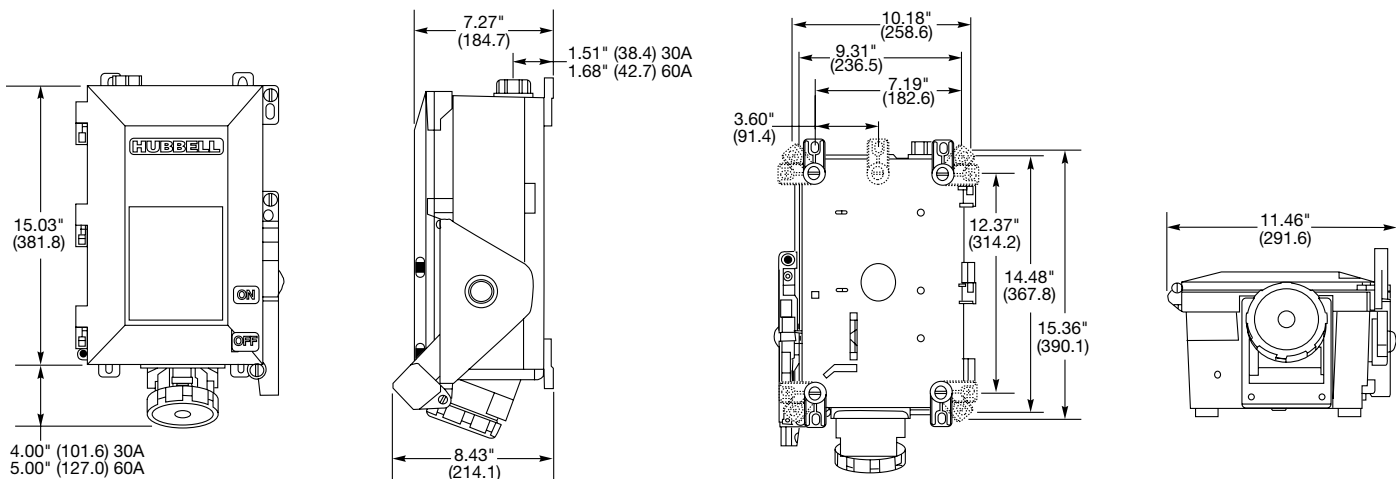

Note: 30A – 1 inch NPT hub supplied; 60A – 1¼ inch hub supplied.

Dimensions in Inches (mm)



Features and Benefits

Hazardous Location Non-Fused Mechanical Interlocks and Plugs

Hubbell's Hazardous Location Line of Non-Fused UL 1686 Mechanical Interlock Disconnect Switches are typically used for applications with the presence of flammable gasses or vapors, ignitable dusts and fibers. They are also suitable for use in outdoor or indoor damp, wet and dirty locations or in areas where frequent wash downs, heavy rain, or water spray routinely occurs.

These switches are compact in size to reduce cost and make it easier to position on the wall or piece of equipment. The enclosures are made of copper-free aluminum and have a polyester/epoxy finish to prevent corrosion. The high visibility handles can be locked out to comply with OSHA lock out/tag out regulations.

VSQ Hazardous Location Ratings

Class I, Div. 1 & 2, Groups B,C,D

Class I, Zones 1 & 2, Groups IIB+H2, IIA

Class II, Div. 1 & 2, Groups F & G

Class III

NEMA 3, 4, 4X, 7 (B,C,D), 9 (F,G)



HBLVP3485



HBLVSQ3034



Housing Design

- Copper-free aluminum construction with electrostatically applied polyester/epoxy finish to prevent corrosion
- Compact NEMA 4X enclosure and footprint allows easy installation in tight locations
- Feed-through construction



Internal Design

- Auxiliary contact (late-make early-break) contact rated 10 amp, 1/3 HP at 125/250V AC can be used for operating pilot lights or starter coils
- Internal switch horsepower rated as "suitable as a motor disconnect"



Safety

- Lockable handle to meet OSHA Lockout/Tagout regulations
- Large visible rotary handle with ON/OFF indicator allows a quick means of disconnecting power
- Handle mechanism is chemical resistant Valox® (TM Sabic) thermoplastic



Plug Locking Ring

- NEMA 4X with receptacle lid turned shut or with plug locking ring tightened



Mechanism

- Plug and switch are interlocked. Switch cannot be turned ON without fully inserted plug Plug cannot be removed with switch in ON position
- Plug held in place when switch is OFF for convenience. Pull operated release mechanism



Fully Interchangeable

- Product is UL1686 and is fully interchangeable with other UL1686 configured and listed devices

Valox® is a trademark of SABIC Innovative Plastics, acquired from General Electric Company.



HBLVSQ3034

30 and 60 Amp Non-Fused UL1686 Mechanical Interlocks and Plugs

Amp	Circuit	Mechanical Interlock	Metallic Plug	Insulgrip Plug
30 Amp 600V AC	2W 3P	HBLVSQ3023	HBLVP3385	HBL330PS2W
	3W 4P	HBLVSQ3034	HBLVP3485	HBL430PS2W
60 AMP 600V AC	2W 3P	HBLVSQ6023	HBLVP6385	HBL360PS2W
	3W 4P	HBLVSQ6034	HBLVP6485	HBL460PS2W

Note: Early break contact comes standard with mechanical interlocks.

HBLVSQ 30 Amp models come standard with 1 inch drilled and tapped conduit openings top and bottom plus two 1 inch x 3/4 inch reducers and one 3/4 inch close-up plug for maximum flexibility. 60 amp models come with one 1 1/2 inch opening on top and bottom and one 1 1/2 inch close-up plug.



HBLVP3485

Horsepower Ratings (VAC)*



Amp	Circuit	120	240	480	600
30 Amp	1Ø	2	5	10	15
	3Ø	3	7.5	15	20
60 Amp	1Ø	–	10	15	20
	3Ø	–	10	25	30

Note: *Internal switch only.

Dimensions

Mechanical Interlocks	A	B	C	D	E	F
30A	5.75 (146)	10.50 (267)	9.75 (248)	3.75 (95)	3.13 (79)	8.13 (206)
60A	8.13 (206)	14.16 (360)	11.28 (287)	4.03 (102)	2.50 (64)	11.38 (289)

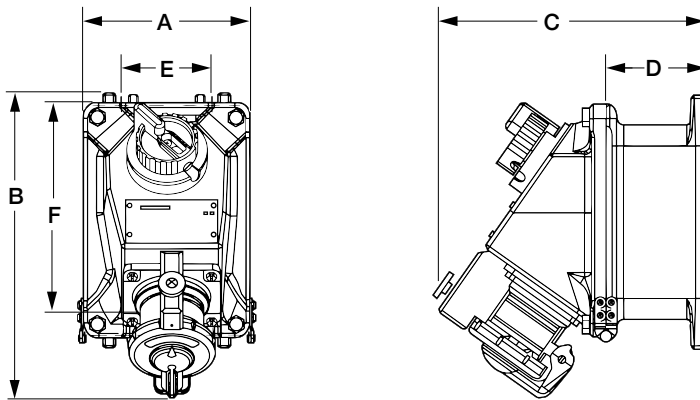

Plugs	A	B	C	D	E
30A Both	6.69 (170)	3.00 (76)	1.88 (48)	5.38 (137)	2.53 (64)
60A, 3 Pole	8.81 (224)	3.38 (86)	2.25 (57)	6.50 (165)	3.00 (76)
60A, 4 Pole	8.81 (224)	3.69 (94)	2.53 (64)	6.50 (165)	3.00 (76)

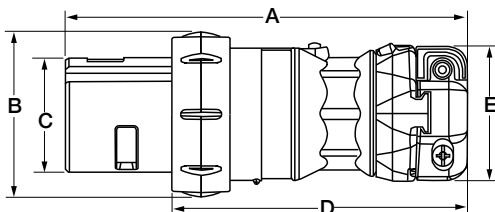

Dimensions in Inches (mm)

Wire Range	30A	60A
Reg. Stranded	#10 – #6	#6 – #4
Extra Flex	#10 – #8	#6 – #4
Grip Range	.55–1.2 (14–30)	.65–1.5 (16–38)