



# Cam-Lok™ Single Pole Connectivity



	Page		Page
<b>Product Selector Guide</b>	<b>F-4</b>	<b>Standard Series</b>	<b>F-53</b>
<b>NEMA Rating System</b>	<b>F-5</b>	E-Z1018	F-53
<b>F-Series</b>	<b>F-6</b>	E1018	F-55
E1010	F-7	E-Z1018 & E1018 Dimensional Information	F-59
E1012	F-8	<b>Vulcanizing Kits &amp; Presses</b>	<b>F-60</b>
F-Series Dimensional Information	F-12	<b>Posi-Lok™</b>	<b>F-62</b>
<b>J-Series</b>	<b>F-14</b>	E0200	F-64
E1015	F-16	E0400	F-67
E-Z1016	F-20	Tools & Accessories	F-73
E1016	F-25	<b>Parts, Tools &amp; Accessories</b>	<b>F-73</b>
E1017	F-41		
J-Series Dimensional Information	F-50		

## Cam-Lok™ Connectors Are The Industry Standard

Cam-Lok™ plugs and receptacles are the original cam-style single pole connectivity solution for motors, generators, indoor and outdoor lighting distribution panels, stand-by power and other industrial power applications



Cooper Interconnect's Cam-Lok™ Single Pole Connectors are specially designed to provide the ultimate in reliable service, even under the most severe operating conditions

- Exclusive double cam principle provides a positive, vibration-proof connection
- Safe and easy assembly with normal hand tools or no tools at all
- All insulators are molded from colorfast material providing quick and easy phase identification
- Panel mount receptacles are insulated for direct mounting to steel panels, eliminating the need for costly insulating boards
- All Cam-Lok™ products are 100% insulated, providing a safe connection



### Cam-Lok™ F-Series Product Applications:

- Welding
- Patch Panels
- Heat Treating



**Realize Time and Cost Savings With Cam-Lok™ Single Pole Connectivity**

Cam-Lok™ plugs and receptacles replace expensive and bulky multi-conductor cables allowing the use of lighter, single-conductor cables rated at higher amperages. Cam-Lok™ connectors also provide the ability to quickly connect and disconnect without tools



**Cam-Lok™ J-Series Product Applications:**

- Portable Power
- Motors
- Generators



**Posi-Lok™ Product Applications:**

- Power Distribution
- Temporary Power
- Emergency Power



## Selecting The Correct Cam-Lok™ Product Series Is Easy

Just identify the cable size, voltage,  
amperage and approval requirements

### F Series

Series	Ampacity Rating (Max.)	Voltage Rating (Max)	Cable Sizes	Approvals
E1010	150	120	#8 - #4	OSHA
E1012	315	120	#2 - 4/0	OSHA

### J Series

Series	Ampacity Rating (Max.)	Voltage Rating (Max)	Cable Sizes	Approvals
E1015	150	600	#8 - #4	UL/CSA
E1016/EZ1016	400	600	#2 - 4/0	UL/CSA
E1017	690	600	250-800 MCM	UL/CSA
E1018/EZ1018	400	600	#2 - 4/0	CSA

### Posi-Lok™

Series	Ampacity Rating (Max.)	Voltage Rating (Max)	Cable Sizes	Approvals
E0200	200	600	#2 - 2/0	UL/CSA
E0400	400	600	#2 - 4/0	UL/CSA

## NEMA Rating (National Electrical Manufacturers Association)

The NEMA rating indicates the level of protection the device has against water and dirt intrusion

Protection From	Device Locations		
	Indoors	Indoors or Outdoors	Outdoors with External Mechanisms
Limited amounts of falling dirt	NEMA Type 1		
Limited amounts of falling dirt and dripping water	NEMA Type 2		
Rain, sleet, falling dirt, windblown dust, damage from ice formation	NEMA Type 3		
Rain, sleet, falling dirt, damage from ice formation	NEMA Type 3R		
Rain, sleet, windblown dust, ice laden operation possible	NEMA Type 3S		
Windblown dust and rain, splashing water, hose-directed water, damage from ice formation	NEMA Type 4		
Corrosion, windblown dust and rain, splashing water, hose-directed water, damage from ice formation	NEMA Type 4X		
Falling dirt and settling airborne dust, lint, fibers and dripping non-corrosive liquids	NEMA Type 5		
Hose-directed water, entry of water during occasional short-term limited depth submersion, damage from ice formation	NEMA Type 6		
Hose-directed water, entry of water during long-term limited depth submersion, damage from ice formation	NEMA Type 6P		
Class I, Division 1, groups A,B,C or D hazardous locations (as defined by NEC®, NFPA 70)	NEMA Type 7 (commonly referred to as explosion-proof)		
Class I, Division 1, groups A,B,C or D hazardous locations (as defined by NEC®, NFPA 70)	NEMA Type 8 (commonly referred to as oil-immersed)		
Class II, Division 1, groups E, F and G hazardous locations (as defined by NEC®, NFPA 70)	NEMA Type 9 (commonly referred to as dust-ignition-proof)		
Meets applicable requirements of the Mine Safety & Health Administration, 30 CFR, Part 18	NEMA Type 10		
Circulating dust, falling dirt, dripping non-corrosive liquids	NEMA Type 12 NEMA Type 12K		
Dust, spraying of water, oil and non-corrosive coolant	NEMA Type 13		

## F-Series Reduced Downtime and Higher Efficiency

Cam-Lok™ F-Series connectors are specifically designed to meet the needs of harsh industrial welding applications. F-Series plugs and receptacles offer superior reliability and safety while reducing downtime

### Applications

- F-Series plugs and receptacles are specifically designed for industrial applications where electrical equipment is exposed to harsh environments
- They are ideal for welding equipment, power distribution panels, patch panels and heat treating applications and are insulated for safety with reinforced thermoplastic or epoxy, or watertight elastomeric

### Specifications

#### Electrical Ratings

- 120 Volts AC
- Up to 315 Amps Continuous, 550 Amps Intermittent

#### Temperature Ratings

- Standard: Up to 105°C
- High Temperature: Up to 180°C (356°F)

#### Materials

- Accepts cable sizes: #8 AWG - 4/0
- Insulator material: Reinforced thermoplastic (E1010, E1012), reinforced epoxy (E1012 High-Temperature) or elastomeric (E1012 only)
- Contact material: Brass or silver-plated brass Environmental
- NEMA 3

#### Certifications

- Meets OSHA requirements for welding connectors
- Meets NEC® Code Requirements for listed connectors that are of the locking type

### Features

- 1 Chemical-resistant, reinforced thermoplastic material
  - 2 Double-cam contact for superior mating
  - 3 Color-coded molding for easy phasing identification
  - 4 Single set screw termination for simple assembly
  - 5 OSHA compliant
  - 6 Proprietary high-temperature rated reinforced epoxy (high temp version only)
  - 7 Easy interconnectability
  - 8 Exclusive Cam-Lok action for high conductivity
  - 9 Double set screw termination for added strength
-

## F-Series E1010 Plugs & Receptacles

Cable Size #8 – #4 AWG  
120V/AC  
Up to 150A Continuous, 200A Intermittent

### F-Series E1010, Reinforced Thermoplastic

#### Features

- Double cam principle provides a positive, vibration-proof connection
- Self-compensating for wear
- No moving contact surfaces, eliminating arcing or burning
- Superior electro-mechanical connections
- Locked contacts will withstand a pulling force of 1,000 lbs
- 1/3 of a turn assures a high pressure contact approaching 600 lbs. per sq. in. providing minimum resistance
- Contacts carefully machined from a high conductivity brass to a smooth sliding fit and easy locking action
- Reinforced thermoplastic insulators molded from colorfast material, color-coded for easy identification
- Panel receptacles are safety insulated for direct mounting to steel panels
- Accepts a wide range of cable sizes



E1010-61



E1010-308

#### Male Plugs

	Cable Size	Color	Complete Part No.	Insulator Part No.
Set-Screw	#8-#4	RD	E1010-61	201281-410RM
		BK	E1010-62	201281-410BM
Solder	#8-#4	RD	E1010-101	201281-410RM
		BK	E1010-102	201281-410BM

#### Female Plugs

Complete Part No.	Insulator Part No.	Retaining Pin Part No.
E1010-71	201281-410RF	100091-2
E1010-72	201281-410BF	100091-2
E1010-111	201281-410RF	100091-2
E1010-112	201281-410BF	100091-2

#### Female Terminal Connectors

Cable Size	Color	Angle Style Part No.	Offset Style Part No.
#8-#4	RD	E1010-181	E1010-201
	BK	E1010-182	E1010-202

#### High Impact Plastic Receptacles

Cable Size	Color	Angle Style Part No.	Description
#8-#4	RD	E1010-301	Female Receptacle
	BK	E1010-302	Female Receptacle
	RD	E1010-307	Male Receptacle
	BK	E1010-308	Male Receptacle

For E1010 Reinforced Thermoplastic Drawings, see Page F-12  
To order single packaged products add a "K" suffix to the complete part number

#### Color Information:

BK (Black), RD (Red)



**Dimensional Information:** F-12 **Testing & Code Compliance:** OSHA Compliant **Material Characteristics:** Insulator: Reinforced Thermoplastic, Temperature Rating: -40° C to 105° C

Specifications and availability are subject to change without notice.



**F-Series  
E1012 Plugs**

Cable Size #2 AWG – 4/0  
120V/AC  
Up to 315A Continuous, 550A Intermittent



E1012-66



E1012-71

**F-Series E1012, Reinforced Thermoplastic****Features**

- Double cam principle provides a positive, vibration-proof connection
- Self-compensating for wear
- No moving contact surfaces, eliminating arcing or burning
- Superior electro-mechanical connections
- Locked contacts will withstand a pulling force of 1,000 lbs
- Accepts a wide range of cable sizes
- 1/3 of a turn assures a high pressure contact approaching 600 lbs. per sq. in. providing minimum resistance
- Contacts carefully machined from a high conductivity brass to a smooth sliding fit and easy locking action
- Reinforced thermoplastic insulators molded from colorfast material, color-coded for easy identification

**Set Screw Male Plugs**

Cable Size	Color	Complete Part No.	Insulator Part No.
#2-1/0	RD	E1012-61	201281-612RM
	BK	E1012-62	201281-612BM
1/0-3/0	RD	E1012-63	201281-712RM
	BK	E1012-64	201281-712BM
3/0-4/0	RD	E1012-65	201281-812RM
	BK	E1012-66	201281-812BM

**Set Screw Female Plugs**

Complete Part No.	Insulator Part No.	Retaining Pin Part No.
N/A	N/A	100091-4
N/A	N/A	100091-4
E1012-71	201281-712RF	100091-5
E1012-72	201281-712BF	100091-5
E1012-73	201281-812RF	100091-6
E1012-74	201281-812BF	100091-6

**Solder Male Plugs**

Cable Size	Color	Complete Part No.	Insulator Part No.
#2-1/0	RD	E1012-101	201281-612RM
	BK	E1012-102	201281-612BM
1/0-3/0	RD	E1012-103	201281-712RM
	BK	E1012-104	201281-712BM
3/0-4/0	RD	E1012-105	201281-812RM
	BK	E1012-106	201281-812BM

**Solder Female Plugs**

Complete Part No.	Insulator Part No.	Retaining Pin Part No.
N/A	N/A	100091-4
N/A	N/A	100091-4
E1012-111	201281-712RF	100091-5
E1012-112	201281-712BF	100091-5
E1012-113	201281-812RF	100091-6
E1012-114	201281-812BF	100091-6

For E1012 Reinforced Thermoplastic Drawings, see Page F-12  
To order single packaged products add a "K" suffix to the complete part number

**Color Information:**

BK (Black), RD (Red)



**Dimensional Information:** F-12 **Testing & Code Compliance:** OSHA Compliant **Material Characteristics:** Insulator: Reinforced Thermoplastic, Temperature Rating: -40° C to 105° C

Specifications and availability are subject to change without notice.

**F-Series  
E1012 Plugs**

Cable Size #2 AWG – 4/0  
120V/AC  
Up to 315A Continuous, 550A Intermittent

**F-Series E1012, Elastomeric**

**Features**

- Double cam principle provides a positive, vibration-proof connection
- Self-compensating for wear
- No moving contact surfaces, eliminating arcing or burning
- Superior electro-mechanical connections
- Locked contacts will withstand a pulling force of 1,000 lbs
- Accepts a wide range of cable sizes
- 1/3 of a turn assures a high pressure contact approaching 600 lbs. per sq. in. providing minimum resistance
- Contacts carefully machined from a high conductivity brass to a smooth sliding fit and easy locking action
- Watertight elastomeric insulators molded from colorfast material, color-coded for easy identification



E1012-8350



E1012-8377

**Single Set Screw Male Plugs**

Cable Size	Color	Complete Part No.	Contact Part No.	Insulator Part No.
#2-2/0	BK	E1012-8300	A200081-1	A200068-19
	RD	E1012-8302	A200081-1	A200068-21
2/0-4/0	BK	E1012-8312	A200080-1	A200068-13
	RD	E1012-8314	A200080-1	A200068-15

**Single Set Screw Female Plugs**

Complete Part No.	Contact Part No.	Insulator Part No.
E1012-8325	A200067-1	A200069-19
E1012-8327	A200067-1	A200069-21
E1012-8337	A200066-1	A200069-13
E1012-8339	A200066-1	A200069-15

**Double Set Screw Male Plugs**

Cable Size	Color	Complete Part No.	Contact Part No.	Insulator Part No.
#2-2/0	BK	E1012-8350	A200643-1	A200068-19
	RD	E1012-8352	A200643-1	A200068-21
2/0-4/0	BK	E1012-8362	A200644-1	A200068-13
	RD	E1012-8364	A200644-1	A200068-15

**Double Set Screw Female Plugs**

Complete Part No.	Contact Part No.	Insulator Part No.
E1012-8375	A200640-1	A200069-19
E1012-8377	A200640-1	A200069-21
E1012-8387	A200642-1	A200069-13
E1012-8389	A200642-1	A200069-15

**Crimp Or Solder Male Plugs**

Cable Size	Color	Complete Part No.	Contact Part No.	Insulator Part No.
#2-#1	BK	E1012-8006	A200036-30	A200068-19
	RD	E1012-8008	A200036-30	A200068-21
1/0-2/0	BK	E1012-8012	A200036-31	A200068-19
	RD	E1012-8014	A200036-31	A200068-21
3/0-4/0	BK	E1012-8030	A200038-30	A200068-13
	RD	E1012-8032	A200038-30	A200068-15

**Crimp Or Solder Female Plugs**

Complete Part No.	Contact Part No.	Insulator Part No.
E1012-8056	A200037-35	A200069-19
E1012-8058	A200037-35	A200069-21
E1012-8062	A200037-36	A200069-19
E1012-8064	A200037-36	A200069-21
E1012-8080	A200035-53	A200069-13
E1012-8082	A200035-53	A200069-15

For E1012 Elastomeric Drawings, see Page F-12  
To order single packaged products add a "K" suffix to the complete part number

**Color Information:**  
BK (Black), RD (Red)



**Dimensional Information:** F-12 **Testing & Code Compliance:** OSHA Compliant **Material Characteristics:** Insulator: TPE, Temperature Rating: -40° C to 105° C

Specifications and availability are subject to change without notice.

## F-Series E1012 Receptacles & Accessories

Cable Size #2 AWG – 4/0

120V/AC

Up to 315A Continuous, 550A Intermittent



A201317-6



E1012-2324

### F-Series E1012, Reinforced Thermoplastic or Elastomeric

#### Features

- Double cam principle provides a positive, vibration-proof connection
- Self-compensating for wear
- No moving contact surfaces, eliminating arcing or burning
- Superior electro-mechanical connections.
- Locked contacts will withstand a pulling force of 1,000 lbs
- 1/3 of a turn assures a high pressure contact approaching 600 lbs. per sq. in. providing minimum resistance
- Contacts carefully machined from a high conductivity brass to a smooth sliding fit and easy locking action
- Product body molded from colorfast material, color-coded for easy identification
- Panel receptacles are safety insulated for direct mounting to steel panels
- Accepts a wide range of cable sizes

#### Female Terminal Connectors

Cable Size	Color	Angle Style Part No.	Offset Style Part No.
#2-3/0	RD	A201317-1	A201317-5
	BK	A201317-2	A201317-6
4/0	RD	A201317-3	N/A
	BK	A201317-4	N/A

Bolt Hole: 1/2"

#### Three Way "T" Connectors

Cable Size	Color	Paralleling "T" Part No. M-M-F	Tapping "T" Part No. M-F-F
#2-4/0	RD	E1012-2324	E1012-2314
	BK	E1012-2326	E1012-2312

### High-Impact Receptacles

Cable Size	Color	Complete Part No.	Description	Contact Material
#2-3/0	RD	E1012-301	Female Receptacle	Brass
	BK	E1012-302	Female Receptacle	Brass
#2-4/0	RD	E1012-303	Female Receptacle	Brass
	BK	E1012-304	Female Receptacle	Brass
	RD	E1012-305	Female Receptacle	Copper
	BK	E1012-306	Female Receptacle	Copper
	RD	E1012-307	Male Receptacle	Brass
	BK	E1012-308	Male Receptacle	Brass

Maximum Torque: 20 ft. lbs.

For E1012 Reinforced Thermoplastic or Elastomeric Drawings, see Page F-13

To order single packaged products add a "K" suffix to the complete part number

#### Color Information:

BK (Black), RD (Red)



**Dimensional Information:** F-13 **Testing & Code Compliance:** OSHA Compliant **Material Characteristics:** Insulator: Reinforced Thermoplastic or TPE, Temperature Rating: -40° C to 105° C

**Specifications and availability are subject to change without notice.**

## F-Series E1012 High Temperature Plugs & Receptacles

Cable Size 2/0 – 4/0  
120V/AC  
Up to 400A Continuous, 670A Intermittent

### F-Series E1012 High Temperature, Reinforced Epoxy

#### Features

- Double cam principle provides a positive, vibration-proof connection
- Self-compensating for wear
- No moving contact surfaces, eliminating arcing or burning
- Superior electro-mechanical connections
- Locked contacts will withstand a pulling force of 1,000 lbs
- 1/3 of a turn assures a high pressure contact approaching 600 lbs. per sq. in. providing minimum resistance
- Contacts carefully machined from a high conductivity brass or silver-plated brass to a smooth sliding fit and easy locking action
- Insulating material designed to deliver superior performance in high temperature applications up to 356° F (180°C)



E1012-88



E1012-502

### Double Set Screw Male Plugs

Cable Size	Contact Material	Color	Complete Part No.	Contact Part No.	Insulator Part No.	Retaining Pin Part No.
2/0-4/0	Brass	BK	E1012-88	200639-4	101037-2	100091-22
	Silver Plate	BK	E1012-85	200639-9	101037-2	100091-22

### Double Set Screw Female Plugs

Cable Size	Contact Material	Color	Complete Part No.	Contact Part No.	Insulator Part No.	Retaining Pin Part No.
2/0-4/0	Brass	BK	E1012-98	200641-10	101036-2	100091-22
	Silver Plate	BK	E1012-95	200641-11	101036-2	100091-22

### High Temperature Receptacles

Cable Size	Part No.	Color	Description	Contact Material
2/0-4/0	E1012-502	BK	Female Receptacle	Brass
	E1012-508	BK	Male Receptacle	Brass

For E1012 High Temperature, Reinforced Epoxy Drawings, see Page F-13  
To order single packaged products add a "K" suffix to the complete part number

#### Color Information:

BK (Black)



(Black)

**Dimensional Information:** F-13 **Testing & Code Compliance:** OSHA Compliant **Material Characteristics:** Insulator: Reinforced Thermoplastic or TPE, Temperature Rating: -40° C to 180° C

Specifications and availability are subject to change without notice.

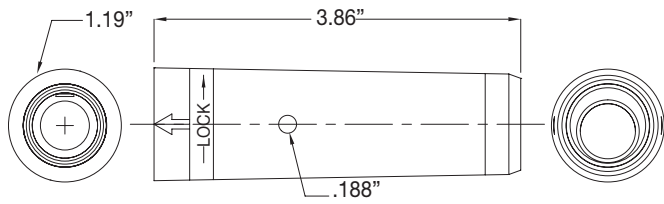
**F-Series E1010, Reinforced Thermoplastic**

Male &amp; Female Plug

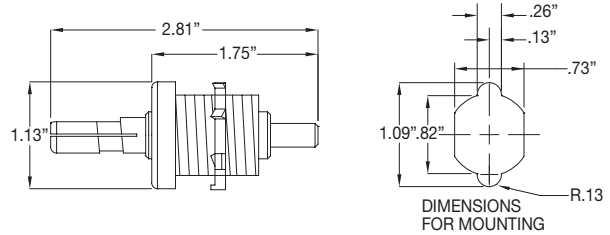

Male Receptacle

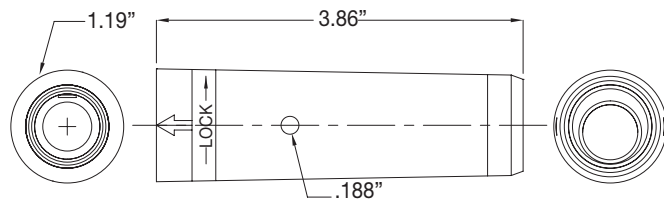
**F-Series E1012, Reinforced Thermoplastic**

Male &amp; Female Plug

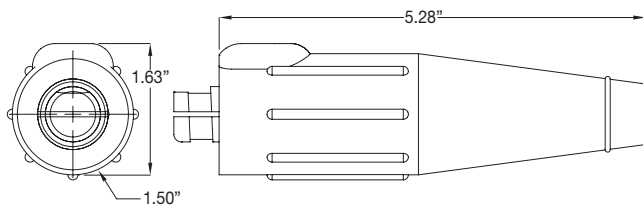
**F-Series E1012, Elastomeric**

Male Plug

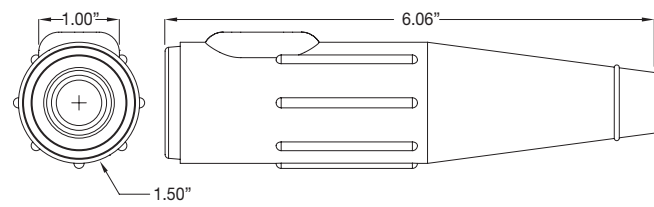

Female Plug

Specifications and availability are subject to change without notice.

F-Series E1012, Reinforced Thermoplastic

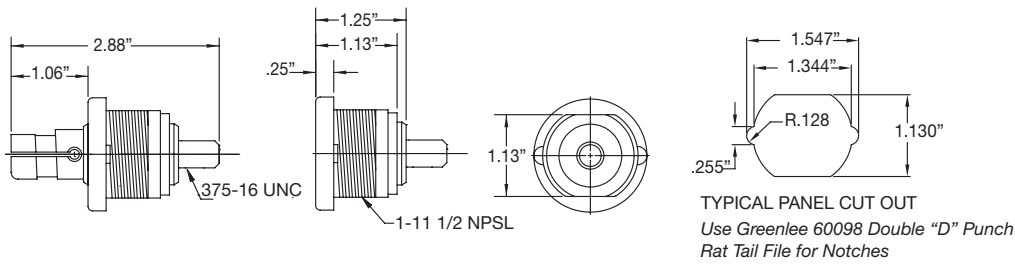

Male & Female Receptacles

F-Series E1012 High Temperature, Reinforced Epoxy

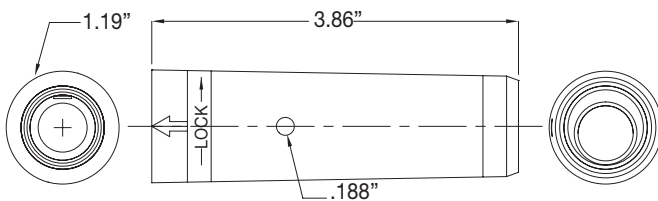

Male & Female High Temperature Plug

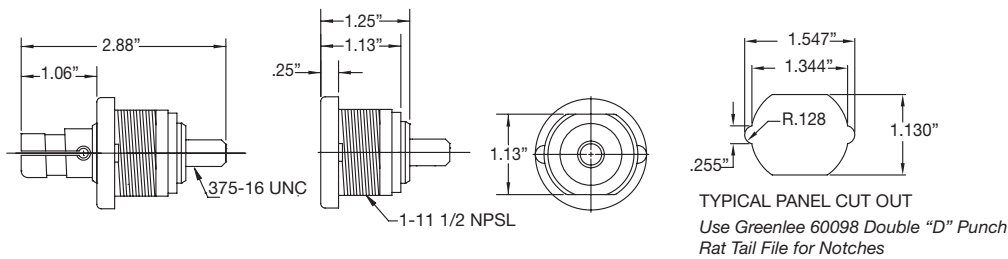

Male & Female High Temperature Receptacles

Specifications and availability are subject to change without notice.

## Designed For Reliable, Portable, Quick and Safe Single Pole Connections

Cam-Lok™ J-Series connectors are specifically designed to meet the needs of demanding portable applications. J-Series plugs and receptacles are the proven industry standard single pole connectors for reliability and service with added safety

### Applications

- J-Series plugs and receptacles are specifically designed for industrial power distribution applications requiring quick, tool-free connections
- Ideal for portable power, power distribution, motors, generators and entertainment applications; J-Series replaces traditional hardwiring while cutting downtime and maintenance
- J-Series connectors are insulated, shatter/crack resistant and water tight plus heat, weather, ozone, oil and abrasion resistant

### Specifications

#### Electrical Ratings

- 600 Volts AC/DC
- 690 Amps Continuous

#### Temperature Ratings

- -40° C to 105° C

#### Materials

- Accepts cable sizes:  
#8 AWG – 800 MCM
- Insulator material:  
Elastomeric or Rubber
- Contact material:  
Brass or Copper Environmental
- NEMA 3R or NEMA 4

#### Certifications

- Listed to UL498, file no. E67181
- CSA certified to C22.2, no. 182.3 LR13963



## Discover How Cam-Lok™ J-Series Connectivity Outperforms Hardwiring

Cam-Lok™ J-Series connectors quickly replace traditional hardwiring and offer more safety with integrated watertight insulators and a strain relief system. Plus, a wide range of sizes, colors and accessories are available for complete flexibility

### Features & Benefits

**1** Non-metallic retaining screw provides safe, strong and reliable contact retention

**2** Easy assembly with standard tools

**3** Retaining screw snaps into place to prevent loss

**4** E-Z align drive pin increases torque and longitudinal strength 300%

**5** NEMA 3R rating when mated

**6** Accommodates a wide range of cable sizes: #2 – 4/0

**7** Integrated strain relief system's retaining wire prevents cable jacket pull-away

**8** Non-vulcanized E1016 & EZ1016 plugs feature a high-strength, molded-in-place locking ring to capture and secure the insulator to the contact

**9** Double set screw termination for added strength (crimp also available)

**10** Fully insulated for direct mounting to steel panels

**11** Threaded stud and double set screw receptacles available (other terminations available)

**12** High impact-resistant thermoplastic protects receptacles from damage

**13** Snapback covers provide NEMA 3R environmental seal



**J-Series  
E1015 Plugs**

Cable Size #8 – #4 AWG  
600V AC/DC, Up to 150A Continuous  
NEMA 3R



E1015-8313



E1015-8333

**J-Series E1015, Elastomeric, Non-Vulcanized, Single Set Screw Connection****Features**

- Double cam principle provides a positive, vibration-proof connection
- Self-compensating for wear
- No moving contact surfaces, eliminating arcing or burning
- Superior electro-mechanical connections.
- Locked contacts will withstand a pulling force of 1,000 lbs
- 1/3 of a turn assures a high pressure contact approaching 600 lbs. per sq. in. providing minimum resistance
- Accepts a wide range of cable sizes
- Contacts carefully machined from a high conductivity brass to a smooth sliding fit and easy locking action
- Watertight elastomeric insulators molded from colorfast material, color-coded for easy phase identification
- Recessed contacts protected by insulating jacket that extends beyond contact ends for safety
- Integrated strain relief system features a retaining wire that prevents cable jacket pull-away and bare conductor exposure

**Set Screw Non-Vulcanized Male Plugs**

Cable Size	Color	Complete Part No.	Contact Only Part No.	Insulator Only Part No.
#8-#4	BK	E1015-8306	A100864-1	A100869-7
	RD	E1015-8308	A100864-1	A100869-9
	GR	E1015-8310	A100864-1	A100869-11
	WH	E1015-8311	A100864-1	A100869-12
	BU	E1015-8313	A100864-1	A100869-14
	BRN	E1015-8314	A100864-1	A100869-15
	ORG	E1015-8309	A100864-1	A100869-10
	YEL	E1015-8307	A100864-1	A100869-8

**Set Screw Non-Vulcanized Female Plugs**

Cable Size	Color	Complete Part No.	Contact Only Part No.	Insulator Only Part No.
#8-#4	BK	E1015-8331	A100865-1	A100868-7
	RD	E1015-8333	A100865-1	A100868-9
	GR	E1015-8335	A100865-1	A100868-11
	WH	E1015-8336	A100865-1	A100868-12
	BU	E1015-8338	A100865-1	A100868-14
	BRN	E1015-8339	A100865-1	A100868-15
	ORG	E1015-8334	A100865-1	A100868-10
	YEL	E1015-8332	A100865-1	A100868-8

For E1015 Elastomeric, Non-Vulcanized, Single Set Screw Connection Drawings, see Page F-50  
To order single packaged products add a "K" suffix to the complete part number

**Color Information:**

BK (Black), RD (Red), GR (Green), WH (White), BU (Blue), BRN (Brown), ORG (Orange), YEL (Yellow)



**Dimensional Information:** F-50 **Testing & Code Compliance:** Listed to UL498, file no. E67181, CSA Certified to C22.2, no. 182.3-M1987, file no. LR13963 **Material Characteristics:** Insulator: TPE, Environmental: NEMA 3R, Temperature Rating:-40° C to 105° C

**Specifications and availability are subject to change without notice.**

## J-Series E1015 Plugs

Cable Size #8 – #4 AWG  
600V AC/DC, Up to 150A Continuous  
NEMA 4

### J-Series E1015, Rubber, Vulcanized, Crimp Connection

#### Features

- Vulcanizing permanently affixes plug insulator to cable for maximum protection against bare conductors, water, all kinds of weather, corrosion and other contaminants (requires vulcanizing kit/presses)
- Vulcanizing also reduces cable breakage by distributing flexing over a wide area for an effective strain relief system
- Double cam principle provides a positive, vibration-proof connection
- Self-compensating for wear
- No moving contact surfaces, eliminating arcing or burning
- Superior electro-mechanical connections
- Locked contacts will withstand a pulling force of 1,000 lbs
- 1/3 of a turn assures a high pressure contact approaching 600 lbs. per sq. in. providing minimum resistance
- Contacts carefully machined from a high conductivity brass to a smooth sliding fit and easy locking action
- Watertight neoprene insulators molded from colorfast material, color-coded for easy phase identification
- Recessed contacts protected by insulating jacket that extends beyond contact ends for safety



E1015-2



E1015-55

### Crimp Vulcanized Male Plugs

Cable Size	Color	Complete Part No.	Contact Only Part No.	Insulator Only Part No.
#8-#4	BK	E1015-1	A100087-1	A100092-1
	RD	E1015-3	A100087-1	A100092-3
	GR	E1015-5	A100087-1	A100092-5
	WH	E1015-6	A100087-1	A100092-6
	BU	E1015-19	A100087-1	A100092-7
	BRN	E1015-22	A100087-1	A100092-8
	ORG	E1015-4	A100087-1	A100092-4
	YEL	E1015-2	A100087-1	A100092-2

### Crimp Vulcanized Female Plugs

Cable Size	Color	Complete Part No.	Contact Only Part No.	Insulator Only Part No.
#8-#4	BK	E1015-50	A100088-1	A100093-1
	RD	E1015-52	A100088-1	A100093-3
	GR	E1015-54	A100088-1	A100093-5
	WH	E1015-55	A100088-1	A100093-6
	BU	E1015-47	A100088-1	A100093-14
	BRN	E1015-44	A100088-1	A100093-15
	ORG	E1015-53	A100088-1	A100093-4
	YEL	E1015-51	A100088-1	A100093-2

For E1015 Rubber, Vulcanized, Crimp Connection Drawings, see Page F-50  
To order single packaged products add a "K" suffix to the complete part number

#### Color Information:

BK (Black), RD (Red), GR (Green), WH (White), BU (Blue), BRN (Brown), ORG (Orange), YEL (Yellow)



**Dimensional Information:** F-50 **Testing & Code Compliance:** Listed to UL498, file no. E67181, CSA Certified to C22.2, no. 182.3-M1987, file no. LR13963 **Material Characteristics:** Insulator: Rubber, Environmental: NEMA 4, Temperature Rating: -40° C to 105° C

Specifications and availability are subject to change without notice.

## J-Series E1015 Receptacles & Terminals

Cable Size #8 – #4 AWG  
600V AC/DC, Up to 150A Continuous  
NEMA 3R



E1015-1604



E1015-1625

### J-Series E1015, Elastomeric or Rubber

#### Features

- Double cam principle provides a positive, vibration-proof connection
- Self-compensating for wear
- No moving contact surfaces, eliminating arcing or burning
- Superior electro-mechanical connections
- Locked contacts will withstand a pulling force of 1,000 lbs
- 1/3 of a turn assures a high pressure contact approaching 600 lbs. per sq. in. providing minimum resistance
- Contacts carefully machined from a high conductivity brass to a smooth sliding fit and easy locking action
- Product body molded from colorfast material, color-coded for easy phase identification
- Receptacles are watertight elastomeric, terminals are rubber
- Recessed contacts protected by insulating jacket that extends beyond contact ends for safety
- Receptacles are safety insulated for direct mounting to steel panels

Threaded Studs		Male Receptacle	Female Receptacle
Cable Size	Color	Complete Part No.	Contact Only Part No.
#8-#4	BK	E1015-1600	E1015-1625
	RD	E1015-1602	E1015-1627
	GR	E1015-1604	E1015-1629
	WH	E1015-1605	E1015-1630
	BU	E1015-1606	E1015-1631
	BRN	E1015-1607	E1015-1632
	ORG	E1015-1603	E1015-1628
	YEL	E1015-1601	E1015-1626

Stud Size: 5/16", Torque: 15 ft. lbs.

### Female Terminals

Cable Size	Color	Angle Style	Offset Style
#8-#4	BK	E1015-575	E1015-625
	RD	E1015-577	E1015-627
	GR	E1015-579	E1015-629
	WH	E1015-580	E1015-630
	BU	E1015-581	E1015-631
	BRN	E1015-589	E1015-632
	ORG	E1015-578	E1015-628
	YEL	E1015-576	E1015-626

For E1015 Elastomeric or Rubber Drawings, see Page F-50  
To order single packaged products add a "K" suffix to the complete part number

#### Color Information:

BK (Black), RD (Red), GR (Green), WH (White), BU (Blue), BRN (Brown), ORG (Orange), YEL (Yellow)



**Dimensional Information:** F-50 **Testing & Code Compliance:** Listed to UL498, file no. E67181, CSA Certified to C22.2, no. 182.3-M1987, file no. LR13963 **Material Characteristics:** Body: TPE (Receptacles) or Rubber (Terminals), Environmental: NEMA 3R, Temp Rating: -40° C to 105° C

Specifications and availability are subject to change without notice.

**J-Series E1015 Accessories** | 600V AC/DC, Up to 150A Continuous  
NEMA 3R

**J-Series E1015, Rubber**

- Features**
- Double cam principle provides a positive, vibration-proof connection
  - Self-compensating for wear
  - No moving contact surfaces, eliminating arcing or burning
  - Superior electro-mechanical connections
  - Locked contacts will withstand a pulling force of 1,000 lbs
  - 1/3 of a turn assures a high pressure contact approaching 600 lbs. per sq. in. providing minimum resistance
  - Contacts carefully machined from a high conductivity brass to a smooth sliding fit, even before to locking
  - Watertight neoprene insulators molded from colorfast material, color-coded for easy phase identification
  - Recessed contacts protected by insulating jacket that extends beyond contact ends for safety



E1015-2314



A100792-1

**Three Way "T" Connectors** | **Adaptors**

Color	Paralleling "T" Complete Part No. M-M-F	Tapping "T" Complete Part No. M-F-F	Double Female Complete Part No.	Double Male Complete Part No.	Male - Female Complete Part No.
BK	E1015-2324	E1015-2312	E1015-2352	E1015-2362	E1015-2336
RD	E1015-2326	E1015-2314	E1015-2354	E1015-2364	E1015-2338
GR	E1015-2328	E1015-2316	E1015-2356	E1015-2366	E1015-2340
WH	E1015-2329	E1015-2317	E1015-2357	E1015-2367	E1015-2341
BU	E1015-2348	E1015-2350	E1015-2358	E1015-2368	E1015-2361
BRN	E1015-2342	E1015-2370	E1015-2359	E1015-2369	E1015-2371
ORG	E1015-2327	E1015-2315	E1015-2355	E1015-2365	E1015-2339
YEL	E1015-2325	E1015-2313	E1015-2353	E1015-2363	E1015-2337

**Protective Caps (Not UL Listed or CSA Certified)**

Color	Male	Female
BK	A100793-1	A100792-1
RD	A100793-3	A100792-3
GR	A100793-5	A100792-5
WH	A100793-6	A100792-6
BU	A100793-7	A100792-13
BRN	A100793-8	A100792-7
ORG	A100793-4	A100792-4
YEL	A100793-2	A100792-2

For E1015 Rubber Drawings, see Page F-50  
To order single packaged products add a "K" suffix to the complete part number

**Color Information:**  
BK (Black), RD (Red), GR (Green), WH (White), BU (Blue), BRN (Brown), ORG (Orange), YEL (Yellow)

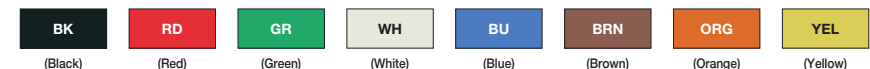

**Dimensional Information:** F-50 **Testing & Code Compliance:** Listed to UL498, file no. E67181, CSA Certified to C22.2, no. 182.3-M1987, file no. LR13963 **Material Characteristics:** Body: Rubber, Environmental: NEMA 3R, Temperature Rating: -40° C to 105° C

Specifications and availability are subject to change without notice.

**J-Series  
E-Z1016 Plugs**

Cable Size #2 AWG – 2/0  
600V AC/DC, Up to 300A Continuous  
NEMA 3R



E-Z1016-8354



E-Z1016-8380

**J-Series E-Z1016, Elastomeric, Non-Vulcanized, Double Set Screw Connection****Features**

- E-Z assembly and disassembly-no tools needed
- Double cam principle provides a positive, vibration-proof connection
- Self-compensating for wear
- No moving contact surfaces, eliminating arcing or burning
- Superior electro-mechanical connections
- Locked contacts will withstand a pulling force of 1,000 lbs
- 1/3 of a turn assures a high pressure contact approaching 600 lbs. per sq. in. providing minimum resistance
- Accepts a wide range of cable sizes
- Contacts carefully machined from a high conductivity brass to a smooth sliding fit and easy locking action
- Watertight elastomeric insulators molded from colorfast material, color-coded for easy phase identification
- Recessed contacts protected by insulating jacket that extends beyond contact ends for safety
- Integrated strain relief system features a retaining wire that prevents cable jacket pull-away and bare conductor exposure
- Plugs feature a high-strength, molded-in-place locking ring to capture and secure the insulator to the contact

**Double Set Screw Non-Vulcanized Male Plugs**

Cable Size	Color	Complete Part No.	Contact Only Part No.	Insulator Only Part No.
#2-2/0	BK	E-Z1016-8350	A200630-1	E-Z200074-19
	RD	E-Z1016-8352	A200630-1	E-Z200074-21
	GR	E-Z1016-8354	A200630-1	E-Z200074-23
	WH	E-Z1016-8355	A200630-1	E-Z200074-24
	BU	E-Z1016-8356	A200630-1	E-Z200074-38
	BRN	E-Z1016-8357	A200630-1	E-Z200074-47
	ORG	E-Z1016-8353	A200630-1	E-Z200074-22
	YEL	E-Z1016-8351	A200630-1	E-Z200074-20

**Double Set Screw Non-Vulcanized Female Plugs**

Cable Size	Color	Complete Part No.	Contact Only Part No.	Insulator Only Part No.
#2-2/0	BK	E-Z1016-8375	A200640-3	E-Z200075-19
	RD	E-Z1016-8377	A200640-3	E-Z200075-21
	GR	E-Z1016-8379	A200640-3	E-Z200075-23
	WH	E-Z1016-8380	A200640-3	E-Z200075-24
	BU	E-Z1016-8381	A200640-3	E-Z200075-44
	BRN	E-Z1016-8382	A200640-3	E-Z200075-52
	ORG	E-Z1016-8378	A200640-3	E-Z200075-22
	YEL	E-Z1016-8376	A200640-3	E-Z200075-20

For E-Z1016 Elastomeric, Non-Vulcanized, Double Set Screw Connection, see Page F-50  
To order single packaged products add a "K" suffix to the complete part number

**Color Information:**

BK (Black), RD (Red), GR (Green), WH (White), BU (Blue), BRN (Brown), ORG (Orange), YEL (Yellow)



**Dimensional Information:** F-50 **Testing & Code Compliance:** Listed to UL498, file no. E67181, CSA Certified to C22.2, no. 182.3-M1987, file no. LR13963 **Material Characteristics:** Insulator: TPE, Environmental: NEMA 3R, Temperature Rating: -40° C to 105° C

**Specifications and availability are subject to change without notice.**

## J-Series E-Z1016 Plugs

Cable Size 2/0 – 4/0  
600V AC/DC, Up to 400A Continuous  
NEMA 3R

### J-Series E-Z1016, Elastomeric, Non-Vulcanized, Double Set Screw Connection

#### Features

- E-Z assembly and disassembly-no tools needed
- Double cam principle provides a positive, vibration-proof connection
- Self-compensating for wear
- No moving contact surfaces, eliminating arcing or burning
- Superior electro-mechanical connections
- Locked contacts will withstand a pulling force of 1,000 lbs
- 1/3 of a turn assures a high pressure contact approaching 600 lbs. per sq. in. providing minimum resistance
- Accepts a wide range of cable sizes
- Contacts carefully machined from a high conductivity brass to a smooth sliding fit and easy locking action
- Watertight elastomeric insulators molded from colorfast material, color-coded for easy phase identification
- Recessed contacts protected by insulating jacket that extends beyond contact ends for safety
- Integrated strain relief system features a retaining wire that prevents cable jacket pull-away and bare conductor exposure
- Plugs feature a high-strength, molded-in-place locking ring to capture and secure the insulator to the contact



E-Z1016-8368



E-Z1016-8389

### Double Set Screw Non-Vulcanized Male Plugs

Cable Size	Color	Complete Part No.	Contact Only Part No.	Insulator Only Part No.
2/0-4/0	BK	E-Z1016-8362	A200639-1	E-Z200074-60
	RD	E-Z1016-8364	A200639-1	E-Z200074-62
	GR	E-Z1016-8366	A200639-1	E-Z200074-64
	WH	E-Z1016-8367	A200639-1	E-Z200074-65
	BU	E-Z1016-8368	A200639-1	E-Z200074-66
	BRN	E-Z1016-8369	A200639-1	E-Z200074-67
	ORG	E-Z1016-8365	A200639-1	E-Z200074-63
	YEL	E-Z1016-8363	A200639-1	E-Z200074-61

### Double Set Screw Non-Vulcanized Female Plugs

Cable Size	Color	Complete Part No.	Contact Only Part No.	Insulator Only Part No.
2/0-4/0	BK	E-Z1016-8387	A200641-1	E-Z200075-60
	RD	E-Z1016-8389	A200641-1	E-Z200075-62
	GR	E-Z1016-8391	A200641-1	E-Z200075-64
	WH	E-Z1016-8392	A200641-1	E-Z200075-65
	BU	E-Z1016-8393	A200641-1	E-Z200075-66
	BRN	E-Z1016-8394	A200641-1	E-Z200075-67
	ORG	E-Z1016-8390	A200641-1	E-Z200075-63
	YEL	E-Z1016-8388	A200641-1	E-Z200075-61

For E-Z1016 Elastomeric, Non-Vulcanized, Double Set Screw Connection, see Page F-50  
To order single packaged products add a "K" suffix to the complete part number

#### Color Information:

BK (Black), RD (Red), GR (Green), WH (White), BU (Blue), BRN (Brown), ORG (Orange), YEL (Yellow)



**Testing & Code Compliance:** Listed to UL498, file no. E67181, CSA Certified to C22.2, no. 182.3-M1987, file no. LR13963  
**Material Characteristics:** Insulator: TPE, Environmental: NEMA 3R, Temperature Rating: -40° C to 105° C

Specifications and availability are subject to change without notice.

**J-Series  
E-Z1016 Plugs**

Cable Size #2 - #1 AWG  
600V AC/DC, Up to 190A Continuous  
NEMA 3R



E-Z1016-8006



E-Z1016-8058

**J-Series E-Z1016, Elastomeric, Non-Vulcanized, Crimp Connection****Features**

- E-Z assembly and disassembly-no tools needed
- Double cam principle provides a positive, vibration-proof connection
- Self-compensating for wear
- No moving contact surfaces, eliminating arcing or burning
- Superior electro-mechanical connections
- Locked contacts will withstand a pulling force of 1,000 lbs
- 1/3 of a turn assures a high pressure contact approaching 600 lbs. per sq. in. providing minimum resistance
- Contacts carefully machined from a high conductivity brass to a smooth sliding fit and easy locking action
- Watertight elastomeric insulators molded from colorfast material, color-coded for easy phase identification
- Recessed contacts protected by insulating jacket that extends beyond contact ends for safety
- Integrated strain relief system features a retaining wire that prevents cable jacket pull-away and bare conductor exposure
- Plugs feature a high-strength, molded-in-place locking ring to capture and secure the insulator to the contact

**Crimp Non-Vulcanized Male Plugs**

Cable Size	Color	Complete Part No.	Contact Only Part No.	Insulator Only Part No.
#2-#1	BK	E-Z1016-8006	A200036-18	E-Z200074-19
	RD	E-Z1016-8008	A200036-18	E-Z200074-21
	GR	E-Z1016-8010	A200036-18	E-Z200074-23
	WH	E-Z1016-8011	A200036-18	E-Z200074-24
	BU	E-Z1016-7700	A200036-18	E-Z200074-38
	BRN	E-Z1016-7701	A200036-18	E-Z200074-47
	ORG	E-Z1016-8009	A200036-18	E-Z200074-22
	YEL	E-Z1016-8007	A200036-18	E-Z200074-20

**Crimp Non-Vulcanized Female Plugs**

Cable Size	Color	Complete Part No.	Contact Only Part No.	Insulator Only Part No.
#2-#1	BK	E-Z1016-8056	A200037-23	E-Z200075-19
	RD	E-Z1016-8058	A200037-23	E-Z200075-21
	GR	E-Z1016-8060	A200037-23	E-Z200075-23
	WH	E-Z1016-8061	A200037-23	E-Z200075-24
	BU	E-Z1016-7716	A200037-23	E-Z200075-44
	BRN	E-Z1016-7717	A200037-23	E-Z200075-52
	ORG	E-Z1016-8059	A200037-23	E-Z200075-22
	YEL	E-Z1016-8057	A200037-23	E-Z200075-20

For E-Z1016 Elastomeric, Non-Vulcanized, Crimp Connection, see Page F-50  
To order single packaged products add a "K" suffix to the complete part number

**Color Information:**

BK (Black), RD (Red), GR (Green), WH (White), BU (Blue), BRN (Brown), ORG (Orange), YEL (Yellow)



**Testing & Code Compliance:** Listed to UL498, file no. E67181, CSA Certified to C22.2, no. 182.3-M1987, file no. LR13963  
**Material Characteristics:** Insulator: TPE, Environmental: NEMA 3R, Temperature Rating: -40° C to 105° C

Specifications and availability are subject to change without notice.

## J-Series E-Z1016 Plugs

Cable Size 1/0 - 2/0  
600V AC/DC, Up to 300A Continuous  
NEMA 3R

### J-Series E-Z1016, Elastomeric, Non-Vulcanized, Crimp Connection

#### Features

- E-Z assembly and disassembly-no tools needed
- Double cam principle provides a positive, vibration-proof connection
- Self-compensating for wear
- No moving contact surfaces, eliminating arcing or burning
- Superior electro-mechanical connections
- Locked contacts will withstand a pulling force of 1,000 lbs
- 1/3 of a turn assures a high pressure contact approaching 600 lbs. per sq. in. providing minimum resistance
- Contacts carefully machined from a high conductivity copper alloy to a smooth sliding fit and easy locking action
- Watertight elastomeric insulators molded from colorfast material, color-coded for easy phase identification
- Recessed contacts protected by insulating jacket that extends beyond contact ends for safety
- Integrated strain relief system features a retaining wire that prevents cable jacket pull-away and bare conductor exposure
- Plugs feature a high-strength, molded-in-place locking ring to capture and secure the insulator to the contact



E-Z1016-8021



E-Z1016-8073

### Crimp Non-Vulcanized Male Plugs

Cable Size	Color	Complete Part No.	Contact Only Part No.	Insulator Only Part No.
1/0-2/0	BK	E-Z1016-8018	A200038-11	E-Z200074-60
	RD	E-Z1016-8020	A200038-11	E-Z200074-62
	GR	E-Z1016-8022	A200038-11	E-Z200074-64
	WH	E-Z1016-8023	A200038-11	E-Z200074-65
	BU	E-Z1016-7704	A200038-11	E-Z200074-66
	BRN	E-Z1016-7705	A200038-11	E-Z200074-67
	ORG	E-Z1016-8021	A200038-11	E-Z200074-63
	YEL	E-Z1016-8019	A200038-11	E-Z200074-61

### Crimp Non-Vulcanized Female Plugs

Cable Size	Color	Complete Part No.	Contact Only Part No.	Insulator Only Part No.
1/0-2/0	BK	E-Z1016-8068	A200035-17	E-Z200075-60
	RD	E-Z1016-8070	A200035-17	E-Z200075-62
	GR	E-Z1016-8072	A200035-17	E-Z200075-64
	WH	E-Z1016-8073	A200035-17	E-Z200075-65
	BU	E-Z1016-7720	A200035-17	E-Z200075-66
	BRN	E-Z1016-7721	A200035-17	E-Z200075-67
	ORG	E-Z1016-8071	A200035-17	E-Z200075-63
	YEL	E-Z1016-8069	A200035-17	E-Z200075-61

For E-Z1016 Elastomeric, Non-Vulcanized, Crimp Connection, see Page F-50  
To order single packaged products add a "K" suffix to the complete part number

#### Color Information:

BK (Black), RD (Red), GR (Green), WH (White), BU (Blue), BRN (Brown), ORG (Orange), YEL (Yellow)



**Testing & Code Compliance:** Listed to UL498, file no. E67181, CSA Certified to C22.2, no. 182.3-M1987, file no. LR13963  
**Material Characteristics:** Contact: Copper (CU), Insulator: TPE, Environmental: NEMA 3R, Temperature Rating: -40° C to 105° C  
**Specifications and availability are subject to change without notice.**



## J-Series E-Z1016 Plugs

Cable Size 3/0 – 4/0  
600V AC/DC, Up to 400A Continuous  
NEMA 3R



E-Z1016-8031



E-Z1016-7724

### J-Series E-Z1016, Elastomeric, Non-Vulcanized, Crimp Connection

#### Features

- E-Z assembly and disassembly-no tools needed
- Double cam principle provides a positive, vibration-proof connection
- Self-compensating for wear
- No moving contact surfaces, eliminating arcing or burning
- Superior electro-mechanical connections
- Locked contacts will withstand a pulling force of 1,000 lbs
- 1/3 of a turn assures a high pressure contact approaching 600 lbs. per sq. in. providing minimum resistance
- Contacts carefully machined from a high conductivity copper alloy to a smooth sliding fit and easy locking action
- Watertight elastomeric insulators molded from colorfast material, color-coded for easy phase identification
- Recessed contacts protected by insulating jacket that extends beyond contact ends for safety
- Integrated strain relief system features a retaining wire that prevents cable jacket pull-away and bare conductor exposure
- Plugs feature a high-strength, molded-in-place locking ring to capture and secure the insulator to the contact

### Crimp Non-Vulcanized Male Plugs

Cable Size	Color	Complete Part No.	Contact Only Part No.	Insulator Only Part No.
3/0-4/0	BK	E-Z1016-8030	A200038-6	E-Z200074-60
	RD	E-Z1016-8032	A200038-6	E-Z200074-62
	GR	E-Z1016-8034	A200038-6	E-Z200074-64
	WH	E-Z1016-8035	A200038-6	E-Z200074-65
	BU	E-Z1016-7708	A200038-6	E-Z200074-66
	BRN	E-Z1016-7709	A200038-6	E-Z200074-67
	ORG	E-Z1016-8033	A200038-6	E-Z200074-63
	YEL	E-Z1016-8031	A200038-6	E-Z200074-61

### Crimp Non-Vulcanized Female Plugs

Cable Size	Color	Complete Part No.	Contact Only Part No.	Insulator Only Part No.
3/0-4/0	BK	E-Z1016-8080	A200035-14	E-Z200075-60
	RD	E-Z1016-8082	A200035-14	E-Z200075-62
	GR	E-Z1016-8084	A200035-14	E-Z200075-64
	WH	E-Z1016-8085	A200035-14	E-Z200075-65
	BU	E-Z1016-7724	A200035-14	E-Z200075-66
	BRN	E-Z1016-7725	A200035-14	E-Z200075-67
	ORG	E-Z1016-8083	A200035-14	E-Z200075-63
	YEL	E-Z1016-8081	A200035-14	E-Z200075-61

For E-Z1016 Elastomeric, Non-Vulcanized, Crimp Connection, see Page F-50  
To order single packaged products add a "K" suffix to the complete part number

#### Color Information:

BK (Black), RD (Red), GR (Green), WH (White), BU (Blue), BRN (Brown), ORG (Orange), YEL (Yellow)



**Testing & Code Compliance:** Listed to UL498, file no. E67181, CSA Certified to C22.2, no. 182.3-M1987, file no. LR13963  
**Material Characteristics:** Contact: Copper (CU), Insulator: TPE, Environmental: NEMA 3R, Temperature Rating: -40° C to 105° C  
**Specifications and availability are subject to change without notice.**

**J-Series  
E1016 Plugs** | Cable Size #2 AWG – 2/0  
600V AC/DC, Up to 300A Continuous  
NEMA 3R

**J-Series E1016, Elastomeric, Non-Vulcanized, Double Set Screw Connection**

**Features**

- Double cam principle provides a positive, vibration-proof connection
- Self-compensating for wear
- No moving contact surfaces, eliminating arcing or burning
- Superior electro-mechanical connections
- Locked contacts will withstand a pulling force of 1,000 lbs
- 1/3 of a turn assures a high pressure contact approaching 600 lbs. per sq. in. providing minimum resistance
- Accepts a wide range of cable sizes
- Contacts carefully machined from a high conductivity brass to a smooth sliding fit and easy locking action
- Watertight elastomeric insulators molded from colorfast material, color-coded for easy phase identification
- Recessed contacts protected by insulating jacket that extends beyond contact ends for safety
- Integrated strain relief system features a retaining wire that prevents cable jacket pull-away and bare conductor exposure
- Plugs feature a high-strength, molded-in-place locking ring to capture and secure the insulator to the contact



E1016-8354



E1016-8380

**Double Set Screw Non-Vulcanized Male Plugs**

Cable Size	Color	Complete Part No.	Contact Only Part No.	Insulator Only Part No.
#2-2/0	BK	E1016-8350	A200630-1	A200074-19
	RD	E1016-8352	A200630-1	A200074-21
	GR	E1016-8354	A200630-1	A200074-23
	WH	E1016-8355	A200630-1	A200074-24
	BU	E1016-8356	A200630-1	A200074-38
	BRN	E1016-8357	A200630-1	A200074-47
	ORG	E1016-8353	A200630-1	A200074-22
	YEL	E1016-8351	A200630-1	A200074-20

**Double Set Screw Non-Vulcanized Female Plugs**

Cable Size	Color	Complete Part No.	Contact Only Part No.	Insulator Only Part No.
#2-2/0	BK	E1016-8375	A200640-3	A200075-19
	RD	E1016-8377	A200640-3	A200075-21
	GR	E1016-8379	A200640-3	A200075-23
	WH	E1016-8380	A200640-3	A200075-24
	BU	E1016-8381	A200640-3	A200075-44
	BRN	E1016-8382	A200640-3	A200075-52
	ORG	E1016-8378	A200640-3	A200075-22
	YEL	E1016-8376	A200640-3	A200075-20

For E1016 Elastomeric, Non-Vulcanized, Double Set Screw Connection, see Page F-51  
To order single packaged products add a "K" suffix to the complete part number

**Color Information:**

BK (Black), RD (Red), GR (Green), WH (White), BU (Blue), BRN (Brown), ORG (Orange), YEL (Yellow)



**Testing & Code Compliance:** Listed to UL498, file no. E67181, CSA Certified to C22.2, no. 182.3-M1987, file no. LR13963  
**Material Characteristics:** Insulator: TPE, Environmental: NEMA 3R, Temperature Rating: -40° C to 105° C

Specifications and availability are subject to change without notice.

**J-Series  
E1016 Plugs**

Cable Size 2/0 – 4/0  
600V AC/DC, Up to 400A Continuous  
NEMA 3R



E1016-8367



E1016-8393

**J-Series E1016, Elastomeric, Non-Vulcanized, Double Set Screw Connection****Features**

- Double cam principle provides a positive, vibration-proof connection
- Self-compensating for wear
- No moving contact surfaces, eliminating arcing or burning
- Superior electro-mechanical connections
- 400A continuous duty rating when used with 90°C 4/0 cable
- Locked contacts will withstand a pulling force of 1,000 lbs
- 1/3 of a turn assures a high pressure contact approaching 600 lbs. per sq. in. providing minimum resistance
- Accepts a wide range of cable sizes
- Contacts carefully machined from a high conductivity brass to a smooth sliding fit and easy locking action
- Watertight elastomeric insulators molded from colorfast material, color-coded for easy phase identification
- Recessed contacts protected by insulating jacket that extends beyond contact ends for safety
- Integrated strain relief system features a retaining wire that prevents cable jacket pull-away and bare conductor exposure
- Plugs feature a high-strength, molded-in-place locking ring to capture and secure the insulator to the contact

**Double Set Screw Non-Vulcanized Male Plugs**

Cable Size	Color	Complete Part No.	Contact Only Part No.	Insulator Only Part No.
2/0-4/0	BK	E1016-8362	A200639-1	A200074-60
	RD	E1016-8364	A200639-1	A200074-62
	GR	E1016-8366	A200639-1	A200074-64
	WH	E1016-8367	A200639-1	A200074-65
	BU	E1016-8368	A200639-1	A200074-66
	BRN	E1016-8369	A200639-1	A200074-67
	ORG	E1016-8365	A200639-1	A200074-63
	YEL	E1016-8363	A200639-1	A200074-61

**Double Set Screw Non-Vulcanized Female Plugs**

Cable Size	Color	Complete Part No.	Contact Only Part No.	Insulator Only Part No.
2/0-4/0	BK	E1016-8387	A200641-1	A200075-60
	RD	E1016-8389	A200641-1	A200075-62
	GR	E1016-8391	A200641-1	A200075-64
	WH	E1016-8392	A200641-1	A200075-65
	BU	E1016-8393	A200641-1	A200075-66
	BRN	E1016-8394	A200641-1	A200075-67
	ORG	E1016-8390	A200641-1	A200075-63
	YEL	E1016-8388	A200641-1	A200075-61

For E1016 Elastomeric, Non-Vulcanized, Double Set Screw Connection, see Page F-51  
To order single packaged products add a "K" suffix to the complete part number

**Color Information:**

BK (Black), RD (Red), GR (Green), WH (White), BU (Blue), BRN (Brown), ORG (Orange), YEL (Yellow)



**Testing & Code Compliance:** Listed to UL498, file no. E67181, CSA Certified to C22.2, no. 182.3-M1987, file no. LR13963  
**Material Characteristics:** Insulator: TPE, Environmental: NEMA 3R, Temperature Rating: -40° C to 105° C

**Specifications and availability are subject to change without notice.**

**J-Series  
E1016 Plugs**

Cable Size #2 – #1 AWG  
600V AC/DC, Up to 190A Continuous  
NEMA 3R

**J-Series E1016, Elastomeric, Non-Vulcanized, Crimp Connection**

**Features**

- Double cam principle provides a positive, vibration-proof connection
- Self-compensating for wear
- No moving contact surfaces, eliminating arcing or burning
- Superior electro-mechanical connections
- Locked contacts will withstand a pulling force of 1,000 lbs
- 1/3 of a turn assures a high pressure contact approaching 600 lbs. per sq. in. providing minimum resistance
- Contacts carefully machined from a high conductivity brass to a smooth sliding fit and easy locking action
- Watertight elastomeric insulators molded from colorfast material, color-coded for easy phase identification
- Recessed contacts protected by insulating jacket that extends beyond contact ends for safety
- Integrated strain relief system features a retaining wire that prevents cable jacket pull-away and bare conductor exposure
- Plugs feature a high-strength, molded-in-place locking ring to capture and secure the insulator to the contact



E1016-8006



E1016-8058

**Crimp Non-Vulcanized Male Plugs**

Cable Size	Color	Complete Part No.	Contact Only Part No.	Insulator Only Part No.
#2-#1	BK	E1016-8006	A200036-18	A200074-19
	RD	E1016-8008	A200036-18	A200074-21
	GR	E1016-8010	A200036-18	A200074-23
	WH	E1016-8011	A200036-18	A200074-24
	BU	E1016-7700	A200036-18	A200074-38
	BRN	E1016-7701	A200036-18	A200074-47
	ORG	E1016-8009	A200036-18	A200074-22
	YEL	E1016-8007	A200036-18	A200074-20

**Crimp Non-Vulcanized Female Plugs**

Cable Size	Color	Complete Part No.	Contact Only Part No.	Insulator Only Part No.
#2-#1	BK	E1016-8056	A200037-23	A200075-19
	RD	E1016-8058	A200037-23	A200075-21
	GR	E1016-8060	A200037-23	A200075-23
	WH	E1016-8061	A200037-23	A200075-24
	BU	E1016-7716	A200037-23	A200075-44
	BRN	E1016-7717	A200037-23	A200075-52
	ORG	E1016-8059	A200037-23	A200075-22
	YEL	E1016-8057	A200037-23	A200075-20

For E1016 Elastomeric, Non-Vulcanized, Crimp Connection, see Page F-51  
To order single packaged products add a "K" suffix to the complete part number

**Color Information:**

BK (Black), RD (Red), GR (Green), WH (White), BU (Blue), BRN (Brown), ORG (Orange), YEL (Yellow)



**Testing & Code Compliance:** Listed to UL498, file no. E67181, CSA Certified to C22.2, no. 182.3-M1987, file no. LR13963  
**Material Characteristics:** Insulator: TPE, Environmental: NEMA 3R, Temperature Rating: -40° C to 105° C

Specifications and availability are subject to change without notice.

**J-Series  
E1016 Plugs**

Cable Size 1/0 – 2/0  
600V AC/DC, Up to 235A Continuous  
NEMA 3R



E1016-8020



E1016-8069

**J-Series E1016, Elastomeric, Non-Vulcanized, Crimp Connection****Features**

- Double cam principle provides a positive, vibration-proof connection
- Self-compensating for wear
- No moving contact surfaces, eliminating arcing or burning
- Superior electro-mechanical connections
- Locked contacts will withstand a pulling force of 1,000 lbs
- 1/3 of a turn assures a high pressure contact approaching 600 lbs. per sq. in. providing minimum resistance
- Contacts carefully machined from a high conductivity brass to a smooth sliding fit and easy locking action
- Watertight elastomeric insulators molded from colorfast material, color-coded for easy phase identification
- Recessed contacts protected by insulating jacket that extends beyond contact ends for safety
- Integrated strain relief system features a retaining wire that prevents cable jacket pull-away and bare conductor exposure
- Plugs feature a high-strength, molded-in-place locking ring to capture and secure the insulator to the contact

**Crimp Non-Vulcanized Male Plugs**

Cable Size	Color	Complete Part No.	Contact Only Part No.	Insulator Only Part No.
1/0-2/0	BK	E1016-8018	A200038-11B	A200074-13
	RD	E1016-8020	A200038-11B	A200074-15
	GR	E1016-8022	A200038-11B	A200074-17
	WH	E1016-8023	A200038-11B	A200074-18
	BU	E1016-7704	A200038-11B	A200074-37
	BRN	E1016-7705	A200038-11B	A200074-46
	ORG	E1016-8021	A200038-11B	A200074-16
	YEL	E1016-8019	A200038-11B	A200074-14

**Crimp Non-Vulcanized Female Plugs**

Cable Size	Color	Complete Part No.	Contact Only Part No.	Insulator Only Part No.
1/0-2/0	BK	E1016-8068	A200035-17B	A200075-13
	RD	E1016-8070	A200035-17B	A200075-15
	GR	E1016-8072	A200035-17B	A200075-17
	WH	E1016-8073	A200035-17B	A200075-18
	BU	E1016-7720	A200035-17B	A200075-37
	BRN	E1016-7721	A200035-17B	A200075-51
	ORG	E1016-8071	A200035-17B	A200075-16
	YEL	E1016-8069	A200035-17B	A200075-14

For E1016 Elastomeric, Non-Vulcanized, Crimp Connection, see Page F-51  
To order single packaged products add a "K" suffix to the complete part number

**Color Information:**

BK (Black), RD (Red), GR (Green), WH (White), BU (Blue), BRN (Brown), ORG (Orange), YEL (Yellow)



**Testing & Code Compliance:** Listed to UL498, file no. E67181, CSA Certified to C22.2, no. 182.3-M1987, file no. LR13963  
**Material Characteristics:** Insulator: TPE, Environmental: NEMA 3R, Temperature Rating: -40° C to 105° C

Specifications and availability are subject to change without notice.

**J-Series  
E1016 Plugs**

Cable Size 3/0 – 4/0  
600V AC/DC, Up to 315A Continuous  
NEMA 3R

**J-Series E1016, Elastomeric, Non-Vulcanized, Crimp Connection**

**Features**

- Double cam principle provides a positive, vibration-proof connection
- Self-compensating for wear
- No moving contact surfaces, eliminating arcing or burning
- Superior electro-mechanical connections
- Locked contacts will withstand a pulling force of 1,000 lbs
- 1/3 of a turn assures a high pressure contact approaching 600 lbs. per sq. in. providing minimum resistance
- Contacts carefully machined from a high conductivity brass to a smooth sliding fit and easy locking action
- Watertight elastomeric insulators molded from colorfast material, color-coded for easy phase identification
- Recessed contacts protected by insulating jacket that extends beyond contact ends for safety
- Integrated strain relief system features a retaining wire that prevents cable jacket pull-away and bare conductor exposure
- Plugs feature a high-strength, molded-in-place locking ring to capture and secure the insulator to the contact



E1016-8035



E1016-7724

**Crimp Non-Vulcanized Male Plugs**

Cable Size	Color	Complete Part No.	Contact Only Part No.	Insulator Only Part No.
3/0-4/0	BK	E1016-8030	A200038-6B	A200074-13
	RD	E1016-8032	A200038-6B	A200074-15
	GR	E1016-8034	A200038-6B	A200074-17
	WH	E1016-8035	A200038-6B	A200074-18
	BU	E1016-7708	A200038-6B	A200074-37
	BRN	E1016-7709	A200038-6B	A200074-46
	ORG	E1016-8033	A200038-6B	A200074-16
	YEL	E1016-8031	A200038-6B	A200074-14

**Crimp Non-Vulcanized Female Plugs**

Cable Size	Color	Complete Part No.	Contact Only Part No.	Insulator Only Part No.
3/0-4/0	BK	E1016-8080	A200035-14B	A200075-13
	RD	E1016-8082	A200035-14B	A200075-15
	GR	E1016-8084	A200035-14B	A200075-17
	WH	E1016-8085	A200035-14B	A200075-18
	BU	E1016-7724	A200035-14B	A200075-37
	BRN	E1016-7725	A200035-14B	A200075-51
	ORG	E1016-8083	A200035-14B	A200075-16
	YEL	E1016-8081	A200035-14B	A200075-14

For E1016 Elastomeric, Non-Vulcanized, Crimp Connection, see Page F-51  
To order single packaged products add a "K" suffix to the complete part number

**Color Information:**

BK (Black), RD (Red), GR (Green), WH (White), BU (Blue), BRN (Brown), ORG (Orange), YEL (Yellow)



**Testing & Code Compliance:** Listed to UL498, file no. E67181, CSA Certified to C22.2, no. 182.3-M1987, file no. LR13963  
**Material Characteristics:** Insulator: TPE, Environmental: NEMA 3R, Temperature Rating: -40° C to 105° C

Specifications and availability are subject to change without notice.

**J-Series  
E1016 Plugs**

Cable Size #2 – #1 AWG  
600V AC/DC, Up to 190A Continuous  
NEMA 4



E1016-7



E1016-58

**J-Series E1016, Rubber, Vulcanized, Crimp Connection****Features**

- Vulcanizing permanently affixes plug insulator to cable for maximum protection against water, all kinds of weather, corrosion and other contaminants (requires vulcanizing kit/presses)
- Vulcanizing also reduces cable breakage by distributing flexing over a wide area for an effective strain relief system
- Double cam principle provides a positive, vibration-proof connection
- Self-compensating for wear
- No moving contact surfaces, eliminating arcing or burning
- Superior electro-mechanical connections
- Locked contacts will withstand a pulling force of 1,000 lbs
- 1/3 of a turn assures a high pressure contact approaching 600 lbs. per sq. in. providing minimum resistance
- Contacts carefully machined from a high conductivity brass to a smooth sliding fit and easy locking action
- Watertight neoprene insulators molded from colorfast material, color-coded for easy phase identification
- Recessed contacts protected by insulating jacket that extends beyond contact ends for safety

**Crimp Vulcanized Male Plugs**

Cable Size	Color	Complete Part No.	Contact Only Part No.	Insulator Only Part No.
#2-#1	BK	E1016-7	A200036-2	A200706-7
	RD	E1016-9	A200036-2	A200706-9
	GR	E1016-11	A200036-2	A200706-11
	WH	E1016-12	A200036-2	A200706-12
	BU	E1016-46	A200036-2	A200706-97
	BRN	E1016-118	A200036-2	A200706-101
	ORG	E1016-10	A200036-2	A200706-10
	YEL	E1016-8	A200036-2	A200706-8

**Crimp Vulcanized Female Plugs**

Cable Size	Color	Complete Part No.	Contact Only Part No.	Insulator Only Part No.
#2-#1	BK	E1016-56	A200037-2	A200705-7
	RD	E1016-58	A200037-2	A200705-9
	GR	E1016-60	A200037-2	A200705-11
	WH	E1016-61	A200037-2	A200705-12
	BU	E1016-95	A200037-2	A200705-64
	BRN	E1016-119	A200037-2	A200705-101
	ORG	E1016-59	A200037-2	A200705-10
	YEL	E1016-57	A200037-2	A200705-8

For E1016 Rubber, Vulcanized, Crimp Connection, see Page F-51  
To order single packaged products add a "K" suffix to the complete part number

**Color Information:**

BK (Black), RD (Red), GR (Green), WH (White), BU (Blue), BRN (Brown), ORG (Orange), YEL (Yellow)



**Testing & Code Compliance:** Listed to UL498, file no. E67181, CSA Certified to C22.2, no. 182.3-M1987, file no. LR13963  
**Material Characteristics:** Insulator: Rubber, Environmental: NEMA 4, Temperature Rating: -40° C to 105° C

Specifications and availability are subject to change without notice.

**J-Series  
E1016 Plugs** | Cable Size 1/0 – 2/0  
600V AC/DC, Up to 235A Continuous  
NEMA 4

**J-Series E1016, Rubber, Vulcanized, Crimp Connection**

**Features**

- Vulcanizing permanently affixes plug insulator to cable for maximum protection against water, all kinds of weather, corrosion and other contaminants (requires vulcanizing kit/presses)
- Vulcanizing also reduces cable breakage by distributing flexing over a wide area for an effective strain relief system
- Double cam principle provides a positive, vibration-proof connection
- Self-compensating for wear
- No moving contact surfaces, eliminating arcing or burning
- Superior electro-mechanical connections
- Locked contacts will withstand a pulling force of 1,000 lbs
- 1/3 of a turn assures a high pressure contact approaching 600 lbs. per sq. in. providing minimum resistance
- Contacts carefully machined from a high conductivity brass to a smooth sliding fit and easy locking action
- Watertight neoprene insulators molded from colorfast material, color-coded for easy phase identification
- Recessed contacts protected by insulating jacket that extends beyond contact ends for safety



E1016-120



E1016-66

**Crimp Vulcanized Male Plugs**

Cable Size	Color	Complete Part No.	Contact Only Part No.	Insulator Only Part No.
1/0-2/0	BK	E1016-13	A200036-3	A200706-7
	RD	E1016-15	A200036-3	A200706-9
	GR	E1016-17	A200036-3	A200706-11
	WH	E1016-18	A200036-3	A200706-12
	BU	E1016-43	A200036-3	A200706-97
	BRN	E1016-120	A200036-3	A200706-101
	ORG	E1016-16	A200036-3	A200706-10
	YEL	E1016-14	A200036-3	A200706-8

**Crimp Vulcanized Female Plugs**

Cable Size	Color	Complete Part No.	Contact Only Part No.	Insulator Only Part No.
1/0-2/0	BK	E1016-62	A200037-3	A200705-7
	RD	E1016-64	A200037-3	A200705-9
	GR	E1016-66	A200037-3	A200705-11
	WH	E1016-67	A200037-3	A200705-12
	BU	E1016-92	A200037-3	A200705-64
	BRN	E1016-121	A200037-3	A200705-101
	ORG	E1016-65	A200037-3	A200705-10
	YEL	E1016-63	A200037-3	A200705-8

For E1016 Rubber, Vulcanized, Crimp Connection, see Page F-51  
To order single packaged products add a "K" suffix to the complete part number

**Color Information:**

BK (Black), RD (Red), GR (Green), WH (White), BU (Blue), BRN (Brown), ORG (Orange), YEL (Yellow)



**Testing & Code Compliance:** Listed to UL498, file no. E67181, CSA Certified to C22.2, no. 182.3-M1987, file no. LR13963  
**Material Characteristics:** Insulator: Rubber, Environmental: NEMA 4, Temperature Rating: -40° C to 105° C

Specifications and availability are subject to change without notice.



**J-Series  
E1016 Plugs**

Cable Size 3/0 – 4/0  
600V AC/DC, Up to 315A Continuous  
NEMA 4



E1016-45



E1016-86

**J-Series E1016, Rubber, Vulcanized, Crimp Connection****Features**

- Vulcanizing permanently affixes plug insulator to cable for maximum protection against water, all kinds of weather, corrosion and other contaminants (requires vulcanizing kit/presses)
- Vulcanizing also reduces cable breakage by distributing flexing over a wide area for an effective strain relief system
- Double cam principle provides a positive, vibration-proof connection
- Self-compensating for wear
- No moving contact surfaces, eliminating arcing or burning
- Superior electro-mechanical connections
- Locked contacts will withstand a pulling force of 1,000 lbs
- 1/3 of a turn assures a high pressure contact approaching 600 lbs. per sq. in. providing minimum resistance
- Contacts carefully machined from a high conductivity brass to a smooth sliding fit and easy locking action
- Watertight neoprene insulators molded from colorfast material, color-coded for easy phase identification
- Recessed contacts protected by insulating jacket that extends beyond contact ends for safety

**Crimp Vulcanized Male Plugs**

Cable Size	Color	Complete Part No.	Contact Only Part No.	Insulator Only Part No.
3/0-4/0	BK	E1016-31	A200038-2	A200706-13
	RD	E1016-33	A200038-2	A200706-15
	GR	E1016-35	A200038-2	A200706-17
	WH	E1016-36	A200038-2	A200706-18
	BU	E1016-45	A200038-2	A200706-64
	BRN	E1016-465	A200038-2	A200706-19
	ORG	E1016-34	A200038-2	A200706-16
	YEL	E1016-32	A200038-2	A200706-14

**Crimp Vulcanized Female Plugs**

Cable Size	Color	Complete Part No.	Contact Only Part No.	Insulator Only Part No.
3/0-4/0	BK	E1016-80	A200035-2	A200705-13
	RD	E1016-82	A200035-2	A200705-15
	GR	E1016-84	A200035-2	A200705-17
	WH	E1016-85	A200035-2	A200705-18
	BU	E1016-94	A200035-2	A200705-65
	BRN	E1016-98	A200035-2	A200705-19
	ORG	E1016-83	A200035-2	A200705-16
	YEL	E1016-81	A200035-2	A200705-14

For E1016 Rubber, Vulcanized, Crimp Connection, see Page F-51  
To order single packaged products add a "K" suffix to the complete part number

**Color Information:**

BK (Black), RD (Red), GR (Green), WH (White), BU (Blue), BRN (Brown), ORG (Orange), YEL (Yellow)



**Testing & Code Compliance:** Listed to UL498, file no. E67181, CSA Certified to C22.2, no. 182.3-M1987, file no. LR13963  
**Material Characteristics:** Insulator: Rubber, Environmental: NEMA 4, Temperature Rating: -40° C to 105° C

Specifications and availability are subject to change without notice.

## J-Series E1016 Receptacles

Cable Size #6 AWG – 250 MCM  
600V AC/DC, Up to 400A Continuous  
NEMA 3R

### J-Series E1016, Elastomeric, Threaded Stud

#### Features

- Double cam principle provides a positive, vibration-proof connection
- Self-compensating for wear
- No moving contact surfaces, eliminating arcing or burning
- Superior electro-mechanical connections.
- Locked contacts will withstand a pulling force of 1,000 lbs
- 1/3 of a turn assures a high pressure contact approaching 600 lbs. per sq. in. providing minimum resistance
- Contacts carefully machined from a high conductivity brass to a smooth sliding fit and easy locking action
- Watertight elastomeric body molded from colorfast material, color-coded for easy phase identification
- Recessed contacts protected by insulating jacket that extends beyond contact ends for safety.
- Receptacles are safety insulated for direct mounting to steel panels.

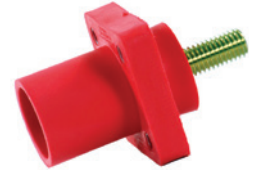

E1016-1602S 1 1/8"



E1016-1600 3/4"

### Insulated Receptacles - 1 1/8" Threaded Stud

Color	Male Complete Part No.	Female Complete Part No.
BK	E1016-1600S	E1016-1631S
RD	E1016-1602S	E1016-1633S
GR	E1016-1604S	E1016-1635S
WH	E1016-1605S	E1016-1636S
BU	E1016-1612S	E1016-1643S
BRN	E1016-1619S	E1016-1687S
ORG	E1016-1603S	E1016-1634S
YEL	E1016-1601S	E1016-1632S

Stud Size: 1/2"-13, Maximum Torque: 40 ft. lbs.

### Insulated Receptacles - 3/4" Threaded Stud

Color	Male Complete Part No.	Female Complete Part No.
BK	E1016-1600	E1016-1631
RD	E1016-1602	E1016-1633
GR	E1016-1604	E1016-1635
WH	E1016-1605	E1016-1636
BU	E1016-1612	E1016-1643
BRN	E1016-1619	E1016-1687
ORG	E1016-1603	E1016-1634
YEL	E1016-1601	E1016-1632

Stud Size: 1/2"-13, Maximum Torque: 40 ft. lbs.

For E1016 Threaded Stud Receptacle Drawings, see Page 37

To order single packaged products add a "K" suffix to the complete part number

#### Color Information:

BK (Black), RD (Red), GR (Green), WH (White), BU (Blue), BRN (Brown), ORG (Orange), YEL (Yellow)

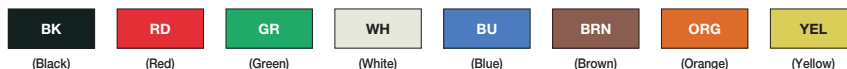

**Testing & Code Compliance:** Listed to UL498, file no. E67181, CSA Certified to C22.2, no. 182.3-M1987, file no. LR13963

**Material Characteristics:** Body: TPE, Environmental: NEMA 3R, Temperature Rating: -40° C to 105° C

Specifications and availability are subject to change without notice.

**J-Series  
E1016 Receptacles**

Cable Size #2 AWG – 4/0  
600V AC/DC, Up to 400A Continuous  
NEMA 3R



E1016-1700B



E1016-1704BB

**J-Series E1016, Elastomeric, Busbar****Features**

- Double cam principle provides a positive, vibration-proof connection
- Self-compensating for wear
- No moving contact surfaces, eliminating arcing or burning
- Superior electro-mechanical connections
- Locked contacts will withstand a pulling force of 1,000 lbs
- 1/3 of a turn assures a high pressure contact approaching 600 lbs. per sq. in. providing minimum resistance
- Contacts carefully machined from a high conductivity brass to a smooth sliding fit and easy locking action
- Watertight elastomeric body molded from colorfast material, color-coded for easy phase identification
- Recessed contacts protected by insulating jacket that extends beyond contact ends for safety
- Receptacles are safety insulated for direct mounting to steel panels

**Insulated Receptacles Single Hole Busbar**

	Color	Male Complete Part No.	Female Complete Part No.
Single Hole Busbar	BK	E1016-1700B	E1016-1725B
	RD	E1016-1702B	E1016-1727B
	GR	E1016-1704B	E1016-1729B
	WH	E1016-1705B	E1016-1730B
	BU	E1016-1706B	E1016-1731B
	BRN	E1016-1707B	E1016-1732B
	ORG	E1016-1703B	E1016-1728B
	YEL	E1016-1701B	E1016-1726B

**Insulated Receptacles Double Hole Busbar**

	Color	Male Complete Part No.	Female Complete Part No.
Double Hole Busbar	BK	E1016-1700BB	E1016-1725BB
	RD	E1016-1702BB	E1016-1727BB
	GR	E1016-1704BB	E1016-1729BB
	WH	E1016-1705BB	E1016-1730BB
	BU	E1016-1706BB	E1016-1731BB
	BRN	E1016-1707BB	E1016-1732BB
	ORG	E1016-1703BB	E1016-1728BB
	YEL	E1016-1701BB	E1016-1726BB

For E1016 Busbar Receptacle Drawings, see Page 37  
To order single packaged products add a "K" suffix to the complete part number

**Color Information:**

BK (Black), RD (Red), GR (Green), WH (White), BU (Blue), BRN (Brown), ORG (Orange), YEL (Yellow)



**Testing & Code Compliance:** Listed to UL498, file no. E67181, CSA Certified to C22.2, no. 182.3-M1987, file no. LR13963  
**Material Characteristics:** Body: TPE, Environmental: NEMA 3R, Temperature Rating: -40° C to 105° C

Specifications and availability are subject to change without notice.

## J-Series E1016 Receptacles

Cable Size #2 AWG – 4/0  
600V AC/DC, Up to 400A Continuous  
480V AC/DC, Up to 315A Continuous  
NEMA 3R

### J-Series E1016, Elastomeric - Double Set Screw/Inter-Lock Switch

#### Features

- Double cam principle provides a positive, vibration-proof connection
- Self-compensating for wear
- No moving contact surfaces, eliminating arcing or burning
- Superior electro-mechanical connections
- Locked contacts will withstand a pulling force of 1,000 lbs
- 1/3 of a turn assures a high pressure contact approaching 600 lbs. per sq. in. providing minimum resistance
- Contacts carefully machined from a high conductivity brass to a smooth sliding fit and easy locking action
- Watertight elastomeric body molded from colorfast material, color-coded for easy phase identification
- Recessed contacts protected by insulating jacket that extends beyond contact ends for safety
- Receptacles are safety insulated for direct mounting to steel panels

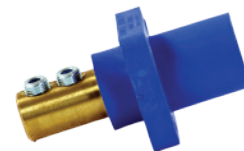

E1016-1706

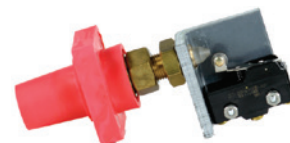

E1016-2269

### Insulated Receptacles Double Set Screw

Tightening Torque		Color	Male Complete Part No.	Female Complete Part No.
Cable	Torque (In lbs)	BK	E1016-1700	E1016-1725
#2-#1	100	RD	E1016-1702	E1016-1727
1/0-2/0	120	GR	E1016-1704	E1016-1729
3/0-4/0	220	WH	E1016-1705	E1016-1730
600 Volts		BU	E1016-1706	E1016-1731
400 Amps		BRN	E1016-1707	E1016-1732
		ORG	E1016-1703	E1016-1728
		YEL	E1016-1701	E1016-1726

For E1016 Double Set Screw Receptacle Drawings, see Page 37

### Insulated Receptacles with Inter-Lock Switch (Not UL Listed or CSA Certified)

	Color	Female Complete Part No.
Female Receptacles With Inter-Lock Switch	BK	E1016-2267
	RD	E1016-2269
480 Volts	GR	E1016-2271
315 Amps	WH	E1016-2272
	BU	E1016-2294
	BRN	E1016-2295
	ORG	E1016-2270
	YEL	E1016-2268

For E1016 Insulated Receptacle with Inter-Lock Switch Drawings, see Page F-51  
To order single packaged products add a "K" suffix to the complete part number

#### Color Information:

BK (Black), RD (Red), GR (Green), WH (White), BU (Blue), BRN (Brown), ORG (Orange), YEL (Yellow)



**Testing & Code Compliance:** Listed to UL498, file no. E67181, CSA Certified to C22.2, no. 182.3-M1987, file no. LR13963  
**Material Characteristics:** Body: TPE, Environmental: NEMA 3R, Temperature Rating: -40° C to 105° C

Specifications and availability are subject to change without notice.

## Receptacles Covers | NEMA 3R

**J-Series E1015/E1016, NEMA 3R Receptacle Covers****Features**

- Molded from colorfast material color-coded for easy phase identification
- High impact resistant thermoplastic covers and bodies
- Mounts directly to new or existing receptacles
- Stainless steel hardware
- Provides NEMA 3R protection
- Complete color offering

**NEMA 3R Receptacle Covers**

Color	E1015-Series	E1016-Series
BK	E1015SC-32	E1016SC-32
RD	E1015SC-36	E1016SC-36
GR	E1015SC-35	E1016SC-35
WH	E1015SC-38	E1016SC-38
BU	E1015SC-34	E1016SC-34
BRN	E1015SC-31	E1016SC-31
ORG	E1015SC-39	E1016SC-39
YEL	E1015SC-37	E1016SC-37

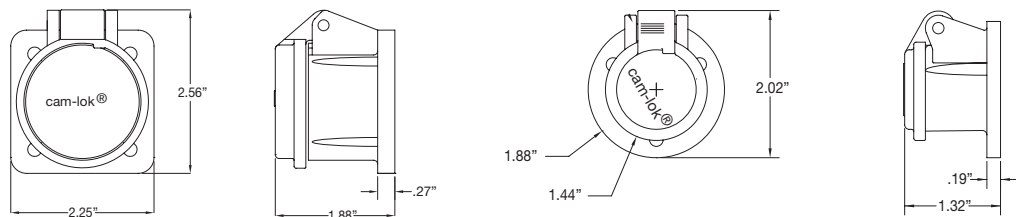
**Snap Back Enclosure Assembly****Color Information:**

BK (Black), RD (Red), GR (Green), WH (White), BU (Blue), BRN (Brown), ORG (Orange), YEL (Yellow)



**Material Characteristics:** Body: Thermoplastic, Environmental: NEMA 3R, Temperature Rating: -40° C to 105° C  
**Specifications and availability are subject to change without notice.**

J-Series E1016, Receptacles

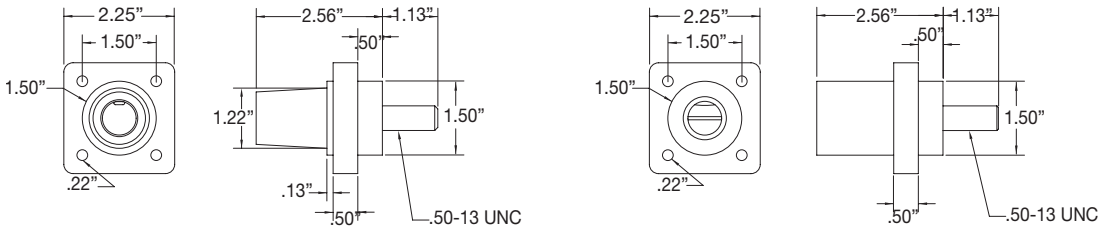

Female & Male E1016 Threaded Stud Receptacles, 1 1/8" Stud

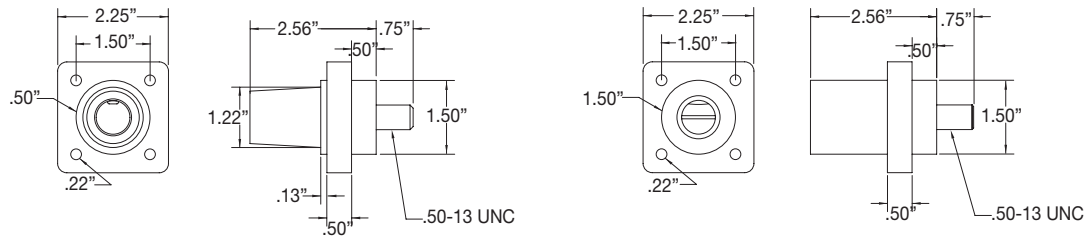

Female & Male E1016 Threaded Stud Receptacles, 3/4" Stud

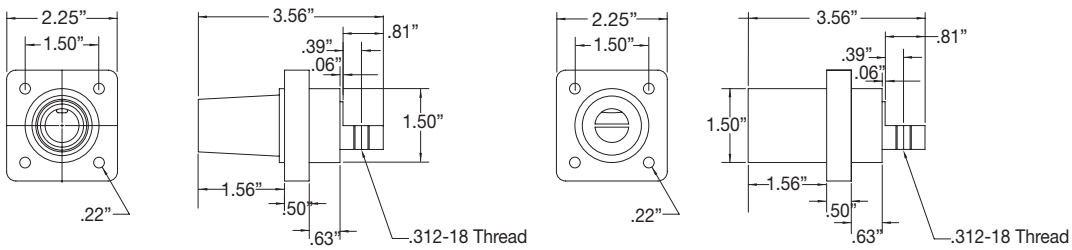

Female & Male E1016 Single Hole Busbar Receptacles

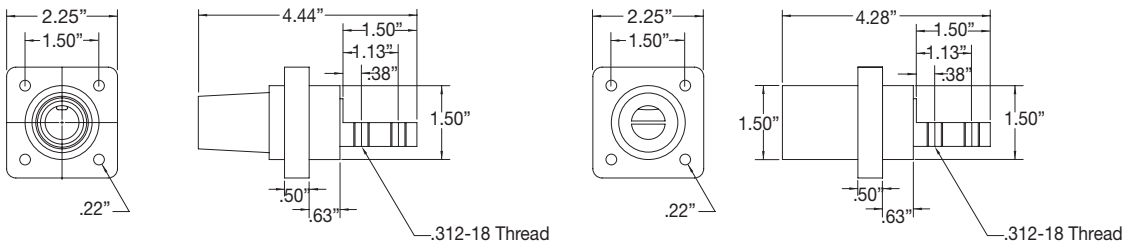

Female & Male E1016 Double Hole Busbar Receptacles

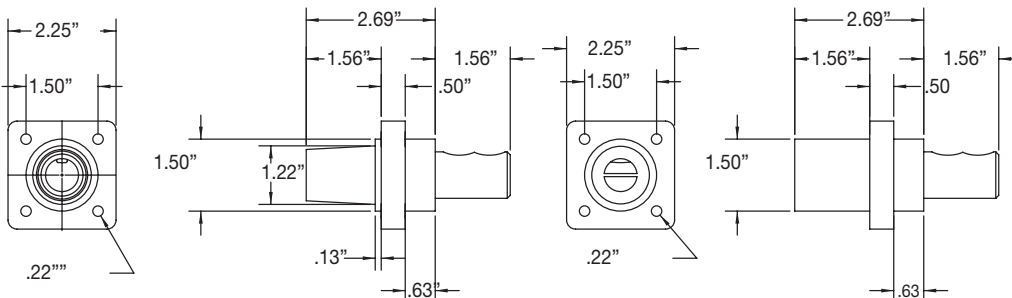

Female & Male E1016 Double Set Screw Receptacles

Specifications and availability are subject to change without notice.

## J-Series E1016 Accessories

600V AC/DC, Up to 400A Continuous  
NEMA 3R



E1016-2324



A100601-17

### J-Series E1016, Elastomeric

#### Features

- Double cam principle provides a positive, vibration-proof connection
- Self-compensating for wear
- No moving contact surfaces, eliminating arcing or burning
- Superior electro-mechanical connections
- Locked contacts will withstand a pulling force of 1,000 lbs
- 1/3 of a turn assures a high pressure contact approaching 600 lbs. per sq. in. providing minimum resistance
- Contacts carefully machined from a high conductivity brass to a smooth sliding fit and easy locking action
- Watertight elastomeric body molded from colorfast material, color-coded for easy phase identification
- Recessed contacts protected by insulating jacket that extends beyond contact ends for safety

### Three-Way Lay-Down "T" Connectors

Color	Paralleling "T" Complete Part No. M-M-F	Tapping "T" Complete Part No. M-F-F	Tapping "T" Complete Part No. M-F-M	Tapping "T" Complete Part No. M-M-M	Tapping "T" Complete Part No. F-F-F	Tapping "T" Complete Part No. F-F-M
BK	E1016-2324	E1016-2312	E1016-2318	E1016-2300	E1016-2306	E1016-2330
RD	E1016-2326	E1016-2314	E1016-2320	E1016-2302	E1016-2308	E1016-2332
GR	E1016-2328	E1016-2316	E1016-2322	E1016-2304	E1016-2310	E1016-2334
WH	E1016-2329	E1016-2317	E1016-2323	E1016-2305	E1016-2311	E1016-2335
BU	E1016-2348	E1016-2350	E1016-2359	E1016-2351	E1016-2349	E1016-2360
BRN	E1016-2371	E1016-2395	E1016-2372	E1016-2373	E1016-2374	E1016-2375
ORG	E1016-2327	E1016-2315	E1016-2321	E1016-2303	E1016-2309	E1016-2333
YEL	E1016-2325	E1016-2313	E1016-2319	E1016-2301	E1016-2307	E1016-2331

### Protective Caps With Lanyards (Not UL Listed or CSA Certified)

Color	Male Cap Part No.	Female Cap Part No.
BK	A100601-17	A100602-17
RD	A100601-19	A100602-19
GR	A100601-21	A100602-21
WH	A100601-22	A100602-22
BU	A100601-24	A100602-24
BRN	A100601-23	A100602-23
ORG	A100601-20	A100602-20
YEL	A100601-18	A100602-18

### Metal Receptacle Covers

Color	Male Cap Part No.	Female Cap Part No.
Plated	A100895-1	Snap Back Metal Cover (Not NEMA 3R)
Aluminum	100444	Spacer

For E1016 "T" Connector Drawings, see Page F-51  
To order single packaged products add a "K" suffix to the complete part number

#### Color Information:

BK (Black), RD (Red), GR (Green), WH (White), BU (Blue), BRN (Brown), ORG (Orange), YEL (Yellow)



**Testing & Code Compliance:** Listed to UL498, file no. E67181, CSA Certified to C22.2, no. 182.3-M1987, file no. LR13963  
**Material Characteristics:** Body: TPE, Environmental: NEMA 3R, Temperature Rating: -40° C to 105° C

Specifications and availability are subject to change without notice.

**J-Series E1016 Accessories** | 600V AC/DC, Up to 400A Continuous  
NEMA 3R

**J-Series E1016, Elastomeric**

- Features**
- Double cam principle provides a positive, vibration-proof connection
  - Self-compensating for wear
  - No moving contact surfaces, eliminating arcing or burning
  - Superior electro-mechanical connections.
  - Locked contacts will withstand a pulling force of 1,000 lbs
  - 1/3 of a turn assures a high pressure contact approaching 600 lbs. per sq. in. providing minimum resistance
  - Contacts carefully machined from a high conductivity brass to a smooth sliding fit and easy locking action
  - Watertight elastomeric body molded from colorfast material, color-coded for easy phase identification
  - Recessed contacts protected by insulating jacket that extends beyond contact ends for safety



E1016-9502



E1016-9510

Three-Fer Tapping Tees	90° M-F-F-F	45° M-F-F-F	45° F-M-M-M
Color	Part No.	Part No.	Part No.
BK	E1016-9500	E1016-9510	E1016-9580
RD	E1016-9502	E1016-9512	E1016-9600
GR	E1016-9504	E1016-9514	E1016-9620
WH	E1016-9505	E1016-9515	E1016-9630
BU	E1016-9506	E1016-9516	E1016-9640
BRN	E1016-9507	E1016-9517	E1016-9650
ORG	E1016-9503	E1016-9513	E1016-9610
YEL	E1016-9501	E1016-9511	E1016-9590

**Adaptors**

Color	Double Male Adapter Part No.	Double Female Adapter Part No.
BK	E1016-2382	E1016-2352
RD	E1016-2384	E1016-2354
GR	E1016-2386	E1016-2356
WH	E1016-2387	E1016-2357
BU	E1016-2388	E1016-2358
BRN	E1016-2389	E1016-2397
ORG	E1016-2385	E1016-2355
YEL	E1016-2383	E1016-2353

For E1016 Elastomeric Drawings, see Page F-51  
To order single packaged products add a "K" suffix to the complete part number

**Color Information:**  
BK (Black), RD (Red), GR (Green), WH (White), BU (Blue), BRN (Brown), ORG (Orange), YEL (Yellow)



**Testing & Code Compliance:** Listed to UL498, file no. E67181, CSA Certified to C22.2, no. 182.3-M1987, file no. LR13963  
**Material Characteristics:** Body: TPE, Environmental: NEMA 3R, Temperature Rating: -40° C to 105° C  
Specifications and availability are subject to change without notice.



**J-Series E1016  
Terminals**600V AC/DC, Up to 400A Continuous  
NEMA 3R

E1016-627



E1016-817

**J-Series E1016, Elastomeric or Rubber****Features**

- Double cam principle provides a positive, vibration-proof connection
- Self-compensating for wear
- No moving contact surfaces, eliminating arcing or burning
- Superior electro-mechanical connections
- Locked contacts will withstand a pulling force of 1,000 lbs
- 1/3 of a turn assures a high pressure contact approaching 600 lbs. per sq. in. providing minimum resistance
- Contacts carefully machined from a high conductivity brass to a smooth sliding fit and easy locking action
- Product body molded from colorfast material, color-coded for easy phase identification; safety terminals are watertight elastomeric, terminal are rubber

**Female Terminal Connectors**

Color	Angle Style Complete Part No.	Offset Style Complete Part No.
BK	E1016-575	E1016-625
RD	E1016-577	E1016-627
GR	E1016-579	E1016-629
WH	E1016-580	E1016-630
BU	E1016-587	E1016-638
BRN	E1016-590	E1016-639
ORG	E1016-578	E1016-628
YEL	E1016-576	E1016-626

Hole Size: 1/2"

**Female Safety Terminals**

Color	Round Complete Part No.	Rectangular Complete Part No.
BK	E1016-813	E1016-801
RD	E1016-815	E1016-803
GR	E1016-817	E1016-805
WH	E1016-818	E1016-806
BU	E1016-819	E1016-807
BRN	E1016-820	E1016-808
ORG	E1016-816	E1016-804
YEL	E1016-814	E1016-802

Tapped Hole: 1/2"-13

For E1016 Elastomeric or Rubber Drawings, see Page F-52

To order single packaged products add a "K" suffix to the complete part number

**Color Information:**

BK (Black), RD (Red), GR (Green), WH (White), BU (Blue), BRN (Brown), ORG (Orange), YEL (Yellow)

**Testing & Code Compliance:** Listed to UL498, file no. E67181, CSA Certified to C22.2, no. 182.3-M1987, file no. LR13963**Material Characteristics:** Insulator: Rubber, Environmental: NEMA 3R, Temperature Rating: -40° C to 105° C**Specifications and availability are subject to change without notice.**

## J-Series E1017 Vulcanized Plugs

Cable Size 350-500 MCM  
600V AC/DC, Up to 545A Continuous  
NEMA 3R

### J-Series E1017, Rubber, Vulcanized, Double Set Screw Connection

#### Features

- Double cam principle provides a positive, vibration-proof connection
- Self-compensating for wear
- No moving contact surfaces, eliminating arcing or burning
- Superior electro-mechanical connections
- Locked contacts will withstand a pulling force of 1,000 lbs
- 1/3 of a turn assures a high pressure contact approaching 600 lbs. per sq. inch providing minimum resistance
- Contacts carefully machined from a high conductivity brass to a smooth sliding fit and easy locking action
- Watertight rubber insulators molded from colorfast material, color-coded for easy phase identification
- Recessed contacts protected by insulating jacket that extends beyond contact ends for safety
- Integrated strain relief system features a retaining wire that prevents cable jacket pull-away and bare conductor exposure
- Plugs feature a high-strength, molded-in-place locking ring to capture and secure the insulator to the contact
- Accepts a wide range of cable sizes



E1017-356



E1017-377

### Double Set Screw Vulcanized Male Plugs

Cable Size	Color	Complete Part No.	Contact Only Part No.	Insulator Only Part No.
350-500MCM	BK	E1017-350	A200612-1	A200056-1
	RD	E1017-352	A200612-1	A200056-3
	GR	E1017-354	A200612-1	A200056-5
	WH	E1017-355	A200612-1	A200056-6
	BU	E1017-356	A200612-1	A200056-37
	BRN	E1017-357	A200612-1	A200056-42
	ORG	E1017-353	A200612-1	A200056-4
	YEL	E1017-351	A200612-1	A200056-2

### Double Set Screw Vulcanized Female Plugs

Cable Size	Color	Complete Part No.	Contact Only Part No.	Insulator Only Part No.
350-500MCM	BK	E1017-375	A200614-2	A200040-1
	RD	E1017-377	A200614-2	A200040-3
	GR	E1017-379	A200614-2	A200040-5
	WH	E1017-380	A200614-2	A200040-6
	BU	E1017-381	A200614-2	A200040-39
	BRN	E1017-382	A200614-2	A200040-37
	ORG	E1017-378	A200614-2	A200040-4
	YEL	E1017-376	A200614-2	A200040-2

For E1017 Rubber, Non-Vulcanized, Double Set Screw Connection Drawings, see Page F-52  
To order single packaged products add a "K" suffix to the complete part number

#### Color Information:

BK (Black), RD (Red), GR (Green), WH (White), BU (Blue), BRN (Brown), ORG (Orange), YEL (Yellow)



**Testing & Code Compliance:** Listed to UL498, file no. E67181, CSA Certified to C22.2, no. 182.3-M1987, file no. LR13963

**Material Characteristics:** Insulator: Rubber, Environmental: NEMA 3R, Temperature Rating: -40° C to 105° C

Specifications and availability are subject to change without notice.

**J-Series E1017  
Vulcanized Plugs**

Cable Size 250 MCM  
600V AC/DC, Up to 340A Continuous  
NEMA 3R



E1017-108



E1017-113

**J-Series E1017, Rubber, Vulcanized Crimp Connection****Features**

- Double cam principle provides a positive, vibration-proof connection
- Self-compensating for wear
- No moving contact surfaces, eliminating arcing or burning
- Superior electro-mechanical connections
- Locked contacts will withstand a pulling force of 1,000 lbs
- 1/3 of a turn assures a high pressure contact approaching 600 lbs. per sq. inch providing minimum resistance
- Contacts carefully machined from a high conductivity brass to a smooth sliding fit and easy locking action
- Watertight rubber insulators molded from colorfast material, color-coded for easy phase identification
- Recessed contacts protected by insulating jacket that extends beyond contact ends for safety
- Integrated strain relief system features a retaining wire that prevents cable jacket pull-away and bare conductor exposure
- Plugs feature a high-strength, molded-in-place locking ring to capture and secure the insulator to the contact

**Crimp Vulcanized Male Plugs (Not UL Listed)**

Cable Size	Color	Complete Part No.	Contact Only Part No.	Insulator Only Part No.
250MCM	BK	E1017-94	A200028-13	A200056-1
	RD	E1017-92	A200028-13	A200056-3
	GR	E1017-93	A200028-13	A200056-5
	WH	E1017-95	A200028-13	A200056-6
	BU	E1017-96	A200028-13	A200056-37
	BRN	E1017-108	A200028-13	A200056-42
	ORG	E1017-109	A200028-13	A200056-4
	YEL	E1017-110	A200028-13	A200056-2

**Crimp Vulcanized Female Plugs (Not UL Listed)**

Cable Size	Color	Complete Part No.	Contact Only Part No.	Insulator Only Part No.
250MCM	BK	E1017-90	A200027-5	A200040-1
	RD	E1017-88	A200027-5	A200040-3
	GR	E1017-89	A200027-5	A200040-5
	WH	E1017-91	A200027-5	A200040-6
	BU	E1017-98	A200027-5	A200040-39
	BRN	E1017-111	A200027-5	A200040-37
	ORG	E1017-112	A200027-5	A200040-4
	YEL	E1017-113	A200027-5	A200040-2

For E1017 Rubber, Vulcanized Crimp Connection Drawings, see Page F-52  
To order single packaged products add a "K" suffix to the complete part number

**Color Information:**

BK (Black), RD (Red), GR (Green), WH (White), BU (Blue), BRN (Brown), ORG (Orange), YEL (Yellow)



**Testing & Code Compliance:** Listed to UL498, file no. E67181, CSA Certified to C22.2, no. 182.3-M1987, file no. LR13963  
**Material Characteristics:** Insulator: Rubber, Environmental: NEMA 3R, Temperature Rating: -40° C to 105° C

Specifications and availability are subject to change without notice.

## J-Series E1017 Vulcanized Plugs

Cable Size 350 MCM  
600V AC/DC, Up to 445A Continuous  
NEMA 3R

### J-Series E1017, Rubber, Vulcanized Crimp Connection

#### Features

- Double cam principle provides a positive, vibration-proof connection
- Self-compensating for wear
- No moving contact surfaces, eliminating arcing or burning
- Superior electro-mechanical connections
- Locked contacts will withstand a pulling force of 1,000 lbs
- 1/3 of a turn assures a high pressure contact approaching 600 lbs. per sq. inch providing minimum resistance
- Contacts carefully machined from a high conductivity brass to a smooth sliding fit and easy locking action
- Watertight rubber insulators molded from colorfast material, color-coded for easy phase identification
- Recessed contacts protected by insulating jacket that extends beyond contact ends for safety
- Integrated strain relief system features a retaining wire that prevents cable jacket pull-away and bare conductor exposure
- Plugs feature a high-strength, molded-in-place locking ring to capture and secure the insulator to the contact



E1017-26



E1017-79

### Crimp Vulcanized Male Plugs

Cable Size	Color	Complete Part No.	Contact Only Part No.	Insulator Only Part No.
350MCM	BK	E1017-1	A200028-1	A200056-1
	RD	E1017-3	A200028-1	A200056-3
	GR	E1017-5	A200028-1	A200056-5
	WH	E1017-6	A200028-1	A200056-6
	BU	E1017-26	A200028-1	A200056-37
	BRN	E1017-31	A200028-1	A200056-42
	ORG	E1017-4	A200028-1	A200056-4
	YEL	E1017-2	A200028-1	A200056-2

### Crimp Vulcanized Female Plugs

Cable Size	Color	Complete Part No.	Contact Only Part No.	Insulator Only Part No.
350MCM	BK	E1017-50	A200027-5	A200040-1
	RD	E1017-52	A200027-5	A200040-3
	GR	E1017-54	A200027-5	A200040-5
	WH	E1017-55	A200027-5	A200040-6
	BU	E1017-74	A200027-5	A200040-39
	BRN	E1017-79	A200027-5	A200040-37
	ORG	E1017-53	A200027-5	A200040-4
	YEL	E1017-51	A200027-5	A200040-2

For E1017 Rubber, Vulcanized Crimp Connection Drawings, see Page F-52  
To order single packaged products add a "K" suffix to the complete part number

#### Color Information:

BK (Black), RD (Red), GR (Green), WH (White), BU (Blue), BRN (Brown), ORG (Orange), YEL (Yellow)



**Testing & Code Compliance:** Listed to UL498, file no. E67181, CSA Certified to C22.2, no. 182.3-M1987, file no. LR13963  
**Material Characteristics:** Insulator: Rubber, Environmental: NEMA 3R, Temperature Rating: -40° C to 105° C

Specifications and availability are subject to change without notice.

**J-Series E1017  
Vulcanized Plugs**

Cable Size 500 MCM  
600V AC/DC, Up to 545A Continuous  
NEMA 3R



E1017-9



E1017-61

**J-Series E1017, Rubber, Vulcanized Crimp Connection****Features**

- Double cam principle provides a positive, vibration-proof connection
- Self-compensating for wear
- No moving contact surfaces, eliminating arcing or burning
- Superior electro-mechanical connections
- Locked contacts will withstand a pulling force of 1,000 lbs
- 1/3 of a turn assures a high pressure contact approaching 600 lbs. per sq. inch providing minimum resistance
- Contacts carefully machined from a high conductivity brass to a smooth sliding fit and easy locking action
- Watertight rubber insulators molded from colorfast material, color-coded for easy phase identification
- Recessed contacts protected by insulating jacket that extends beyond contact ends for safety
- Integrated strain relief system features a retaining wire that prevents cable jacket pull-away and bare conductor exposure
- Plugs feature a high-strength, molded-in-place locking ring to capture and secure the insulator to the contact

**Crimp Vulcanized Male Plugs**

Cable Size	Color	Complete Part No.	Contact Only Part No.	Insulator Only Part No.
500MCM	BK	E1017-7	A200028-2	A200056-1
	RD	E1017-9	A200028-2	A200056-3
	GR	E1017-11	A200028-2	A200056-5
	WH	E1017-12	A200028-2	A200056-6
	BU	E1017-27	A200028-2	A200056-37
	BRN	E1017-32	A200028-2	A200056-42
	ORG	E1017-10	A200028-2	A200056-4
	YEL	E1017-8	A200028-2	A200056-2

**Crimp Vulcanized Female Plugs**

Cable Size	Color	Complete Part No.	Contact Only Part No.	Insulator Only Part No.
500MCM	BK	E1017-56	A200027-6	A200040-1
	RD	E1017-58	A200027-6	A200040-3
	GR	E1017-60	A200027-6	A200040-5
	WH	E1017-61	A200027-6	A200040-6
	BU	E1017-75	A200027-6	A200040-39
	BRN	E1017-80	A200027-6	A200040-37
	ORG	E1017-59	A200027-6	A200040-4
	YEL	E1017-57	A200027-6	A200040-2

For E1017 Rubber, Vulcanized Crimp Connection Drawings, see Page F-52  
To order single packaged products add a "K" suffix to the complete part number

**Color Information:**

BK (Black), RD (Red), GR (Green), WH (White), BU (Blue), BRN (Brown), ORG (Orange), YEL (Yellow)



**Testing & Code Compliance:** Listed to UL498, file no. E67181, CSA Certified to C22.2, no. 182.3-M1987, file no. LR13963  
**Material Characteristics:** Insulator: Rubber, Environmental: NEMA 3R, Temperature Rating: -40° C to 105° C

Specifications and availability are subject to change without notice.

## J-Series E1017 Vulcanized Plugs

Cable Size 750 MCM  
600V AC/DC, Up to 690A Continuous  
NEMA 3R

### J-Series E1017, Rubber, Vulcanized Crimp Connection

#### Features

- Double cam principle provides a positive, vibration-proof connection
- Self-compensating for wear
- No moving contact surfaces, eliminating arcing or burning
- Superior electro-mechanical connections
- Locked contacts will withstand a pulling force of 1,000 lbs
- 1/3 of a turn assures a high pressure contact approaching 600 lbs. per sq. inch providing minimum resistance
- Contacts carefully machined from a high conductivity brass to a smooth sliding fit and easy locking action
- Watertight rubber insulators molded from colorfast material, color-coded for easy phase identification
- Recessed contacts protected by insulating jacket that extends beyond contact ends for safety
- Integrated strain relief system features a retaining wire that prevents cable jacket pull-away and bare conductor exposure
- Plugs feature a high-strength, molded-in-place locking ring to capture and secure the insulator to the contact



E1017-18



E1017-76

### Crimp Vulcanized Male Plugs

Cable Size	Color	Complete Part No.	Contact Only Part No.	Insulator Only Part No.
750MCM	BK	E1017-13	A200028-3	A200056-7
	RD	E1017-15	A200028-3	A200056-9
	GR	E1017-17	A200028-3	A200056-11
	WH	E1017-18	A200028-3	A200056-12
	BU	E1017-28	A200028-3	A200056-41
	BRN	E1017-33	A200028-3	A200056-43
	ORG	E1017-16	A200028-3	A200056-10
	YEL	E1017-14	A200028-3	A200056-8

### Crimp Vulcanized Female Plugs

Cable Size	Color	Complete Part No.	Contact Only Part No.	Insulator Only Part No.
750MCM	BK	E1017-62	A200027-7	A200040-7
	RD	E1017-64	A200027-7	A200040-9
	GR	E1017-66	A200027-7	A200040-11
	WH	E1017-67	A200027-7	A200040-12
	BU	E1017-76	A200027-7	A200040-40
	BRN	E1017-81	A200027-7	A200040-38
	ORG	E1017-65	A200027-7	A200040-10
	YEL	E1017-63	A200027-7	A200040-8

For E1017 Rubber, Rubber, Vulcanized Crimp Connection Drawings, see Page F-52  
To order single packaged products add a "K" suffix to the complete part number

#### Color Information:

BK (Black), RD (Red), GR (Green), WH (White), BU (Blue), BRN (Brown), ORG (Orange), YEL (Yellow)



**Testing & Code Compliance:** Listed to UL498, file no. E67181, CSA Certified to C22.2, no. 182.3-M1987, file no. LR13963  
**Material Characteristics:** Insulator: Rubber, Environmental: NEMA 3R, Temperature Rating: -40° C to 105° C

Specifications and availability are subject to change without notice.

**J-Series E1017  
Vulcanized Plugs**

Cable Size 800 MCM  
600V AC/DC, Up to 690A Continuous  
NEMA 3R



E1017-24



E1017-71

**J-Series E1017, Rubber, Vulcanized Crimp Connection****Features**

- Double cam principle provides a positive, vibration-proof connection
- Self-compensating for wear
- No moving contact surfaces, eliminating arcing or burning
- Superior electro-mechanical connections
- Locked contacts will withstand a pulling force of 1,000 lbs
- 1/3 of a turn assures a high pressure contact approaching 600 lbs. per sq. inch providing minimum resistance
- Contacts carefully machined from a high conductivity brass to a smooth sliding fit and easy locking action
- Watertight rubber insulators molded from colorfast material, color-coded for easy phase identification
- Recessed contacts protected by insulating jacket that extends beyond contact ends for safety
- Integrated strain relief system features a retaining wire that prevents cable jacket pull-away and bare conductor exposure
- Plugs feature a high-strength, molded-in-place locking ring to capture and secure the insulator to the contact

**Crimp Vulcanized Male Plugs (Not UL Listed)**

Cable Size	Color	Complete Part No.	Contact Only Part No.	Insulator Only Part No.
800MCM	BK	E1017-19	A200028-4	A200056-7
	RD	E1017-21	A200028-4	A200056-9
	GR	E1017-23	A200028-4	A200056-11
	WH	E1017-24	A200028-4	A200056-12
	BU	E1017-29	A200028-4	A200056-41
	BRN	E1017-34	A200028-4	A200056-43
	ORG	E1017-22	A200028-4	A200056-10
	YEL	E1017-20	A200028-4	A200056-8

**Crimp Vulcanized Female Plugs (Not UL Listed)**

Cable Size	Color	Complete Part No.	Contact Only Part No.	Insulator Only Part No.
800MCM	BK	E1017-68	A200027-8	A200040-7
	RD	E1017-70	A200027-8	A200040-9
	GR	E1017-72	A200027-8	A200040-11
	WH	E1017-73	A200027-8	A200040-12
	BU	E1017-77	A200027-8	A200040-40
	BRN	E1017-82	A200027-8	A200040-38
	ORG	E1017-71	A200027-8	A200040-10
	YEL	E1017-69	A200027-8	A200040-8

For E1017 Rubber, Vulcanized Crimp Connection Drawings, see Page F-52  
To order single packaged products add a "K" suffix to the complete part number

**Color Information:**

BK (Black), RD (Red), GR (Green), WH (White), BU (Blue), BRN (Brown), ORG (Orange), YEL (Yellow)



**Testing & Code Compliance:** Listed to UL498, file no. E67181, CSA Certified to C22.2, no. 182.3-M1987, file no. LR13963  
**Material Characteristics:** Insulator: Rubber, Environmental: NEMA 3R, Temperature Rating: -40° C to 105° C

**Specifications and availability are subject to change without notice.**

## J-Series E1017 Receptacles

Cable Size 350-750 MCM  
600V AC/DC, Up to 690A Continuous  
NEMA 3R

### J-Series E1017, Rubber, Threaded Stud

#### Features

- Double cam principle provides a positive, vibration-proof connection
- Self-compensating for wear
- No moving contact surfaces, eliminating arcing or burning of contacts
- Superior electro-mechanical connections
- Locked contacts will withstand a pulling force of 1,000 lbs
- 1/3 of a turn assures a high pressure contact approaching 600 lbs. per sq. inch providing minimum resistance
- Contacts carefully machined from a high conductivity brass to a smooth sliding fit and easy locking action
- Watertight rubber body molded from colorfast material, color-coded for easy phase identification
- Recessed contacts protected by insulating jacket that extends beyond contact ends for safety
- Receptacles are safety insulated for direct mounting to steel panels
- Accepts a wide range of cable sizes



E1017-1604



E1017-1637

### Threaded Male Receptacles

Cable Size	Color	90° Complete Part No.	30° Complete Part No.
350-750MCM	BK	E1017-1600	E1017-1601
	RD	E1017-1604	E1017-1605
	GR	E1017-1608	E1017-1609
	WH	E1017-1610	E1017-1611
	BU	E1017-1612	E1017-1613
	BRN	E1017-1614	E1017-1615
	ORG	E1017-1606	E1017-1607
	YEL	E1017-1602	E1017-1603

### Threaded Female Receptacles

Cable Size	Color	Complete Part No.	Contact Only Part No.
350-750MCM	BK	E1017-1625	E1017-1626
	RD	E1017-1629	E1017-1630
	GR	E1017-1633	E1017-1634
	WH	E1017-1635	E1017-1636
	BU	E1017-1637	E1017-1638
	BRN	E1017-1641	E1017-1642
	ORG	E1017-1631	E1017-1632
	YEL	E1017-1627	E1017-1628

Stud Size 1/2"-13, Maximum Torque: 40 ft. lbs.  
For E1017 Rubber, Threaded Stud Drawings, see Page F-52  
To order single packaged products add a "K" suffix to the complete part number

#### Color Information:

BK (Black), RD (Red), GR (Green), WH (White), BU (Blue), BRN (Brown), ORG (Orange), YEL (Yellow)

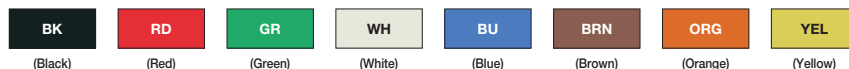

**Testing & Code Compliance:** Listed to UL498, file no. E67181, CSA Certified to C22.2, no. 182.3-M1987, file no. LR13963

**Material Characteristics:** Insulator: Rubber, Environmental: NEMA 3R, Temperature Rating: -40° C to 105° C

Specifications and availability are subject to change without notice.



## J-Series E1017 Receptacles & Terminals

Cable Size 350-750 MCM  
600V AC/DC, Up to 690A Continuous  
NEMA 3R



E1017-515



E1017-575

### J-Series E1017 Receptacles and Terminal Connectors

#### Features

- Double cam principle provides a positive, vibration-proof connection
- Self-compensating for wear
- No moving contact surfaces, eliminating arcing or burning
- Superior electro-mechanical connections
- Locked contacts will withstand a pulling force of 1,000 lbs
- Accepts a wide range of cable sizes
- 1/3 of a turn assures a high pressure contact approaching 600 lbs. per sq. in. providing minimum resistance
- Contacts carefully machined from a high conductivity brass to a smooth sliding fit and easy locking action
- Watertight rubber insulators molded from colorfast material, color-coded for easy phase identification
- Recessed contacts protected by insulating jacket that extends beyond contact ends for safety

### Female Receptacles with Inter-Lock Switch (Not UL Listed or CSA Certified)

Cable Size	Style	Color	90° Complete Part No.	30° Complete Part No.
350-750MCM	With Interlock Switch 480 Volts Max	BK	E1017-509	E1017-501
		RD	E1017-511	E1017-503
		GR	E1017-513	E1017-505
		WH	E1017-514	E1017-506
		BU	E1017-515	E1017-507
		BRN	E1017-516	E1017-508
		ORG	E1017-512	E1017-504
		YEL	E1017-510	E1017-502

### Female Terminals

Color	Angle Style Complete Part No.	Offset Style Complete Part No.
BK	E1017-575	E1017-625
RD	E1017-577	E1017-627
GR	E1017-579	E1017-629
WH	E1017-580	E1017-630
BU	E1017-581	E1017-631
BRN	E1017-582	E1017-632
ORG	E1017-578	E1017-628
YEL	E1017-576	E1017-626

For E1017 Receptacles and Terminal Connectors Drawings, see Page F-52  
To order single packaged products add a "K" suffix to the complete part number

#### Color Information:

BK (Black), RD (Red), GR (Green), WH (White), BU (Blue), BRN (Brown), ORG (Orange), YEL (Yellow)



**Testing & Code Compliance:** Listed to UL498, file no. E67181, CSA Certified to C22.2, no. 182.3-M1987, file no. LR13963  
**Material Characteristics:** Insulator: Rubber, Environmental: NEMA 3R, Temperature Rating: -40° C to 105° C

Specifications and availability are subject to change without notice.

**J-Series E1017 Protective Caps** | NEMA 3R

**J-Series E1017 Caps**

**Features**

- Resilient rubber body provides superior protection against elements
- Molded from colorfast material color-coded for easy phase identification
- Provides NEMA 3R protection
- Complete color offering
- Lanyard provided to prevent loss
- Attaches directly to new or existing plugs and receptacles

**Protective Caps with Lanyards (Not UL Listed or CSA Certified)**

Color	Male Cap Part No.	Female Cap Part No.
BK	A100603-2	A100604-2
RD	A100603-6	A100604-6
GR	A100603-10	A100604-10
WH	A100603-12	A100604-12
BU	A100603-16	A100604-16
BRN	A100603-14	A100604-14
ORG	A100603-8	A100604-8
YEL	A100603-4	A100604-4

For E1017 Protective Caps Drawings, see Page F-52  
 To order single packaged products add a "K" suffix to the complete part number



A100603-2



A100604-2

**Color Information:**

BK (Black), RD (Red), GR (Green), WH (White), BU (Blue), BRN (Brown), ORG (Orange), YEL (Yellow)



**Material Characteristics:** Body: Rubber, Environmental: NEMA 3R, Temperature Rating: -40° C to 105° C

Specifications and availability are subject to change without notice.

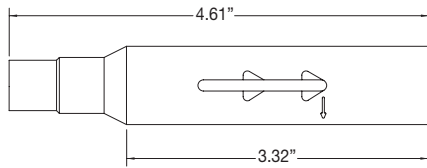
**J-Series E1015, Elastomeric, Non-Vulcanized, Single Set Screw Connection**

Male Non-Vulcanized Plug

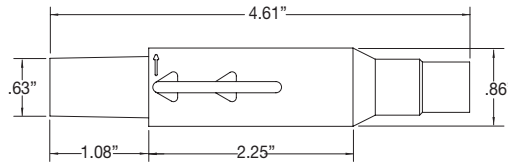

Female Non-Vulcanized Plug

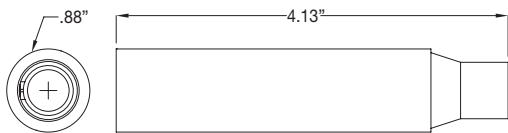
**J-Series E1015, Rubber, Vulcanized, Crimp Connection**

Male Vulcanized Plug

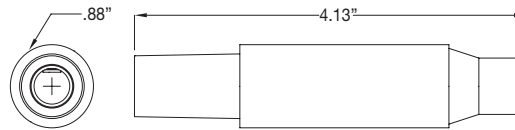

Female Vulcanized Plug

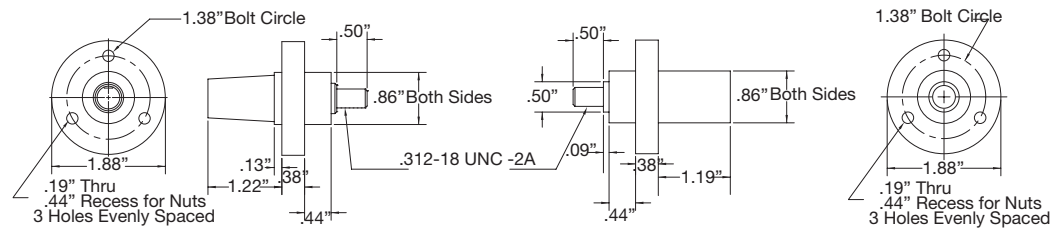
**J-Series E1015, Elastomeric or Rubber**

Male &amp; Female Receptacles

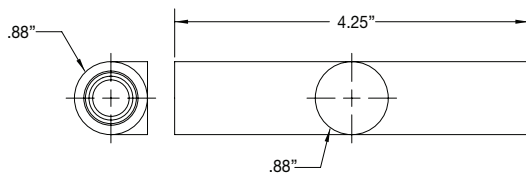
**J-Series E1015, Rubber**

Tapping Tee

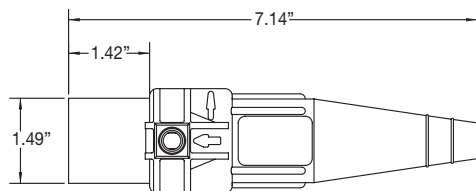
**J-Series E-Z1016, Elastomeric, Non-Vulcanized, Double Set Screw Connection & Crimp Connection**

Male Connector

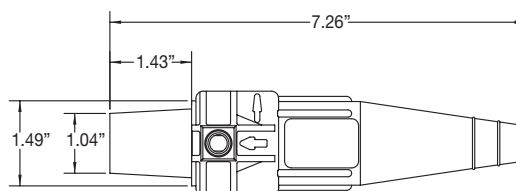

Female Connector

Specifications and availability are subject to change without notice.

J-Series E1016, Elastomeric, Non-Vulcanized, Double Set Screw Connection & Crimp Connection

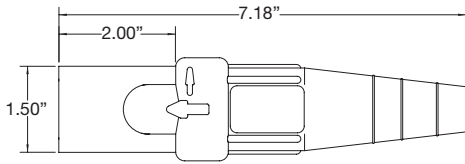

Male Non-Vulcanized Plug

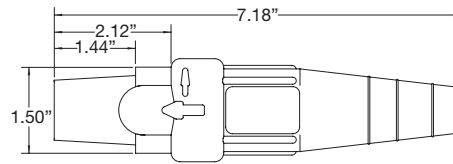

Female Non-Vulcanized Plug

J-Series E1016, Rubber, Vulcanized, Crimp Connection

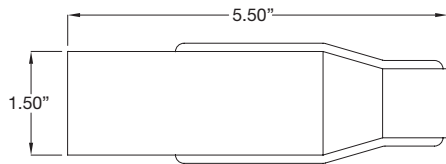

Male Vulcanized Plug

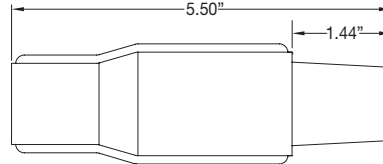

Female Vulcanized Plug



J-Series E1016, Elastomeric - Double Set Screw/Inter-Lock Switch

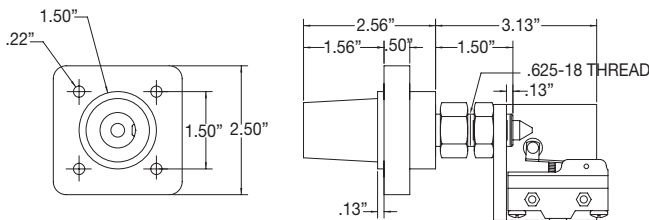

Female Receptacle Assembly With Interlock Switch

J-Series E1016, Elastomeric

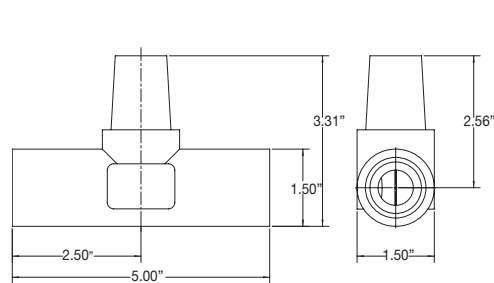

Three-Way Lay-Down "T" Connectors

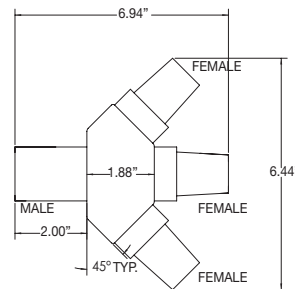

Three-fer Tapping Tee 45° M-F-F-F

Specifications and availability are subject to change without notice.



**Standard Series  
E-Z1018 Plugs**

Cable Size #2 AWG – 2/0  
600V AC/DC, Up to 300A Continuous  
NEMA 3R

**Standard Series E-Z1018, Elastomeric, Non-Vulcanized, Double Set Screw Connection**

**Features**

- E-Z assembly and disassembly
- Double cam principle provides a positive, vibration-proof connection
- Self-compensating for wear
- No moving contact surfaces, eliminating arcing or burning
- Superior electro-mechanical connections
- Locked contacts will withstand a pulling force of 1,000 lbs
- 1/3 of a turn assures a high pressure contact approaching 600 lbs. per sq. in. providing minimum resistance
- Contacts carefully machined from a high conductivity brass to a smooth sliding fit and easy locking action
- Watertight elastomeric insulators molded from colorfast material, color-coded for easy phase identification
- Accepts a wide range of cable sizes



E-Z1018-8354



E-Z1018-8381

**Double Set Screw Non-Vulcanized Male Plugs**

Cable Size	Color	Complete Part No.	Contact Only Part No.	Insulator Only Part No.
#2-2/0	BK	E-Z1018-8350	A200630-1	E-Z200071-19
	RD	E-Z1018-8352	A200630-1	E-Z200071-21
	GR	E-Z1018-8354	A200630-1	E-Z200071-23
	WH	E-Z1018-8355	A200630-1	E-Z200071-24
	BU	E-Z1018-8356	A200630-1	E-Z200071-37
	BRN	E-Z1018-8357	A200630-1	E-Z200071-39
	ORG	E-Z1018-8353	A200630-1	E-Z200071-22
	YEL	E-Z1018-8351	A200630-1	E-Z200071-20

**Double Set Screw Non-Vulcanized Female Plugs**

Cable Size	Color	Complete Part No.	Contact Only Part No.	Insulator Only Part No.
#2-2/0	BK	E-Z1018-8375	A200640-4	E-Z200072-19
	RD	E-Z1018-8377	A200640-4	E-Z200072-21
	GR	E-Z1018-8379	A200640-4	E-Z200072-23
	WH	E-Z1018-8380	A200640-4	E-Z200072-24
	BU	E-Z1018-8381	A200640-4	E-Z200072-37
	BRN	E-Z1018-8382	A200640-4	E-Z200072-39
	ORG	E-Z1018-8378	A200640-4	E-Z200072-22
	YEL	E-Z1018-8376	A200640-4	E-Z200072-20

For E-Z1018 Elastomeric, Non-Vulcanized Double Set Screw Connection Drawings, see Page F-59  
To order single packaged products add a "K" suffix to the complete part number

**Color Information:**

BK (Black), RD (Red), GR (Green), WH (White), BU (Blue), BRN (Brown), ORG (Orange), YEL (Yellow)

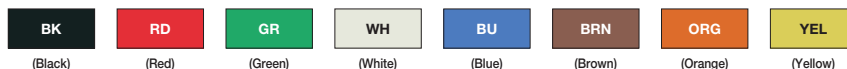

**Testing & Code Compliance:** CSA Certified to C22.2, no. 182.3-M1987, file no. LR13963 **Material Characteristics:** Insulator: TPE, Environmental: NEMA 3R, Temperature Rating: -40° C to 105° C

Specifications and availability are subject to change without notice.

**Standard Series  
E-Z1018 Plugs**

Cable Size 2/0 – 4/0  
600V AC/DC, Up to 400A Continuous  
NEMA 3R



E-Z1018-8364



E-Z1018-8390

**Standard Series E-Z1018, Elastomeric, Non-Vulcanized, Double Set Screw Connection****Features**

- E-Z assembly and disassembly
- Double cam principle provides a positive, vibration-proof connection
- Self-compensating for wear
- No moving contact surfaces, eliminating arcing or burning
- Superior electro-mechanical connections
- Locked contacts will withstand a pulling force of 1,000 lbs
- 1/3 of a turn assures a high pressure contact approaching 600 lbs. per sq. in. providing minimum resistance
- Contacts carefully machined from a high conductivity brass to a smooth sliding fit and easy locking action
- Watertight elastomeric insulators molded from colorfast material, color-coded for easy phase identification
- Accepts a wide range of cable sizes

**Double Set Screw Non-Vulcanized Male Plugs**

Cable Size	Color	Complete Part No.	Contact Only Part No.	Insulator Only Part No.
2/0-4/0	BK	E-Z1018-8362	A200639-1	E-Z200071-13
	RD	E-Z1018-8364	A200639-1	E-Z200071-15
	GR	E-Z1018-8366	A200639-1	E-Z200071-17
	WH	E-Z1018-8367	A200639-1	E-Z200071-18
	BU	E-Z1018-8368	A200639-1	E-Z200071-38
	BRN	E-Z1018-8369	A200639-1	E-Z200071-41
	ORG	E-Z1018-8365	A200639-1	E-Z200071-16
	YEL	E-Z1018-8363	A200639-1	E-Z200071-14

**Double Set Screw Non-Vulcanized Female Plugs**

Cable Size	Color	Complete Part No.	Contact Only Part No.	Insulator Only Part No.
2/0-4/0	BK	E-Z1018-8387	A200641-2	E-Z200072-13
	RD	E-Z1018-8389	A200641-2	E-Z200072-15
	GR	E-Z1018-8391	A200641-2	E-Z200072-17
	WH	E-Z1018-8392	A200641-2	E-Z200072-18
	BU	E-Z1018-8393	A200641-2	E-Z200072-38
	BRN	E-Z1018-8394	A200641-2	E-Z200072-41
	ORG	E-Z1018-8390	A200641-2	E-Z200072-16
	YEL	E-Z1018-8388	A200641-2	E-Z200072-14

For E-Z1018 Elastomeric, Non-Vulcanized Double Set Screw Connection Drawings, see Page F-59  
To order single packaged products add a "K" suffix to the complete part number

**Color Information:**

BK (Black), RD (Red), GR (Green), WH (White), BU (Blue), BRN (Brown), ORG (Orange), YEL (Yellow)



**Testing & Code Compliance:** CSA Certified to C22.2, no. 182.3-M1987, file no. LR13963 **Material Characteristics:** Insulator: TPE, Environmental: NEMA 3R, Temperature Rating: -40° C to 105° C

**Specifications and availability are subject to change without notice.**

## Standard Series E1018 Receptacles & Accessories

Cable Size #2 AWG – 4/0  
600V AC/DC, Up to 400A Continuous  
NEMA 3R

### Standard Series E1018 Elastomeric, Double Set Screw

#### Features

- Double cam principle provides a positive, vibration-proof connection
- Self-compensating for wear
- No moving contact surfaces, eliminating arcing or burning
- Superior electro-mechanical connections
- Locked contacts will withstand a pulling force of 1,000 lbs
- Receptacles are safety insulated for direct mounting to steel panels
- 1/3 of a turn assures a high pressure contact approaching 600 lbs. per sq. in. providing minimum resistance
- Contacts carefully machined from a high conductivity brass to a smooth sliding fit and easy locking action
- Watertight elastomeric body molded from colorfast material, color-coded for easy phase identification
- Recessed contacts protected by insulating jacket that extends beyond contact ends for safety



E1018-1700



E1018-1725

### Insulated Receptacles Double Set Screw

Tightening Torque		Color	Male Complete Part No.	Female Complete Part No.
Cable	Torque (In lbs)	BK	E1018-1700	E1018-1725
#2-#1	100	RD	E1018-1702	E1018-1727
1/0-2/0	120	GR	E1018-1704	E1018-1729
3/0-4/0	220	WH	E1018-1705	E1018-1730
		BU	E1018-1706	E1018-1731
		BRN	E1018-1707	E1018-1732
		ORG	E1018-1703	E1018-1728
		YEL	E1018-1701	E1018-1726

### Three-fer Tapping Tee 45° M-F-F-F

Color	Part No.
BK	E1018-9510
RD	E1018-9512
GR	E1018-9514
WH	E1018-9515
BU	E1018-9516
BRN	E1018-9517
ORG	E1018-9513
YEL	E1018-9511

For E1018 Elastomeric, Double Set Screw Connection Drawings, see Page F-59  
To order single packaged products add a "K" suffix to the complete part number

#### Color Information:

BK (Black), RD (Red), GR (Green), WH (White), BU (Blue), BRN (Brown), ORG (Orange), YEL (Yellow)

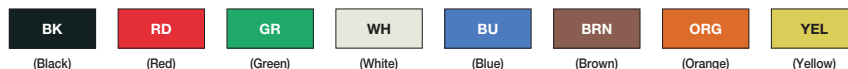

**Testing & Code Compliance:** CSA Certified to C22.2, no. 182.3-M1987, file no. LR13963 **Material Characteristics:** Insulator: TPE, Environmental: NEMA 3R, Temperature Rating: -40° C to 105° C

Specifications and availability are subject to change without notice.



**Standard Series  
E1018 Receptacles**

Cable Size #2 AWG – 4/0  
600V AC/DC, Up to 400A Continuous  
NEMA 3R



E1018-1600



E1018-1631

**Standard Series E1018 Elastomeric, Threaded Stud****Features**

- Double cam principle provides a positive, vibration-proof connection
- Self-compensating for wear
- No moving contact surfaces, eliminating arcing or burning
- Superior electro-mechanical connections
- Locked contacts will withstand a pulling force of 1,000 lbs
- Receptacles are safety insulated for direct mounting to steel panels
- 1/3 of a turn assures a high pressure contact approaching 600 lbs. per sq. inch providing minimum resistance
- Contacts carefully machined from a high conductivity brass to a smooth sliding fit and easy locking action
- Watertight elastomeric body molded from colorfast material, color-coded for easy phase identification
- Recessed contacts protected by insulating jacket that extends beyond contact ends for safety

**Insulated Receptacles 1 1/8" (28.6mm) Threaded Stud**

	Color	Male Complete Part No.	Female Complete Part No.
1 1/8" (28.6mm) Threaded Stud	BK	E1018-1600S	E1018-1631S
	RD	E1018-1602S	E1018-1633S
Stud size 1/2"-13, maximum torque 40 ft. lbs.	GR	E1018-1604S	E1018-1635S
	WH	E1018-1605S	E1018-1636S
	BU	E1018-1606S	E1018-1637S
	BRN	E1018-1607S	E1018-1638S
	ORG	E1018-1603S	E1018-1634S
	YEL	E1018-1601S	E1018-1632S

**Insulated Receptacles 3/4" (19.1mm) Threaded Stud**

	Color	Male Complete Part No.	Female Complete Part No.
3/4" (19.1mm) Threaded Stud	BK	E1018-1600	E1018-1631
	RD	E1018-1602	E1018-1633
Stud size 1/2"-13, maximum torque 40 ft. lbs.	GR	E1018-1604	E1018-1635
	WH	E1018-1605	E1018-1636
	BU	E1018-1606	E1018-1637
	BRN	E1018-1607	E1018-1638
	ORG	E1018-1603	E1018-1634
	YEL	E1018-1601	E1018-1632

For E1018 Elastomeric, Threaded Stud Drawings, see Page F-59  
To order single packaged products add a "K" suffix to the complete part number

**Color Information:**

BK (Black), RD (Red), GR (Green), WH (White), BU (Blue), BRN (Brown), ORG (Orange), YEL (Yellow)



**Testing & Code Compliance:** CSA Certified to C22.2, no. 182.3-M1987, file no. LR13963 **Material Characteristics:** Insulator: TPE, Environmental: NEMA 3R, Temperature Rating: -40° C to 105° C

**Specifications and availability are subject to change without notice.**

**Standard Series  
E1018 Terminals**

600V AC/DC, Up to 400A Continuous  
NEMA 3R

**Standard Series E1018 Terminal**

**Features**

- Double cam principle provides a positive, vibration-proof connection
- Self-compensating for wear
- No moving contact surfaces, eliminating arcing or burning
- Superior electro-mechanical connections
- Locked contacts will withstand a pulling force of 1,000 lbs
- 1/3 of a turn assures a high pressure contact approaching 600 lbs. per sq. in. providing minimum resistance
- Contacts carefully machined from a high conductivity brass to a smooth sliding fit and easy locking action
- Watertight body molded from colorfast material, color-coded for easy phase identification
- Recessed contacts protected by insulating jacket that extends beyond contact ends for safety



E1018-575



E1018-625

**Female Terminal Connectors**

Color	Angle Style Complete Part No.	Offset Style Complete Part No.
BK	E1018-575	E1018-625
RD	E1018-577	E1018-627
GR	E1018-579	E1018-629
WH	E1018-580	E1018-630
BU	E1018-587	E1018-638
BRN	E1018-590	E1018-639
ORG	E1018-578	E1018-628
YEL	E1018-576	E1018-626

Stud hole 21/32" (16.7mm)

For E1018 Rubber Terminal Drawings, see Page F-59

To order single packaged products add a "K" suffix to the complete part number

**Color Information:**

BK (Black), RD (Red), GR (Green), WH (White), BU (Blue), BRN (Brown), ORG (Orange), YEL (Yellow)

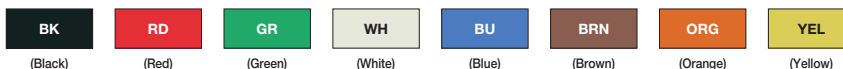

**Testing & Code Compliance:** CSA Certified to C22.2, no. 182.3-M1987, file no. LR13963 **Material Characteristics:** Body: Rubber, Environmental: NEMA 3R, Temperature Rating: -40° C to 105° C

Specifications and availability are subject to change without notice.

## Standard Series E1018 Accessories

600V AC/DC, Up to 400A Continuous  
NEMA 3R



E1018-2324



A100435-1

### Standard Series E1018 Elastomeric

#### Features

- Double cam principle provides a positive, vibration-proof connection
- Self-compensating for wear
- No moving contact surfaces, eliminating arcing or burning
- Superior electro-mechanical connections
- Locked contacts will withstand a pulling force of 1,000 lbs
- Recessed contacts protected by insulating jacket that extends beyond contact ends for safety
- 1/3 of a turn assures a high pressure contact approaching 600 lbs. per sq. in. providing minimum resistance
- Contacts carefully machined from a high conductivity brass to a smooth sliding fit and easy locking action.
- Watertight body molded from colorfast material, color-coded for easy phase identification

### Three Way Lay-Down "T" Connectors

Color	Paralleling "T" M-M-F Part No.	Tapping "T" M-F-F Part No.
BK	E1018-2324	E1018-2312
RD	E1018-2326	E1018-2314
GR	E1018-2328	E1018-2316
WH	E1018-2329	E1018-2317
BU	E1018-2348	E1018-2350
BRN	E1018-2396	E1018-2395
ORG	E1018-2327	E1018-2315
YEL	E1018-2325	E1018-2313

### Protective Caps (Not UL Listed or CSA Certified)

Color	Male Cap Part No.	Female Cap Part No.
BK	A100435-1	A100433-1
RD	A100435-5	A100433-5
GR	A100435-9	A100433-9
WH	A100435-11	A100433-11
BU	A100435-15	A100433-15
BRN	A100435-13	A100433-13
ORG	A100435-7	A100433-7
YEL	A100435-3	A100433-3

To order single packaged products add a "K" suffix to the complete part number

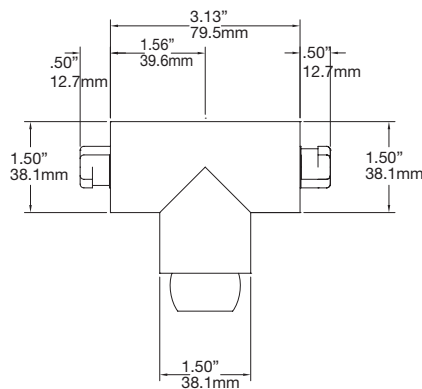

#### Color Information:

BK (Black), RD (Red), GR (Green), WH (White), BU (Blue), BRN (Brown), ORG (Orange), YEL (Yellow)



**Testing & Code Compliance:** CSA Certified to C22.2, no. 182.3-M1987, file no. LR13963 **Material Characteristics:** Insulator: TPE, Environmental: NEMA 3R, Temperature Rating: -40° C to 105° C

**Specifications and availability are subject to change without notice.**

Standard Series E-Z1018, Elastomeric, Non-Vulcanized, Double Set Screw Connection

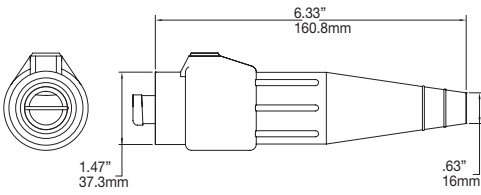

Male Connector

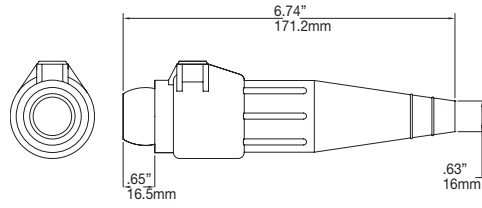

Female Connector

Standard Series E-Z1018, Elastomeric, Non-Vulcanized, Double Set Screw Connection

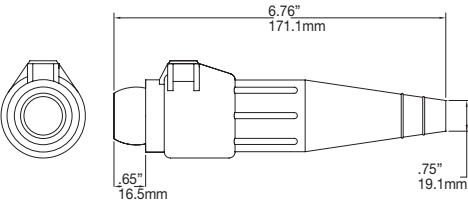

Male Connector

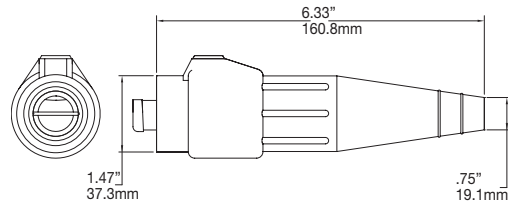

Female Connector

Standard Series E1018 Elastomeric, Double Set Screw

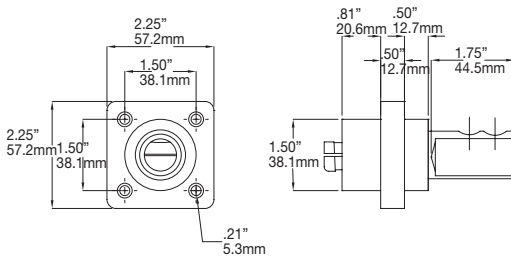

Male Receptacle

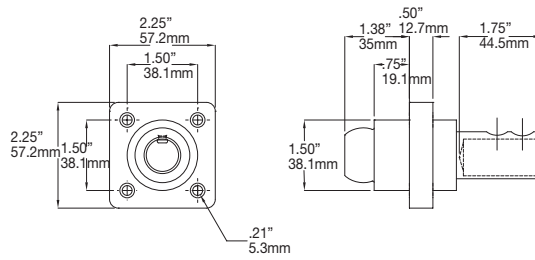

Female Receptacle

Standard Series E1018 Elastomeric, Threaded Stud

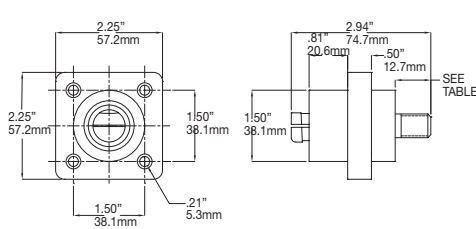

Male Receptacle

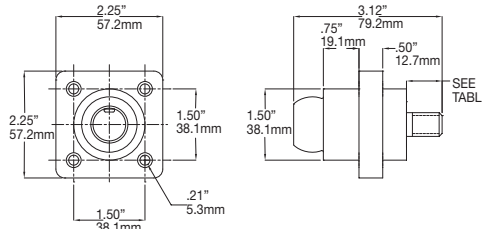

Female Receptacle

Standard Series E1018 Rubber Terminal

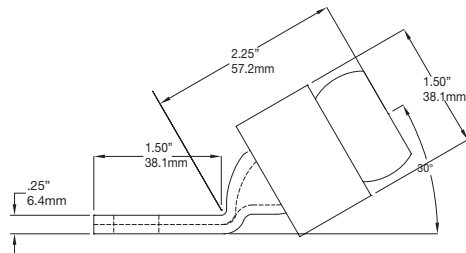
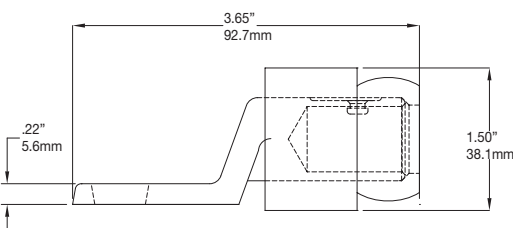

## Parts &amp; Accessories | Portable Vulcanizing Kits &amp; Presses

**Complete Vulcanizing Kits**

Cable Size	Cable O.D.	E1015 Series	E1016 Series
#8	.440	A300120-1	--
#6	.510	A300120-2	--
#4	.570	A300120-3	--
#2	.660	--	A300100-3
#1	.740	--	A300100-4
1/0	.770	--	A300100-5
2/0	.820	--	A300100-6
3/0	.870	--	A300100-7
4/0	.930	--	A300100-8

Kit contains: vulcanizing press, male and female com-a-long, cable cutter, crimp press and neoprene tape.

**Vulcanizing Presses Only**

Cable Size	Cable O.D.	E1015 series	E1016 series	E1017 series
#8	.440	A300121-1	--	--
#6	.510	A300100-2	--	--
#4	.570	A300100-3	--	--
#2	.660	--	A300103-3	--
#1	.740	--	A300103-4	--
1/0	.770	--	A300103-5	--
2/0	.820	--	A300103-6	--
3/0	.870	--	A300103-7	--
4/0	.930	--	A300103-8	--
350MCM	1.150	--	--	A300106-1
500MCM	1.310	--	--	A300106-2
750MCM	1.580	--	--	A300106-3

**Plug Molding Bushings**

Cable Size	Nominal Cable O.D.	E1015 series	E1016 series	E1017 series
#8	.440	201015-3	--	--
#6	.510	201015-15	--	--
#4	.570	201015-18	--	--
#2	.660	--	200895-20	--
#1	.740	--	200895-21	--
1/0	.770	--	200895-22	--
2/0	.820	--	200895-23	--
3/0	.870	--	200895-24	--
4/0	.930	--	200895-17	--
350MCM	1.150	--	--	200006-3
500MCM	1.310	--	--	200006-6
750MCM	1.580	--	--	200006-8

Specifications and availability are subject to change without notice.

## Parts &amp; Accessories | Molding Press Parts &amp; Vulcanizing Accessories

## Molding Press Parts And Vulcanizing Accessories

Part No.	Description
	All Mold Kits and Presses
A400001*	E1016/E0400 Assembly Tool
319735-1	Neoprene Vulcanizing Tape, 1.5" x 32" roll
100566-1	Mold Press Thermostat
A100632*	Tool for removing contacts from insulators
100826-3	Mold Press Power On-Off Switch
A200020-1	COM-A-LONG for pulling male contact in E1015 Series
A200020-2	COM-A-LONG for pulling female contact in E1015 Series
100827-3	Mold Press Pilot Light - red, complete with wired socket
200704-2	Cartridge Heater - 350-750 MCM Molds
200704-3	Cartridge Heater - #2-4/0 Molds
A100072*	Cable Cutter - #2-4/0 Cable
A200020-3*	COM-A-LONG for pulling male contact in E1012, E1016, E1018 and E0400 Series
A200020-4*	COM-A-LONG for pulling female contact in E1012, E1016, E1018 and E0400 Series
A200020-5	COM-A-LONG for pulling male contact in E1017 Series
A200020-6	COM-A-LONG for pulling female contact in E1017 Series
A101208*	2 oz. tube silicon grease for lubricating synthetic rubber insulators

## E1015 &amp; E1016 Series Crimping Nest &amp; Presses

Cable Size	Crimping Nests Part No.	Crimping Presses
#8	100514-1	A200914-1
#4-6	100514-2	A200914-2
#1-2	100514-3	A200914-3
1/0-2/0	100514-4	A200914-4
3/0	100514-5	A200914-5
4/0	100514-6	A200914-6

Gage block for calibrating crimper: #100891

## Other Accessories

Connector Series No.	Set Screw	Copper Shim	Quantity	Pressure Pad	Retaining Wire
E1010 All	100012-25	A100400-1	25	N/A	100573-1
E1012-61 & 62	100012-7	A100400-3	20	100575	100573-1
E1012 Single Set-Screw	100012-18	A100400-3	20	N/A	100573-1
E1016 Single Set-Screw	100012-18	A100400-3	20	N/A	100573-1
E1017 Double Set-Screw	100012-5	100400-9	1	N/A	100573-2
E1018 Single Set-Screw	100012-18	A100400-3	20	N/A	100573-1
E1012 Double Set-Screw	100012-18	A100400-4	20	101214	100573-1
E1016 Double Set-Screw	100012-18	A100400-4	20	101214	100573-1

\*See Page 73 for part reference photo

Specifications and availability are subject to change without notice.

## Quick and Safe Power Distribution Connection System

Designed to meet Article 520-53 Section K and Article 530-22 Section A (NEC) Standards, the built-in safety features require the user to connect or disconnect each plug in sequence. Protective receptacle covers cannot be raised until the preceding plug is locked into position

### Applications

- Posi-Lok™ power distribution panels bring a new level of safety to electrical power applications
- Posi-Lok™ systems utilize single conductor cable that can be used to full amperage capability without the need to derate like multi-conductor solutions
- Posi-Lok™ products are ideal for disaster relief, temporary power, standby emergency power and power distribution applications

### Specifications

#### Electrical Ratings

- 600 Volts
- 200 Amps Continuous (E0200)
- 400 Amps Continuous (E0400)

#### Temperature Ratings

- -40° C to 105° C

#### Materials

- Cable Sizes: #2-4/0
- Insulator: Elastomeric
- Contact: Copper

#### Certifications

- UL Listed: E67181
- CSA Certified: LR13963-48

### Features

- 1 Safe, sequential interlock ensures ground mates first and breaks last
- 2 Limit switch capabilities



- 3 Reliable Posi-Lok, Cross-Phase Protection System ensures phase integrity
- 4 UL Listed and CSA Certified
- 5 Quick and easy installation - Panels can be mounted into a standard 19-inch rack
- 6 Lockout-Tagout compatible for safety and security
- 7 Shatter-resistant insulators and polarizing shells provide long-lasting, durable connectors

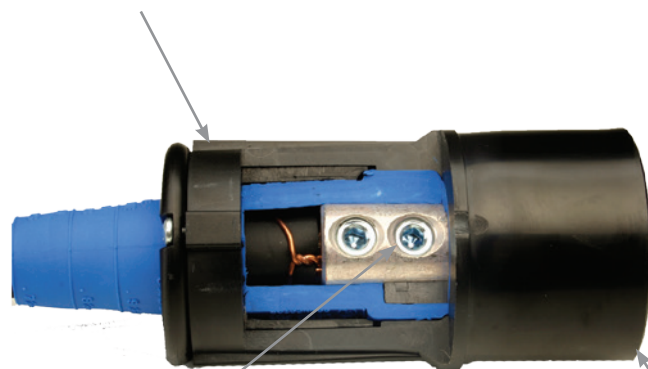

- 8 Double set screw termination for added strength and quick installation (crimp also available)
- 9 Plugs are uniquely keyed and color-coded to eliminate cross-phasing

Cut-Away View of E0400 Male Plug

**Quick and Efficient Standby and Emergency Power**

Posi-Lok™ distribution panels use lightweight, single conductor cables to provide the means for hurried personnel to quickly and safely connect and disconnect power systems without having to use any tools



**Posi-Lok™ Connectors**

Now there's no need to haul around huge, multi-conductor cables. Posi-Lok Power Distribution Systems let you use lighter, single conductor cables rated at higher amperages

Posi-Lok™ plugs feature recessed electrical contacts that are protected by shatter-resistant insulators and impact-resistant molded sleeves

More than 25 years of field testing has proven that the unique elastomeric tapered insulator allows maximum flexing with minimum breakage. There are no metal clamps or grommets to cause cable failure

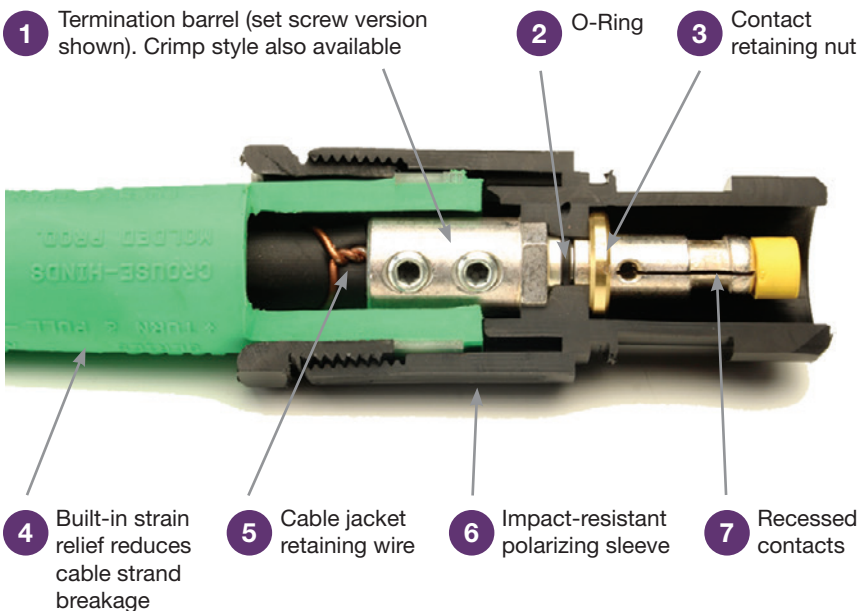

Cut-Away View of E0200 Male Plug



The same plugs that connect to panels also connect to each other so that you can use long runs of cable. Polarity is assured because each plug is uniquely keyed and color-coded for easy, positive connecting



## Posi-Lok™ Plugs and Panels E0200 Series

Cable Size #2 AWG-2/0  
600V AC/DC, Up to 200A Continuous



### Posi-Lok™ E0200 Series Female Panels and Male Plugs

#### Features

- Designed to meet Article 520-53 Section K and Article 530-22 Section A (NEC) standards
- Sequential interlock system requires the user to connect and disconnect each plug in sequence
- Polarized plugs and panels eliminate the possibility of cross-phasing
- Built-in strain relief reduces cable strain
- Proven Cam-Lok double cam principle provides a positive, vibration-proof connection
- No moving contact surfaces, eliminating arching or burning of contacts
- Recessed contacts protected by insulating jacket that extends beyond contact ends for safety

#### Female Panel Part Numbers

Receptacles Per Panel	Female Panels	Cover Color Code
3	E0200-1685	GR, WH, BK
4	E0200-1686-NN	GR, BK, RD, BU
4	E0200-1696	GR, WH, BK, RD
4	E0200-1892-NN	GR, BRN, ORG, YEL
5	E0200-1687	GR, WH, BK, RD, BU
5	E0200-1890	GR, WH, BRN, ORG, YEL
6	E0200-1885	GR, WH, BK, RD, BU

Add "LS" suffix to end of part number to order panels with a limit switch. Available on last position only.  
Example: E0200-1687LS. Limit switch ratings are 5A, 250V/AC.  
**Plugs must be ordered separately. See below.**

#### Male Plugs

Termination	Position	Male Complete Part No.	Male Contact Only Part No.	Male Insulator Polarizing Shell Part No.
Crimp	GR	E0200-141	A201293-5	A201315-3
	WH	E0200-142	A201293-5	A201315-2
	BK	E0200-143	A201293-5	A201315-1
	RD	E0200-144	A201293-5	A201315-5
	BU	E0200-145	A201293-5	A201315-4
	BRN	E0200-147	A201293-5	A201315-9
	ORG	E0200-148	A201293-5	A201315-10
	YEL	E0200-149	A201293-5	A201315-8
	Double Set Screw	GR	E0200-181	A201293-1
WH		E0200-182	A201293-1	A201315-2
BK		E0200-183	A201293-1	A201315-1
RD		E0200-184	A201293-1	A201315-5
BU		E0200-185	A201293-1	A201315-4
BRN		E0200-199	A201293-1	A201315-9
ORG		E0200-195	A201293-1	A201315-10
YEL		E0200-192	A201293-1	A201315-8

Male Plug Assembled length is 8 3/4"

#### Color Information:

BK (Black), RD (Red), GR (Green), WH (White), BU (Blue), BRN (Brown), ORG (Orange), YEL (Yellow)



**Testing & Code Compliance:** Listed to UL498, file no. E67181, CSA Certified to C22.2, no. 182.3-M1987, file no. LR13963  
**Material Characteristics:** Insulator: TPE, Polarizing Shell: Thermoplastic, Temperature Rating: -40° C to 105° C

Specifications and availability are subject to change without notice.

## Posi-Lok™ Plugs and Panels E0200 Series

Cable Size #2 AWG-2/0  
600V AC/DC, Up to 200A Continuous

### Posi-Lok™ E0200 Series Male Panels and Female Plugs

#### Features

- Designed to meet Article 520-53 Section K and Article 530-22 Section A (NEC) standards
- Sequential interlock system requires the user to connect and disconnect each plug in sequence
- Polarized plugs and panels eliminate the possibility of cross-phasing
- Built-in strain relief reduces cable strain
- Proven Cam-Lok double cam principle provides a positive, vibration-proof connection
- No moving contact surfaces, eliminating arching or burning of contacts
- Recessed contacts protected by insulating jacket that extends beyond contact ends for safety

### Male Panel Part Numbers

Receptacles Per Panel	Female Panels	Cover Color Code
3	E0200-1660	GR, WH, BK
4	E0200-1661-NN	GR, BK, RD, BU
4	E0200-1672	GR, WH, BK, RD
4	E0200-1893-NN	GR, BRN, ORG, YEL
5	E0200-1662	GR, WH, BK, RD, BU
5	E0200-1891	GR, WH, BRN, ORG, YEL
6	E0200-1860	GR, WH, BK, RD, BU

Add "LS" suffix to end of part number to order panels with a limit switch. Available on last position only.  
Example: E0200-1682LS. Limit switch ratings are 5A, 250V/AC.  
**Plugs must be ordered separately. See below.**

### Female Plugs

Termination	Position	Female Complete Part No.	Female Contact Only Part No.	Female Insulator Polarizing Shell Part No.
Crimp	GR	E0200-241	A201292-5	A201315-27
	WH	E0200-242	A201292-5	A201315-26
	BK	E0200-243	A201293-5	A201315-25
	RD	E0200-244	A201292-5	A201315-29
	BU	E0200-245	A201292-5	A201315-28
	BRN	E0200-247	A201292-5	A201315-33
	ORG	E0200-248	A201292-5	A201315-34
	YEL	E0200-249	A201292-5	A201315-32
Double Set Screw	GR	E0200-281	A201292-1	A201315-27
	WH	E0200-282	A201292-1	A201315-26
	BK	E0200-283	A201292-1	A201315-25
	RD	E0200-284	A201292-1	A201315-29
	BU	E0200-285	A201292-1	A201315-28
	BRN	E0200-288	A201292-1	A201315-33
	ORG	E0200-289	A201292-1	A201315-34
	YEL	E0200-286	A201292-1	A201315-32

Female Plug Assembled length is 8 3/4"



#### Color Information:

BK (Black), RD (Red), GR (Green), WH (White), BU (Blue), BRN (Brown), ORG (Orange), YEL (Yellow)



**Testing & Code Compliance:** Listed to UL498, file no. E67181, CSA Certified to C22.2, no. 182.3-M1987, file no. LR13963  
**Material Characteristics:** Insulator: TPE, Polarizing Shell: Thermoplastic, Temperature Rating: -40° C to 105° C

Specifications and availability are subject to change without notice.

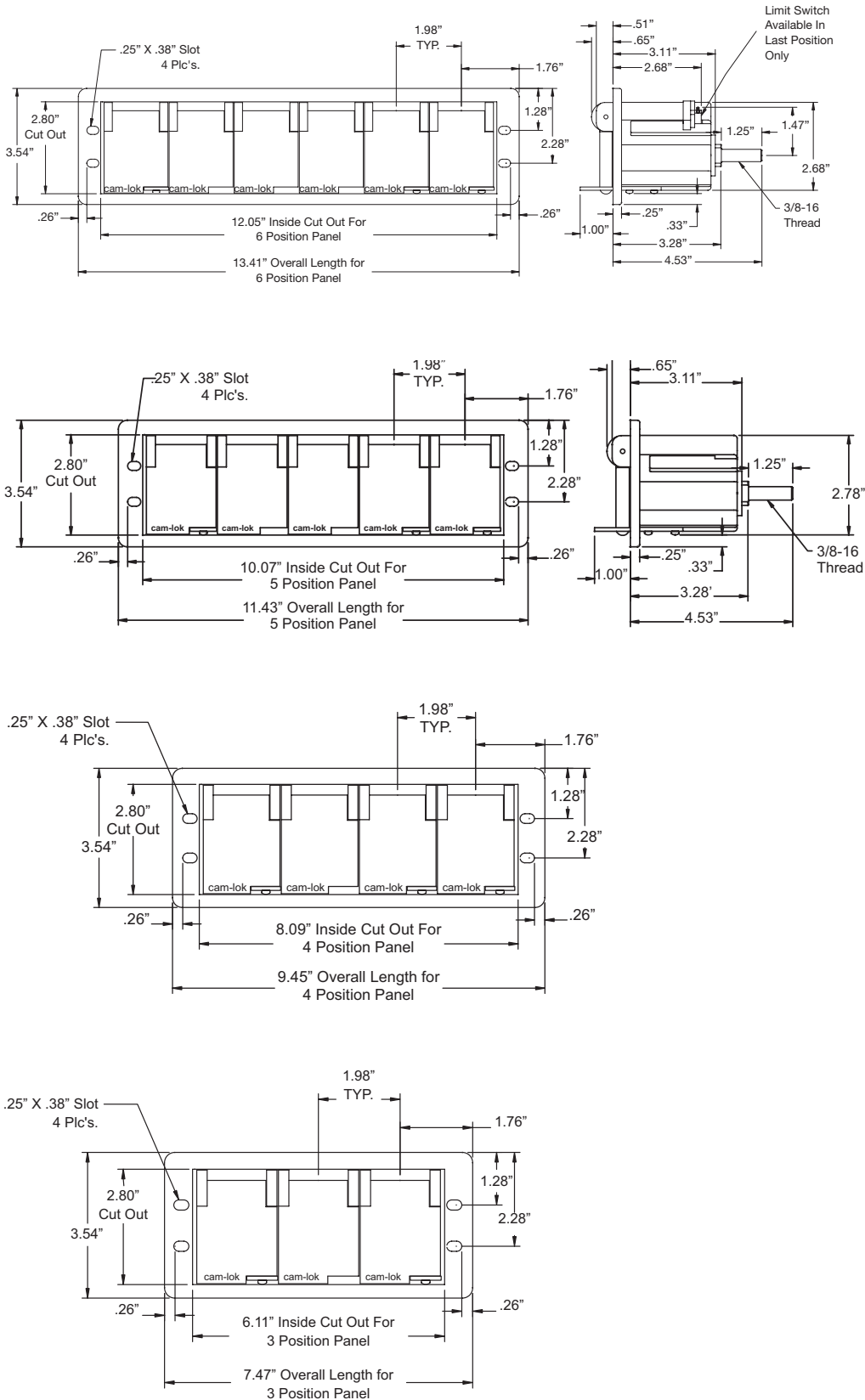
**Cut-Out & Product Dimensions**

All measurements are in inches.

Specifications and availability are subject to change without notice.



**Posi-Lok™ Plugs and Panels**

**Technical Information**

- Ampacity is based on cable size or continuous rating, whichever is less
- Panel does not include enclosure or breakers, Posi-Lok™ system must be installed per local and national standards
- Panel receptacles have lock washers, flat washers and jam nuts included
- Plugs and panels have silver plated copper contacts

**Posi-Lok™ E0200 Ratings**

Cable Size	Amperage Rating	Voltage Rating
#2 AWG	190 AMPS	600 V AC
#1 AWG	200 AMPS	600 V AC
1/0	200 AMPS	600 V AC
2/0	200 AMPS	600 V AC

**Posi-Lok™ E0400 Ratings**

Cable Size	Amperage Rating	Voltage Rating
#2 AWG	190 AMPS	600 V AC
#1 AWG	220 AMPS	600 V AC
1/0	260 AMPS	600 V AC
2/0	300 AMPS	600 V AC
3/0	350 AMPS	600 V AC
4/0	400 AMPS	600 V AC



**Posi-Lok™ Panels  
E0400 Series**Cable Size #2 AWG - 4/0  
600V AC/DC, Up to 400A Continuous**Posi-Lok™ E0400 Series Male Plugs, Crimp & Double Set Screw****Features**

- Designed to meet Article 520-53 Section K and Article 530-22 Section A (NEC) standards
- Sequential interlock system requires the user to connect and disconnect each plug in sequence
- Polarized panels eliminate the possibility of cross-phasing
- Proven Cam-Lok double cam principle provides a positive, vibration-proof connection
- No moving contact surfaces, eliminating arching or burning of contacts
- Recessed contacts protected by insulating jacket that extends beyond contact ends for safety

**Male Panel Part Numbers**

Receptacles Per Panel	Female Panels	Cover Color Code
3	E0400-1685	GR, WH, BK
4	E0400-1686-NN	GR, BK, RD, BU
4	E0400-1696	GR, WH, BK, RD
4	E0400-1883-NN	GR, BRN, ORG, YEL
5	E0400-1687	GR, WH, BK, RD, BU
5	E0400-1702	GR, WH, BRN, ORG, YEL
6	E0400-1885	GR, WH, BK, RD, BU

Add "LS" suffix to end of part number to order panels with a limit switch.

Available on all positions. Consult factory.

Limit switch ratings are [125, 250, 480V/AC, 15A], [125V/DC, .5A], [250V/DC, .25A]

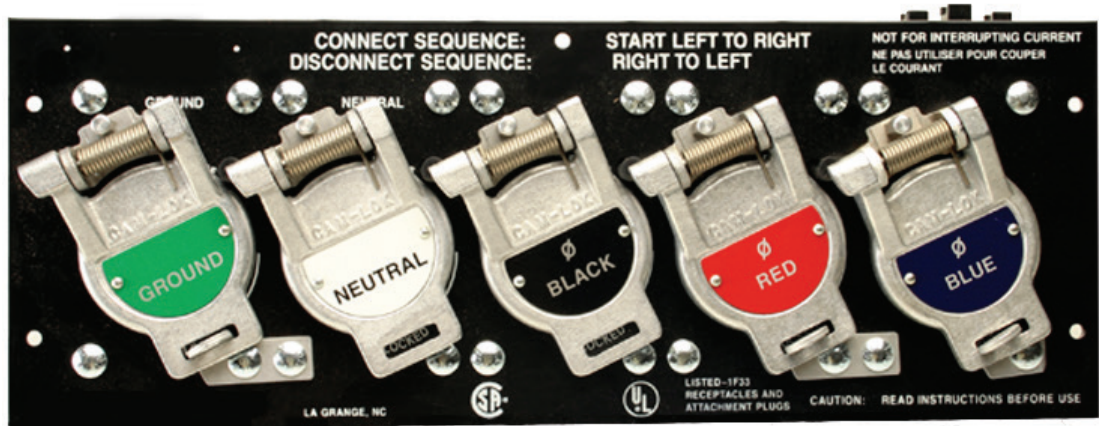
**Plugs must be ordered separately.****Color Information:**

BK (Black), RD (Red), GR (Green), WH (White), BU (Blue), BRN (Brown), ORG (Orange), YEL (Yellow)

**Testing & Code Compliance:** Listed to UL498, file no. E67181, CSA Certified to C22.2, no. 182.3-M1987, file no. LR13963**Material Characteristics:** Panel: Steel, Temperature Rating: -40° C to 105° C

Specifications and availability are subject to change without notice.

**Posi-Lok™ Plugs**  
**E0400 Series**

Cable Size #2 AWG - 4/0  
600V AC/DC, Up to 400A Continuous

**Posi-Lok™ E0400 Series Male Plugs, Crimp & Double Set Screw**

**Features**

- Designed to meet Article 520-53 Section K and Article 530-22 Section A (NEC) standards
- Polarized plugs eliminate the possibility of cross-phasing
- Built-in strain relief reduces cable strain
- Proven Cam-Lok double cam principle provides a positive, vibration-proof connection
- No moving contact surfaces, eliminating arcing or burning of contacts
- Recessed contacts protected by insulating jacket that extends beyond contact ends for safety

**Male Plugs**

Termination	Position	Male Complete Part No.	Male Contact Only Part No.	Male Insulator Part No.	Polarizing Shell Part No.
Crimp 1/0-2/0	GR	E0400-141	A201271-2	3336200-1	A201263-6
	WH	E0400-142	A201271-2	3336200-2	A201263-7
	BK	E0400-143	A201271-2	3336200-3	A201263-8
	RD	E0400-144	A201271-2	3336200-4	A201263-9
	BU	E0400-145	A201271-2	3336200-5	A201263-10
	BRN	E0400-146	A201271-2	3336200-6	A201263-29
	ORG	E0400-147	A201271-2	3336200-7	A201263-30
	YEL	E0400-148	A201271-2	3336200-8	A201263-31
Crimp 3/0-4/0	GR	E0400-161	A201271-1	3336200-9	A201263-1
	WH	E0400-162	A201271-1	3336200-10	A201263-2
	BK	E0400-163	A201271-1	3336200-11	A201263-3
	RD	E0400-164	A201271-1	3336200-12	A201263-4
	BU	E0400-165	A201271-1	3336200-13	A201263-5
	BRN	E0400-166	A201271-1	3336200-14	A201263-26
	ORG	E0400-167	A201271-1	3336200-15	A201263-23
	YEL	E0400-168	A201271-1	3336200-16	A201263-25
Double Set Screw #2-2/0	GR	E0400-151	A201283-3	3336200-1	A201263-6
	WH	E0400-152	A201283-3	3336200-2	A201263-7
	BK	E0400-153	A201283-3	3336200-3	A201263-8
	RD	E0400-154	A201283-3	3336200-4	A201263-9
	BU	E0400-155	A201283-3	3336200-5	A201263-10
	BRN	E0400-156	A201283-3	3336200-6	A201263-29
	ORG	E0400-157	A201283-3	3336200-7	A201263-30
	YEL	E0400-158	A201283-3	3336200-8	A201263-31
Double Set Screw 3/0-4/0	GR	E0400-181	A201283-1	3336200-9	A201263-1
	WH	E0400-182	A201283-1	3336200-10	A201263-2
	BK	E0400-183	A201283-1	3336200-11	A201263-3
	RD	E0400-184	A201283-1	3336200-12	A201263-4
	BU	E0400-185	A201283-1	3336200-13	A201263-5
	BRN	E0400-199	A201283-1	3336200-14	A201263-26
	ORG	E0400-195	A201283-1	3336200-15	A201263-23
	YEL	E0400-192	A201283-1	3336200-16	A201263-25

Male Plug Assembled length is 7 1/4"



**Testing & Code Compliance:** Listed to UL498, file no. E67181, CSA Certified to C22.2, no. 182.3-M1987, file no. LR13963  
**Material Characteristics:** Insulator: TPE, Polarizing Shell: Thermoplastic, Temperature Rating: -40° C to 105° C  
**Specifications and availability are subject to change without notice.**

**Posi-Lok™ Plugs & Panels E0400 Series**Cable Size #2 AWG - 4/0  
600V AC/DC, Up to 400A Continuous**Posi-Lok™ E0400 Series Male Panels****Features**

- Designed to meet Article 520-53 Section K and Article 530-22 Section A (NEC) standards
- Sequential interlock system requires the user to connect and disconnect each plug in sequence
- Polarized panels eliminate the possibility of cross-phasing
- Proven Cam-Lok double cam principle provides a positive, vibration-proof connection
- No moving contact surfaces, eliminating arching or burning of contacts
- Recessed contacts protected by insulating jacket that extends beyond contact ends for safety

**Male Panel Part Numbers**

Receptacles Per Panel	Male Panels	Cover Color Code
3	E0400-1660	GR, WH, BK
4	E0400-1661-NN	GR, BK, RD, BU
4	E0400-1672	GR, WH, BK, RD
4	E0400-1862-NN	GR, BRN, ORG, YEL
5	E0400-1662	GR, WH, BK, RD, BU
5	E0400-1703	GR, WH, BRN, ORG, YEL
6	E0400-1860	GR, WH, BK, RD, BU

Add "LS" suffix to end of part number to order panels with a limit switch.  
Available on all positions. Consult factory.  
Limit switch ratings are [125, 250, 480V/AC, 15A], [125V/DC, .5A], [250V/DC, .25A]  
**Plugs must be ordered separately.**

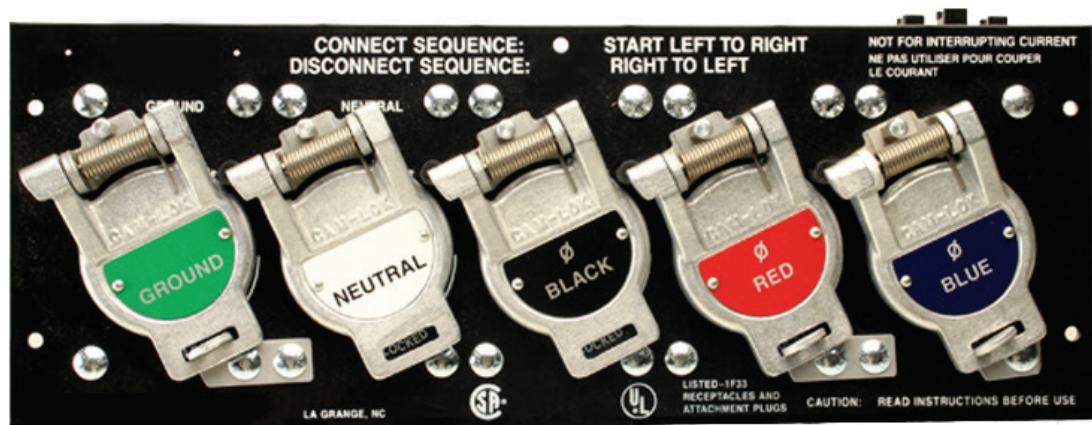
**Color Information:**

BK (Black), RD (Red), GR (Green), WH (White), BU (Blue), BRN (Brown), ORG (Orange), YEL (Yellow)



**Testing & Code Compliance:** Listed to UL498, file no. E67181, CSA Certified to C22.2, no. 182.3-M1987, file no. LR13963  
**Material Characteristics:** Insulator: TPE, Temperature Rating: -40° C to 105° C

Specifications and availability are subject to change without notice.

**Posi-Lok™ Plugs & Panels E0400 Series**

Cable Size #2 AWG - 4/0  
600V AC/DC, Up to 200A Continuous

**Posi-Lok™ E0400 Series Female Plugs, Crimp & Double Set Screw**

**Features**

- Designed to meet Article 520-53 Section K and Article 530-22 Section A (NEC) standards
- Polarized plugs eliminate the possibility of cross-phasing
- Proven Cam-Lok double cam principle provides a positive, vibration-proof connection
- No moving contact surfaces, eliminating arching or burning of contacts
- Recessed contacts protected by insulating jacket that extends beyond contact ends for safety
- Built-in strain relief reduces cable strain

**Female Plugs**

Termination	Position	Female Complete Part No.	Female Contact Only Part No.	Female Insulator Part No.	Polarizing Shell Part No.
Crimp 1/0-2/0	GR	E0400-241	A201272-4	3336199-1	A201262-6
	WH	E0400-242	A201272-4	3336199-2	A201262-7
	BK	E0400-243	A201272-4	3336199-3	A201262-8
	RD	E0400-244	A201272-4	3336199-4	A201262-9
	BU	E0400-245	A201272-4	3336199-5	A201262-10
	BRN	E0400-246	A201272-4	3336199-6	A201262-27
	ORG	E0400-247	A201272-4	3336199-7	A201262-28
	YEL	E0400-248	A201272-4	3336199-8	A201262-29
Crimp 3/0-4/0	GR	E0400-261	A201272-2	3336199-9	A201262-1
	WH	E0400-262	A201272-2	3336199-10	A201262-2
	BK	E0400-263	A201272-2	3336199-11	A201262-3
	RD	E0400-264	A201272-2	3336199-12	A201262-4
	BU	E0400-265	A201272-2	3336199-13	A201262-5
	BRN	E0400-266	A201272-2	3336199-14	A201262-26
	ORG	E0400-267	A201272-2	3336199-15	A201262-23
	YEL	E0400-268	A201272-2	3336199-16	A201262-25
Double Set Screw #2-2/0	GR	E0400-251	A201284-3	3336199-1	A201262-6
	WH	E0400-252	A201284-3	3336199-2	A201262-7
	BK	E0400-253	A201284-3	3336199-3	A201262-8
	RD	E0400-254	A201284-3	3336199-4	A201262-9
	BU	E0400-255	A201284-3	3336199-5	A201262-10
	BRN	E0400-256	A201284-3	3336199-6	A201262-27
	ORG	E0400-257	A201284-3	3336199-7	A201262-28
	YEL	E0400-258	A201284-3	3336199-8	A201262-29
Double Set Screw 3/0-4/0	GR	E0400-281	A201284-1	3336199-9	A201262-1
	WH	E0400-282	A201284-1	3336199-10	A201262-2
	BK	E0400-283	A201284-1	3336199-11	A201262-3
	RD	E0400-284	A201284-1	3336199-12	A201262-4
	BU	E0400-285	A201284-1	3336199-13	A201262-5
	BRN	E0400-299	A201284-1	3336199-14	A201262-26
	ORG	E0400-295	A201284-1	3336199-15	A201262-23
	YEL	E0400-292	A201284-1	3336199-16	A201262-25

Female Plug Assembled length is 7 1/4"



**Testing & Code Compliance:** Listed to UL498, file no. E67181, CSA Certified to C22.2, no. 182.3-M1987, file no. LR13963  
**Material Characteristics:** Insulator: TPE, Polarizing Shell: Thermoplastic, Temperature Rating: -40° C to 105° C  
**Specifications and availability are subject to change without notice.**

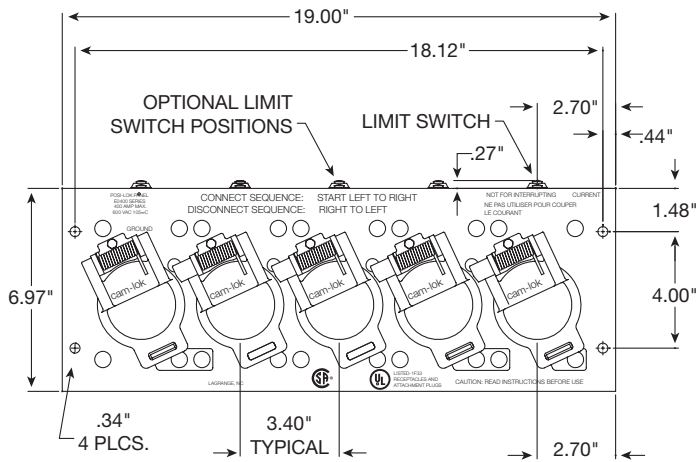

**Cut-Out & Product Dimensions/Caps**

Panel with limit switch mounting dimensions

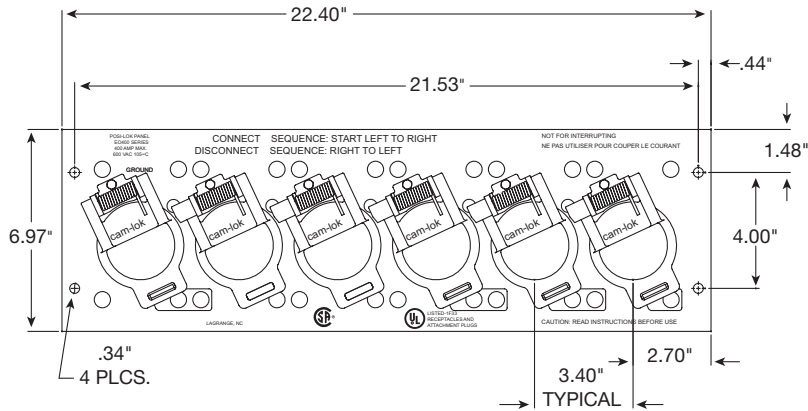
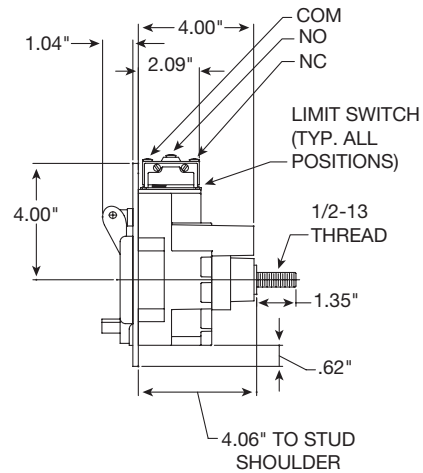

Panel without limit switch mounting dimensions

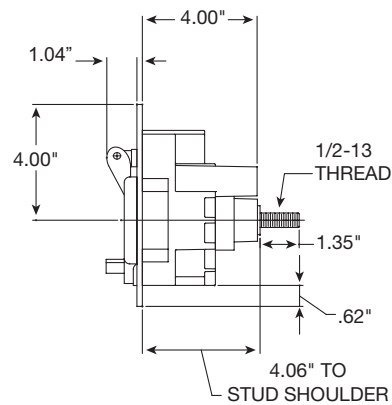
**Protective Plug Caps**

Part No.	Description
A100601-17	Cap for male E0400
A100602-17	Cap for female E0400
A201318-1	Cap for male E0200
A201319-1	Cap for female E0200

Specifications and availability are subject to change without notice.

**Posi-Lok™ Tools & Accessories** | Replacement Parts,  
Crimping Nest & Presses

**Molding Press Parts And Vulcanizing Accessories**

Part No.	Description
A400001	Assembly Tool (E1016 & E0400 Only)
A100632	Tool for removing contacts from insulators
A100072	Cable Cutter - #2 - 4/0 Cable
201310	Insulator holding bracket
A201303	Assembly tool for 200A plugs
A200020-3	COM-A-LONG for pulling male contact
A200020-4	COM-A-LONG for pulling female contact
A101208	2 oz. tube silicon grease for lubricating mating end of synthetic rubber insulators

**Crimping Nest & Presses**

Cable Size	Crimping Nests Part No.	Crimping Presses
#2-#1	100514-3	A200914-3
1/0-2/0	100514-4	A200914-4
3/0	100514-5	A200914-5
4/0	100514-6	A200914-6

**Other Accessories**

Connector Series No.	Set Screw	Copper Shim	Pressure Pad	Retaining Wire
E0200	100012-33	100400-5	N/A	100573-1
E0400	100012-18	100400-8	101214	100573-1

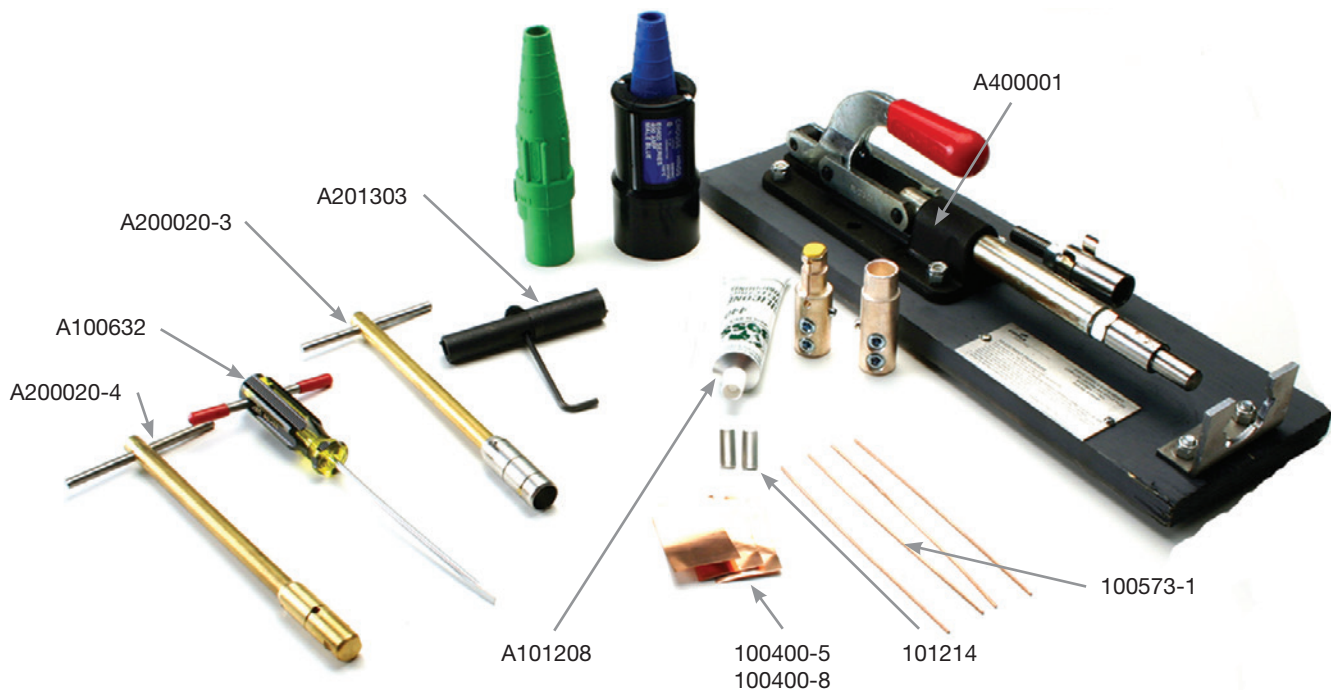

Specifications and availability are subject to change without notice.