

Section C

CONTROLS INDEX



D2C Series
DuraTech Control Stations2 - 5



D2C Series
Dimensional Data6 - 7



CS Series
CONSPEC Control Stations8 - 10



CS Series
Dimensional Data
Catalog Logic11



FXCS Series
Seal-X Factory
Sealed Control Stations12 - 17



FXB Series
Seal-X Splice Boxes13



FXCS Series
Seal-X Factory Sealed
Cover Assemblies14 - 17



XCS/XS/SWB Series
Control Stations
External Sealing Required18 - 25



SWB Series
Device Boxes19



SWB Series
Conduit Opening Data20



XCS Series
Blank Covers26



FXCS/XCS Series
Accessories, Replacement Parts26 - 27



XS Series
Tumbler Switch28



XAL/XAS Series
Fire Alarm Stations29



Factory Sealed Contact Block
1N.O./1N.C.

Class I, Div. 2, Groups A,B,C,D
Class I, Zone 2, Groups IIC, IIB, IIA
NEMA 3, 4, 4X, 7 (Div.2)



FEATURES-SPECIFICATIONS



Applications

Hazardous and corrosive environments such as refineries, chemical plants, water treatment and bio gas plants, and wherever a combustible gas-air mixture may occur.

Features

- Enclosures of rugged polyester resin and gasketed for NEMA 4X hose down protection
- Factory sealed contacts rated for heavy duty NEMA A600/Q300 explosion-protected operation
- No external seals required for most applications
- Comprehensive selection of control operators including:
 - Push buttons (standard or mushroom caps) with momentary & maintained action for multiple functions or emergency stop
 - Rotary selector switches for maintained or momentary operation
 - Pilot lights (LED as standard) in multiple voltages and colors
- Options for various enclosures entry types and legend plates

PRODUCT LINE OVERVIEW

ASSEMBLIES



One device



Two devices



Three devices

CONTROL DEVICES

Push Button

Shrouded or mushroom style

Maintained push-pull or twist-release button



Control Switch

Multiple position rotary maintained or momentary action



Pilot Light

Full voltage, resistor or transformer and multi-voltage LED types



ENCLOSURES



ENTRIES AND ACCESSORIES



Hub with Grounding locknut



Legend Plates



Hole Plug



Lockouts



KILLARK®



D2CG2B2



D2CG2MMR3



D2CG2S3C3



D2CG2B7



D2CG8B15

The control stations on this page are the most commonly used configurations, including combinations of push buttons, pilot lights and selector switches. See the following pages for components to configure custom stations.

FEATURES-SPECIFICATIONS

ONE DEVICE, DEAD END^①										
Single Push Button (Momentary Contact)										
Complete Units (Box & Cover)	NPT SIZE	DIAGRAM	COLOR	LEGEND ^②						
D2CG2B1	3/4"		GREEN	START						
D2CG2B2			RED	STOP						
D2CG2B3			BLACK	BLANK						
Push-Pull Mushroom Button (Maintained Contact)										
D2CG2MMR3	3/4"		RED	EMERGENCY STOP						
Pilot Light (120V AC Light Emitting Diode Type)										
D2CG2B24CL	3/4"		CLEAR	BLANK						
D2CG2B24GL			GREEN	BLANK						
D2CG2B24RL			RED	BLANK						
D2CG2B24BL			BLUE	BLANK						
D2CG2B24AL			AMBER	BLANK						
D2CG2B24WL	WHITE	BLANK								
2 Position Rotary Selector Switch (Maintained Contact)										
D2CG2S2A3	3/4"	<table border="0"> <tr> <td>LEFT</td> <td>DIAGRAM</td> <td>RIGHT</td> </tr> <tr> <td></td> <td>—</td> <td></td> </tr> </table>	LEFT	DIAGRAM	RIGHT		—		OFF - ON	
LEFT	DIAGRAM	RIGHT								
	—									
3 Position Rotary Selector Switch (Maintained Contact)										
D2CG2S3C3	3/4"	<table border="0"> <tr> <td></td> <td></td> <td></td> </tr> </table>				HAND-OFF-AUTO				

TWO DEVICES, DEAD END^①				
Two Push Buttons (Both Momentary Contact)				
Complete Units (Box & Cover)	NPT SIZE	DIAGRAM	COLOR	LEGEND ^②
D2CG2B4	3/4"		GREEN - RED	START - STOP
D2CG2B7			BLACK - BLACK	BLANK
Pilot Light (120V AC Light Emitting Diode Type) and Push Button (Momentary Contact)				
D2CG2B13	3/4"		RED LENS, BLACK BUTTON	BLANK

THREE DEVICES, DEAD END^①				
Pilot Light (120V AC Light Emitting Diode Type) and two push buttons (Both Momentary Contact)				
Complete Units (Box & Cover)	NPT SIZE	DIAGRAM	COLOR	LEGEND ^②
D2CG8B15	3/4"		RED LENS, GREEN & RED BUTTONS	BLANK, START, STOP
Three Push Buttons (Each Momentary Contact)				
D2CG8B9	3/4"		GREEN, RED & BLACK BUTTONS	START, STOP, BLANK

^①For 3/4" FEED-THRU, change G2 or G8 in catalog number to G5. Example D2CG2B1 becomes D2CG5B1. For other hub sizes, see page C4.

^②Specify pilot light lens marking or blank button marking if required.

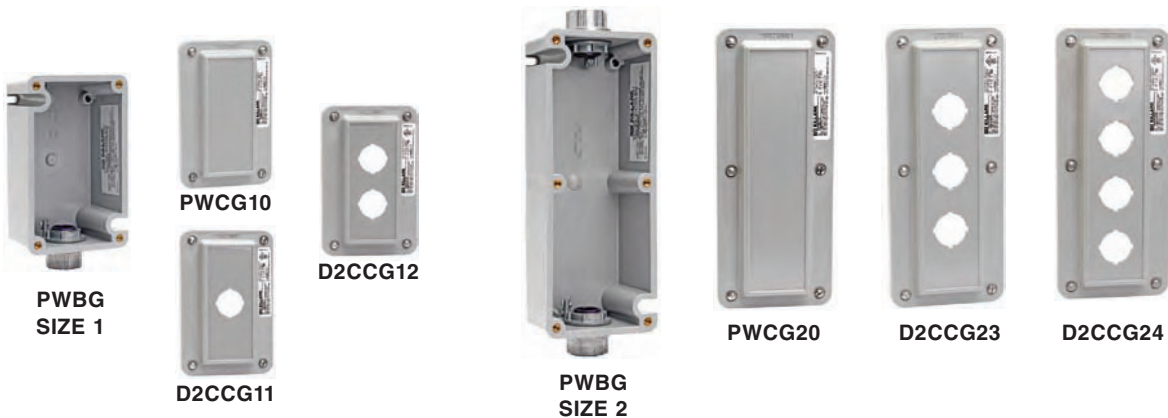

FEATURES-SPECIFICATIONS

SIZE 1 BOXES	
Catalog Number	Description
PWBG0	Blank - No Entries
PWBG1	w/1/2" NPT hub, dead end
PWBG2	w/3/4" NPT hub, dead end
PWBG3	w/1" NPT hub, dead end
PWBG4	w/1/2" NPT hubs, feed thru
PWBG5	w/3/4" NPT hubs, feed thru
PWBG6	w/1" NPT hubs, feed thru
PWBG25	w/clearance hole, 1/2" NPS
PWBG26	w/clearance hole, 3/4" NPS
PWBG27	w/clearance hole, 1" NPS
PWBG37	w/clearance hole, M20
PWBG38	w/clearance hole, M25
PWBG39	w/clearance hole, M32

SIZE 1 COVERS	
Catalog Number	Description
PWCG10	Blank-no device openings
D2CCG11	w/1 device opening 30mm
D2CCG12	w/2 device openings 30mm

SIZE 2 BOXES	
Catalog Number	Description
PWBG00	Blank - No Entries
PWBG7	w/1/2" NPT hub, dead end
PWBG8	w/3/4" NPT hub, dead end
PWBG9	w/1" NPT hub, dead end
PWBG10	w/1/2" NPT hubs, feed thru
PWBG11	w/3/4" NPT hubs, feed thru
PWBG12	w/1" NPT hubs, feed thru
PWBG31	w/clearance hole, 1/2" NPS
PWBG32	w/clearance hole, 3/4" NPS
PWBG33	w/clearance hole, 1" NPS
PWBG43	w/clearance hole, M20
PWBG44	w/clearance hole, M25
PWBG45	w/clearance hole, M32

SIZE 2 COVERS	
Catalog Number	Description
PWCG20	Blank-no device openings
D2CG23	w/3 device openings 30mm
D2CG24*	w/4 device openings 30mm

* Space restrictions may apply for feed thru conduit entries.

ENTRY FITTINGS** & ACCESSORIES	
Catalog Number	Description
WH-1G	Hub w/grounding locknut 1/2" NPT
WH-2G	Hub w/grounding locknut 3/4" NPT
WH-3G	Hub w/grounding locknut 1" NPT
YOCCHP	Hole plug for 30mm operator
YOCCLOAX	Lockout for half shroud momentary buttons
YOCCLOAM	Lockout for momentary mushroom buttons
YOCCLOAP	Lockout for maintained mushroom buttons
YOCCLOAF	Lockout cover (clear) for buttons or switches

** For other entry openings, contact factory.

LEGEND PLATES***	
Blue plate with white lettering - add to end of base catalog number YOCCLPBE. Example YOCCLPBE02.	
02 = CLOSE	19 = REVERSE
03 = DOWN	20 = RUN
04 = EMERGENCY STOP	22 = START
07 = FORWARD	23 = STOP
14 = OPEN	24 = TEST
15 = POWER OFF	25 = UP
16 = POWER ON	30 = PUSH TO RESET
17 = PUSH TO TEST	56 = OFF - ON
18 = RESET	83 = HAND - OFF - AUTO

Blank plates for engraving - add to end of base catalog number YOCCLP. Example YOCCLPBE00.	
BE00 = Blue Plate	WE00 = White Plate
GN00 = Green Plate	YW00 = Yellow Plate
RD00 = Red Plate	00 = Black Plate



*** contact factory for additional selections.



Push Button - Momentary



Rotary Switch



Factory Sealed
 Contact Block
 1 N.O./1 N.C.



Mushroom - Maintained



Pilot Light - LED

FEATURES-SPECIFICATIONS

Momentary Push Button Operators*

Catalog Number	Description
D2CO1KX3	Black Push Button Full Shroud
D2CO1GX3	Green Push Button Full Shroud
D2CO1RX3	Red Push Button Full Shroud
D2CO1KH3	Black Push Button Half Shroud
D2CO1GH3	Green Push Button Half Shroud
D2CO1RH3	Red Push Button Half Shroud
D2CO1KM3	Black Push Button Mushroom
D2CO1GM3	Green Push Button Mushroom
D2CO1RM3	Red Push Button Mushroom

Maintained Mushroom Push Button Operators*

D2COM1K3	Black Push-Pull Mushroom
D2COM1G3	Green Push-Pull Mushroom
D2COM1R3	Red Push-Pull Mushroom
D2COT1R3	Red Twist to Release Mushroom

Rotary Selector Switch Operators*

D2CO52A3	Maintained 2-Position
D2CO53C3	Maintained 3-Position
D2CO63	Momentary Right, 2-Position
D2CO73	Maintained Center 3-Position
D2CO143	Maintained Left & Center 3-Position
D2CO153	Maintained Right & Center 3-Position

* Operators supplied with one universal factory sealed 1 N.O. + 1 N.C. contact block. For operator provided with two contact blocks, change last digit (3) of catalog number to 8. For actuator only, change (3) to 0.

LED Pilot Light Devices

Add to end of base catalog number D2CO3. Example D2CO3A23.

- A23 = Amber 120V AC/DC
- A4 = Amber 24V AC/DC
- AMV = Amber Multi-voltage 20V-254V AC/DC
- B23 = Blue 120V AC/DC
- B4 = Blue 24V AC/DC
- BMV = Blue Multi-voltage 20V-254V AC/DC
- C23 = Clear 120V AC/DC
- C4 = Clear 24V AC/DC
- CMV = Clear Multi-voltage 20V-254V AC/DC
- G23 = Green 120V AC/DC
- G4 = Green 24V AC/DC
- GMV = Green Multi-voltage 20V-254V AC/DC
- R23 = Red 120V AC/DC
- R25R = Red 480VAC/DC resistor
- R25T = Red 480VAC transformer
- R4 = Red 24V AC/DC
- RMV = Red multi-voltage 20V-254V AC/DC
- W23 = White frosted 120V AC/DC
- W4 = White frosted 24V AC/DC
- WMV = White frosted Multi-voltage 20V-254V AC/DC

Factory Sealed Contact Block

Catalog Number	Description	Diagram
D2CU (add suffix R for rotary selector switches)	Factory Sealed Contact Block 1 Normally Open and 1 Normally closed	

Hazardous Rating:

Class I, Division 2, Groups A,B,C,D; Class I, Zone 2, Groups IIB+H₂, IIA, T6

Terminal Capacity:

22 thru 12 AWG [0.5-2.5mm²] copper, solid or stranded conductors.
 Tightening torque 7 in-lbs. (tolerance +3.0/0.0) [~ 0.8Nm]

Contact Electrical Ratings:

NEMA A600- 7200 VA (Make), 720 VA (Break), 10 Amps Cont. @600V AC (Thermal)
 NEMA Q300- 69 VA (Make & Break), 2.5 Amps Cont. @250V DC (Thermal)



Design your own DuraTech® configuration from components by completing the following:

Box Size 1 2 Hub Size 1/2 3/4 1 Dead End Feed Thru

Clearance Hole NPS 1/2 3/4 1 Metric M20 M25 M32

Cover Size 1 2 Number of Devices 1 2 3 4

Select Devices From Top (Position 1) to Bottom

Device	Nameplate	Options
Position 1 _____	_____	_____
Position 2 _____	_____	_____
Position 3 _____	_____	_____
Position 4 _____	_____	_____

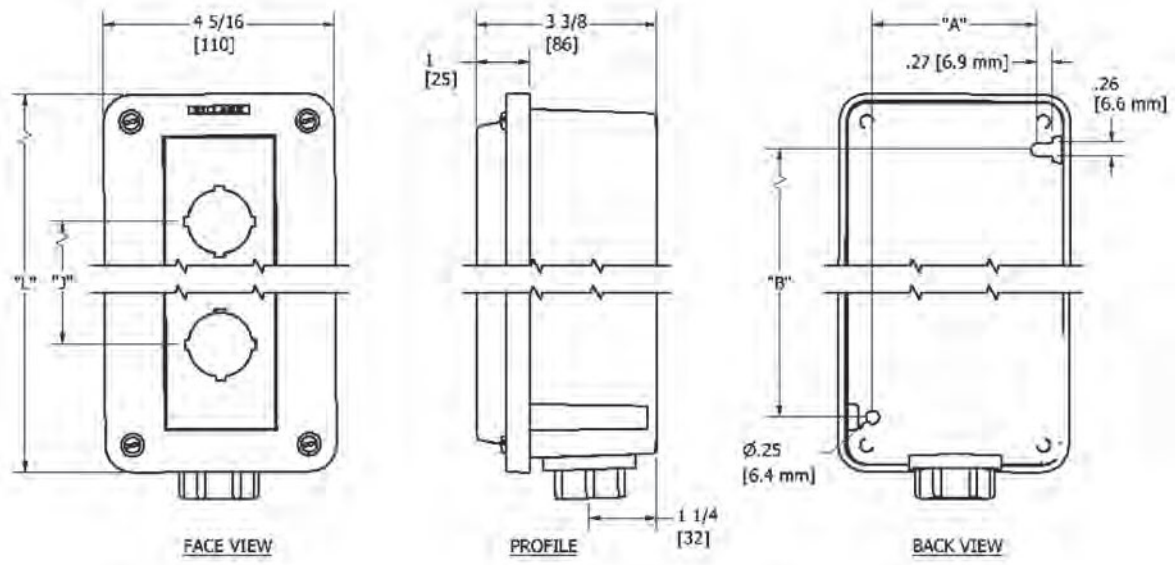

ENCL. SIZE	LENGTH "L"	DEVICE HOLES "J"	MOUNTING HOLES "A"	"B"
10	6.75 [172]	blank cover	3.06 [78]	4.70 [120]
11		one centered hole		
12		2.0 [50.8]		
20	10.36 [264]	blank cover	3.06 [78]	8.34 [212]
23		2.19 [55.5]		
24		2.06 [52.4]		

Operators bought separately are provided with gaskets to accommodate panel thickness for D2C series enclosures.

Full-Shrouded Momentary Push Button Operator

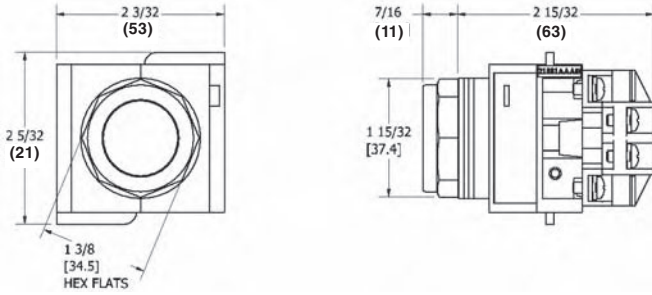

Half-Shrouded Button

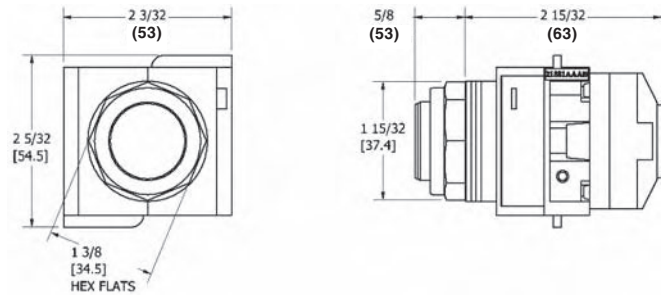

Mushroom Push Button

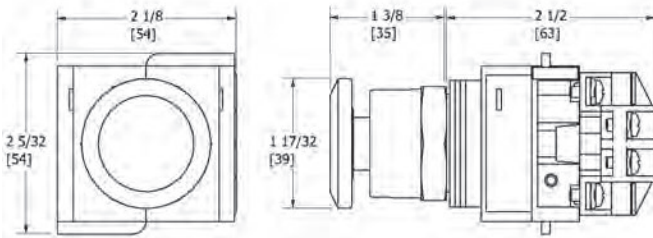

Selector Switch Device

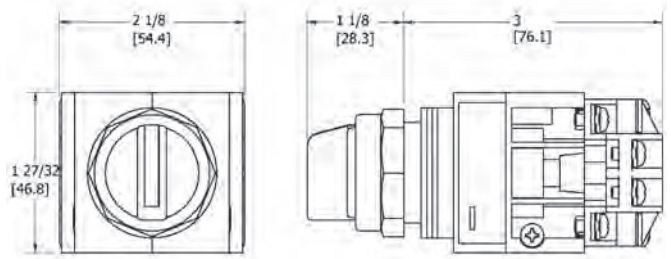

Pilot Light Multi-Voltage 20V-240V AC/DC

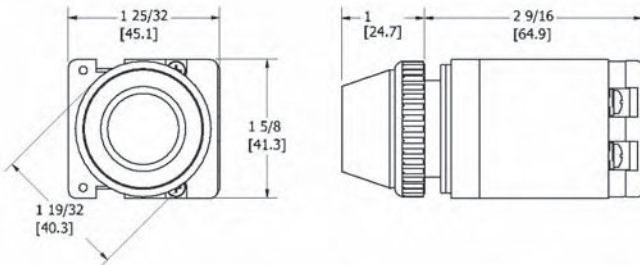

Pilot Light 120V AC (Full Voltage)

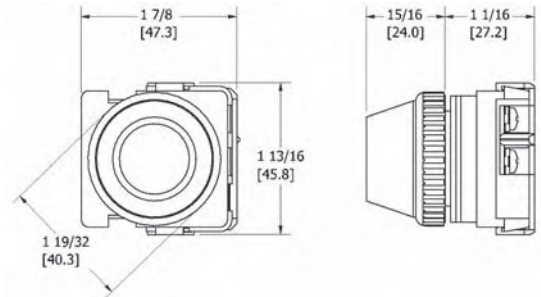

Legend Plate

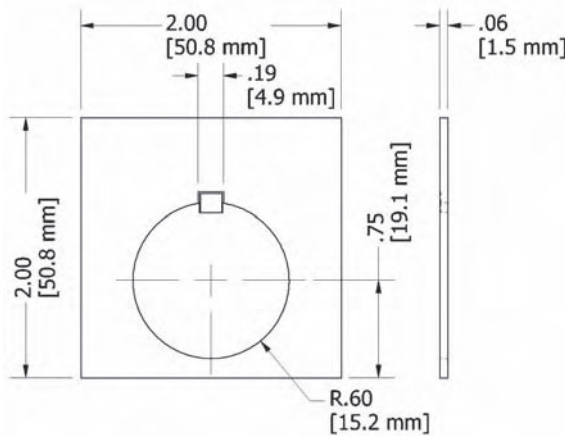



FRP Enclosure



Stainless Steel Enclosure

Class I, Div. 2, Groups A,B,C,D
Class I, Zones 1 & 2, Groups IIC, IIB, IIA
Class II, Div. 1 & 2, Groups E,F,G
Class III
NEMA 3, 4, 4x
(A)Ex de IIC T6 IP66



FEATURES-SPECIFICATIONS

Applications

Hazardous and corrosive environments such as refineries, chemical plants, water treatment and bio gas plants, and wherever a combustible gas-air mixture or combustible dust may occur.

Features

- Enclosures of Fiberglass Reinforced Polyester or Stainless Steel.
- Durable EPDM gasket on enclosure is concealed to protect it from damage or premature aging by UV light and chemical elements
- Snap-on mounting of individual explosion-protected control components to notched DIN-like rail
- Contact element utilizes a parallel bridge contact with a four point (H- contact) to ensure the utmost reliability even with very low control voltages and currents
- Fluorosilicate gasket in standard pushbutton actuators is suitable for a wide range of atmospheric conditions (-50°C to 40°C)
- LED Pilot lights (incorporating advanced voltage-sensing electronics) operate on any voltage from 20V- 254V, AC or DC
- Control switches in many configurations
- Illuminated (Push-To-Test) push buttons, ammeters, potentiometers and other control components available
- No external seals required for most applications



“THE” Standard in Hazardous Location Control

Two Types of Enclosure Materials
 • Fiberglass Reinforced Polyester (FRP)
 • 316L Stainless Steel

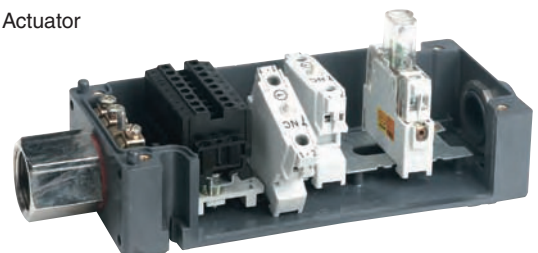
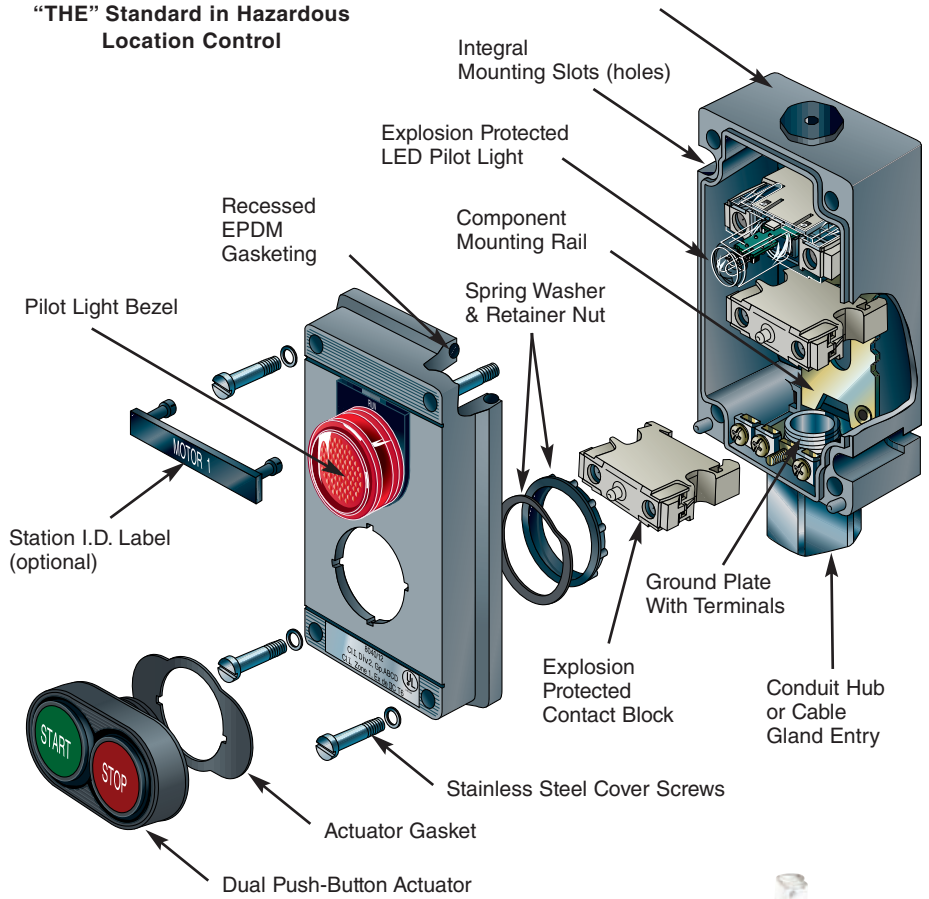

Easy Change-out Components Snap in Place



**Start
Push Button
Station**



**Start/Stop
Push Button
Station**



**E-Stop
Push Button
Station**



**Pilot Light
Station**

Class I, Div. 2, Groups A,B,C,D
 Class I, Zones 1 & 2, Groups IIC, IIB, IIA
 Class II, Div. 1 & 2, Groups E,F,GⓄ
 Class III
 NEMA 3, 4, 4X
 (A)Ex de IIC T6 IP66



FEATURES-SPECIFICATIONS

ConSpec®
 CONTROL STATIONS & PANELS

The control stations on this page are the most commonly used configurations, including combinations of pilot lights and push buttons.

Wiring Entry Logic

Insert one of the digits below to complete the control station catalog number.

BOXES WITH INTERNAL GROUND PLATE	
(for MC/TC/TEC Cable Connectors)	
1/2" NPT Top Feed	A
1/2" NPT Bottom Feed	B
1/2" NPT Feed Through	C
3/4" NPT Top Feed	D
3/4" NPT Bottom Feed	E
3/4" NPT Feed Through	F
BOXES WITH CONDUIT HUB	
1/2" NPT Top Feed	0
1/2" NPT Bottom Feed	1
1/2" NPT Feed Through	2
3/4" NPT Top Feed	3
3/4" NPT Bottom Feed	4
3/4" NPT Feed Through	5
BOXES WITH NON-METALLIC CABLE GLAND	
(Standard for IEC/CENELEC)	
M25 Compression Gland Top Feed	6
M25 Compression Gland Bottom Feed	7
M25 Compression Gland Feed Through	8
Special	9

CS MOMENTARY SINGLE PUSH BUTTON					
CATALOG NUMBER	CONTACT ARRANGEMENT		CONTACT BLOCKS	BUTTON COLOR	NAMEPLATE MARKING
	IEC	NEMA			
CSF124U011 CSS124U011			1 N.O. / 1 N.C.	Green	Start

CS MOMENTARY START-STOP PUSH BUTTONS					
CATALOG NUMBER	CONTACT ARRANGEMENT		CONTACT BLOCKS	BUTTON COLOR	NAMEPLATE MARKING
	IEC	NEMA			
CSF224U011U012 CSS224U011U012			1 N.O. / 1 N.C.	Green	Start
			1 N.O. / 1 N.C.	Red	Stop

CS MAINTAINED EMERGENCY STOP PUSH BUTTON					
CATALOG NUMBER	CONTACT ARRANGEMENT		CONTACT BLOCKS	BUTTON COLOR	NAMEPLATE MARKING
	IEC	NEMA			
CSF124C150 CSS124C150			2 N.C.	Red Large	E-Stop

CS SINGLE PILOT LIGHT					
CATALOG NUMBER	CONTACT ARRANGEMENT		VOLT	COLOR	NAMEPLATE MARKING
	IEC	NEMA			
CSF124PLRO CSS124PLRO			20V-254V AC / DC	Red LED	—

ⓄCSA Certified for Class II, Div. 1&2, EFG.
 UL Listed for Class II, Div. 2, FG.

----- Wiring entry: 4=3/4" NPT Bottom Feed. For other entries, see Wiring Entry Logic table at left.
 ----- Housing material: (F) FRP, (S) Stainless Steel.



Pilot Light & 2 Push Button Station



Pilot Light & Start/Stop Push Button Station



Selector Switch Station



Pilot Light and Selector Switch Station

Class I, Div. 2, Groups A,B,C,D
Class I, Zones 1 & 2, Groups IIC, IIB, IIA
Class II, Div. 1 & 2, Groups E,F,GⓁ
Class III
NEMA 3, 4, 4X
(A)Ex de IIC T6 IP66



FEATURES-SPECIFICATIONS

ConSpec®
CONTROL STATIONS & PANELS

The control stations on this page are the most commonly used configurations, including combinations of pilot lights, push buttons and selector switches.

Wiring Entry Logic

Insert one of the digits below to complete the control station catalog number.

BOXES WITH INTERNAL GROUND PLATE	
(for MC/TC/TEC Cable Connectors)	
1/2" NPT Top Feed	A
1/2" NPT Bottom Feed	B
1/2" NPT Feed Through	C
3/4" NPT Top Feed	D
3/4" NPT Bottom Feed	E
3/4" NPT Feed Through	F
BOXES WITH CONDUIT HUB	
1/2" NPT Top Feed	0
1/2" NPT Bottom Feed	1
1/2" NPT Feed Through	2
3/4" NPT Top Feed	3
3/4" NPT Bottom Feed	4
3/4" NPT Feed Through	5
BOXES WITH NON-METALLIC CABLE GLAND	
(Standard for IEC/CENELEC)	
M25 Compression Gland Top Feed	6
M25 Compression Gland Bottom Feed	7
M25 Compression Gland Feed Through	8
Special	9

Ⓛ CSA Certified for Class II, Div. 1&2, EFG.
UL Listed for Class II, Div. 2, FG.

CS PILOT LIGHT (RED LED)/MOMENTARY DOUBLE PUSH BUTTONS						
CATALOG NUMBER	CONTACT ARRANGEMENT		VOLT	CONTACT BLOCKS	BUTTON COLOR	NAMEPLATE MARKING
	IEC	NEMA				
CSF224PLROU231 CSS224PLROU231			20V-254V, AC/DC	1 N.O./1 N.C.	Green Red	Start Stop

CS PILOT LIGHT (RED LED)/MOMENTARY START-STOP PUSH BUTTONS						
CATALOG NUMBER	CONTACT ARRANGEMENT		VOLT	CONTACT BLOCKS	BUTTON COLOR	NAMEPLATE MARKING
	IEC	NEMA				
CSF334PLROU011U012 CSS334PLROU011U012			20V-254V, AC/DC	1 N.O. / 1 N.C. 1 N.O. / 1 N.C.	Green Red	Start Stop

CS MAINTAINED 2-POSITION SELECTOR SWITCH					
CATALOG NUMBER	CONTACT ARRANGEMENT		CONTACT BLOCKS	BUTTON COLOR	NAMEPLATE MARKING
	IEC	NEMA			
CSF124N021 CSS124N021			2-Pos./2-Pole	—	Off-On

CS MAINTAINED 3-POSITION SELECTOR SWITCH					
CATALOG NUMBER	CONTACT ARRANGEMENT		CONTACT BLOCKS	BUTTON COLOR	NAMEPLATE MARKING
	IEC	NEMA			
CSF124N273 CSS124N273			3-Pos./2-Pole	—	H-O-A

CS PILOT LIGHT/MAINTAINED 2-POSITION SELECTOR SWITCH						
CATALOG NUMBER	CONTACT ARRANGEMENT		VOLT	CONTACT BLOCKS	COLOR	NAMEPLATE MARKING
	IEC	NEMA				
CSF224PLRON021 CSS224PLRON021			20V-254V, AC/DC	2-Pos./2-Pole	Red LED	Off-On



KILLARK®

Wiring entry: 4=3/4" NPT Bottom Feed. For other entries, see Wiring Entry Logic table at left.
Housing material: (F) FRP, (S) Stainless Steel.



FRP Enclosure



Stainless Steel Enclosure

FEATURES-SPECIFICATIONS

FRP Dimensions

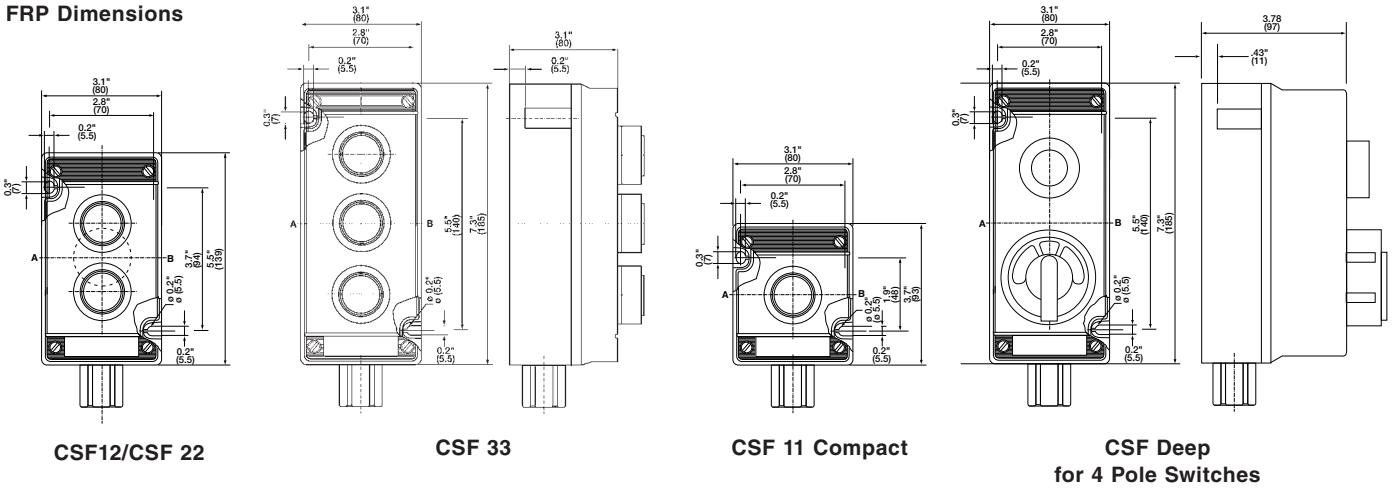

Steel Dimensions

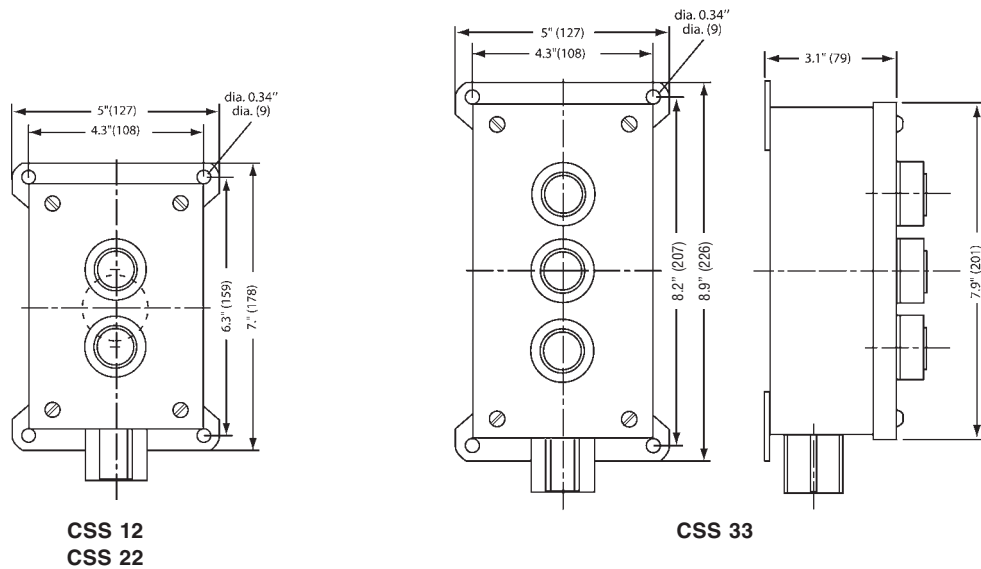



Class I, Div. 1 & 2, Groups C,D
Class I, Zones 1 & 2, Groups IIB, IIA
Class II, Div. 1 & 2, Groups E,F,G
Class III
NEMA 3, 7(C,D) 9(E,F,G)

 Listed - File E53360

 Certified - File LR11714
 See files for details or call Killark.

FEATURES-SPECIFICATIONS

SEAL-X®

Applications

SEAL-X® Series Factory Sealed push button stations, selector switches, pilot lights and tumbler switches are used to prevent the igniting of external hazardous atmospheres by the enclosed arcing devices in such areas as:

- Hazardous locations due to the presence of flammable gases or vapors, combustible dusts or easily ignitable fibers or flyings
- Installations at petroleum refineries, chemical and petrochemical plants and other processing or storage facilities where similar hazards exist
- Use in conjunction with magnetic starters or contactors for remote control of motors

Features

- Elimination of external sealing requirements
- Lower installation cost
- NEMA 3 weatherproof
- Color coded wiring-more wiring space-easier field installation
- Stainless steel captive screws for cover assembly
- Ground boss for grounding in the splice box
- Device bodies and covers are cast copper-free aluminum alloy

- Cast conduit hubs 1/2", 3/4" and 1" either dead end or feed through standard in both single and two gang assemblies
- Push button, selector switches and pilot light bodies are copper-free aluminum
- Operating shaft in both push buttons and selector switches are stainless steel
- Miniature and standard size push buttons. (Miniature 3/4" overall diameter, standard 1 3/8" overall diameter)

Factory Sealed devices eliminate the need for external sealing. The difference is the use of a sealing plate between the arcing device and the junction box. The sealing plate confines ignited gases, vapors, flames, or dust to the arcing device chamber, preventing them from traveling through the conduit system. Accurately ground flanges on both sides of the sealing plate provide flame-tight joints. Factory poured seals around the wiring pigtailed insure safe sealing. (FXCS Series)

Electrical Rating

Push button stations, selector switches 600 VAC max. heavy duty.

CONTACT BLOCK RATINGS				
CURRENT	120 VAC	240 VAC	480 VAC	600 VAC
INRUSH	60	30	15	12
BREAKING	6	3	1.5	1.2
CARRYING	10	10	10	10

DC RATINGS (MAX. AMPS)		
CURRENT	125 VDC	250 VDC
INRUSH	.55	.275
BREAKING	.55	.275
CARRYING	2.50	2.50

MODIFICATIONS	
SUFFIX NUMBER	DESCRIPTION
AL	Pilot light lens-amber
CL	Pilot light lens-clear
GL	Pilot light lens-green
RL	Pilot light lens-red
MR	Mushroom head-Push button (red)
LO	Push button LOCKOUT®
LOP	Selector switch-padlock LOCKOUT

®LOCKOUT must be installed at the factory. LED lamps available. See page C39.





FXB-2
Dead End

FXB-5
Feed Thru



FXB-8
Double Gang Dead End



FXB-11
Double Gang Feed Thru

Class I, Div. 1 & 2, Groups C,D
Class I, Zones 1 & 2, Groups IIB, IIA
Class II, Div. I & 2, Groups E,F,G
Class III
NEMA 3, 7(C,D) 9(E,F,G)

Listed - File E53360

Certified- File LR11714
 See files for details or call Killark.

FEATURES-SPECIFICATIONS

Splice Boxes

The FXB Series of splice boxes are designed for use with the FXCS and FXS Series of cover sub-assemblies.

FXB BACK BOX SELECTION AND DIMENSIONS							
CATALOG NUMBER	DESCRIPTION	HUB SIZE	EXTERNAL			MOUNTING	
			LENGTH	WIDTH	DEPTH	VERTICAL	HORIZONTAL
FXB-1	Single gang/Dead-end	1/2"	6-13/16"	3-11/16"	1-3/4"	6-3/16"	2-1/4"
FXB-2	Single gang/Dead-end	3/4"	6-13/16"	3-11/16"	1-3/4"	6-3/16"	2-1/4"
FXB-3	Single gang/Dead-end	1"	6-13/16"	3-11/16"	1-3/4"	6-3/16"	2-1/4"
FXB-4	Single gang/Feed-thru	1/2"	6-13/16"	3-11/16"	1-3/4"	6-3/16"	2-1/4"
FXB-5	Single gang/Feed-thru	3/4"	6-13/16"	3-11/16"	1-3/4"	6-3/16"	2-1/4"
FXB-6	Single gang/Feed-thru	1"	6-13/16"	3-11/16"	1-3/4"	6-3/16"	2-1/4"
FXB-7	Double gang/Dead-end	1/2"	6-13/16"	7-17/32"	2	6-3/16"	2-1/4"
FXB-8	Double gang/Dead-end	3/4"	6-13/16"	7-17/32"	2	6-3/16"	2-1/4"
FXB-9	Double gang/Dead-end	1"	7	7-17/32"	2	6-3/16"	2-1/4"
FXB-10	Double gang/Feed-thru	1/2"	6-13/16"	7-17/32"	2	6-3/16"	2-1/4"
FXB-11	Double gang/Feed-thru	3/4"	6-13/16"	7-17/32"	2	6-3/16"	2-1/4"
FXB-12	Double gang/Feed-thru	1"	7	7-17/32"	2	6-3/16"	2-1/4"



Single Push Button



Double Push Button



Pilot Light

Class I, Div. 1 & 2, Groups C,D
Class I, Zones 1 & 2, Groups IIB, IIA
Class II, Div. I & 2, Groups E,F,G
Class III
NEMA 3, 7(C,D) 9(E,F,G)

Listed - File E53360 and/or E12379

Certified - File LR11714
See files for details or call Killark.

FEATURES-SPECIFICATIONS

FXCS MOMENTARY CONTACT SINGLE PUSH BUTTON						
COVER WITH DEVICE	CATALOG NUMBER		HUB SIZE	DIAGRAM	BUTTON COLOR	NAMEPLATE MARKING [Ⓞ]
	COMPLETE UNITS (BOX & COVER)					
	DEAD-END	FEED-THRU				
FXCS-0B1	FXCS-1B1	FXCS-4B1	1/2"		Green	Start
	FXCS-2B1	FXCS-5B1	3/4"			
FXCS-0B2	FXCS-1B2	FXCS-4B2	1/2"		Red	Stop
	FXCS-2B2	FXCS-5B2	3/4"			
FXCS-0B3	FXCS-1B3	FXCS-4B3	1/2"		Black	Specify
	FXCS-2B3	FXCS-5B3	3/4"			

FXCS MOMENTARY CONTACT DOUBLE PUSH BUTTON						
COVER WITH DEVICE	CATALOG NUMBER		HUB SIZE	DIAGRAM	BUTTON COLOR	NAMEPLATE MARKING [Ⓞ]
	COMPLETE UNITS (BOX & COVER)					
	DEAD-END	FEED-THRU				
FXCS-0B4	FXCS-1B4	FXCS-4B4	1/2"		Green/Red	Start/Stop
	FXCS-2B4	FXCS-5B4	3/4"			
FXCS-0B4-U	FXCS-1B4U	FXCS-4B4-U	1/2"		Green/Red	Start/Stop
	FXCS-2B4U	FXCS-5B4-U	3/4"			
FXCS-0B5	FXCS-1B5	FXCS-4B5	1/2"		Green/Green	Start/Stop
	FXCS-2B5	FXCS-5B5	3/4"			
FXCS-0B7	FXCS-1B7	FXCS-4B7	1/2"		Black/Black	Specify
	FXCS-2B7	FXCS-5B7	3/4"			

FXCS PILOT LIGHT							
COVER WITH DEVICE	CATALOG NUMBER		HUB SIZE	DIAGRAM	VOLT	LENS COLOR [Ⓞ]	NAMEPLATE MARKING [Ⓞ]
	COMPLETE UNITS (BOX & COVER)						
	DEAD-END	FEED-THRU					
FXCS-0B24CL	FXCS-1B24CL	FXCS-4B24CL	1/2"		120V	Clear	Specify
	FXCS-2B24CL	FXCS-5B24CL	3/4"				
FXCS-0B24GL	FXCS-1B24GL	FXCS-4B24GL	1/2"		120V	Green	Specify
	FXCS-2B24GL	FXCS-5B24GL	3/4"				
FXCS-0B24RL	FXCS-1B24RL	FXCS-4B24RL	1/2"		120V	Red	Specify
	FXCS-2B24RL	FXCS-5B24RL	3/4"				

[Ⓞ]For other than standard marking, refer to the special feature section of price list.

[Ⓞ]Lens colors other than listed may be specified by changing lens color suffix. See modifications page C12.

NOTE: Boxes and covers shipped separately.

*For control stations with 1" conduit openings or for double gang assemblies, order cover with device and box as separate components.



KILLARK



Double Pilot Lights



Pilot Light Push Button



Pilot Light Two Mini Push Buttons



Maintained Push Button

Class I, Div. 1 & 2, Groups C,D
 Class I, Zones 1 & 2, Groups IIB, IIA
 Class II, Div. I & 2, Groups E,F,G Class III
 NEMA 3, 7(C,D) 9(E,F,G)

Listed - File E53360 and /or E12379

Certified - File LR11714

See files for details or call Killark.

FEATURES-SPECIFICATIONS

FXCS DOUBLE PILOT LIGHTS							
COVER WITH DEVICE	CATALOG NUMBER		HUB SIZE	DIAGRAM	LAMP VOLTS	LENS COLOR ^②	NAMEPLATE MARKING ^①
	COMPLETE UNITS (BOX & COVER)						
	DEAD-END	FEED-THRU					
FXCS-0B30CL	FXCS-1B30CL	FXCS-4B30CL	1/2"		120V	Clear	Specify
	FXCS-2B30CL	FXCS-5B30CL	3/4"				
FXCS-0B30GL	FXCS-1B30GL	FXCS-4B30GL	1/2"		120V	Green	Specify
	FXCS-2B30GL	FXCS-5B30GL	3/4"				
FXCS-0B30RL	FXCS-1B30RL	FXCS-4B30RL	1/2"		120V	Red	Specify
	FXCS-2B30RL	FXCS-5B30RL	3/4"				
FXCS-0B30RL-GL	FXCS-1B30RL-GL	FXCS-4B30RL-GL	1/2"		120V	Red/Green	Specify
	FXCS-2B30RL-GL	FXCS-5B30RL-GL	3/4"				

FXCS MOMENTARY CONTACT PUSH BUTTON AND PILOT LIGHT									
COVER WITH DEVICE	CATALOG NUMBER		HUB SIZE	DIAGRAM	LAMP VOLTS	BUTTON COLOR	LENS COLOR ^②	NAMEPLATE MARKING ^①	
	COMPLETE UNITS (BOX & COVER)							BUTTON	LENS
	DEAD-END	FEED-THRU							
FXCS-0B13-C	FXCS-1B13-C	FXCS-4B13-C	1/2"		120V	Red	Clear	Stop	Specify
	FXCS-2B13-C	FXCS-5B13-C	3/4"						
FXCS-0B13-O	FXCS-1B13-O	FXCS-4B13-O	1/2"		120V	Green	Green	Start	Specify
	FXCS-2B13-O	FXCS-5B13-O	3/4"						
FXCS-0B13-U	FXCS-1B13-U	FXCS-4B13-U	1/2"		120V	Black	Red	Specify	Specify
	FXCS-2B13-U	FXCS-5B13-U	3/4"						

FXCS MOMENTARY CONTACT 2 MINI PUSH BUTTON AND 1 PILOT LIGHT								
COVER WITH DEVICE	CATALOG NUMBER		HUB SIZE	DIAGRAM	BUTTON COLOR	LENS COLOR ^②	NAMEPLATE MARKING ^①	
	COMPLETE UNITS (BOX & COVER)						BUTTON	LENS
	DEAD-END	FEED-THRU						
FXCS-0A15	FXCS-1A15	FXCS-4A15	1/2"		Red/Green	Red	Stop	Start
	FXCS-2A15	FXCS-5A15	3/4"					

FXCS MAINTAINED CONTACT - PUSH/PULL MUSHROOM ^④				
BUTTON COLOR	CONTACT TYPE	COVER ASSEMBLY CAT. #	CATALOG # WITH LOCKOUT #	NAMEPLATE MARKING
GREEN	1NO/1NC	FXCS-OMMG3	FXCS-OMMR3-LOM	③
RED	1NO/1NC	FXCS-OMMR3		
BLACK	1NO/1NC	FXCS-OMMK3		

① For other than standard marking, refer to the special feature section of price list.

② Lens colors other than listed may be specified by changing lens color suffix. See modifications page C12.

③ Three nameplates supplied (Start/Stop, Blank, Emergency Stop) with FXCS maintained push button.

④ Operation-when push button is depressed and contacts activated, operator will remain in depressed position until pulled out to normal position.

NOTE: Boxes and covers shipped separately.

*For control stations with 1" conduit opening or for double gang assemblies, order cover with device and box as separate components.





Selector Switch



Key Selector Switch

Class I, Div. 1 & 2, Groups C,D
Class I, Zones 1 & 2, Groups IIB, IIA
Class II, Div. 1 & 2, Groups E,F,G Class III
NEMA 3, 7(C,D) 9(E,F,G)

Listed - File E53360 and/or E12379

Certified - File LR11714

See files for details or call Killark.

FEATURES-SPECIFICATIONS

FXCS TWO POSITION SELECTOR SWITCH - MAINTAINED CONTACT ①										
CATALOG NUMBER						LEFT POSITION		RIGHT POSITION		
STANDARD COVER WITH DEVICE	HUB SIZE	STANDARD COMPLETE UNITS (BOX & COVER)		KEYED COVER WITH DEVICE	KEYED COMPLETE UNITS ② (BOX & COVER)		LEFT CONTACT	RIGHT CONTACT	LEFT CONTACT	RIGHT CONTACT
		DEAD-END	FEED-THRU		DEAD-END	FEED-THRU				
FXCS-0S2A1	1/2"	FXCS-1S2A1	FXCS-4S2A1	FXCS-0K2A1	FXCS-1K2A1	FXCS-4K2A1				
FXCS-0S2A1	3/4"	FXCS-2S2A1	FXCS-5S2A1		FXCS-2K2A1	FXCS-5K2A1				
FXCS-0S2A5	1/2"	FXCS-1S2A5	FXCS-4S2A5	FXCS-0K2A5	FXCS-1K2A5	FXCS-4K2A5				
FXCS-0S2A5	3/4"	FXCS-2S2A5	FXCS-5S2A5		FXCS-2K2A5	FXCS-5K2A5				

FXCS THREE POSITION SELECTOR SWITCH - MAINTAINED CONTACT ①												
CATALOG NUMBER						LEFT POSITION		CENTER POSITION		RIGHT POSITION		
STANDARD COVER WITH DEVICE	HUB SIZE	STANDARD COMPLETE UNITS (BOX & COVER)		KEYED COVER WITH DEVICE	KEYED COMPLETE UNITS ② (BOX & COVER)		LEFT CONTACT	RIGHT CONTACT	LEFT CONTACT	RIGHT CONTACT	LEFT CONTACT	RIGHT CONTACT
		DEAD-END	FEED-THRU		DEAD-END	FEED-THRU						
FXCS-0S3C4	1/2"	FXCS-1S3C4	FXCS-4S3C4	FXCS-0K3C4	FXCS-1K3C4	FXCS-4K3C4						
FXCS-0S3C4	3/4"	FXCS-2S3C4	FXCS-5S3C4		FXCS-2K3C4	FXCS-5K3C4						
FXCS-0S3C5	1/2"	FXCS-1S3C5	FXCS-4S3C5	FXCS-0K3C5	FXCS-1K3C5	FXCS-4K3C5						
FXCS-0S3C5	3/4"	FXCS-2S3C5	FXCS-5S3C5		FXCS-2K3C5	FXCS-5K3C5						

FXCS TWO POSITION SELECTOR SWITCH - SPRING RETURNED ①										
CATALOG NUMBER						LEFT POSITION		RIGHT POSITION		
STANDARD COVER WITH DEVICE	HUB SIZE	STANDARD COMPLETE UNITS (BOX & COVER)		KEYED COVER WITH DEVICE	KEYED COMPLETE UNITS ② (BOX & COVER)		LEFT CONTACT	RIGHT CONTACT	LEFT CONTACT	RIGHT CONTACT
		DEAD-END	FEED-THRU		DEAD-END	FEED-THRU				
FXCS-0S2L3F	1/2"	FXCS-1S2L3F	FXCS-4S2L3F	FXCS-0K2L3F22D	FXCS-1K2L3F22D	FXCS-4K2L3F22D				
FXCS-0S2L3F	3/4"	FXCS-2S2L3F	FXCS-5S2L3F		FXCS-2K2L3F22D	FXCS-5K2L3F22D				

TYPE OPERATION — Spring return to left from right — Maintained in left — 1 N.O. Contact — 1 N.C. Contact

FXCS THREE POSITION SELECTOR SWITCH - SPRING RETURNED ①												
CATALOG NUMBER						LEFT POSITION		CENTER POSITION		RIGHT POSITION		
STANDARD COVER WITH DEVICE	HUB SIZE	STANDARD COMPLETE UNITS (BOX & COVER)		KEYED COVER WITH DEVICE	KEYED COMPLETE UNITS ② (BOX & COVER)		LEFT CONTACT	RIGHT CONTACT	LEFT CONTACT	RIGHT CONTACT	LEFT CONTACT	RIGHT CONTACT
		DEAD-END	FEED-THRU		DEAD-END	FEED-THRU						
FXCS-0S3M6G	1/2"	FXCS-1S3M6G	FXCS-4S3M6G	FXCS-0K3M6G32D	FXCS-1K3M6G32D	FXCS-4K3M6G32D						
FXCS-0S3M6G	3/4"	FXCS-2S3M6G	FXCS-5S3M6G		FXCS-2K3M6G32D	FXCS-5K3M6G32D						
FXCS-0S3L6G	1/2"	FXCS-1S3L6G	FXCS-4S3L6G	FXCS-0K3L6G32D	FXCS-1K3L6G32D	FXCS-4K3L6G32D						
FXCS-0S3L6G	3/4"	FXCS-2S3L6G	FXCS-5S3L6G		FXCS-2K3L6G32D	FXCS-5K3L6G32D						
FXCS-0S3R6G	1/2"	FXCS-1S3R6G	FXCS-4S3R6G	FXCS-0K3R6G32D	FXCS-1K3R6G32D	FXCS-4K3R6G32D						
FXCS-0S3R6G	3/4"	FXCS-2S3R6G	FXCS-5S3R6G		FXCS-2K3R6G32D	FXCS-5K3R6G32D						

TYPE OPERATION — Spring return to center from left — Maintained center and right 2 N.O. Contacts

① Nameplates are double sided.

For other than standard marking, refer to the special feature section of the price list.

STANDARD NAMEPLATE MARKINGS — 2 POSITION — Blank or Off-On — 3 POSITION — Blank or Hand-Off-Auto.

② Key operated selector switches are randomly keyed with keys removable in all positions.

For keyed alike or key removable in other than all positions contact factory.

For control stations with 1" conduit opening or for double gang assemblies, order cover with device and box as separate components.



FXS SERIES • CONTROLS
FACTORY SEALED TUMBLER SWITCHES AND
GROUND FAULT INTERRUPTER



Tumbler Switches

Ground Fault Interrupter



For GFI Protection with receptacle, See page PR26
Class I, Div. 1 & 2, Groups C,D
Class I, Zones 1 & 2, Groups IIB,IIA
Class II, Div. 1 & 2, Groups E,F,G
Class III
NEMA 3, 7(C,D) 9(E,F,G)

FEATURES-SPECIFICATIONS

Applications

FXS Tumbler Switches are suitable for applications where making, breaking or changing connections in an electrical circuit is required and where conditions of load do not exceed the switch ratings.

Listed - File E53360 and/or Ffile E10501

Certified - File LR11714
 See files for details or call Killark.

Applications

FXS Ground Fault Interrupters are designed to interrupt a circuit when a ground fault is detected on equipment which may be handled by personnel in hazardous locations.

Features

- Test and Reset push buttons are provided on cover assembly. Unit should be tested monthly
- Includes new GFI to meet latest UL943 GFCI standards revisions
- Exterior gasket provides NEMA 3 weatherproof protection
- Ground boss for grounding in the splice box
- Color coded wiring
- Captive cover bolts are made from stainless steel

Electrical Rating

GFI units are rated at 20A, 120 VAC, 60HZ. Class A.
 4-6 milliamp trip setting
 Trip Time-UL Curve

Listed - File E80595

Certified - File LR61895
 See files for details or call Killark.

FXS TUMBLER SWITCHES					
CATALOG NUMBER			HUB SIZE	SWITCH STYLE	SWITCH RATING 120/277 VAC, 1Ø
COMPLETE UNIT					
COVER WITH SWITCH	(BOX, COVER AND SWITCH)				
	DEAD-END	FEED-THRU			
FXS-1C	FXS-11C	FXS-41C	1/2"	1-POLE	20 A [Ⓢ]
	FXS-21C	FXS-51C	3/4"		
FXS-2C	FXS-12C	FXS-42C	1/2"	2-POLE	20 A [Ⓢ]
	FXS-22C	FXS-52C	3/4"		
FXS-8C	FXS-18C	FXS-48C	1/2"	3-POLE	Ø
	FXS-28C	FXS-58C	3/4"		
FXS-3C	FXS-13C	FXS-43C	1/2"	3-WAY/ SPDT (No off)	20 A [Ⓢ]
	FXS-23C	FXS-53C	3/4"		
FXS-5C	FXS-15C	FXS-45C	1/2"	SPDT (Center off)	20 A [Ⓢ]
	FXS-25C	FXS-55C	3/4"		
FXS-6C	FXS-16C	FXS-46C	1/2"	DPDT (No off)	20 A [Ⓢ]
	FXS-26C	FXS-56C	3/4"		
FXS-1D	FXS-11D	FXS-41D	1/2"	1-POLE	30 A [Ⓢ]
	FXS-21D	FXS-51D	3/4"		
FXS-2D	FXS-12D	FXS-42D	1/2"	2-POLE	30 A [Ⓢ]
	FXS-22D	FXS-52D	3/4"		
FXS-4C	—	—	—	4-WAY	20 A [Ⓢ]

[Ⓢ]Rated 15 amperes, 240/480 VAC., 3Ø; 3HP-240 VAC., 5 HP-480 VAC.

[Ⓢ]Horsepower rated 1 HP at 120 VAC, 2 HP at 240 VAC.

FXS GROUND FAULT INTERRUPTER†				
CATALOG NUMBER			HUB SIZE	
COMPLETE UNIT	COVER ASSEMBLY	BACK BOX*	DEAD END	FEED THRU
FXS-GFI-1020	FXS-GFI03	FXB-1		
FXS-GFI-2020	FXS-GFI03	FXB-2	3/4"	3/4"
FXS-GFI-3020	FXS-GFI03	FXB-3	1"	1"
FXS-GFI-1120	FXS-GFI03	FXB-4	1/2"	1/2"
FXS-GFI-2120	FXS-GFI03	FXB-5	3/4"	3/4"
FXS-GFI-3120	FXS-GFI03	FXB-6	1"	1"

For control stations with 1" conduit opening or for double gang assemblies, order cover with device and box as separate components.

*Boxes and covers shipped separately.

†See page DE25 for additional ground fault control stations.

FXS GROUND FAULT INTERRUPTER WITH LED LAMP	
CATALOG NUMBER FOR COVER ASSEMBLY	FXS-GFI03PL

* Order FXB back box as separate item.



KILLARK®



Class I, Div. 1 & 2, Groups C,D
Class I, Zones 1 & 2, Groups IIB, IIA
Class II, Div. 1 & 2, Groups E,F,G
Class III
NEMA 7(C,D) 9(E,F,G)

Listed - File E53360

Certified - File LR11714, LR11712
 See files for details or call Killark.

FEATURES-SPECIFICATIONS

Applications

- Hazardous locations due to the presence of flammable gases or vapors, combustible dusts or easily ignitable fiber or flyings
- Installations at petroleum refineries, chemical and petrochemical plants and other processing or storage facilities where similar hazards exist
- Use in conjunction with magnetic starters or contactors for remote control of motors

Features

- Device bodies and covers are cast copper-free Aluminum alloy and provide a wide assortment for custom assemblies
- Cast conduit hubs 1/2", 3/4" and 1" either dead end or feed thru standard in both single and two gang, SWB-1 thru SWB-12 device bodies
- SWB-13 thru SWB-38 are designed for custom drilled and tapped conduit openings on all four sides and the back
- Ground flange joint between bolted cover and box provide required flame path
- Push button, selector switches and pilot light operator bodies are copper-free aluminum
- Operating shaft in both push buttons and selector switches are stainless steel
- Open space between gangs for easy wiring from one cover to another

- Miniature and standard size push buttons. (Miniature 3/4" overall diameter, standard 1-3/8" overall diameter.)
- Contact blocks are rated heavy duty, 600 VAC max
- Internal ground screw

Electrical Rating

Push button stations, selector switches heavy duty 600 VAC max.

Pilot lights 120 VAC.

XCS Special Assemblies

To order XCS cover assemblies for use with multi-gang or 1" hub type SWB Series splice boxes, simply order as follows:

Example: **XCS-0B1** — Cover Assembly
SWB-6 — Splice box with 1" feed thru hubs

Example: **XCS-0B1** — Cover Assembly
XCS-0B24RL — Cover Assembly
SWB-12 — Double gang splice box

NOTE: Splice boxes and cover assemblies are packaged in separate cartons.

MODIFICATIONS	
CATALOG SUFFIX	DESCRIPTION
AL	Pilot light lens-amber
CL	Pilot light lens-clear
GL	Pilot light lens-green
RL	Pilot light lens-red
T2	ⓉPilot light transformer — 220/110VAC
T4	ⓉPilot light transformer — 440/110VAC
MR	Mushroom head push button (red)
LO	Push button lockout [Ⓢ]
LOP	Selector switch padlock-lockout
SU1	Stainless steel cover screws

Ⓣ One transformer required for each pilot light. Deep device bodies required for all except single pilot light units when transformers are used.

Ⓢ Push button lockout must be factory installed. LED lamps available. See page C39.

CONTACT BLOCK RATINGS				
CURRENT	120 VAC	240 VAC	480 VAC	600 VAC
INRUSH	60	30	15	12
BREAKING	6	3	1.5	1.2
CARRYING	10	10	10	10

DC RATINGS (MAX. AMPS)		
CURRENT	125 VAC	250 VAC
INRUSH	.55	.275
BREAKING	.55	.275
CARRYING	2.50	2.50





Class I, Div. 1 & 2, Groups C,D
Class I, Zones 1 & 2, Groups IIB, IIA
Class II, Div. 1 & 2, Groups E,F,G
Class III
NEMA 7(C,D) 9(E,F,G)

Listed - File E53360

Certified - LR11712

See files for details or call Killark.

FEATURES-SPECIFICATIONS



SWB DEVICE BODIES AND DIMENSIONS						
CATALOG NUMBER	HUB SIZE	EXTERNAL			MOUNTING	
		LENGTH	WIDTH	DEPTH	VERTICAL	HORIZONTAL
SWB-1	1/2"	5-7/8"(149)	3"(76)	2-1/4"(57)	5-3/8"(137)	2-3/8"(60)
SWB-2	3/4"	5-7/8"(149)	3"(76)	2-1/4"(57)	5-3/8"(137)	2-3/8"(60)
SWB-3	1"	5-7/8"(149)	3"(76)	2-1/4"(57)	5-3/8"(137)	2-3/8"(60)
SWB-4	1/2"	5-7/8"(149)	3"(76)	2-1/4"(57)	5-3/8"(137)	2-3/8"(60)
SWB-5	3/4"	5-7/8"(149)	3"(76)	2-1/4"(57)	5-3/8"(137)	2-3/8"(60)
SWB-6	1"	5-7/8"(149)	3"(76)	2-1/4"(57)	5-3/8"(137)	2-3/8"(60)
SWB-7	1/2"	5-7/8"(149)	6-1/2"(165)	2-1/4"(57)	5-3/8"(137)	2-1/2"(64)
SWB-8	3/4"	5-7/8"(149)	6-1/2"(165)	2-1/4"(57)	5-3/8"(137)	2-1/2"(64)
SWB-9	1"	5-7/8"(149)	6-1/2"(165)	2-1/4"(57)	5-3/8"(137)	2-1/2"(64)
SWB-10	1/2"	5-7/8"(149)	6-1/2"(165)	2-1/4"(57)	5-3/8"(137)	2-1/2"(64)
SWB-11	3/4"	5-7/8"(149)	6-1/2"(165)	2-1/4"(57)	5-3/8"(137)	2-1/2"(64)
SWB-12	1"	5-7/8"(149)	6-1/2"(165)	2-1/4"(57)	5-3/8"(137)	2-1/2"(64)
SWB-13	①	5-1/4"(133)	3-5/8"(92)	2-1/2"(64)	6-1/8"(156)	2-3/8"(60)
SWB-14	②	5-1/4"(133)	3-5/8"(92)	3-5/16"(84)	6-1/8"(156)	2-3/8"(60)
SWB-17	①	10-3/8"(264)	3-5/8"(92)	2-1/2"(64)	11-3/8"(289)	2-1/8"(54)
SWB-18	②	5-1/4"(133)	7-1/8"(181)	3-5/16"(84)	6"(152)	5-3/4"(146)
SWB-19	②	5-1/4"(133)	10-5/8"(270)	3-5/16"(84)	6"(152)	9-3/16"(233)
SWB-20	②	5-1/4"(133)	14-1/8"(359)	3-5/16"(84)	6"(152)	12-11/16"(322)
SWB-21	②	5-1/4"(133)	17-5/8"(448)	3-5/16"(84)	6"(152)	16-3/16"(411)
SWB-32	②	12"(305)	10-5/8"(270)	3-5/16"(84)	11-1/8"(283)	9-3/16"(233)
SWB-33	②	10-3/8"(264)	14-1/8"(359)	3-5/16"(84)	11-3/16"(284)	12-3/4"(324)
SWB-34	②	12"(305)	17-3/4"(451)	3-5/16"(84)	11-5/16"(287)	16-1/4"(413)
SWB-38	②	17-1/8"(435)	17-3/4"(451)	3-5/16"(84)	11-5/16"(287)	16-1/4"(413)
SWB-42	3/4"	5-1/4"(133)	3-5/8"(92)	3-5/16"(84)	6-1/8"(156)	2-3/8"(60)
SWB-45	3/4"	5-1/4"(133)	3-5/8"(92)	3-5/16"(84)	6-1/8"(156)	2-3/8"(60)
SWB-49	3/4"	5-1/4"(133)	3-5/8"(92)	3-5/16"(84)	6-1/8"(156)	2-3/8"(60)

① Maximum size drilled and tapped opening 1" — Shallow device bodies.

② Maximum size drilled and tapped opening 1-1/2" — Deep device bodies.

③ SWB-1 thru SWB-12 Boxes have cast in conduit hubs. Additional conduit openings can not be included. Use SWB-13-14 or 18 for custom conduit requirements. See following page for custom conduit information. SWB-13 through SWB-38 boxes are blank without conduit openings and can be factory or field installed. See following page for custom conduit information.



Conduit Opening Location Charts

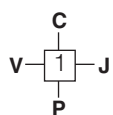

SWB-13-14

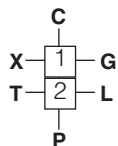

SWB-17

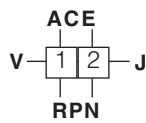

SWB-18

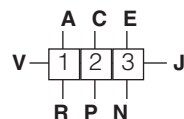

SWB-19

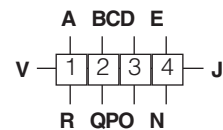

SWB-20

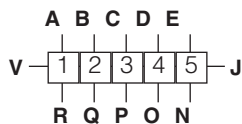

SWB-21



SWB-32

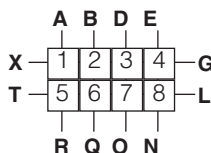

SWB-33

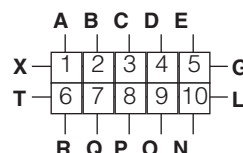

SWB-34

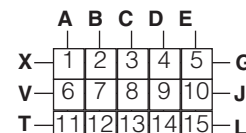

SWB-38

FEATURES-SPECIFICATIONS

To specify conduit openings select the letter on these sketches which indicates the position desired. All conduit openings will be evenly spaced and located in the area indicated on the location chart. When they are to be more accurately located, submit a sketch with spacing dimensions. Specific conduit openings must be located dimensionally from box centerlines to conduit centerlines and from outside back surface of box to conduit centerline.

Ordering Instructions:

- (1) Select the letter on location chart which indicates conduit opening position desired.
- (2) Select symbol number from chart which indicates conduit opening type and size.
- (3) Combine the conduit location letter, size and type number, and add as a suffix to SWB box catalog number.

Example: SWB-18-C1-J1-P1-V1

MINIMUM HUB CENTERS FOR DRILLED AND TAPPED AND UNION HUBS						
SIZE	FORM	1/2"	3/4"	1"	1-1/4"	1-1/2"
1/2"	⊕MIN	1-3/16"(46)	—	—	—	—
1/2"	⊕PRE	1-3/8"(35)	—	—	—	—
1/2"	⊕GU	1-5/8"(41)	—	—	—	—
3/4"	⊕MIN	1-3/8"(35)	1-1/2"(38)	—	—	—
3/4"	⊕PRE	1-1/2"(38)	1-5/8"(41)	—	—	—
3/4"	⊕GU	1-3/4"(44)	1-13/16"(46)	—	—	—
1"	⊕MIN	1-1/2"(38)	1-3/4"(44)	1-13/16"(46)	—	—
1"	⊕PRE	1-3/4"(44)	1-7/8"(48)	2"(51)	—	—
1"	⊕GU	1-7/8"(48)	2"(51)	2-1/8"(54)	—	—
1-1/4"	⊕MIN	1-11/16"(43)	1-15/16"(49)	2-1/16"(52)	2-5/16"(59)	—
1-1/4"	⊕PRE	1-15/16"(49)	2-1/16"(52)	2-1/4"(57)	2-1/2"(64)	—
1-1/4"	⊕GU	2-1/16"(52)	2-1/4"(57)	2-5/16"(59)	2-1/2"(64)	—
1-1/2"	⊕MIN	1-15/16"(49)	2-1/16"(52)	2-3/16"(56)	2-1/2"(64)	2-5/8"(67)
1-1/2"	⊕PRE	2-1/8"(54)	2-1/4"(57)	2-3/8"(60)	2-5/8"(67)	2-3/4"(70)
1-1/2"	⊕GU	2-3/16"(56)	2-9/32"(58)	7/16"(11)	2-5/8"(67)	2-3/4"(70)
Locknut Bushing Conduit		1-1/8"(29)	1-3/8"(35)	1-11/16"(43)	2-3/16"(56)	2-7/16"(62)
Locknut Bushing Conduit		1"(25)	1-1/4"(32)	1-1/2"(38)	1-7/8"(48)	2-1/8"(54)
Locknut Bushing Conduit		7/8"(22)	1-1/16"(27)	1-3/8"(35)	1-11/16"(43)	1-15/16"(49)

- ⊕ Minimum spacing required to provide clearance over locknuts and bushings.
- ⊕ Preferred—more liberal spacings between centers of conduits to be used whenever possible.
- ⊕ GU—spacing required for GU Series unions.
- ⊕ Union hubs are supplied by using a drilled and tapped opening with GUM Series Union.
- † Consult factory for special or additional conduit sizes, locations, and combinations required but not illustrated.

SYMBOL NUMBERS		
CONDUIT SIZE	CONDUIT OPENINGS	
	DRILLED AND TAPPED	UNION [⊕]
1/2"	1	11
3/4"	2	12
1"	3	13
1-1/4"	4	14
1-1/2"	5	15

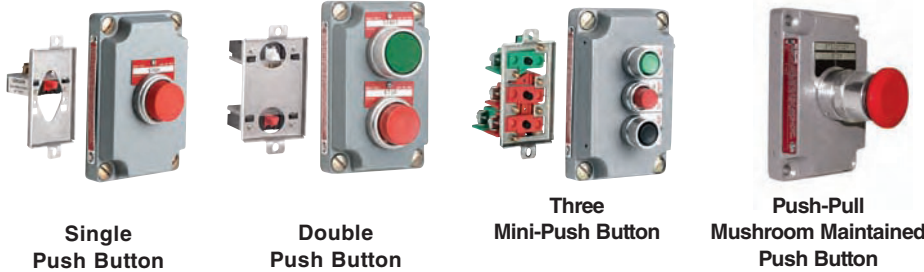

**Class I, Div. 1 & 2, Groups C,D
Class I, Zones 1 & 2, Groups IIB, IIA
Class II, Div. 1 & 2, Groups E,F,G
Class III
NEMA 7(C,D) 9(E,F,G)**

Listed - File E53360

Certified - File LR11714
See files for details or call Killark.

FEATURES-SPECIFICATIONS

XCS MOMENTARY CONTACT SINGLE PUSH BUTTON						
COVER WITH DEVICE	CATALOG NUMBER		HUB SIZE	DIAGRAM	BUTTON COLOR ^②	NAMEPLATE MARKING ^③
	COMPLETE UNITS (BOX & COVER)					
	DEAD-END	FEED-THRU				
XCS-0B1	XCS-1B1	XCS-4B1	1/2"		Green	Start
	XCS-2B1	XCS-5B1	3/4"			
XCS-0B2	XCS-1B2	XCS-4B2	1/2"		Red	Stop
	XCS-2B2	XCS-5B2	3/4"			
XCS-0B3	XCS-1B3	XCS-4B3	1/2"		Black	Specify
	XCS-2B3	XCS-5B3	3/4"			

XCS MOMENTARY CONTACT DOUBLE PUSH BUTTON						
COVER WITH DEVICE	CATALOG NUMBER		HUB SIZE	DIAGRAM	BUTTON COLOR ^②	NAMEPLATE MARKING ^③
	COMPLETE UNITS (BOX & COVER)					
	DEAD-END	FEED-THRU				
XCS-0B4	XCS-1B4	XCS-4B4	1/2"		Green-Red	Start/Stop
	XCS-2B4	XCS-5B4	3/4"			
XCS-0B4-U	XCS-1B4-U	XCS-4B4-U	1/2"		Green-Red	Start/Stop
	XCS-2B4-U	XCS-5B4-U	3/4"			
XCS-0B5	XCS-1B5	XCS-4B5	1/2"		Green-Green	Start/Start
	XCS-2B5	XCS-5B5	3/4"			
XCS-0B7	XCS-1B7	XCS-4B7	1/2"		Black-Black	Specify
	XCS-2B7	XCS-5B7	3/4"			

XCS MOMENTARY CONTACT THREE MINI PUSH BUTTONS						
COVER WITH DEVICE	CATALOG NUMBER		HUB SIZE	DIAGRAM	BUTTON COLOR ^②	NAMEPLATE MARKING ^③
	COMPLETE UNITS (BOX & COVER)					
	DEAD-END	FEED-THRU				
XCS-0A8	XCS-1A8	XCS-4A8	1/2"		Green-Red	Start/Stop
	XCS-2A8	XCS-5A8	3/4"		Black	Specify
XCS-0A9	XCS-1A9	XCS-4A9	1/2"		Black	Specify
	XCS-2A9	XCS-5A9	3/4"			

① For other than standard marking, refer to the special feature section of price list.

② Lens colors other than listed may be specified by changing lens color suffix. See modifications page C18.

For control stations with 1" conduit openings or for multi-gang assemblies, order cover with devices and box as separate components.

XCS MAINTAINED CONTACT PUSH PULL MUSHROOM PUSH BUTTON^④			
CATALOG NUMBER (COVER WITH DEVICE)	DIAGRAM	BUTTON COLOR	NAMEPLATE MARKING
XCS-OMMG3		GREEN	③
XCS-OMMR3		RED	
XCS-OMMK3		BLACK	

③ Three nameplates supplied (Start/Stop, Blank, Emergency Stop) with XCS maintained push button.

④ Operation - when push button is depressed and contact activated, operator will remain in depressed position until pulled out in normal position.



Pilot Light



Double Pilot Light



Pilot Light Push Button



Pilot Light Two Mini Push Buttons

Class I, Div. 1 & 2, Groups C,D
Class I, Zones 1 & 2, Groups IIB, IIA
Class II, Div. 1 & 2, Groups E,F,G
Class III
NEMA 7(C,D) 9(E,F,G)

Listed - File E53360

Certified - File LR11714

See files for details or call Killark.

FEATURES-SPECIFICATIONS

XCS PILOT LIGHT ^③							
COVER WITH DEVICE	CATALOG NUMBER		HUB SIZE	DIAGRAM	LAMP VOLTS	LENS COLOR ^②	NAMEPLATE MARKING ^①
	COMPLETE UNITS (BOX & COVER)						
	DEAD-END	FEED-THRU					
XCS-0B24CL	XCS-1B24CL	XCS-4B24CL	1/2"		120V	Clear	Specify
	XCS-2B24CL	XCS-5B24CL	3/4"				
XCS-0B24GL	XCS-1B24GL	XCS-4B24GL	1/2"		120V	Green	Specify
	XCS-2B24GL	XCS-5B24GL	3/4"				
XCS-0B24RL	XCS-1B24RL	XCS-4B24RL	1/2"		120V	Red	Specify
	XCS-2B24RL	XCS-5B24RL	3/4"				

XCS DOUBLE PILOT LIGHT ^③							
COVER WITH DEVICE	CATALOG NUMBER		HUB SIZE	DIAGRAM	LAMP VOLTS	LENS COLOR ^②	NAMEPLATE MARKING ^①
	COMPLETE UNITS (BOX & COVER)						
	DEAD-END	FEED-THRU					
XCS-0B30CL	XCS-1B30CL	XCS-4B30CL	1/2"		120V	Clear	Specify
	XCS-2B30CL	XCS-5B30CL	3/4"				
XCS-0B30GL	XCS-1B30GL	XCS-4B30GL	1/2"		120V	Green	Specify
	XCS-2B30GL	XCS-5B30GL	3/4"				
XCS-0B30RL	XCS-1B30RL	XCS-4B30RL	1/2"		120V	Red	Specify
	XCS-2B30RL	XCS-5B30RL	3/4"				
XCS-0B30RL-GL	XCS-1B30RL-GL	XCS-4B30RL-GL	1/2"		120V	Red/Green	Specify
	XCS-2B30RL-GL	XCS-5B30RL-GL	3/4"				

XCS MOMENTARY CONTACT PUSH BUTTON AND PILOT LIGHT ^④								
COVER WITH DEVICE	CATALOG NUMBER		HUB SIZE	DIAGRAM	BUTTON COLOR	LENS COLOR ^②	NAMEPLATE MARKING ^①	
	COMPLETE UNITS (BOX & COVER)						BUTTON	LENS
	DEAD-END	FEED-THRU						
XCS-0B13-C	XCS-1B13-C	XCS-4B13-C	1/2"		Red	Red	Stop	Specify
	XCS-2B13-C	XCS-5B13-C	3/4"					
XCS-0B13-O	XCS-1B13-O	XCS-4B13-O	1/2"		Green	Red	Start	Specify
	XCS-2B13-O	XCS-5B13-O	3/4"					
XCS-0B13-U	XCS-1B13-U	XCS-4B13-U	1/2"		Black	Red	Specify	Specify
	XCS-2B13-U	XCS-5B13-U	3/4"					

XCS MOMENTARY CONTACT TWO MINI PUSH BUTTONS AND PILOT LIGHT ^④								
COVER WITH DEVICE	CATALOG NUMBER		HUB SIZE	DIAGRAM	BUTTON COLOR	LENS COLOR ^②	NAMEPLATE MARKING ^①	
	COMPLETE UNITS (BOX & COVER)						BUTTON	LENS
	DEAD-END	FEED-THRU						
XCS-0A15	XCS-1A15	XCS-4A15	1/2"		Red	Red	Stop	Specify
	XCS-2A15	XCS-5A15	3/4"					

① For other than standard marking, refer to the special feature section of price list.

② Lens color suffix listed in modifications page C18. Unless different lens colors are specified by proper suffix catalog number, red lens will be provided.

③ Pilot light transformers also listed in modifications. Add suffix to cover assembly catalog number.

④ Pilot light transformers will not fit in these assemblies. When transformer is desired, use SWB-14, indicating conduit openings required from chart on page C20 of this section. See page C18 for required transformer suffix. One transformer required for each lamp.

For control stations with 1" conduit openings or for multi-gang assemblies, order cover and box as separate components.





Selector Switch



Key Operated

**Class I, Div. 1 & 2, Groups C,D
Class I, Zones 1 & 2, Groups IIB, IIA
Class II, Div. 1 & 2, Groups E,F,G
Class III
NEMA 7 (C,D) 9(E,F,G)**

Listed - File E53360

Certified - File LR11714

See files for details or call Killark.

FEATURES-SPECIFICATIONS

XCS TWO POSITION SELECTOR SWITCH (MAINTAINED)*									
CATALOG NUMBER			HUB SIZE	TWO POSITION DIAGRAM				NAMEPLATE MARKING ①	
COVER WITH DEVICE	COMPLETE UNITS (BOX & COVER)			LEFT POSITION		RIGHT POSITION			
	DEAD-END	FEED-THRU		LEFT BLOCKS	RIGHT BLOCKS	LEFT BLOCKS	RIGHT BLOCKS		
XCS-0S2A1	XCS-1S2A1	XCS-4S2A1	1/2"					OFF/ON	
	XCS-2S2A1	XCS-5S2A1	3/4"						
XCS-0S2A5②	XCS-42S2A5	XCS-45S2A5	3/4"					OFF/ON	

XCS THREE POSITION SELECTOR SWITCH (MAINTAINED)*										
CATALOG NUMBER			HUB SIZE	THREE POSITION DIAGRAM						NAMEPLATE MARKING
COVER WITH DEVICE	COMPLETE UNITS (BOX & COVER)			LEFT POSITION		CENTER POSITION		RIGHT POSITION		
	DEAD-END	FEED-THRU		LEFT BLOCKS	RIGHT BLOCKS	LEFT BLOCKS	RIGHT BLOCKS	LEFT BLOCKS	RIGHT BLOCKS	
XCS-0S3C4	XCS-1S3C4	XCS-4S3C4	1/2"							HOA
	XCS-2S3C4	XCS-5S3C4	3/4"							
XCS-0S3C5②	XCS-42S3C5	XCS-45S3C5	3/4"							HOA

① For other than standard marking, refer to the special feature section of the price list.

② These sub-assemblies require deep style box SWB-14 or SWB-18 through SWB-49.

For control stations with 1" conduit openings or for multi-gang assemblies, order cover with devices and box as separate components.

XCS TWO POSITION KEY OPERATED SELECTOR SWITCH (MAINTAINED)*									
CATALOG NUMBER			HUB SIZE	TWO POSITION DIAGRAM				NAMEPLATE MARKING①	
COVER WITH DEVICE	COMPLETE UNITS (BOX & COVER)			LEFT POSITION		RIGHT POSITION			
	DEAD-END	FEED-THRU		LEFT BLOCKS	RIGHT BLOCKS	LEFT BLOCKS	RIGHT BLOCKS		
XCS-0K2A1D	XCS-1K2A1D	XCS-4K2A1D	1/2"					OFF/ON	
	XCS-2K2A1D	XCS-5K2A1D	3/4"						
XCS-0K2A5D②	XCS-42K2A5D	XCS-45K2A5D	3/4"					OFF/ON	

XCS THREE POSITION KEY OPERATED SELECTOR SWITCH (MAINTAINED)*										
CATALOG NUMBER			HUB SIZE	THREE POSITION DIAGRAM						NAMEPLATE MARKING
COVER WITH DEVICE	COMPLETE UNITS (BOX & COVER)			LEFT POSITION		CENTER POSITION		RIGHT POSITION		
	DEAD-END	FEED-THRU		LEFT BLOCKS	RIGHT BLOCKS	LEFT BLOCKS	RIGHT BLOCKS	LEFT BLOCKS	RIGHT BLOCKS	
XCS-0K3C4D	XCS-1K3C4D	XCS-4K3C4D	1/2"							HOA
	XCS-2K3C4D	XCS-5K3C4D	3/4"							
XCS-0K3C5D②	XCS-42K3C5D	XCS-45K3C5D	3/4"							HOA

① For other than standard marking, refer to the special feature section of the price list.

② These sub-assemblies require deep style box SWB-14 or SWB-18 through SWB-49.

For control stations with 1" conduit openings or for multi-gang assemblies, order cover with devices and box as separate components.

* Key removal in all positions for 2 & 3 position key operated selectors. Consult factory for variations.



KILLARK®



Selector Switch

Class I, Div. 1 & 2, Groups C,D
Class I, Zones 1 & 2, Groups IIB, IIA
Class II, Div. 1 & 2, Groups E,F,G
Class III
NEMA 7 (C,D) 9(E,F,G)

Listed - File E53360

Certified - File LR11714
See files for details or call Killark.

FEATURES-SPECIFICATIONS

XCS SPRING RETURN SELECTOR SWITCH Two Position Spring Return to Left							
CATALOG NUMBER			HUB SIZE	TWO POSITION DIAGRAM			
COVER WITH DEVICE ①	COMPLETE UNITS (BOX & COVER)			LEFT POSITION		RIGHT POSITION	
	DEAD-END	FEED-THRU	LEFT BLOCK	RIGHT BLOCK	LEFT BLOCK	RIGHT BLOCK	
XCS-0S2L3F	XCS-42S2L3F	XCS-45S2L3F	3/4"				

XCS SPRING RETURN SELECTOR SWITCH Three Position Spring Return to Center From Right and Left									
CATALOG NUMBER			HUB SIZE	THREE POSITION DIAGRAM					
COVER WITH DEVICE ①	COMPLETE UNITS (BOX & COVER)			LEFT POSITION		CENTER POSITION		RIGHT POSITION	
	DEAD-END	FEED-THRU	LEFT BLOCK	RIGHT BLOCK	LEFT BLOCK	RIGHT BLOCK	LEFT BLOCK	RIGHT BLOCK	
XCS-0S3M6G	XCS-42S3M6G	XCS-45S3M6G	3/4"						

XCS SPRING RETURN SELECTOR SWITCH Three Position Spring Return to Center From Right, Maintain in Left									
CATALOG NUMBER			HUB SIZE	THREE POSITION DIAGRAM					
COVER WITH DEVICE ①	COMPLETE UNITS (BOX & COVER)			LEFT POSITION		CENTER POSITION		RIGHT POSITION	
	DEAD-END	FEED-THRU	LEFT BLOCK	RIGHT BLOCK	LEFT BLOCK	RIGHT BLOCK	LEFT BLOCK	RIGHT BLOCK	
XCS-0S3L6G	XCS-42S3L6G	XCS-45S3L6G	3/4"						

XCS SPRING RETURN SELECTOR SWITCH Three Position Spring Return to Center From Left, Maintain in Right									
CATALOG NUMBER			HUB SIZE	THREE POSITION DIAGRAM					
COVER WITH DEVICE ①	COMPLETE UNITS (BOX & COVER)			LEFT POSITION		CENTER POSITION		RIGHT POSITION	
	DEAD-END	FEED-THRU	LEFT BLOCK	RIGHT BLOCK	LEFT BLOCK	RIGHT BLOCK	LEFT BLOCK	RIGHT BLOCK	
XCS-0S3R6G	XCS-42S3R6G	XCS-45S3R6G	3/4"						

① All spring return assemblies must be installed on deep style box SWB-14 or SWB-18 through SWB-49.
For control stations with 1" conduit openings or for multi-gang assemblies, order cover with devices and box as separate components.



Key Operated

**Class I, Div. 1 & 2, Groups C,D
Class I, Zones 1 & 2, Groups IIB, IIA
Class II, Div. 1 & 2, Groups E,F,G
Class III
NEMA 7 (C,D) 9(E,F,G)**

 Listed - File E53360

 Certified - File LR11714
See files for details or call Killark.

FEATURES-SPECIFICATIONS

XCS KEY OPERATED SPRING RETURN SELECTOR SWITCH ① Two Position Spring Return to Left							
CATALOG NUMBER			HUB SIZE	TWO POSITION DIAGRAM			
COVER WITH DEVICE ②	COMPLETE UNITS (BOX & COVER)			LEFT POSITION		RIGHT POSITION	
	DEAD-END	FEED-THRU	LEFT BLOCK	RIGHT BLOCK	LEFT BLOCK	RIGHT BLOCK	
XCS-0K2L3F22D	XCS-42K2L3F22D	XCS-45K2L3F22D	3/4"				

XCS KEY OPERATED SPRING RETURN SELECTOR SWITCH ① Three Position Spring Return to Center From Right and Left									
CATALOG NUMBER			HUB SIZE	THREE POSITION DIAGRAM					
COVER WITH DEVICE ②	COMPLETE UNITS (BOX & COVER)			LEFT POSITION		CENTER POSITION		RIGHT POSITION	
	DEAD-END	FEED-THRU	LEFT BLOCK	RIGHT BLOCK	LEFT BLOCK	RIGHT BLOCK	LEFT BLOCK	RIGHT BLOCK	
XCS-0K3M6G32D	XCS-42K3M6G32D	XCS-45K3M6G32D	3/4"						

XCS KEY OPERATED SPRING RETURN SELECTOR SWITCH ① Three Position Spring Return to Center From Right, Maintain in Left									
CATALOG NUMBER			HUB SIZE	THREE POSITION DIAGRAM					
COVER WITH DEVICE ②	COMPLETE UNITS (BOX & COVER)			LEFT POSITION		CENTER POSITION		RIGHT POSITION	
	DEAD-END	FEED-THRU	LEFT BLOCK	RIGHT BLOCK	LEFT BLOCK	RIGHT BLOCK	LEFT BLOCK	RIGHT BLOCK	
XCS-0K3L6G32D	XCS-42K3L6G32D	XCS-45K3L6G32D	3/4"						

XCS KEY OPERATED SPRING RETURN SELECTOR SWITCH ① Three Position Spring Return to Center From Left, Maintain in Right									
CATALOG NUMBER			HUB SIZE	THREE POSITION DIAGRAM					
COVER WITH DEVICE ②	COMPLETE UNITS (BOX & COVER)			LEFT POSITION		CENTER POSITION		RIGHT POSITION	
	DEAD-END	FEED-THRU	LEFT BLOCK	RIGHT BLOCK	LEFT BLOCK	RIGHT BLOCK	LEFT BLOCK	RIGHT BLOCK	
XCS-0K3R6G32D	XCS-42K3R6G32D	XCS-45K3R6G32D	3/4"						

① All key operators are furnished keyed different.
If keyed alike is required substitute letter "A" for "D" at end of catalog number.
Keys are removable in left position selectors and in center position for 3 position selectors.
For key removable in all positions change "22" in 2 position to "20" and "32" in 3 position to "30".
② All spring return assemblies must be installed on deep style box SWB-14 or SWB-18 through SWB-49.
For control stations with 1" conduit openings or for multi-gang assemblies, order cover with devices and box as separate components.



X-10
Blank Cover



Standard
Push Button
(Mushroom)



Miniature
Push Button

X BLANK AND SPECIAL COVERS	
CAT. NO.	DESCRIPTION
X-10	Blank cover
X-60	Cover with (1) 3/4" NPSM Hole [ⓐ]
X-64	Cover with (2) 3/4" NPSM Holes [ⓐ] [ⓑ]

[ⓐ] For "G" series short operators.
[ⓑ] When X-64 cover is used, one operator must be a pilot light due to electrical clearances.

STANDARD PUSH BUTTON ASSEMBLY (1-3/8" DIAMETER)			MINIATURE PUSH BUTTON ASSEMBLY (3/4" DIAMETER)			
CATALOG NUMBER						SHROUD
RED	GREEN	BLACK	RED	GREEN	BLACK	
X01BR	X01BG	X01BK	X01AR	X01AG	X01AK	Full
X03BR	X03BG	X03BK	X03AR	X03AG	X03AK	Half
X05BR	—	—	—	—	—	Mushroom*

*1-1/2" diameter



Pilot Light

XCS PILOT LIGHT OPERATOR ASSEMBLY [ⓐ]				
CATALOG NUMBER				SHROUD
RED	GREEN	CLEAR	AMBER	
X021BR	X021BG	X021BC	X021BA	Standard



Standard
Lockout



Miniature
Lockout



Selector
Lockout



Hole Plug



Dust/Weather
Cap



GOM Lockout

ACCESSORIES						
PUSH BUTTON LOCKOUT [ⓐ]	SELECTOR LOCKOUT [ⓐ]	HOLE PLUG [ⓐ]	DUST/WEATHER CAP			DESCRIPTION
			RED	GREEN	BLACK	
XLOB	G0-567-LOK	XOBP	XDBR	XDBG	XDBB	Standard operator
XLOA	—	XOAP	—	—	—	Miniature operator

[ⓐ] Replacement only by qualified person. Operator is staked into position at factory. Removal may damage operator or cover threads.

CATALOG NUMBER GOMLOCK	
LOCKOUT FOR MAINTAINED PUSH BUTTON COVERS	
XCS-OMMR3	
FXCS-OMMR3	

XCS REPLACEMENT BLANK NAMEPLATES	
CATALOG NUMBER	DESCRIPTION
XCSNPPB	XCS/FXCS full size (standard) push button
XCSNPPBM	XCS/FXCS miniature push button
XCSNPPL	XCS/FXCS pilot light
XCSNPSS2	XCS/FXCS 2 position selector switch
XCSNPSS3	XCS/FXCS 3 position selector switch





**Incandescent
Filament Lamp**

INCANDESCENT LAMP CANDELABRA SCREW BASE		
CAT. NO.	VOLT	COLOR
0460051B	120V AC/DC	CLEAR
0460414B	24V AC/DC	CLEAR



LED Lamp

XCS-FXCS LED LAMPS		
CAT. NO.	VOLT	COLOR
XCSLED-R110	120 VAC	RED
XCSLED-G110	120 VAC	GREEN
XCSLED-A110	120 VAC	AMBER



**Incandescent
Filament Lamp**



LED Lamp

XCS-FXCS LAMPS			
CAT. NO.	LAMP TYPE	VOLTS AC/DC	COLOR
YOSY24MB	FILAMENT	24	CLEAR
YOSY120MB	FILAMENT	120	CLEAR
GOLED-A110	LED	110	AMBER
GOLED-G110	LED	110	GREEN
GOLED-R110	LED	110	RED
GOLED-A24	LED	24	AMBER
GOLED-G24	LED	24	GREEN
GOLED-R24	LED	24	RED

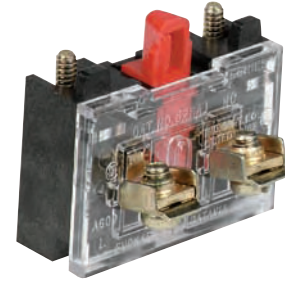

Contact Block

STANDARD CONTACT BLOCKS	
CAT. NO.	DESCRIPTION
GO-8672-BJK	1 N.O.
GO-8672-BJJ	1 N.O.
GO-8672-BJH	1 N.O. Early Make
GO-8672-BJE	1 N.C. Late Make

CONTACT BLOCKS FOR XCS SERIES CATALOG NUMBERS ENDING WITH B4-U, B7, A8 OR A9	
CAT. NO.	DESCRIPTION
YOWE-OT2B	1 N.O.
YOWE-OT2D	1 N.C.

CONTACT BLOCK FOR FXCS SERIES CATALOG NUMBERS ENDING WITH B-13U	
CAT. NO.	DESCRIPTION
GO-8672-PTCH	(1) N.O. (1) N.C.

CONTACT BLOCK FOR FXCS SERIES CATALOG NUMBERS ENDING WITH B4-U, B7, A5, C5	
CAT. NO.	DESCRIPTION
GO-8672-PTCC	(2) N.O. (2) N.C.





XS-3C

**Class I, Div. 1 & 2, Groups C,D
Class I, Zones 1 & 2, Groups IIB, IIA
Class II, Div. 1 & 2, Groups E,F,G
Class III
NEMA 7(C,D) 9(E,F,G)**

-  Listed - FILE E53360
 -  Certified - File LR11712
 -  File OP7A5.AE
- See files for details or call Killark.

FEATURES-SPECIFICATIONS

Applications

Used where making, breaking, or changing connections in an electric circuit are required.

Features

XS Series are front lever rotary operated switch assemblies with standard provisions for padlocking in either “ON” or “OFF” position. The lever is connected to a threaded stainless steel shaft which passes through the cover.

XS TUMBLER SWITCH						
COVER		CATALOG NUMBER			SWITCH STYLE	SWITCH RATING 120/277 VAC, 1Ø
WITH DEVICE	WITHOUT DEVICE	HUB SIZE	COMPLETE UNITS (BOX, COVER AND SWITCH)			
			DEAD-END	FEED-THRU		
XS-1C	XNS-1C	1/2" 3/4"	XS-11C XS-21C	XS-41C XS-51C	1-POLE	20A [Ⓜ]
XS-2C	XNS-2C	1/2" 3/4"	XS-12C XS-22C	XS-42C XS-52C	2-POLE	20A [Ⓜ]
XS-8C	XNS-8C	1/2" 3/4"	XS-18C XS-28C	XS-48C XS-58C	3-POLE	①
XS-3C	XNS-3C	1/2" 3/4"	XS-13C XS-23C	XS-43C XS-53C	3-WAY/ SPDT No center off	20A [Ⓜ]
XS-5C	XNS-5C	1/2" 3/4"	XS-15C XS-25C	XS-45C XS-55C	SPDT Center off	20A [Ⓜ]
XS-6C	XNS-6C	1/2" 3/4"	XS-16C XS-26C	XS-46C XS-56C	DPDT No center off	20A [Ⓜ]
XS-7C	XNS-7C	1/2" 3/4"	XS-17C XS-27C	XS-47C XS-57C	DPDT Center off	20A [Ⓜ]
XS-1D	XNS-1D	1/2" 3/4"	XS-11D XS-21D	XS-41D XS-51D	1-POLE	30A [Ⓜ]
XS-2D	XNS-2D	1/2" 3/4"	XS-12D XS-22D	XS-42D XS-52D	2-POLE	30A [Ⓜ]
XS-4C	—	—	—	—	4-WAY	20A [Ⓜ]

① Rated 15 amperes, 240/480 VAC., 3Ø: 3HP-240 VAC., 5 HP-480 VAC.
[Ⓜ] Horsepower rated 1 HP at 120VAC, 2 HP at 240VAC.



XAL
Pull Ring



XAS
Break Glass

Class I, Div. 1 & 2, Groups C,D
Class I, Zones 1 & 2, Groups IIB, IIA
Class II, Div. 1 & 2, Groups E,F,G
Class III
NEMA 7(C,D) 9(E,F,G)

FEATURES-SPECIFICATIONS

Applications

- Hazardous areas due to the presence of flammable gases or vapors, combustible dusts or easily ignitable fibers or flyings
- Installation at petroleum refineries, chemical and petrochemical plants, storage areas, and other processing facilities where hazardous substances are handled or stored
- Areas where emergency control of fire alarm or signal circuits is required

Features

- Enclosure is made of copper free aluminum alloy
- Conduit openings are 3/4" NPT feed through
- Red, textured powder epoxy paint finish is standard on box and cover and provides high visibility for alarm station
- XAL-458 has (2) normally open and (2) normally closed contacts.
- Bilingual nameplates included per CSA requirement
- Internal ground screw is standard

Operation

XAL: The alarm station is activated by lifting the front cover and pulling down ring. This quick, easy to use two-step process prevents unintentional operation. Operator is reset by depressing shaft and returning plate to original position.

XAL Series:

- Listed - File E50498
- Listed - CE69
- Certified - File LR31085
- Listed - California State Fire Marshall #7150-1439:100

XAS: Breaking glass with hammer provided activates alarm. Reset by replacing glass.

Replacement glass catalog number **YOKK-15214**.

Replacement hammer and chain **KIT-232**.

XAS Series:

- Listed - File E50498
- Certified - File LR31085
See files for details or call Killark.

XAL FIRE ALARM STATION		
CATALOG NUMBER	OPERATION TYPE	CONTACT BLOCKS
XAL-53	Pull ring	(1) NO/NC
XAL-458	Pull ring	(2) NO/NC
XAS-53	Break glass	(1) NO/NC

CONTACT BLOCK RATING								
AC						DC		
VOLTS	MAKE AMPERES	VA	BREAK AMPERES	VA	CONTINUOUS CARRYING AMPERES	VOLTS	MAKE BREAK	CONTINUOUS CARRYING AMPERES
120	60	7200	6	720	10	125	1.1	2.5
240	30	7200	3	720	10	250	0.55	2.5
480	15	7200	1.5	720	10	600	0.2	2.5
600	12	7200	1.2	720	10	—	—	—

Dimensions

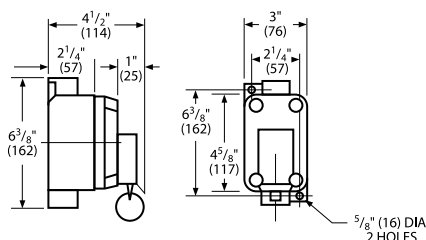

XAL-53

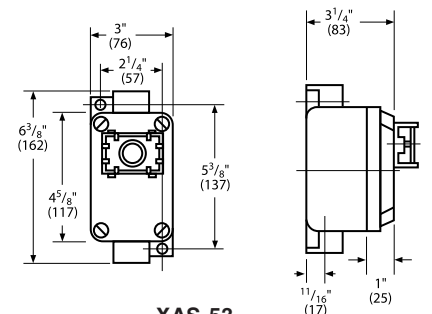

XAS-53

Note: On XAL-458 the overall depth is 5-9/16"





Class I, Div. 1 & 2, Groups B,C,D
Class I, Zones 1 & 2, Groups IIB, IIA
Class II, Div. 1 & 2, Groups E,F,G
Class III
NEMA 3, 4, 4X, 7(B,C,D) 9(E,F,G)

See Area Classification Chart below

FEATURES-SPECIFICATIONS

Applications

G Series custom control panel operators are designed for use in hazardous locations when installed in suitable enclosures such as B7E EXB, XJB, DB, SWB and GCS Series boxes and B7, Y7 Starter Enclosures.

Features

- Operators are all aluminum except for certain movable parts which are stainless steel, all other parts such as screws are either stainless steel or plated steel
- Threaded bodies are all 3/4"-14 NPSM thread
- Control stations can be grouped into a single assembly thus reducing installation time and cost
- Junction boxes may be used to mount operators along with glass lens for viewing internally mounted meters. Additional relays, timers, terminal blocks, or other equipment may also be internally mounted to provide a single centralized control unit.
- Custom operators other than standard assemblies listed may be ordered by proper catalog number from custom operator ordering system pages C40 & C41

Electrical Rating

Push button stations, selector switches Heavy duty 600 VAC max.
 Pilot lights 120 VAC.

Dimensions

See Dimensional information for G Series operators on page C42.

Recommended Operator Selection

Short Style

DB/SWB/GCS Enclosures. Assemblies with wall thickness up to 1/2" thick.

Long Style

All B7E/XJB Enclosures. EXB (see page E12) enclosures with cover thickness up to 1-1/2" thick.

Extended Style

EXB larger size enclosures (see page E12) with cover thickness up to 2-1/2" thick.

Killark long and extended push buttons, selector switches, reset and

potentiometer operators are CEN-ELEC/ATEX EExd IIB+H2 when installed in series EXB*CEN and GR*CEN enclosures.

For pilot lights and illuminated push buttons in CENELEC/ATEX applications see page C33.

CONTACT BLOCK RATINGS						
CURRENT	120 VAC	240 VAC	480 VAC	600 VAC	125 VDC	250 VDC
Inrush	60	30	15	12	.55	.275
Breaking	6	3	1.5	1.2	.55	.275
Carrying	10	10	10	10	2.50	2.50

Note: Contact blocks can be stacked four deep maximum.

AREA CLASSIFICATION CHART FOR OPERATORS					
G01④	G017②	G030②	G057②	G0L2④	G0L38③
G02④	G018②	G034②	G058②	G0L3④	G0L39③
G05④	G019②	G035② G036③	G059②	G0L4④	G0L113③
G06④	G021②	G037③	G0113③	G0L5④	G0L114③
G07④	G022②	G038③	G0114③	G0L6④	G0LRST④
G08③	G023②	G039③	G0133②	G0L7④ G0L8③	G0M1⑤
G010④	G025②	G040①	G0134②	G0L14④	G0R11④
G014④	G026②	G050②	G0B3④	G0L15④	G0RST④
G015④	G027②	G051②	G0B4④	G0L36③	G011388②
G016②	G028②	G056②	G0L1④	G0L37④	G011372②

① Class II Div. 1 & 2 Group EFG NEMA 9EFG
 ② Class I Div. 1 & 2 Group CD, Class II Div. 1 & 2 Group EFG, Class III NEMA 7CD, 9EFG
 ③ Class I Div. 1 & 2 Group BCD, Class II Div. 1 & 2 Group EFG, Class III NEMA 3, 4, 7BCD, 9EFG
 ④ Class I Div. 1 & 2 Group BCD, Class II Div. 1 & 2 Group EFG, Class III NEMA 3, 4, 4X, 7BCD, 9EFG
 ⑤ Class I Div. 1 & 2 Group CD, Class II Div. 1 & 2 Group EFG, Class III NEMA 3, 4, 7CD, 9EFG



Single Push Button
Long



Single Push Button
Extended



"G" Series Operator
Maintained



Double Push Button

Class I, Div. 1 & 2, Groups B,C,D^①
Class I, Zones 1 & 2, Groups IIB, IIA
Class II, Div. 1 & 2, Groups E,F,G
Class III
NEMA 3, 4, 4X, 7(B,C,D) 9(E,F,G)

See Area Classification Chart
page C40 for Details

Listed - File E12379

Certified - File LR11714
See files for details or call Killark.

FEATURES-SPECIFICATIONS

G SINGLE PUSH BUTTON (MOMENTARY CONTACT)					
CATALOG NUMBER ^①			COLOR	CONTACT TYPE ^③	NAMEPLATE MARKING ^②
SHORT ^④	LONG	EXTENDED			
G021-GZ1B	G01-GX1B N34	GOL1G1	Green		Start or Stop
G021-KZ1C	G01-KX1C N34	GOL1K1	Black		Reset or Blank
G021-RZ2B	G01-RX2B N34	GOL1R2	Red		Start or Stop
G021-KZ2C	G01-KX2C N34	GOL1K2	Black		Reset or Blank
G021-GZ3C	G01-GX3C N34	GOL1G3	Green		Reset or Blank
G021-RZ3C	G01-RX3C N34	GOL1R3	Red		Reset or Blank
G021-KZ3C	G01-KX3C N34	GOL1K3	Black		Reset or Blank
G021-GZ0C	G01-GX0C N34	GOL1G	Green	None	Reset or Blank
G021-RZ0C	G01-RX0C N34	GOL1R	Red		Reset or Blank
G021-KZ0C	G01-KX0C N34	GOL1K	Black		Reset or Blank

G SINGLE PUSH BUTTON (MAINTAINED CONTACT) MUSHROOM HEAD PUSH - PULL OPERATION					
GOM21-GM3C	GOM1-GM3C N34	GOML1G3	Green		Blank
GOM21-RM3C	GOM1-RM3C N34	GOML1R3	Red		Blank
GOM21-KM3C	GOM1-KM3C N34	GOML1K3	Black		Blank
GOM21-GM0C	GOM1-GM0C N34	GOML1G	Green	None	Blank
GOM21-RM0C	GOM1-RM0C N34	GOML1R	Red		Blank
GOM21-KM0C	GOM1-KM0C N34	GOML1K	Black		Blank

G DOUBLE PUSH BUTTON (MOMENTARY CONTACT)					
G022-GR12D	G02-GR12D N34	GOL2GR12	Green/Red		Start/Stop or Blank
G022-KK12D	G02-KK12D N34	GOL2KK12	Black/Black		Start/Stop or Blank
G022-GR33D	G02-GR33D N34	GOL2GR33	Green/Red		Start/Stop or Blank
G022-KK33D	G02-KK33D N34	GOL2KK33	Black/Black		Start/Stop or Blank
G022-GR00D	G02-GR00D N34	GOL2GR	Green/Red	None	Start/Stop or Blank
G022-KK00D	G02-KK00D N34	GOL2KK	Black/Black		Start/Stop or Blank

G DOUBLE PUSH BUTTON (MAINTAINED CONTACT) ^⑤					
—	GOR11-GR6D N34	—	Green/Red		Start/Stop or Blank
—	GOR11-GR7D N34	—	Green/Red		Start/Stop or Blank
—	GOR11-GR8D N34	—	Green/Red		Start/Stop or Blank
—	GOR11-GR0D N34	—	Green/Red	None	Start/Stop or Blank

^① Refer to catalog page C30 to select proper operator for enclosure, pages C38 & C39 for accessories, page C30 for complete details on Area Classification of operators, page C42 for Dimensional information.

^② Nameplates are double sided.

^③ Contact Blocks are shown in their normal position.

^④ Short style operators are suitable for Class I Group C & D, Class II Group E,F,G only.

^⑤ When pressed, the green button will remain in a depressed position. Pressing red button releases green from the depressed position.



KILLARK

Class I, Div. 1 & 2, Groups B,C,D[Ⓢ]
Class I, Zones 1 & 2, Groups IIB, IIA
Class II, Div. 1 & 2, Groups E,F,G
Class III
NEMA 3, 4, 4X, 7(B,C,D) 9(E,F,G)

See Area Classification Chart
page C40 for Details

 Listed - File E12379

 Certified - File LR11714
See files for details or call Killark.



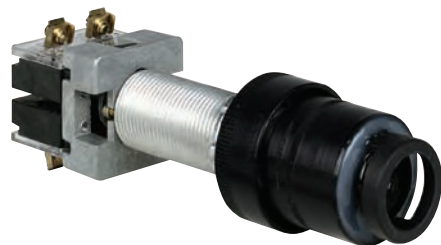

Pilot Light







Illuminated Button

FEATURES-SPECIFICATIONS

G PILOT LIGHTS					
CATALOG NUMBER [Ⓢ]			COLOR	CONTACT TYPE [Ⓢ]	NAMEPLATE MARKING [Ⓢ]
SHORT [Ⓢ]	LONG	EXTENDED			
G023-A23C	GOB3-A23C N34	GOL3A	Amber	 110-120 Volts Full Volts	Blank
G023-B23C	GOB3-B23C N34	GOL3B	Blue		Blank
G023-C23C	GOB3-C23C N34	GOL3C	Clear		Blank
G023-F23C	GOB3-F23C N34	GOL3F	Frosted		Blank
G023-G23C	GOB3-G23C N34	GOL3G	Green		Blank
G023-R23C	GOB3-R23C N34	GOL3R	Red		Blank

G PILOT LIGHTS WITH LED 110 VOLT LAMPS					
—	GOB3-A23C N34 LED	GOL3A LED	Amber	 110-120 Volts Full Volts (LED)	Blank
—	GOB3-G23C N34 LED	GOL3G LED	Green		Blank
—	GOB3-R23C N34 LED	GOL3R LED	Red		Blank

G ILLUMINATED BUTTON OR PUSH TO TEST PILOT LIGHT					
—	GOB4-A233C N34	GOL4A3	Amber	 110-120 Volts Full Volts	Blank
—	GOB4-B233C N34	GOL4B3	Blue		Blank
—	GOB4-C233C N34	GOL4C3	Clear		Blank
—	GOB4-F233C N34	GOL4F3	Frosted		Blank
—	GOB4-G233C N34	GOL4G3	Green		Blank
—	GOB4-R233C N34	GOL4R3	Red		Blank
—	GOB4-A230C N34	GOL4A	Amber	 110-120 Volts No Contact Blocks	Blank
—	GOB4-B230C N34	GOL4B	Blue		Blank
—	GOB4-C230C N34	GOL4C	Clear		Blank
—	GOB4-F230C N34	GOL4F	Frosted		Blank
—	GOB4-G230C N34	GOL4G	Green		Blank
—	GOB4-R230C N34	GOL4R	Red		Blank

G ILLUMINATED BUTTON OR PUSH TO TEST PILOT LIGHT WITH LED 110 VOLT LAMPS					
—	GOB4-A233C N34 LED	GOL4A3 LED	Amber	 110-120 Volts Full Volts (LED)	Blank
—	GOB4-G233C N34 LED	GOL4G3 LED	Green		Blank
—	GOB4-R233C N34 LED	GOL4R3 LED	Red		Blank
—	GOB4-A230C N34 LED	GOL4A LED	Amber	 110-120 Volts (LED) No Contact Blocks	Blank
—	GOB4-G230C N34 LED	GOL4G LED	Green		Blank
—	GOB4-R230C N34 LED	GOL4R LED	Red		Blank

[Ⓢ] Refer to catalog page C30 to select proper operator for enclosure, pages C38 & C39 for accessories, page C30 for complete details on Area Classification of operators, page C42 for Dimensional information.

[Ⓢ] Nameplates are double sided.

[Ⓢ] Contact Blocks are shown in their normal position.

[Ⓢ] Short style operators are suitable for Class I Group C & D, Class II Group E,F,G only.





Pilot Light ATEX



Illuminated Push Button ATEX

Class I, Div. 1 & 2, Groups B,C,D
 Class I, Zones 1 & 2, Groups IIB+H₂, IIA
 Class II, Div. 1 & 2, Groups E,F,G
 Class III
 NEMA 3, 4, 4X, 7(B,C,D) 9(E,F,G)
 ATEX-EEExd IIB + H2

Listed - File E12379

Certified - File LR11714

PTB No. 03ATEX 1203 U

FEATURES-SPECIFICATIONS

G PILOT LIGHTS				
CATALOG NUMBER ^①		COLOR	CONTACT TYPE ^③	NAME PLATE MARKING ^②
LONG	EXTENDED			
GOB3-A23C N34CN	GOL3ACN	Amber	 110-120 Volts Full Volts	Blank
GOB3-B23C N34CN	GOL3BCN	Blue		Blank
GOB3-C23C N34CN	GOL3CCN	Clear		Blank
GOB3-F23C N34CN	GOL3FCN	Frosted		Blank
GOB3-G23C N34CN	GOL3GCN	Green		Blank
GOB3-R23C N34CN	GOL3RCN	Red		Blank

G PILOT LIGHTS WITH LED 110 VOLT LAMPS				
GOB3-A23C N34LEDCN	GOL3ALEDCN	Amber	 110-120 Volts Full Volts (LED)	Blank
GOB3-G23C N34LEDCN	GOL3GLEDCN	Green		Blank
GOB3-R23C N34LEDCN	GOL3RLEDCN	Red		Blank

G ILLUMINATED PUSH BUTTON OR PUSH TO TEST PILOT LIGHT				
GOB4-A233CN34CN	GOL4A3CN	Amber	 110-120 Volts Full Volts	Blank
GOB4-B233CN34CN	GOL4B3CN	Blue		Blank
GOB4-C233CN34CN	GOL4C3CN	Clear		Blank
GOB4-F233CN34CN	GOL4F3CN	Frosted	 110-120 Volts No Contact Blocks	Blank
GOB4-G233CN34CN	GOL4G3CN	Green		Blank
GOB4-R233CN34CN	GOL4R3CN	Red		Blank
GOB4-A230CN34CN	GOL4A0CN	Amber	 110-120 Volts No Contact Blocks	Blank
GOB4-B230CN34CN	GOL4B0CN	Blue		Blank
GOB4-C230CN34CN	GOL4C0CN	Clear		Blank
GOB4-F230CN34CN	GOL4F0CN	Frosted		Blank
GOB4-G230CN34CN	GOL4G0CN	Green		Blank
GOB4-R230CN34CN	GOL4R0CN	Red		Blank

G ILLUMINATED PUSH BUTTON OR PUSH TO TEST PILOT LIGHT WITH LED 110 VOLT LAMPS				
GOB4-A233CN34LEDCN	GOL4A3LEDCN	Amber	 110-120 Volts Full Volts (LED)	Blank
GOB4-G233CN34LEDCN	GOL4G3LEDCN	Green		Blank
GOB4-R233CN34LEDCN	GOL4R3LEDCN	Red		Blank
GOB4-A230CN34LEDCN	GOL4A0LEDCN	Amber	 110-120 Volts (LED) No Contact Blocks	Blank
GOB4-G230CN34LEDCN	GOL4G0LEDCN	Green		Blank
GOB4-R230CN34LEDCN	GOL4R0LEDCN	Red		Blank

^① Refer to catalog page C30 to select proper operator for enclosure, pages C38 & C39 for accessories, page C30 for complete details on Area Classification of operators, page C42 for Dimensional information.

^② Nameplates are double sided.

^③ Contact Blocks are shown in their normal position.

NOTE: British standards BSEN50014 and EN50018 have special marking and relamping demands that require modifications to the standard Killark Pilot Lights. Pilots lights and illuminated push buttons on this page must be used for enclosures that are modified to meet ATEX/CENELEC.

Class I, Div. 1 & 2, Groups B,C,D^①
Class I, Zones 1 & 2, Groups IIB, IIA
Class II, Div. 1 & 2, Groups E,F,G
Class III
NEMA 3, 4, 4X, 7(B,C,D) 9(E,F,G)

See Area Classification Chart
page C40 for Details

 Listed - File E12379

 Certified - File LR11714
See files for details or call Killark.











Selector Switch
Maintained Contact













Selector Switch
Spring Return

FEATURES-SPECIFICATIONS

G SELECTOR SWITCH MAINTAINED CONTACT				
CATALOG NUMBER ^①			CONTACT ARRANGEMENT ^②	TYPE OF OPERATION ^③
SHORT ^④	LONG	EXTENDED		
G025-2A3F	G05-2A3F N34	G0L52A3	Left  Right 	Two position
G025-3C3G	G05-3C3G N34	G0L53C3	Left  Center  Right 	Three position
G025-4H8H	G05-4H8H N34	G0L54H8	1  2  3  4 	Four position

G SELECTOR SWITCH MAINTAINED CONTACT WITHOUT CONTACTS				
G025-2A0F	G05-2A0F N34	G0L52A	None	Two position
G025-3C0G	G05-3C0G N34	G0L53C	None	Three position
G025-4H0H	G05-4H0H N34	G0L54H	None	Four position

G SELECTOR SWITCH SPRING RETURN				
G026-3F	G06-3F N34	G0L63	Left  Right 	Two position spring return to left
G027-6G	G07-6G N34	G0L76	Left  Center  Right 	Three position spring return to center from right or left
G034-6G	G014-6G N34	G0L146	Left  Center  Right 	Three position spring return to center from right, maintain in left
G035-6G	G015-6G N34	G0L156	Left  Center  Right 	Three position spring return to center from left, maintain in right

G SELECTOR SWITCH SPRING RETURN WITHOUT CONTACTS				
G026-0F	G06-0F N34	G0L6	None	Two position spring return to left
G027-0G	G07-0G N34	G0L7	None	Three position spring return to center from right or left
G034-0G	G014-0G N34	G0L14	None	Three position spring return to center from right, maintain in left
G035-0G	G015-0G N34	G0L15	None	Three position spring return to center from left, maintain in right

^① Refer to catalog page C30 to select proper operator for enclosure, C38 & C39 for Accessories, C30 for complete details on Area Classification of operators, C42 for Dimensional Information, C40 for Special Contact Configurations.

^② Nameplates are Double sided. 2 position marked ON-OFF and Blank on other side.

3 position marked HAND-OFF-AUTO and Blank on other side. 4 position is Blank.

^③ Contact Blocks are shown in their normal position.

^④ Short style operators are suitable for Class I Group C & D, Class II Group E,F,G only.



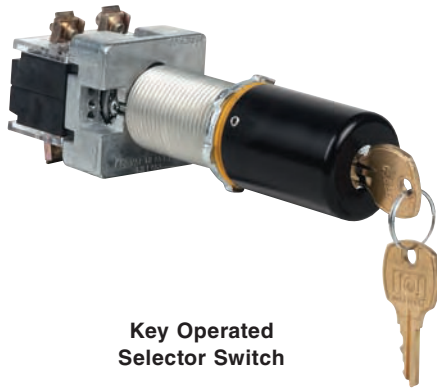

**Key Operated
 Selector Switch**

Class I, Div. 1 & 2, Groups B,C,D®
Class 1, Zones 1 & 2, Groups IIB, IIA
Class II, Div. 1 & 2, Groups E,F,G
Class III
NEMA 3, 4, 4X, 7(B,C,D) 9(E,F,G)



**See Area Classification Chart
 page C40 for Details**

 Listed - File E12379

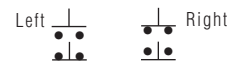

 Certified - File LR11714

See files for details or call Killark.

FEATURES-SPECIFICATIONS

G KEY SELECTOR SWITCH MAINTAINED CONTACT ④				
CATALOG NUMBER ①			CONTACT ARRANGEMENT ③	TYPE OF OPERATION ②⑤
SHORT ⑥	LONG	EXTENDED		
G028-2A3F22D	G08-2A3F22D N34	G0L82A322D		Two position
G028-3C3G32D	G08-3C3G32D N34	G0L83C332D		Three position

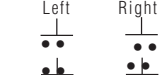
G KEY SELECTOR SWITCH MAINTAINED CONTACT WITHOUT CONTACTS ④				
G028-2A0F22D	G08-2A0F22D N34	G0L82A022D	None	Two position
G028-3C0G32D	G08-3C0G32D N34	G0L83C032D	None	Three position

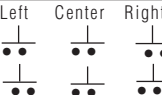
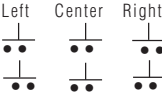
G KEY SELECTOR SWITCH SPRING RETURN ④				
G056-2L3F22D	G036-2L3F22D N34	G0L36L322D		Two position spring return to left
G057-3C6G32D	G037-3C6G32D N34	G0L37C632D		Three position spring return to center from right or left
G058-3L6G32D	G038-3L6G32D N34	G0L38L632D		Three position spring return to center from right, maintain in left
G059-3R6G32D	G039-3R6G32D N34	G0L39R632D		Three position spring return to center from left, maintain in right

G KEY SELECTOR SWITCH SPRING RETURN WITHOUT CONTACTS ④				
G056-2L0F22D	G036-2L0F22D N34	G0L36L022D	None	Two position spring return to left
G057-3C0G32D	G037-3C0G32D N34	G0L37C032D	None	Three position spring return to center from right or left
G058-3L0G32D	G038-3L0G32D N34	G0L38L032D	None	Three position spring return to center from right, maintain in left
G059-3R0G32D	G039-3R0G32D N34	G0L39R032D	None	Three position spring return to center from left, maintain in right

① Refer to catalog page C30 to select proper operator for enclosure, pages C38 & C39 for Accessories, page C30 for complete details on Area Classification of operators, page C42 for Dimensional Information, page C40 for Special Contact Configurations.

② Nameplates are Double sided. 2 position marked ON-OFF and Blank on other side. 3 position marked HAND-OFF-AUTO and Blank on other side. 4 position is Blank.

③ Contact Blocks are shown in their normal position.

④ All Key Operators are furnished Keyed Different If Keyed Alike is required substitute letter "A" for letter "D" in catalog number.

⑤ Keys are removable in Left position on 2 position selectors and in Center position on 3 position selectors. For key removal in ALL positions change "22" in 2 position to "20" and "32" in 3 position to "30".

⑥ Short style operators are suitable for Class I Group C & D, Class II Group E,F,G only.



Snap Switch



Potentiometer and Rheostat
(electrical device not included)



Reset



Rotary or Motor Shaft



Capillary Seal

Class I, Div. 1 & 2, Groups B,C,D^④
Class I, Zones 1 & 2, Groups IIB, IIA
Class II, Div. 1 & 2, Groups E,F,G
Class III
NEMA 3, 4, 4X, 7(B,C,D) 9(E,F,G)

See Area Classification Chart
page C40 for Details

Certified - File LR11714
See file for details or call Killark.

FEATURES-SPECIFICATIONS

G SNAP SWITCH OPERATOR					
CATALOG NUMBER ^①		TYPE SWITCH	RATINGS		NAMEPLATE MARKING ^②
SHORT ^④	LONG		125 VAC	250 VAC	
GO30-31F	GO10-31F N34	SPST	10 Amp	5 Amp	Off/On or Blank
GO30-33F	GO10-33F N34	SPDT (3-way)	10 Amp	10 Amp	Off/On or Blank

(UL File E10501)

G POTENTIOMETERS AND RHEOSTATS OPERATOR				
CATALOG NUMBER ^①			TYPE	DESCRIPTION ^①
SHORT ^④	LONG	EXTENDED		
GO133	GO113 N34	GOL113	Single turn	Control operator for use with potentiometers or rheostats having a 1/4" diameter by 7/8" long shaft.
GO134	GO114 N34	GOL114	Fifteen turn	

(UL File E150827)

G RESET OPERATOR				
CATALOG NUMBER ^①			NAMEPLATE ^③	TYPE OPERATION ^①
SHORT ^④	LONG	EXTENDED		
GO40-KX2C	GO-RST	GOLRST	Reset or Blank	Black plunger type reset operator, supplied with a 6" long fiber extension which can be removed or cut to desired length.

(UL File E150827)

G ROTARY OR MOTOR SHAFT OPERATOR			
CATALOG NUMBER ^①	SHAFT DIAMETER	TYPE	DESCRIPTION ^①
GO-16 ^⑤	1/4"	Male-Female	Rotary or motor shaft operator used to transfer rotary motion through wall of explosion proof enclosure.
GO-18 ^⑤	3/8"		
GO-17 ^⑤	1/4"	Male-Male	
GO-19 ^⑤	3/8"		
GO-50	1/2"		
GO-51	1/2"		

GO50 requires 1-1/4" NPSM opening (UL File E150827)

G CAPILLARY SEALS			
CATALOG NUMBER ^①	CAPILLARY SIZE	TYPE	DESCRIPTION ^①
GO-11388-078 ^⑤	0.078± .002 Dia.	Accepts Capillary With Max. Bulb Dia. of 9/16".	Use where a mechanical means for passing a thermostat or similar capillary tube through the wall of a hazardous location enclosure.
GO-11372-093 ^⑤	0.093± .002 Dia.		

^① Refer to catalog page C30 to select proper operator for enclosure, pages C38 & C39 for Accessories, page C30 for complete details on Area Classification of operators, page C42 for Dimensional Information.

^② Nameplates are double sided.

^③ GO40 series reset button is suitable for Class II E, F, and G locations only.

^④ Short style operators are suitable for Class I Group C & D, Class II Group E, F, G only.

^⑤ These devices are not UL or CSA approved.





Style 1 - GCS-16



Style 2 - GCS-163



Style 3 - SWBC-16

Class I, Div. 1 & 2, Groups C,D
Class I, Zones 1 & 2, Groups IIB, IIA
Class II, Div. 1 & 2, Groups E,F,G
Class III
NEMA 7(C,D) 9(E,F,G)
SWBC Series:

Listed - File E10514

Certified - File LR11716

See files for details or call Killark.

FEATURES-SPECIFICATIONS

GCS STYLE 1 - WITH DRILLED AND TAPPED OPERATOR HOLES IN COVER ①											
CATALOG NUMBER	NO. OF OPERATOR HOLES	CONSISTS OF		DIMENSIONS							
		BOX	COVER	A	B	C	D	E	G	H	I
GCS-13	1	SWB-13	X-60	6-1/8" (156)	2-3/8" (60)	5/16" (8)	5-3/16" (148)	3-5/8" (92)	—	3-1/2" (89)	2-9/16" (65)
GCS-14	1	SWB-14	X-60	6-1/8" (156)	2-3/8" (60)	5/16" (8)	5-1/4" (133)	3-5/8" (92)	—	4-5/16" (110)	3-3/8" (86)
GCS-15	2	SWB-15	X-61	7-3/8" (187)	3-1/8" (79)	5/16" (8)	6-1/2" (165)	4" (102)	1" (25)	4-1/4" (108)	3-1/4" (82)
GCS-16	3	SWB-16	X-62	9-3/8" (238)	3-3/16" (81)	5/16" (8)	8-1/2" (216)	4" (108)	2" (51)	4-1/4" (105)	3-1/4" (82)
GCS-83	4	SWB-83 ②	X-84	13" (330)	3-1/4" (82)	3/8" (10)	11-7/8" (302)	4-3/8" (111)	1-1/4" (32)	4-3/16" (106)	3-1/4" (82)
GCS-85	5	SWB-83 ②	X-85	13" (330)	3-1/4" (82)	3/8" (10)	11-7/8" (302)	4-3/8" (111)	2" (51)	4-3/16" (106)	3-3/16" (81)

GCS STYLE 2 - WITH DRILLED AND TAPPED OPERATOR HOLES IN BACK OF BOX ①											
CATALOG NUMBER	NO. OF OPERATOR HOLES	BOX	COVER	A	B	C	D	E	G	H	I
GCS-131	1	SWB-13	X-10	6-1/8" (156)	2-3/8" (60)	5/16" (8)	5-3/16" (148)	3-5/8" (92)	—	3-1/2" (89)	2-9/16" (65)
GCS-141	1	SWB-14	X-10	6-1/8" (156)	2-3/8" (60)	5/16" (8)	5-1/4" (133)	3-5/8" (92)	—	4-5/16" (110)	3-3/8" (86)
GCS-152	2	SWB-15	X-11	7-3/8" (187)	3-1/8" (79)	5/16" (8)	6-1/2" (165)	4" (102)	1" (25)	4-1/4" (108)	3-1/4" (82)
GCS-163	3	SWB-16	X-12	9-3/8" (238)	3-3/16" (81)	5/16" (8)	8-1/2" (216)	4" (102)	2" (51)	4-1/4" (108)	3-1/4" (82)
GCS-834	4	SWB-83 ②	X-83	13" (330)	3-1/4" (82)	3/8" (10)	11-7/8" (302)	4-3/8" (111)	1-1/4" (32)	4-3/16" (106)	3-1/4" (82)
GCS-835	5	SWB-83 ②	X-83	13" (330)	3-1/4" (82)	3/8" (10)	11-7/8" (302)	4-3/8" (111)	2" (51)	4-3/16" (106)	3-3/16" (81)

SWB STYLE 3 - BLANK BOX AND COVER - NO OPERATOR HOLES ①											
CATALOG NUMBER	NO. OF OPERATOR HOLES	BOX	COVER	A	B	C	D	E	G	H	I
SWBC-13	None	SWB-13	X-10	6-1/8" (156)	2-3/8" (60)	5/16" (8)	5-3/16" (148)	3-5/8" (92)	—	3-1/2" (89)	2-9/16" (65)
SWBC-14	None	SWB-14	X-10	6-1/8" (156)	2-3/8" (60)	5/16" (8)	5-1/4" (133)	3-5/8" (92)	—	4-5/16" (110)	3-3/8" (86)
SWBC-15	None	SWB-15	X-11	7-3/8" (187)	3-1/8" (79)	5/16" (8)	6-1/2" (165)	4" (102)	—	4-1/4" (108)	3-1/4" (82)
SWBC-16	None	SWB-16	X-12	9-3/8" (238)	3-3/16" (81)	5/16" (8)	8-1/2" (216)	4" (111)	—	4-1/4" (108)	3-1/4" (82)
SWBC-83	None	SWB-83 ②	X-83	13" (330)	3-1/4" (82)	3/8" (10)	11-7/8" (302)	4-3/8" (111)	—	4-3/16" (106)	3-3/16" (81)

① All GCS and SWBC Series are cataloged without conduit openings. Specify conduit size and location when ordering.

② GCS-83, GCS-834, and GCS-85, GCS-835 are provided with four mounting lugs.

Dimensions

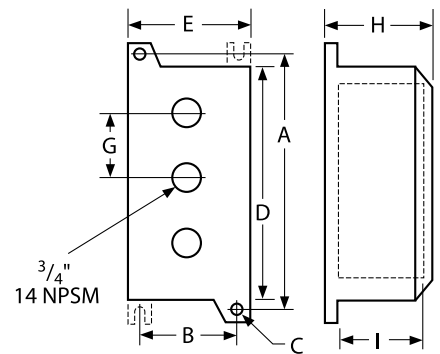

Notes: Use short style operators for cover devices and long style operators for back of box mounted devices when panel mounting.

Style 2 control stations with holes in back of box are typically used for panel mounting.





Rubber Boot



Hole Plug



Trim Locknut Spacer

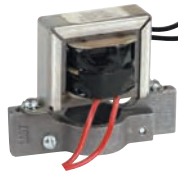

Transformer
GO-8670



Push Button Lockout
GO-8665



Push Button Lockout
GO-10502



Selector Switch Lockout



Reset Plate



Sealing Locknut
GO-RL

ACCESSORIES		
CATALOG NUMBER	USED ON OPERATOR TYPE	DESCRIPTION
GO-8176-1	G01, G021, GOL1	Protective rubber boot (Black)
GO-8176-2	G01, G021, GOL1	Protective rubber boot (Red)
GO-8176-3	G01, G021, GOL1	Protective rubber boot (Green)
GO-8177	3/4" NPSM	Hole plug
GO-8222	1/4" Thick, Used as external spacer.	Trim locknut spacer
GO-8670-32	G023, GOB3, GOL3	Transformer 220V-110V
GO-8670-34	G023, GOB3, GOL3	Transformer 440V-110V
GO-8671-42	GOB4, GOL4	Transformer 220V-110V
GO-8671-44	GOB4, GOL4	Transformer 440V-110V
GO-8665	G02, G022, GOL2, GOR11	Push button lockout
GO-10502	G01, G021, GOL1	Push button lockout
GO567-LOK	GO & GOL5-6-7-14-15-26-27-34-35	Selector switch lockout
GO-RL	For use with GO's	Sealing lockout
GO-9824	GO40, GO-RST, GOLRST	Reset plate
B7PLR220	G023, GOB3, GOL3, GOB4, GOL4	Resistor kit 220V-110V
B7PLR440	G023, GOB3, GOL3, GOB4, GOL4	Resistor kit 440V-110V
B7PLR550	G023, GOB3, GOL3, GOB4, GOL4	Resistor kit 550V-110V
GOLED-R110	GOB3, GOL3, GOB4, GOL4	LED lamps 120V (Red)
GOLED-G110	GOB3, GOL3, GOB4, GOL4	LED lamps 120V (Green)
GOLED-A110	GOB3, GOL3, GOB4, GOL4	LED lamps 120V (Amber)



Lens Guard Assembly

REPLACEMENT LENS GUARD ASSEMBLIES		
CATALOG NUMBER		LENS COLOR
GOL3/GOB3/G023 SERIES	GOL4/GOB4 SERIES	
GO15726-A	KIT-354	Amber
GO15726-B	KIT-355	Blue
GO15726-C	KIT-356	Clear
GO15726-F	KIT-357	Frosted
GO15726-G	KIT-358	Green
GO15726-R	KIT-359	Red

REPLACEMENT BLANK NAMEPLATES	
CATALOG NUMBER	DESCRIPTION
YOKK-9484-2	Push button pilot lights
YOKK-10291	Double push button
YOKK-10286	2 Position selector switch
YOKK-10287	3 Position selector switch
YOKK-10285	4 Position selector switch





GOMLOCK



**Standard Mushroom
Momentary**



**Jumbo Mushroom
Momentary**

ACCESSORIES		
CATALOG NUMBER	FOR USE ON OPERATOR TYPE	DESCRIPTION
GOMLOCK	GOM1-GOM21-GOML-G01-G021-GOL1	Lock Out for Standard Size Momentary & Maintained Head
GOMSTG	G01-G021-GOL1	Standard Size Momentary Mushroom Head (Green)
GOMSTR	G01-G021-GOL1	Standard Size Momentary Mushroom Head (Red)
GOMSTK	G01-G021-GOL1	Standard Size Momentary Mushroom Head (Black)
GOMJUR	G01-G021-GOL1	Jumbo Size Momentary Mushroom Head (Red)

Dimensions - Standard Mushroom - 1-1/2" Diameter

Jumbo Mushroom - 2-1/4" Diameter

**Replacement
Parts**



**Slide Base
GO23**



**Bayonet Base
GOL3/GOL4
GOB3/GOB4**



Contact Block

PILOT LIGHT LAMPS				
CATALOG NUMBER	VOLTS	WATTS	AMPS	STYLE
GO-8668-120	120	3	0.025	G023
GO-8668-24	24	1.7	0.073	
YOSY120MB	120	3	0.025	GOB3/GOL3
YOSY24MB	24	1.7	0.073	GOB4/GOL4

GO STANDARD CONTACT BLOCKS	
CATALOG NUMBER	DESCRIPTION
GO-8672-BJK	1 N.O.
GO-8672-BJJ	1 N.C.
GO-8672-BJH	1 N.O. Early make
GO-8672-BJE	1 N.C. Late break



LED Lamp for GOB3/GOL3 - GOB4/GOL4

PILOT LIGHT LED LAMPS		
CATALOG NUMBER	VOLTS	COLOR
GOLED-A110	110 VAC/DC	Amber
GOLED-B110	110 VAC/DC	Blue
GOLED-G110	110 VAC/DC	Green
GOLED-R110	110 VAC/DC	Red
GOLED-W110	110 VAC/DC	White
GOLED-A24	24 VAC/DC	Amber
GOLED-B24	24 VAC/DC	Blue
GOLED-G24	24 VAC/DC	Green
GOLED-R24	24 VAC/DC	Red
GOLED-W24	24 VAC/DC	White



Example: **G01** — **RX** **2** **B** **N34**
FORM **COLOR** **CONTACTS** **NAMEPLATE** **CONSTANT**
SINGLE PUSH BUTTON **(RED)** **(1 N.C.)** **(STOP)**
LONG STYLE

NOTE: For faster delivery on custom operators order push buttons and selector switches without contact blocks and order contacts as a separate item.

FEATURES-SPECIFICATIONS

1. Select operator form and style (short, long or extended).
2. Using the catalog numbering system below, insert the proper letter or number symbol as shown in appropriate charts on page C41, write the complete catalog number.
3. Spaces in catalog numbering system which have symbol already filled in cannot be changed.
4. Order accessories as separate item from pages C38 & C39.
5. Add "N34" suffix to the end of all long style operators with the following prefix; G01, G02, G0B3, G0B4, G05, G06, G07, G08, G010, G011, G014, G015, G036, G037, G038, G039.

CATALOG SERIES	COLOR	VOLTAGE	POSITION	CAM	CONTACTS	NAMEPLATE	KEY LOCK	KEY TYPE	DESCRIPTION
G01 & G021 GOL1	Chart 1				Chart 4	Chart 8			Single push button: (Momentary contact)
G0M1	Chart 1				Chart 4	Chart 8			Single push button: (Maintained contact)
G02 & G022 GOL2	Chart 2				Chart 4	Chart 8			Double push button: (Momentary contact)
GOR11	Chart 2				Chart 4	Chart 8			Double push button: (Maintained contact)
G0B3 & G023 GOL3	Chart 3	Chart 6				Chart 8			Pilot light
G0B4 GOL4	Chart 3	Chart 6			Chart 4	Chart 8			Illuminated push button
G05 & G025 GOL5			Chart 5	Chart 7	Chart 4	Chart 8			Selector switch (Maintained contact)
G06 & G026 GOL6					Chart 4	Chart 8			Selector switch (2 Position, spring return to left)
G07 & G027 GOL7					Chart 4	Chart 8			Selector switch (3 Position, return to center from center)
G014 & G034 GOL14					Chart 4	Chart 8			Selector switch (3 Position, return to center from right)
G015 & G035 GOL15					Chart 4	Chart 8			Selector switch (3 Position, return to center from left)
G08 & G028 GOL8			Chart 5	Chart 7	Chart 4	Chart 8	Chart 9	Chart 10	Key selector switch (Maintained contact)
G036 & G056 GOL36					Chart 4	Chart 8	Chart 9	Chart 10	Key selector switch (2 Position, spring return to left)
G037 & G057 GOL37					Chart 4	Chart 8	Chart 9	Chart 10	Key selector switch (3 Position, spring return to center)
G038 & G058 GOL38					Chart 4	Chart 8	Chart 9	Chart 10	Key selector switch (3 Position, return to center from right)
G039 & G059 GOL39					Chart 4	Chart 8	Chart 9	Chart 10	Key selector switch (3 Position, return to center from left)



CHART 1 – SINGLE BUTTON				
G01 SYMBOL	G021 SYMBOL	G0L1 SYMBOL	G0M1 SYMBOL	COLOR
KX	KZ	K	KM	Black
RX	RZ	R	RM	Red
GX	GZ	G	GM	Green

CHART 2 – DOUBLE BUTTON	
SYMBOL	COLOR
KK	Black/Black
GG	Green/Green
RR	Red/Red
RG	Red/Green
KR	Black/Red
KG	Black/Green

CHART 3 – PILOT LIGHT LENS	
SYMBOL	COLOR
A	Amber
B	Blue
C	Clear
F	Frosted
G	Green
R	Red

CHART 4 – CONTACT BLOCKS	
SYMBOL	ARRANGEMENT
1	One N.O. block
2	One N.C. block
3	One universal (One N.O. and one N.C.)
4	One delayed break N.C. block
5	One early make N.O. block
6	Two N.O. blocks
7	Two N.C. blocks
8	Two universal (Two N.O. and two N.C.)
0	Omit contact block

CHART 5 – SELECTOR SWITCHES	
SYMBOL	NO. OF POSITIONS
2	Two
3	Three

CHART 6 – PILOT LIGHT LAMPS		
G023 SYMBOL	GOB3/GOB4 SYMBOL	VOLTAGE
23	23	120
4	4	24

CHART 7A – SELECTOR SWITCH CAMS							
CAM AND CONTACT SELECTION TABLE FOR 2 AND 3 POSITION SELECTOR OPERATOR							
		Left position	Center position	Right position			
SYMBOL	CONTACTS BLOCKS	LEFT BLOCKS	RIGHT BLOCKS	LEFT BLOCKS	RIGHT BLOCKS	LEFT BLOCKS	RIGHT BLOCKS
A	NC	X	X			0	0
	NO	0	0			X	X
B	NC	X	0	X	X	0	X
	NO	0	X	0	0	X	0
C	NC	X	X	0	0	0	0
	NO	0	0	0	0	X	X
D	NC	0	0	X	X	0	0
	NO	0	0	0	0	X	X
E	NC	0	0	X	X	0	0
	NO	X	X	0	0	0	0
G	NC	X	0	0	X	0	0
	NO	0	0	0	0	X	X

Note: Spring return operators are supplied with special fixed cam. Changes cannot be made for cam substitution.

CHART 7B	
CAM	PART NUMBER
A	0106775B
B	11586ABAB
C	11587ABAB
D	11588ABAB
E	11589ABAB
G	11590ABAB

CHART 8 – NAMEPLATES [Ⓞ]			
SYMBOL	NAMEPLATE MARKINGS		G SERIES FORMS THAT NAMEPLATE CAN BE USED ON
	FRONT	BACK	
A	Omit nameplate	Omit nameplate	All
B	Start	Stop	G01, 21, 23, 20, 40, GOB3
C	Blank	Reset	G01, 21, 23, 20, 40, GOB3, GOB4
E	Blank	On	G0R4
F	Blank-Blank	Off-On	G05, 25, 6, 26, 8, 28, 10, 30, 36, 56
G	Blank-Blank-Blank	Hand-Off-Auto	G05, 25, 7, 27, 8, 28, 10, 30, 14, 34
H	Blank-Blank-Blank-Blank	Start-Stop	G05, 25, 10, 30

CHART 9 – KEY LOCK	
SYMBOL	TYPE
22	2 Position key remove left
20	2 Position key remove both
32	3 Position key remove center
30	3 Position key remove all

CHART 10 – KEY STYLE	
SYMBOL	TYPE
D	Keys different
A	Keys alike

[Ⓞ] Symbol not required on extended length GOL part number.

G DIMENSIONS					
SERIES	FIGURE	A	B	C	D
G01	1	15/16" (24)	1-3/4" (44)	3-7/16" (87)	1-1/4" (32)
G02	3	13/16" (21)	2" (51)	3-3/4" (95)	—
G0B3	4	1-1/8" (29)	2" (51)	2-3/4" (70)	1-9/16" (40)
G0B4	5	2-3/8" (60)	2-1/4" (57)	4" (101)	1-13/16" (46)
G05	9	1-5/16" (33)	1-3/4" (44)	3-7/16" (87)	1-1/4" (32)
G06,G07,G014,G015	9	1-5/16" (33)	1-3/4" (44)	3-13/16" (97)	1-1/4" (32)
G08	10	2-9/16" (65)	1-3/4" (44)	3-1/2" (89)	1-1/4" (32)
G010	11	1-5/16" (33)	1-3/4" (44)	4" (101)	1-1/4" (32)
G016,G018	7	1-1/4" (32)	1" (25)	13/16" (21)	1-1/2" (38)
G017,G019	7	13/16" (21)	1" (25)	13/16" (21)	1-1/2" (38)
G021	1	15/16" (24)	3/4" (19)	2-7/16" (62)	1-1/4" (32)
G022	3	13/16" (21)	1" (25)	2-3/4" (70)	—
G023	4	1-1/8" (29)	1" (25)	1-3/4" (44)	1-9/16" (40)
G025	9	1-5/16" (33)	3/4" (19)	2-7/16" (62)	1-1/4" (32)
G026,G027,G034,G035	9	1-5/16" (33)	3/4" (19)	2-13/16" (71)	1-1/4" (32)
G030	11	1-5/16" (33)	3/4" (19)	3" (76)	1-1/4" (32)
G036,G037,G038,G039	10	2-9/16" (65)	1-3/4" (44)	3-7/8" (98)	1-1/4" (32)
G040	2	15/16" (24)	11/16" (17)	1" (25)	1-1/4" (32)
G050	7	1-1/2" (38)	2" (51)	6-5/16" (160)	2-5/16" (59)
G051	7	2-1/4" (57)	1-5/8" (41)	5-9/16" (141)	1" (25)
G056,G057,G058,G059	10	2-9/16" (65)	3/4" (19)	2-7/8" (73)	1-1/4" (32)
G0113,G0114	6	1" (25)	2" (51)	3-5/8" (67)	1-13/16" (46)
G0133,G0134	6	1" (25)	1" (25)	2-5/8" (67)	1-13/16" (46)
GO-11388-078	8	1-5/16" (33)	3/4" (19)	N/A	1-1/2" (38)
GO-11372-093	8	1-5/16" (33)	3/4" (19)	N/A	1-1/2" (38)
G0R11	3	13/16" (21)	2" (51)	4-1/8" (105)	—
GO-RST	2	15/16" (24)	2-5/16" (59)	2-3/8" (+6") (60)	1-1/4" (32)
G0M1	1	1-7/8" (48)	1-7/16" (37)	4" (101)	1-5/8" (41)
EXTENDED LENGTH OPERATORS:					
G0L1	1	15/16" (24)	2-3/4" (70)	4-7/16" (113)	1-1/4" (32)
G0L2	3	13/16" (21)	2-3/4" (70)	4-1/2" (114)	—
G0L3	4	1-1/8" (29)	2-3/4" (70)	3-3/8" (86)	1-9/16" (40)
G0L4	5	2-3/8" (60)	2-3/4" (70)	4-5/8" (117)	1-13/16" (46)
G0L5	9	1-5/16" (33)	2-3/4" (70)	4-7/16" (113)	1-1/4" (32)
G0L6,G0L7,G0L14,G0L15	9	1-5/16" (33)	2-3/4" (70)	4-13/16" (122)	1-1/4" (32)
G0L8	10	2-9/16" (65)	2-3/4" (70)	4-1/2" (114)	1-1/4" (32)
G0L36,G0L37,G0L38,G0L	10	2-9/16" (65)	2-3/4" (70)	4-7/8" (124)	1-1/4" (32)
G0L113,G0L114	6	1" (25)	3" (76)	4-5/8" (117)	1-13/16" (46)
G0LRST	2	15/16" (24)	2-3/4" (70)	3" (+6") (76)	1-1/4" (32)

NOTE: All operators are for installation into a 3/4"-14 NPSM opening except GO50 which is for 1-1/4"-11-1/2 NPSM and GO-11388-078 + GO-11372-093 which are for use in a 3/4"-14 NPT opening.

Special Operators

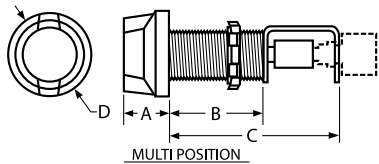

FIGURE 6

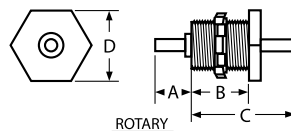

FIGURE 7

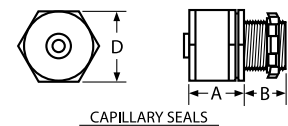

FIGURE 8

Selector Switches

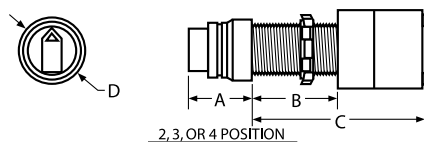

FIGURE 9

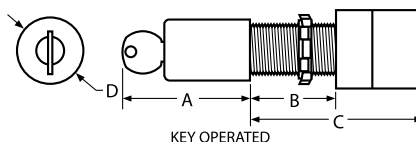

FIGURE 10

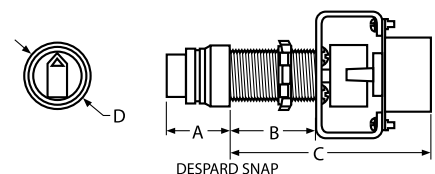

FIGURE 11

Push Buttons

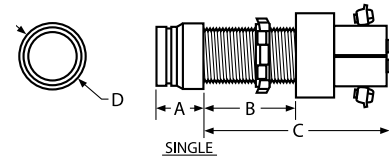

FIGURE 1

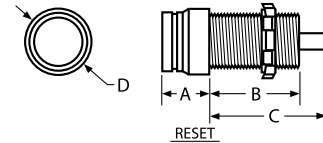

FIGURE 2

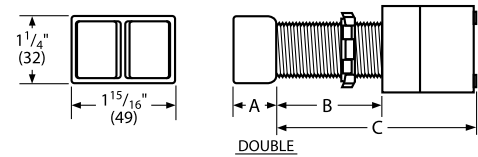

FIGURE 3

Pilot Lights

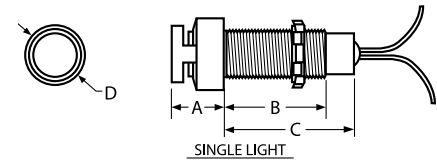

FIGURE 4

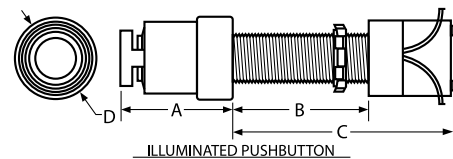

FIGURE 5





Line Starter



Combination Starter

Class I, Div. 1 & 2, Groups B,C,D
Class I, Zones 1 & 2, Groups IIB, IIA
Class II, Div. 1 & 2, Groups E,F,G
Class III, Div. 1 & 2
NEMA 3, 4, 4X, 7(B,C,D) 9(E,F,G)

 Classified - File E83969

 Certified - File LR11714
 See files for details or call Killark.

FEATURES-SPECIFICATIONS



Applications

The PRISM® B7 Series of across-the-line starter and combination motor control centers utilize SSNR single-speed, non-reversing NEMA type starters.

Prism enclosures universal design accommodates, as standard, the magnetic starters made by the following manufacturers:

- Allen-Bradley — 509 Series
- Cutler-Hammer — A10 Series
- Cutler-Hammer — AN16 Series
- Furnas — Class 14 Series
- GE — CR306 Series
- Square D — 8536 Series
- Telemecanique — A20 Series
- Westinghouse — A200 Series

In addition, the SSNR combination starters will house a motor circuit protector or circuit breakers manufactured by:

- Square D — FA, FH, FC Frames
- Cutler-Hammer — HMC, EHD, FDB, FD, HFD, FDC Frames
- General Electric — TEB-TEC-TED-THED-Frame

There is sufficient space in the combination starter enclosure for a control transformer, if required.

Standard Materials

Enclosure – Copper-free aluminum

O-ring Gasket – BUNA-N nitrile

Cover Bolts – 316 grade stainless steel

CB/MCP Handle – Copper-free aluminum

Reset Operator – Thermoplastic polyester button molded onto stainless steel shaft. Aluminum shroud.

Mounting Pan – Sheet aluminum

Hinge – Aluminum with stainless steel pin

Reset Shroud – Black anodized

Features

- Nema 4, 4X rated – providing protection from hose directed water and corrosion
- Universal mounting pan, pre-drilled to facilitate easy field installation of starters. Provision for grounding supplied as standard.
- More wiring room – meets latest NEC wire bend requirements
- Quick release, captivated cover bolts of 316 grade stainless steel
- Flange sealing gasket located to the inside of cover bolt – preventing water seepage into enclosure through bolt holes
- Hinged cover provided as standard for an extra measure of safety and convenience
- Breaker (MCP) handle can be pad-locked in “ON” or “OFF” position

- Provisions provided for drain and breather plus conduit openings for power and control
- Reset button provided as standard
- Two control operator openings provided plugged as standard. Additional openings can be factory or field drilled.
- Copper-free (less than 4/10 of 1% copper) enclosure
- Ductile mounting lugs

Catalog Logic

See page C48 for enclosures with controls.



Line Starter



Combination Starter

Class I, Div. 1 & 2, Groups B,C,D
Class I, Zones 1 & 2, Groups IIB, IIA
Class II, Div. 1 & 2, Groups E,F,G
Class III, Div. 1 & 2
NEMA 3, 4, 4X, 7(B,C,D) 9(E,F,G)

Classified - File E83969

Certified - File LR11714
See files for details or call Killark.

FEATURES-SPECIFICATIONS

Magnetic Line Starters - 3 Pole, 3 Phase, Single Speed Non Reversing 600 VAC Max, 60Hz

Square D or Cutler-Hammer motor starters available as standard. Heaters not included. See page C49 to order.

B7 MAGNETIC LINE STARTERS						
NEMA STARTER SIZE	MOTOR VOLTS	COIL VOLTS [Ⓢ]	MAX. HP	CATALOG NUMBER		ENCLOSURE ONLY NO INTERIORS
				CUTLER-HAMMER SERIES AN16	SQUARE D SERIES 8536	
0	SEP. CONTROL	120	—	B7010HB	B7010SB	B7011
0	230	240	3	B7010HG	B7010SG	
0	460	480	5	B7010HK	B7010SK	
0	575	600	5	B7010HM	B7010SM	
1	SEP. CONTROL	120	—	B7011HB	B7011SB	B7011
1	230	240	7-1/2	B7011HG	B7011SG	
1	460	480	10	B7011HK	B7011SK	
1	575	600	10	B7011HM	B7011SM	
2	SEP. CONTROL	120	—	B7012HB	B7012SB	B7012
2	230	240	15	B7012HG	B7012SG	
2	460	480	25	B7012HK	B7012SK	
2	575	600	25	B7012HM	B7012SM	
3	SEP. CONTROL	120	—	B7013HB	B7013SB	B7013
3	230	240	30	B7013HG	B7013SG	
3	460	480	50	B7013HK	B7013SK	
3	575	600	50	B7013HM	B7013SM	
4	SEP. CONTROL	120	—	B7014HB	B7014SB	B7014
4	230	240	50	B7014HG	B7014SG	
4	460	480	100	B7014HK	B7014SK	
4	575	600	100	B7014HM	B7014SM	

[Ⓢ] See catalog logic page C48 for other standard coil voltages.

[Ⓢ] Control transformers for use on Combination Starters Only. Will not fit into B701 Series of Non-Combination Starters.

[Ⓢ] See catalog page C48 for modifications and accessories to enclosure.



Combination Starters
3-Pole, 3-Phase, Single
Speed Non Reversing
600 VAC Max, 60Hz

Square D or Cutler-Hammer motor starters and motor circuit protector available. Heaters not included. See page C49 to order. Enclosure sized to accommodate control circuit transformer.

B7 COMBINATION MAGNETIC LINE STARTERS							
NEMA STARTER SIZE	MOTOR VOLTS	COIL VOLTS ^①	MAX. HP	DISCONNECT TRIP AMPS	CATALOG NUMBER		ENCLOSURE ONLY NO INTERIORS
					CUTLER-HAMMER SERIES AN16	SQUARE D SERIES 8536	
0	SEP. CONTROL	120	—	3	B7020HBCA	B7020SBAA	B7021
0	SEP. CONTROL	120	—	7	B7020HBCB	B7020SBAB	
0	SEP. CONTROL	120	—	15	B7020HBCC	B7020SBAC	
0	230	240	1	7	B7020HGCB	B7020SGAB	
0	230	240	3	15	B7020HGCC	B7020SGAC	
0	460	480	1	3	B7020HKCA	B7020SKAA	
0	460	480	2	7	B7020HKCB	B7020SKAB	
0	460	480	5	15	B7020HKCC	B7020SKAC	
0	575	600	1	3	B7020HMCA	B7020SMAA	
0	575	600	2	7	B7020HMCB	B7020SMAB	
0	575	600	5	15	B7020HMCC	B7020SMAC	
1	SEP. CONTROL	120	—	15	B7021HBCC	B7021SBAC	B7021
1	SEP. CONTROL	120	—	30	B7021HBCF	B7021SBAF	
1	230	240	7-1/2	30	B7021HGCF	B7021SGAF	
1	460	480	10	30	B7021HKCF	B7021SKAF	
1	575	600	10	30	B7021HMCF	B7021SMAF	
2	SEP. CONTROL	120	—	50	B7022HBCK	B7022SBAK	B7022
2	SEP. CONTROL	120	—	70	B7022HBCM	B7022SBAM	
2	230	240	15	50	B7022HGCK	B7022SGAK	
2	230	240	15	70	B7022HGCM	B7022SGAM	
2	460	480	25	50	B7022HKCK	B7022SKAK	
2	575	600	25	50	B7022HMCK	B7022SMAK	
3	SEP. CONTROL	120	—	100	B7023HBCQ	B7023SBAQ	B7023
3	230	240	30	100	B7023HGCK	B7023SGAQ	
3	460	480	50	100	B7023HKCQ	B7023SKAQ	
3	575	600	50	100	B7023HMCQ	B7023SMAQ	
4	SEP. CONTROL	120	—	150	B7024HBCT	B7024SBBT	B7024
4	230	240	50	150	B7024HGCT	B7024SGBT	
4	460	480	100	150	B7024HKCT	B7024SKBT	
4	575	600	100	150	B7024HMCT	B7024SMBT	
5	SEP. CONTROL	120	—	250	B7025CBCMCPJ250	B7025SBSMAGK250	See chart below
5	SEP. CONTROL	120	—	400	B7025CBCMCPK400	B7025SBSMAGL400	
5	230	240	75	250	B7025CGCMCPJ250	B7025SGSMAGK250	
5	230	240	100	400	B7025CGCMCPK400	B7025SGSMAGL400	
5	460	480	150	250	B7025CKCMCPJ250	B7025SKSMAGK250	
5	460	480	200	400	B7025CKCMCPK400	B7025SKSMAGL400	
5	575	600	150	250	B7025CMCMCPJ250	B7025SMSMAGK250	
5	575	600	200	400	B7025CMCMCPK400	B7025SMSMAGL400	

① See catalog logic page C48 for other standard coil voltages.

② Combination Starter enclosures provide sufficient space for factory of field mounting a control transformer.

③ See catalog page C48 for modifications and accessories to enclosure.

SIZE 5 COMBINATION MOTOR STARTER ENCLOSURE ONLY					
STARTER MANUFACTURER	STARTER TYPE	CIRCUIT BREAKER FRAME			ENCLOSURE CAT. NUMBER
		C-H	GE	SQ-D	
Allen Bradley	Series 509	J	F-225	K	B7025A2
Allen Bradley	Series 509	K	J-600	L	B7025A4
Cutler Hammer	Freedom-AN16	J	F-225	K	B7025C2
Cutler Hammer	Freedom-AN16	K	J-600	L	B7025C4
General Electric	Series 306	J	F-225	K	B7025G2
General Electric	Series 306	K	J-600	L	B7025G4
Square D	Series 8536	J	F-225	K	B7025S2
Square D	Series 8536	K	J-600	L	B7025S4
Westinghouse	Advantage	J	F-225	K	B7025W2
Westinghouse	Advantage	K	J-600	L	B7025W4





Supplied with Cutler-Hammer Advantage Starters

Applications

The PRISM® B7 Series of Combination Starters are used for Motor Control and Circuit protection of motors in Hazardous And Hostile locations. These Hazardous locations are typically due to the presence of flammable gases or vapors, combustible dust, or easily ignitable fibers and flyings, and areas which are subject to corrosion, weather and dampness.

Advantage Starter Features

- Solid-State Electronic Starter
- Brownout Protection
- Communications capabilities
- Overload Heaters not required
- Phase loss and phase unbalance protection
- Selectable automatic/manual reset
- Class II ground-fault protection

Enclosure Features

- Nema 4, 4X rated – providing protection from hose directed water and corrosion
- Universal mounting pan, pre-drilled to facilitate easy field installation of starters. Provision for grounding supplied as standard.
- More wiring room – meets latest NEC wire bend requirements
- Quick release, captivated cover bolts of 316 grade stainless steel

- Flange sealing gasket located to the inside of cover bolt – preventing water seepage into enclosure through bolt holes
- Hinged cover provided as standard for an extra measure of safety and convenience
- Breaker (MCP) handle can be pad-locked in “ON” or “OFF” position
- Provisions provided for drain and breather plus conduit openings for power and control
- Field replaceable reset button provided as standard with gold contact blocks
- Two control operator openings provided plugged as standard. Additional openings can be factory or field drilled
- Copper-free (less than 4/10 of 1% copper) enclosure
- Ductile mounting lugs

Modifications & Accessories

- Select from B7 Modification Chart on page C48
- Minimum Control Transformer
 - Size 1-2 100VA
 - Size 3-4 150VA
 - Size 5 300VA
- Advantage Starters Auxiliary Contact Modules
 - 2NO/2NC = **B7ADAC**

Class I, Div. 1 & 2, Groups B,C,D
Class I, Zones 1 & 2, Groups IIB, IIA
Class II, Div. 1 & 2, Groups E,F,G
Class III, Div. 1 & 2
NEMA 3, 4, 4X, 7(B,C,D) 9(E,F,G)

Classified - File E83969

Certified - File LR11714
 See files for details or call Killark.

Standard Materials

Enclosure – Copper-free aluminum
 O-ring Gasket – BUNA-N nitrile
 Cover Bolts – 316 grade stainless steel
 CB/MCP Handle – Copper-free aluminum
 Reset Operator – Thermoplastic polyester button molded onto stainless steel shaft. Aluminum shroud.
 Mounting Pan – Sheet aluminum
 Hinge – Aluminum with stainless steel pin
 Reset Shroud – Black anodized

B7AD COMBINATION STARTER								
NEMA STARTER SIZE	MOTOR VOLTS	MAXIMUM HP	COIL VOLTS	FULL LOAD AMPERAGE RANGE(1)	DISCONNECT AMP TRIP	CATALOG NUMBER		
						WITH MOTOR PROTECTOR AND STARTER	ENCLOSURE ONLY	
1L	230	1	120/60	.47-4.14	3	B7AD02LH6CA	B7AD021	
	460	2				B7AD02LH6CB		
	575	2				B7AD02LH6CC		
1	230	7-1/2	120/60	3.15-27	30	B7AD021H6CF	B7AD021	
	460	10						
	575	10						
2	230	15	120/60	3.15-45	50	B7AD022H6CK	B7AD022	
	460	25						
	575	25						
3	230	30	120/60	9.9-90	100	B7AD023H6CQ	B7AD023	
	460	50						
	575	50						
4	230	50	120/60	9.9-133	150	B7AD024H6CT	B7AD024	
	460	100						
	575	100						
5	230	100	120/60	38.3-270	400	B7AD025H6K400	B7AD025K	
	460	200						
	575	200						

Notes: (1) Heaters are not required with the Advantage Starter. The Overload Module has trip current settings via DIP Switch between the amperage range shown.

(2) All Advantage Starters are wired for separate control and must be controlled at the coil voltage shown. For 50 HZ applications a 110V 50 Hz coil is available. To order with this 50 Hz coil replace the number “6” in catalog number with “5”.

(3) Enclosures provide sufficient space for factory or field mounting a control transformer.



KILLARK®

B7 DIMENSIONS															
CATALOG NUMBER	NEMA SIZE	TYPE	DIMENSIONS									EST. ENCLCSRE WEIGH LBS.	CONDUIT OPENINGS TOP/BOTTOM (IN.) [Ⓢ]		
			A	B	C	D	E	F	G	H	I		POWER	CONTROL	DRAIN BREATHER
B7011	0,1	Starter Only	18" (457)	11" (280)	9-1/8" (232)	3-5/8" (92)	16-3/8" (416)	2-1/8" (54)	2-3/8" (60)	2-11/16" (68)	3-7/16" (87)	46	1-1/2"	3/4"	1/2"
B7012	2	Starter Only	20" (508)	12-1/2" (317)	9-1/8" (232)	5" (127)	18-3/8" (467)	2-1/2" (63)	2-1/2" (63)	2-11/16" (68)	3-3/16" (81)	56	1-1/2"	3/4"	1/2"
B7013	3	Starter Only	26-1/4" (667)	12-1/2" (317)	10-3/4" (276)	5" (127)	24-5/8" (625)	2-1/2" (63)	2-3/4" (70)	4-1/16" (103)	5-1/2" (140)	80	2"	1"	1/2"
B7014	4	Starter Only	34-1/4" (870)	16-1/2" (419)	11-1/2" (292)	9" (229)	32-5/8" (830)	3-3/4" (95)	4" (102)	4-7/16" (113)	6" (152)	155	3"	1"	1/2"
B7021	0,1	Combination Starter	23" (584)	14-1/2" (368)	9-1/8" (232)	7" (178)	21-3/8" (543)	2-1/8" (54)	2-1/2" (64)	2-11/16" (68)	3-7/16" (87)	78	1-1/2"	3/4"	1/2"
B7022	2	Combination Starter	25-1/2" (648)	14-1/2" (368)	9-1/8" (232)	7" (178)	23-7/8" (606)	2-1/8" (54)	2-1/2" (64)	2-11/16" (68)	3-7/16" (87)	88	1-1/2"	3/4"	1/2"
B7023	3	Combination Starter	27-1/4" (692)	17-7/8" (454)	11" (280)	10-3/8" (263)	25-5/8" (651)	3-1/2" (89)	3-1/2" (89)	4-3/16" (106)	5-1/2" (140)	143	2"	1"	1/2"
B7024	4	Combination Starter	34-1/4" (870)	21-1/2" (546)	11-7/8" (302)	14" (356)	32-5/8" (829)	4-3/4" (121)	5" (127)	4-9/16" (116)	6-3/16" (157)	235	3"	1"	1/2"

Ⓢ 1/2" conduit openings may be used for drain and/or breather installation. Smaller conduit openings may be used by utilizing reducing bushings.
Custom conduit sizes and locations are available upon request.

DIMENSIONS FOR SIZE 5 COMBINATION STARTER													
DIMENSIONS										CONDUIT TOP & BTM. (NPT)			ENCL. WT. (LBS.)
A	B	C	D	E	F	G	H	I	J	K	L	M	
62-1/4" (1581)	20-1/4" (514)	15" (381)	18-1/2" (470)	43-1/2" (1105)	2-5/8" (67)	3-1/8" (79)	5-3/8" (137)	7-3/8" (187)	3-1/2 (89)	4" (102)	1/2" (13)	1" (25)	540

Dimensions B7 Size 0 Thru 4

Dimensions B7 Size 5

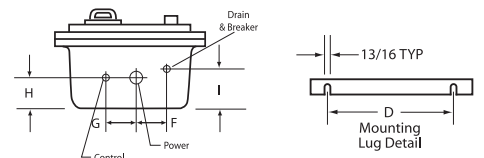
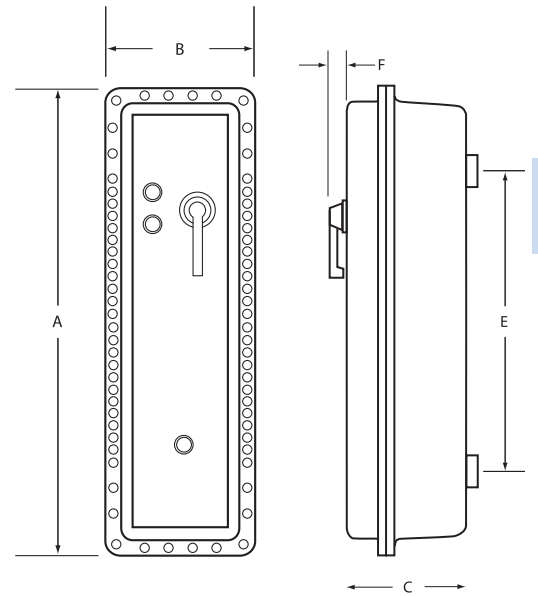
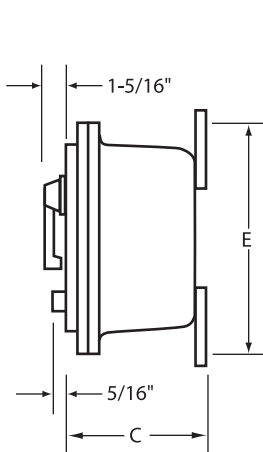
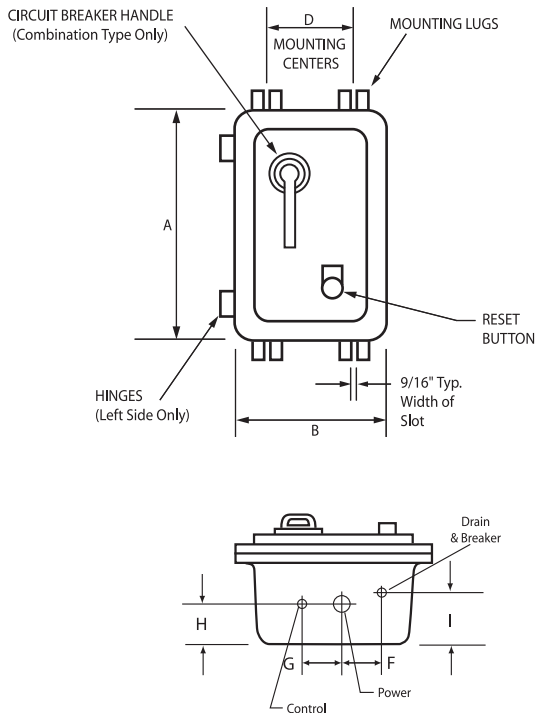

B7 MODIFICATIONS AND ACCESSORIES		
CATALOG NUMBER		DESCRIPTION
SIZE 0 THRU 4	SIZE 5	
B7DBP	B7EDBP	Double pushbutton (Start/Stop)
B7RPL	B7ERPL	Red pilot light 120 Volt
B7GPL	B7EGPL	Green pilot light 120 Volt
B7APL	B7EAPL	Amber pilot light 120 Volt
B7LPBR	B7ELPBR	Illuminated red pushbutton 120 Volt
B7LPBG	B7ELPBG	Illuminated green pushbutton 120 Volt
B7LPBA	B7ELPBA	Illuminated amber pushbutton 120 Volt
B7PLR220	B7PLR220	Pilot light resistor 220 Volt to 110 Volt
B7PLR440	B7PLR440	Pilot light resistor 440 Volt to 110 Volt
B7PLR550	B7PLR550	Pilot light resistor 550 Volt to 110 Volt
B72SS	B7ESS	2 position selector switch (On-Off)
B7SSHOA	B7ESSHOA	3 position selector switch (Hand-Off-Auto)
B7HAC	B75CAC	Cutler Hammer auxiliary contact (1N0/1NC)
B7SAC	B75SAC	Square D auxiliary contact (1N0/1NC)
B7TB	B7TB	Terminal block (6 Terminals)
—	B7IPR	Interposing relay 120 Volt coil
B7CT50	—	Control transformer 50VA (0,1,2)*
B7CT75	—	Control transformer 75VA (0,1,2)*

B7 MODIFICATIONS AND ACCESSORIES (CONTINUED)		
CATALOG NUMBER		DESCRIPTION
SIZE 0 THRU 4	SIZE 5	
B7CT100	—	Control transformer 100VA (0,1,2)*
B7CT150	—	Control transformer 150VA (0,1,2)*
B7CT200	—	Control transformer 200VA (3,4)*
B7CT250	—	Control transformer 250VA (3,4)*
—	B7CT300	Control transformer 300VA (5)*
—	B7CT500	Control transformer 500VA (5)*
KB1B	KB1B	Breather** (not CSA)
KB1D	KB1D	Drain** (not CSA)
KIT-251	KIT-251	Grounding kit
B7SF	B7SF	Special finish - Baked epoxy outside
B7DLO	B7DLO	Delete lock ""ON"" feature for breaker handle
B7SH251	B7SH251	Space heater 25 Watt 120 Volt
B7SH252	B7SH252	Space heater 25 Watt 240 Volt
B7SH254	B7SH254	Space heater 25 Watt 480 Volt
B7SH501	B7SH501	Space heater 50 Watt 120 Volt
B7SH502	B7SH502	Space heater 50 Watt 240 Volt
B7SH504	B7SH504	Space heater 50 Watt 480 Volt

* Control transformers are primary 240/480 - Secondary 120 Volt. **Control transformers for use on Combination Starters Only. Will not fit into B701 Series of Non-Combination Starters.**

* All control transformers include fused primary and secondary circuits.

** Installation of drains and breathers will void the NEMA4-4x ratings - voids Group B for CSA.

Catalog Logic - B7 Enclosures with Controls

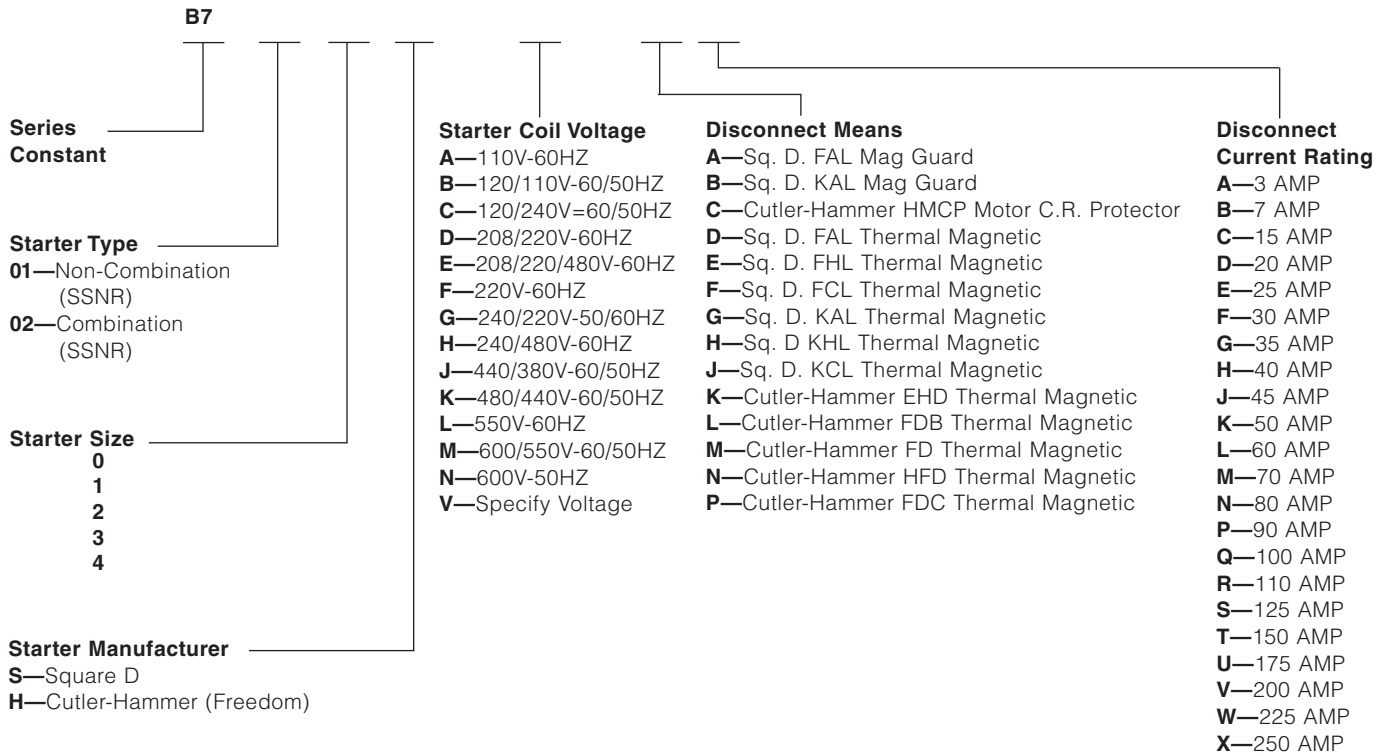

This Catalog Logic Chart is for reference only and is to be used for selection of special voltage and amperage requirements. Consult Factory since not all assemblies are available with complete list of options displayed.

Overload heaters are not supplied as part of the starter assemblies and are to be ordered as separate items by catalog number and priced accordingly. Heaters should be selected on the basis of the actual full-load current and service factor as shown on the

motor nameplate or in the manufacturer's published literature. When motor and overload relay are in the same ambient and the service factor of the motor is 1.15 to 1.25, select heaters from the heater selection chart. If the service factor of the

motor is 1.0, or there is no service factor shown, or a maximum of 115% protection is desired, select one size smaller heater than indicated.

When motor and overload relay are in different ambients, select heaters from the chart using adjusted motor

currents as follows: decrease rated motor current 1% for each PC motor ambient exceeds controller ambient; increase rated motor current 1% for each PC controller ambient exceeds motor ambient.

SQUARE D 8536 SERIES STARTERS SSNR NEMA SIZES 0-1 THROUGH 5															
CATALOG NUMBER		FULL-LOAD CURRENT (AMPS)		CATALOG NUMBER		FULL-LOAD CURRENT (AMPS)		CATALOG NUMBER		FULL-LOAD CURRENT (AMPS)					
FOR SIZE 0-1				FOR SIZE 1				FOR SIZE 3				FOR SIZE 4			
KB044		0.28-0.30		KB022		11.4-12.7		KCC209		13.6-14.5		KCC643		41.1-43.5	
KB051		0.31-0.34		KB025		12.8-14.1		KCC228		14.6-15.5		KCC685		43.6-46.8	
KB057		0.35-0.37		KB280		14.2-15.9		KCC246		15.6-17.4		KCC746		46.9-50.0	
KB063		0.38-0.44		KB032		16.0-17.5		KCC263		17.5-18.5		KCC815		50.1-54.9	
KB071		0.45-0.53		KB036		17.6-19.7		KCC288		18.6-19.9		KCC877		55.0-57.5	
KB081		0.54-0.59		KB040		19.8-21.9		KCC310		20.0-21.5		KCC940		57.6-61.8	
KB092		0.60-0.64		KB045		22.0-24.4		KCC333		21.6-22.9		KCC103		61.9-66.2	
KB103		0.65-0.72		KB050		24.5-26.0		KCC364		23.0-24.5		KCC112		66.3-72.4	
KB116		0.73-0.80		FOR SIZE 2				KCC396		24.6-26.3		KCC121		72.5-78.1	
KB130		0.81-0.90		KB485		3.18-3.40		KCC427		26.4-28.2		KCC132		78.2-80.7	
KB145		0.91-1.03		KB550		3.41-3.76		KCC466		28.3-30.0		KCC143		80.8-86.5	
KB167		1.04-1.14		KB625		3.77-4.00		KCC501		30.1-32.3		KCC156		86.6-93.9	
KB188		1.15-1.27		KB690		4.01-4.57		KCC545		32.4-34.9		KCC167		94.0-100	
KB210		1.28-1.43		KB770		4.58-5.03		KCC594		35.0-37.6		KCC180		101.-112.	
KB240		1.44-1.62		KB820		5.04-5.32		KCC643		37.7-40.0		KCC196		113.-117.	
KB265		1.63-1.77		KB910		5.33-5.97		KCC685		40.1-42.8		KCC208		118.-123.	
KB330		1.78-1.97		KB102		5.98-6.88		KCC749		42.9-45.3		KCC219		124.-133.	
KB300		1.98-2.32		KB115		6.89-7.82		KCC815		45.4-49.1		FOR SIZE 5			
KB370		2.33-2.51		KB128		7.83-8.47		KCC877		49.2-53.4		KDD112		82.5-88.2	
KB415		2.52-2.99		KB014		8.48-9.15		KCC940		53.5-57.4		KDD121		88.3-95.9	
KB485		3.00-3.42		KB155		9.16-10.1		KCC103		57.5-61.3		KDD128		96.0-102.	
KB550		3.43-3.75		KB175		10.2-11.2		KCC112		61.4-63.5		KDD140		103.-109.	
KB625		3.76-3.98		KB195		11.3-12.0		KCC121		63.6-66.3		KDD150		110.-121.	
KB690		3.99-4.48		KB022		12.1-13.6		KCC132		66.4-69.0		KDD160		122.-139.	
KB770		4.49-4.93		KB025		13.7-15.2		KCC143		69.1-70.9		KDD185		140.-154.	
KB820		4.94-5.21		KB280		15.3-17.1		KCC156		71.0-73.7		KDD220		155.-163.	
KB910		5.22-5.84		KB032		17.2-19.0		KCC167		73.8-76.5		KDD240		164.-175.	
KB102		5.85-6.67		KB036		19.1-21.5		KCC180		76.6-78.4		KDD250		176.-184.	
KB115		6.68-7.54		KB040		21.6-24.1		KCC196		78.5-86.0		KDD265		185.-195.	
KB128		7.55-8.14		KB045		24.2-27.0						KDD280		196.-215.	
KB014		8.15-8.72		KB050		27.1-28.7						KDD300		216.-224.	
KB155		8.73-9.66		KB056		28.8-30.4						KDD320		225.-243.	
KB175		9.67-10.5		KB062		30.5-32.2						KDD320		244.-266.	
KB195		10.6-11.3		KB070		32.3-35.4									
KB022		11.4-12.0		KB079		35.5-38.2									
				KB088		38.3-45.0									

NOTE: Square D 8536 series starters SSNR ambient compensated 20PC to 60PC block type overload using 3 heaters. Three required for each starter.

CUTLER-HAMMER HEATER (EACH HEATER PACK CONSISTS OF 3 HEATERS)													
CATALOG NUMBER	MOTOR FULL-LOAD AMPERE RATING DIAL POSITION				CATALOG NUMBER	MOTOR FULL-LOAD AMPERE RATING DIAL POSITION							
	A	B	C	D		A	B	C	D				
FOR SIZES 0-1													
KH2001B-3	.254	.306	.359	.411	FOR SIZE 2								
KH2002B-3	.375	.452	.530	.607	KH2015B-3	29.0	34.0	39.1	44.1				
KH2003B-3	.560	.676	.791	.907	KH2016B-3	39.6	45.5	51.5	57.4				
KH2004B-3	.814	.983	1.15	1.32	KH2017B-3	53.9	60.9	67.9	74.9				
KH2005B-3	1.20	1.45	1.71	1.96	FOR SIZES 3-4								
KH2006B-3	1.79	2.16	2.53	2.90	KH2018-3	18.0	20.2	22.3	24.5				
KH2007B-3	2.15	2.60	3.04	3.49	KH2019-3	24.6	27.6	30.5	33.4				
KH2008B-3	3.23	3.90	4.56	5.23	KH2020-3	33.5	37.5	41.5	45.6				
KH2009B-3	4.55	5.50	6.45	7.40	KH2021-3	45.7	51.2	56.7	62.1				
KH2010B-3	6.75	8.17	9.58	11.0	KH2022-3	62.2	69.7	77.1	84.6				
KH2011B-3	9.14	10.8	12.4	14.0	KH2023-3	84.7	95.0	105.0	115.0				
KH2012B-3	14.0	16.9	19.9	22.8	KH2024-3	106.0	118.0	131.0	144.0				
KH2013B-3	18.7	22.7	26.7	30.7	FOR SIZE 5								
KH2014B-3	23.5	28.5	33.5	38.5	KH2004B-3	49	59	69	79				
					KH2005B-3	72	87	103	118				
					KH2006B-3	107	130	152	174				
					KH2007B-3	129	156	182	209				
					KH2008B-3	194	234	274	---				



Y7011ZH

Class I, Div. 1 & 2, Groups C,D
Class 1, Zones 1 & 2, Groups IIB, IIA
Class II, Div. 1 & 2, Groups E,F,G
Class III
NEMA 7(C,D) 9(E,F,G)

 Certified - File LR11714

 APPROVED Contact Killark for FM file numbers.
See files for details or call Killark.

FEATURES-SPECIFICATIONS

Applications

- Hazardous areas due to the presence of flammable gases or vapors, combustible dusts or easily ignitable fibers or flyings
- Installations at petroleum refineries, chemical and petrochemical plants, storage areas and other processing facilities where hazardous substances are handled or stored
- Full-voltage, across-the-line starting and stopping of polyphase AC squirrel cage induction motors or as the primary starter for wound rotor motors
- Provides running and undervoltage protection of motor
- Remote starting and stopping of motor

Features

- Rectangular bolted cover design provides for attractive, compact, uniform installations
- Ground flange joint between box and cover provides required flame path
- Two drilled and tapped power conduit openings, one top and one bottom are standard on all assemblies.
- One 3/4"-14 NPT drilled, tapped and plugged conduit opening is provided in bottom for remote control
- Two 3/4"-14 NPSM drilled, tapped, and plugged openings in cover are provided for addition of local control operator

- External reset button and stainless steel cover bolts are standard
- Hinges are either stainless steel or aluminum and are mounted on the left side of all assemblies
- Enclosure is cast copper-free aluminum alloy
- Available for Cutler-Hammer AN16 Freedom or Square D 8536 starters

Overload Heaters

Heaters not included. See page C49 for heater selection

Dimensions

See page C52 for dimensional data

Modifications

See page C52

Y7 MAGNETIC LINE STARTER (ENCLOSURES WITHOUT SPACE FOR CONTROL TRANSFORMER)					
NEMA STARTER SIZE	MOTOR VOLTS	COIL VOLTS	MAXIMUM HP	CATALOG NUMBER	
				CUTLER-HAMMER SERIES AN16	SQUARE D SERIES 8536
0	Sep Control	120	—	Y7010BH	Y7010BS
0	230	240	3	Y7010DH	Y7010DS
0	440-460	480	5	Y7010KH	Y7010KS
1	Sep Control	120	—	Y7011BH	Y7011BS
1	230	240	7-1/2	Y7011DH	Y7011DS
1	440-460	480	10	Y7011KH	Y7011KS
2	Sep Control	120	—	Y7012BH	Y7012BS
2	230	240	15	Y7012DH	Y7012DS
2	440-460	480	25	Y7012KH	Y7012KS
0	Enclosure only No interior			Y7010ZH	Y7010ZS
1	Enclosure only No interior			Y7011ZH	Y7011ZS
2	Enclosure only No interior			Y7012ZH	Y7012ZS

Y7 MAGNETIC LINE STARTER (ENCLOSURES WITH SPACE FOR CONTROL TRANSFORMER)					
NEMA STARTER SIZE	MOTOR VOLTS	COIL VOLTS	MAXIMUM HP	CATALOG NUMBER	
				CUTLER-HAMMER SERIES AN16	SQUARE D SERIES 8536
0	230//460	120	3//5	Y7000BH	Y7000BS
1	230//460	120	7 1/2//10	Y7001BH	Y7001BS
2	230//460	120	15//25	Y7002BH	Y7002BS
0	Enclosure only No interior			Y7000ZH	Y7000ZS
1	Enclosure only No interior			Y7001ZH	Y7001ZS
2	Enclosure only No interior			Y7002ZH	Y7002ZS



Y7021ZHAZ

Class I, Div. 1 & 2, Groups C,D
Class I, Zones 1 & 2, Groups IIB, IIA
Class II, Div. 1 & 2, Groups E,F,G
Class III
NEMA 7(C,D) 9(E,F,G)

 Certified - File LR11714

 APPROVED Contact Killark for FM file numbers.
See files for details or call Killark.

FEATURES-SPECIFICATIONS

Applications

- Hazardous areas due to the presence of flammable gases or vapors, combustible dusts or easily ignitable fibers or flyings
- Full-voltage, across-the-line starting and stopping of polyphase AC squirrel cage induction motors or as the primary starter for wound rotor motors
- Provides running and undervoltage protection of motor
- Motor branch circuit disconnect and short circuit protection

Features

- Rectangular bolted cover design provides for attractive, compact, uniform installations
- Two 3/4"-14 NPSM drilled, tapped, and plugged openings are provided for addition of local operators
- Two drilled, tapped and plugged openings, one top and one bottom are supplied for installation of drain and breather
- Hinges are either stainless steel or aluminum and are mounted on the left side of all assemblies
- Circuit breaker handle mechanism interlocks with circuit breaker to prevent opening of enclosure when circuit is in the "ON" position

- External handle is vault type with standard provisions for locking in the "OFF" position with up to three padlocks
- Circuit breaker is trip free of handle mechanism

Modifications

Modifications are available.
See page C52.

Dimensions

For dimensional data, see page C52.

Overload Heaters

Heaters are not included.
See page C49 for heater selection.

Y7 COMBINATION MAGNETIC LINE STARTER						
NEMA STARTER SIZE	MOTOR VOLTS	COIL VOLTS	MAXIMUM HP	DISCONNECT TRIP AMPS	CATALOG NUMBER	
					CUTLER-HAMMER SERIES AN16	SQUARE D SERIES 8536
0	Sep Control	120	-	3	Y7020BHV	Y7020BSV
0	Sep Control	120	-	7	Y7020BH	Y7020BSV
0	Sep Control	120	-	15	Y7020BHVA	Y7020BSVA
0	230	240	1	7	Y7020DHV	Y7020DSV
0	230	240	3	15	Y7020DHVA	Y7020DSVA
0	460	480	1	3	Y7020KHV	Y7020KSV
0	460	480	5	7	Y7020KHV	Y7020KSV
1	Sep Control	120	-	15	Y7021BHVA	Y7021BSVA
1	Sep Control	120	-	30	Y7021BHVC	Y7021BSVC
1	230	240	7-1/2	30	Y7021DHVC	Y7021DSVC
1	460	480	10	30	Y7021KHVC	Y7021KSVC
2	Sep Control	120	-	50	Y7022BHVE	Y7022BSVE
2	Sep Control	120	-	70	Y7022BHVG	Y7022BSVG
2	230	240	15	50	Y7022DHVE	Y7022DSVE
2	230	240	15	70	Y7022DHVG	Y7022DSVG
2	460	480	25	50	Y7022KHVE	Y7022KSVE
0	Enclosure only. No Interior				Y7020ZHVZ	Y7020ZSVZ
1	Enclosure only. No Interior				Y7021ZHVZ	Y7021ZSVZ
2	Enclosure only. No Interior				Y7022ZHVZ	Y7022ZSVZ

Combination Starter Modifications

Modifications are available by ordering the following by catalog number as separate items and noting on the order that they are to be assembled into the enclosure.

FEATURES-SPECIFICATIONS

Y7 MAGNETIC LINE STARTERS DIMENSIONS										
NEMA SIZE	A	B	D	E	G	H	J	K	CONDUIT SIZE	
									POWER	CONTROL
0-1 [Ⓧ]	7-3/4"(197)	7-1/4"(184)	10"(254)	6"(152)	2"(51)	7-5/8"(194)	1-1/8"(28)	3/4"(19)	1-1/2"	3/4"
2 [Ⓧ]	9"(228)	7-3/4"(197)	11-1/4"(286)	6-1/2"(165)	2"(51)	7-5/8"(194)	1-1/8"(28)	7/8"(22)	1-1/2"	3/4"
0-1 [Ⓞ]	8-3/4"(222)	11-1/8"(282)	12-1/2"(317)	10-1/2"(267)	2"(51)	8-1/4"(209)	2-3/8"(60)	2-3/8"(60)	1-1/2"	3/4"
2 [Ⓞ]	8-3/4"(222)	11-1/8"(282)	12-1/2"(317)	10-1/2"(267)	2"(51)	8-1/4"(209)	2-3/8"(60)	2-3/8"(60)	1-1/2"	3/4"

[Ⓧ] Without space for control transformer. [Ⓞ] With space for control transformer.

Y7 COMBINATION STARTERS DIMENSIONS										
NEMA SIZE	A	B	D	E	G	H	J	CONDUIT SIZE		
								POWER	CONTROL	
0-1	16-1/4"(413)	11-1/8"(282)	20"(508)	10-1/2"(267)	2"(51)	9"(228)	2-3/8"(60)	1-1/2"	3/4"	
2	16-1/4"(413)	11-1/8"(282)	20"(508)	10-1/2"(267)	2"(51)	9"(228)	2-3/8"(60)	1-1/2"	3/4"	

Dimensions

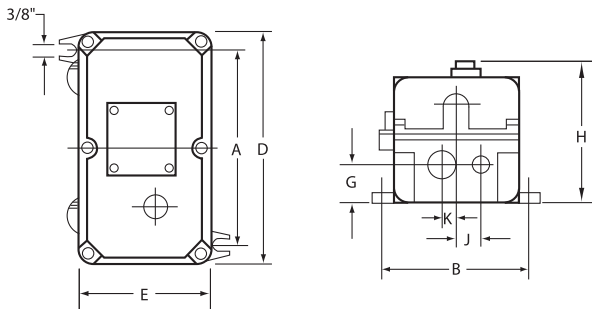

Magnetic Line Starters
Sizes 0, 1, 2

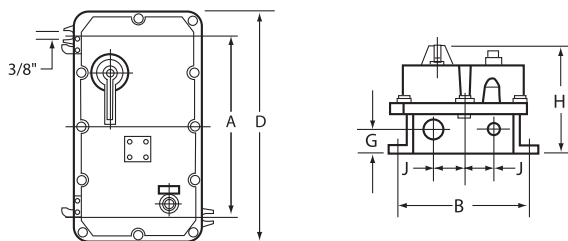

Combination Starters
Sizes 0, 1, 2

Y7 MODIFICATIONS AND ACCESSORIES	
CATALOG NUMBER	DESCRIPTION
G022-GR12D	Double pushbutton (Start/Stop)
GOB3-R23C N34	Red pilot light 120 Volt
GOB3-G23C N34	Green pilot light 120 Volt
GOB3-A23C N34	Amber pilot light 120 Volt
B7PLR220	Pilot light resistor 220 Volt to 120 Volt
B7PLR440	Pilot light resistor 440 Volt to 120 Volt
B7PLR550	Pilot light resistor 550 Volt to 120 Volt
G025-2A3F	2 position selector switch (On/Off)
G025-3C3G	3 position selector switch (Hand/Off/Auto)
B7HAC	Cutler-Hammer auxiliary contact (1NO/1NC)
B7SAC	Square D auxiliary contact (1NO/1NC)
B7CT50	Control transformer 50VA*
B7CT75	Control transformer 75VA*
B7CT100	Control transformer 100VA*
KDB-1	Breather
KDB-1	Drain
KIT-251	Grounding kit

* Control transformers are primary 240/480 - Secondary 120 Volt.

* All control transformers include fused primary and secondary circuits.





**XSD, XSX, Series
Non Factory Sealed**



**FXSD, FXSX Series
Factory Sealed**

**Class I, Div. 1 & 2, Groups C,D
Class 1, Zones 1 & 2, Groups IIB, IIA
Class II, Div. 1 & 2, Groups E,F,G
Class III
NEMA 7(C,D) 9(E,F,G)
NEMA 3 (Factory sealed type)**

Listed - File E53360 and/or E12379

Certified - File LR11714

FM - File 25219
See files for details or call Killark.

FEATURES-SPECIFICATIONS

Applications

- Provides manual starting and stopping of small AC or DC motors
- Motor running protection when overload heaters are used
- XSX/FXSX Series (without overload protection) are ideally suited for across-the-line applications where a positive disconnect means is required

Features

- FXSX-FXSD Series require no external seals (factory sealed) and are NEMA 3 (raintight) rated
- Enclosures are cast copper-free aluminum alloy
- Operating shaft is stainless steel
- Multiple gang assemblies available in combination with pilot lights, push-buttons and switches on request
- Ground flange joint between bolted cover and box provide required flame path
- Provisions for padlocking switch in either "ON" or "OFF" position is standard

Dimensions

For dimensional data, see page C54.

XSD/FXSD SERIES WITH OVERLOAD PROTECTION ①

Non-Factory Sealed:

Square D, Class 2510, Type F
1-Pole, 1HP, 115-230 VAC
2-Pole, 1HP, 115-230 VAC
3/4 HP, 115-230 VDC

Factory Sealed:

Square D, Class 2510, Type F
1-Pole, 1HP, 115-230 VAC
2-Pole, 1HP, 115-230 VAC
3/4 HP, 115-230 VDC

XSD SINGLE GANG ②			
CATALOG NUMBER		HUB STYLE	HUB SIZE
1-POLE SINGLE PHASE	2-POLE SINGLE PHASE		
XSD-11	XSD-12	Dead end	1/2"
XSD-21	XSD-22		3/4"
XSD-41	XSD-42	Feed thru	1/2"
XSD-51	XSD-52		3/4"
XSD-01	XSD-02	Cover and Switch assembly	

FXSD SINGLE GANG			
CATALOG NUMBER		HUB STYLE	HUB SIZE
1-POLE SINGLE PHASE	2-POLE SINGLE PHASE		
FXSD11	FXSD12	Dead end	1/2"
FXSD21	FXSD22		3/4"
FXSD41	FXSD42	Feed thru	1/2"
FXSD51	FXSD52		3/4"
FXSD01	FXSD02	Cover and Switch assembly	

① Order heaters separately on page C54.
② FM and CSA only

XSX/FXSX SERIES WITHOUT OVERLOAD PROTECTION

Non-Factory Sealed:

Square D, Class 2510, Type K
2-Pole, 2 HP, 115 VAC
2 HP, 200-230 VAC
3 HP, 460-575 VAC
3-Pole, 2 HP, 115 VAC
7-1/2 HP, 200-230 VAC
10 HP, 460-575 VAC

Factory Sealed:

Square D, Class 2510, Type K
2-Pole, 2 HP, 115 VAC
2 HP, 200-230 VAC
3 HP, 460-575 VAC
3-Pole, 2 HP, 115 VAC
3 HP, 200-230 VAC
5 HP, 460-575 VAC

XSX SINGLE GANG ①			
CATALOG NUMBER		HUB STYLE	HUB SIZE
2-POLE 30A., 250V 20A., 600V 1-PHASE	3-POLE 30A., 250V 20A., 600V 3-PHASE		
XSX-12	XSX-13	Dead end	1/2"
XSX-22	XSX-23		3/4"
XSX-42	XSX-43	Feed thru	1/2"
XSX-52	XSX-53		3/4"
XSX-2	XSX-3	Cover and Switch assembly	

FXSX SINGLE GANG			
CATALOG NUMBER		HUB STYLE	HUB SIZE
2-POLE 30A., 250V 20A., 600V 1-PHASE	3-POLE 30A., 250V 20A., 600V 3-PHASE		
FXSX12	FXSX13	Dead end	1/2"
FXSX22	FXSX23		3/4"
FXSX42	FXSX43	Feed thru	1/2"
FXSX52	FXSX53		3/4"
FXSX02	FXSX03	Cover and Switch assembly	

① FM and CSA only



HEATER TABLE [Ⓞ]		
CATALOG NUMBER	FULL-LOAD MOTOR CURRENT	SQUARE D HEATER CATALOG NUMBER
YOSD-A.49	0.41-0.44	A.49
YOSD-A.54	0.45-0.49	A.54
YOSD-A.59	0.50-0.53	A.59
YOSD-A.65	0.54-0.58	A.65
YOSD-A.71	0.59-0.65	A.71
YOSD-A.78	0.66-0.71	A.78
YOSD-A.86	0.72-0.78	A.86
YOSD-A.95	0.79-0.85	A.95
YOSD-A1.02	0.86-0.96	A1.02
YOSD-A1.16	0.97-1.04	A1.16
YOSD-A1.25	1.05-1.16	A1.25
YOSD-A1.39	1.17-1.29	A1.39
YOSD-A1.54	1.30-1.37	A1.54
YOSD-A1.63	1.38-1.47	A1.63
YOSD-A1.75	1.48-1.56	A1.75
YOSD-A1.86	1.57-1.65	A1.86
YOSD-A1.99	1.66-1.79	A1.99
YOSD-A2.15	1.80-1.95	A2.15
YOSD-A2.31	1.96-2.15	A2.31
YOSD-A2.57	2.16-2.38	A2.57
YOSD-A2.81	2.39-2.75	A2.81
YOSD-A3.61	2.76-2.84	A3.61
YOSD-A3.95	2.85-3.06	A3.95
YOSD-A4.32	3.07-3.45	A4.32
YOSD-A4.79	3.46-3.70	A4.79
YOSD-A5.30	3.71-4.07	A5.30
YOSD-A5.78	4.08-4.32	A5.78
YOSD-A6.20	4.33-4.90	A6.20
YOSD-A6.99	4.91-5.35	A6.99
YOSD-A7.65	5.36-5.85	A7.65
YOSD-A8.38	5.86-6.41	A8.38
YOSD-A9.25	6.42-6.79	A9.25
YOSD-A9.85	6.80-7.57	A9.85
YOSD-A11.0	7.58-8.15	A11.0
YOSD-A11.9	8.16-8.98	A11.9
YOSD-A13.2	8.99-9.67	A13.2
YOSD-A14.1	9.68-9.95	A14.1
YOSD-A14.8	9.96-10.8	A14.8
YOSD-A16.2	10.9-12.1	A16.2
YOSD-A17.9	12.2-13.1	A17.9
YOSD-A19.8	13.2-13.9	A19.8
YOSD-A21.3	14.0-15.0	A21.3
YOSD-A25.2	15.1-16.0	A25.2

[Ⓞ] Overload heaters are not supplied as part of the starter assemblies and need to be ordered as separate items by catalog number and priced accordingly.

FEATURES-SPECIFICATIONS

XSD/XSX NON-FACTORY SEALED DIMENSIONS					
BOX STYLE	HUB SIZE	A	B	D	G
Single gang dead-end	1/2"	5-1/4"(133)	2-1/4"(57)	—	11/16"(17)
	3/4"	5-1/4"(133)	2-1/4"(57)	—	11/16"(17)
	1"	5-3/8"(136)	2-3/8"(60)	—	7/8"(22)
Single gang feed-thru	1/2"	5-1/4"(133)	2-1/4"(57)	6"(152)	11/16"(17)
	3/4"	5-1/4"(133)	2-1/4"(57)	6"(152)	11/16"(17)
	1"	5-3/8"(136)	2-3/8"(60)	6"(152)	7/8"(22)

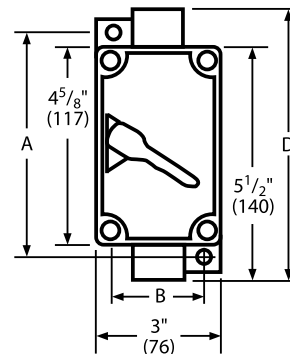
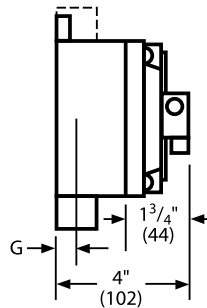

FACTORY SEALED (FXSD/FXSX)

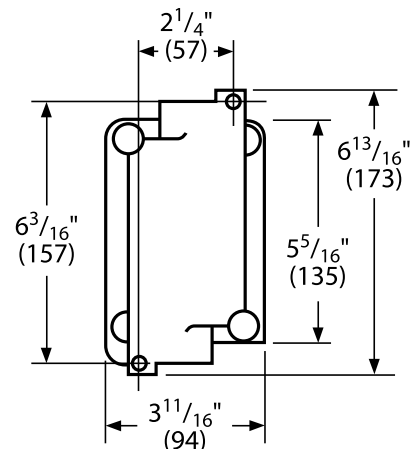
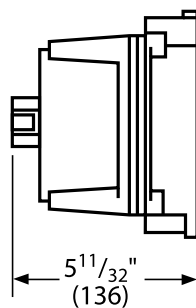



B7MS1P
 Push Button Style



B7MS2R
 Rotary Style

Class I, Div. 1 & 2, Groups B,C,D
Class I, Zones 1 & 2, Groups IIB+H2, IIA
Class II, Div. 1 & 2, Groups E,F,G
Class III, Div. 1 & 2
NEMA 3, 4, 4X, 7(B,C,D) 9(E,F,G)

US Certified - File LR11714

FEATURES-SPECIFICATIONS

Applications

The PRISM® B7MS Series of non-reversing, manual line voltage starters and enclosures are suitable for use in applications requiring manual across-the-line starting and stopping of small single and polyphase AC motors, and where overload protection is needed. Manual starters are generally used on small machine tools, fans and blowers, pumps, compressors, and conveyors as well as many other types of electrical equipment.

PRISM® enclosures universal design accommodates, as standard, IEC starter manufacturers including Square D, Cutler-Hammer, ABB, Siemens, Moeller, Sprecher + Schuh, Allen-Bradley, Advance Controls, and WEG.

Square D © Schneider Electric
 Siemens © Siemens AG
 Moeller © Moeller Electric Corp.
 See catalog pg. DE8A for copyrights of other brands referenced.

When ordered with starters, ABB or Square D supplied.

Features

- Compact size enclosures provide application flexibility with cost savings over industry standard sizes
- NEMA 4, 4X rated - providing protection from hose directed water and corrosion
- Pre-drilled to facilitate easy field installation of starters
- 2 operating styles, rotary or push button, including lock-out provision.
- Provisions for drain and breather
- Bi-directional ductile mounting lugs
- Two NPT conduit openings provided as standard, with custom openings on request

Electrical Rating

- Starters rated 600V, 3 phase up to 50HP

Standard Materials/Finish

- Enclosures: Copper-free aluminum (less than 4/10 of 1% copper content)
- Cover Bolts: 316 Stainless Steel
- O-ring Gasket: Silicone
- Finish: Grey Powder Polyester painted exterior, electrostatically applied

MODIFICATIONS	
SUFFIX NUMBER	DESCRIPTION
KIT-251	100 amp ground lug
A	Auxiliary contacts 1 NO + 1 NC
SU-2	Hinge-9 Installed
SU3*	Drain & Breather installed (NEMA 7CD)
SU3B*	Drain & Breather installed (NEMA 7BCD)
B7SPNPT	Change Std. conduit size and location
SU9	Special paint finish
SU14	Fungus proofing of enclosures

*NOTE: The installation of a Drain & Breather will void the NEMA 4-4X rating of enclosure.

Catalog Logic

B7MS 1 R S 1 A

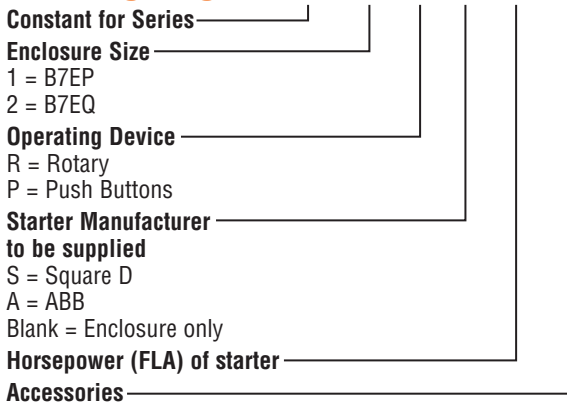

DIMENSIONS

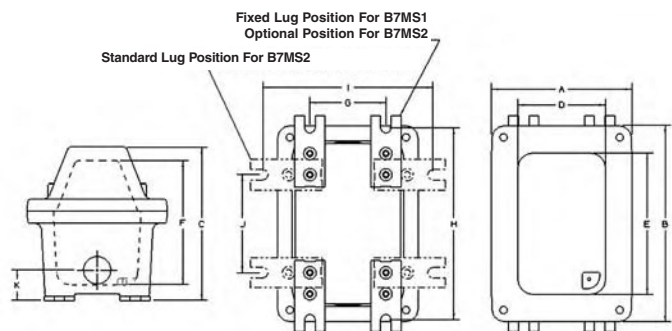

Enclosure	OUTSIDE BOX DIMENSIONS			NOMINAL INSIDE BOX			MOUNTING DIMENSIONS					CONDUIT SIZE
	A	B	C	D	E	F	G	H	I	J	K	
B7MS1	5-3/4	8-1/16	6-5/16	3-5/8	5-13/16	5-1/16	3-1/8	8-1/8	-	-	1-1/4	1
B7MS2	8-1/8	13-1/16	7-13/16	4-1/4	9-13/16	6-5/16	2-1/2	11-3/8	6-3/8	7-1/2	1-13/16	1-1/2



B7MS - ROTARY STYLE WITH ABB MS132 & MS450 SERIES								
	CATALOG NUMBER	ADJUSTMENT RANGE FLA	SINGLE PHASE HP		200V-208V	230V	THREE PHASE HP	
			120V	230V			480V	600V
ENCLOSURE WITHOUT STARTER B7MS1R	B7MS1RA-1	0.63 - 1.0					0.5	0.5
	B7MS1RA-2	1.0 - 1.6		0.1			0.75	0.75
	B7MS1RA-3	1.6 - 2.5		0.167		0.5	1	1.5
	B7MS1RA-4	2.5 - 4.0	0.125	0.33		1	2	3
	B7MS1RA-5	4.0 - 6.3	0.25	0.5		1.5	3	5
	B7MS1RA-6	6.3 - 9.0	0.33	1		2.5	5	7.5
	B7MS1RA-7	9.0 - 12.5	0.5	2		3	7.5	10
	B7MS1RA-8	12.5 - 16.0	1	2.5		5	10	10
	B7MS1RA-9	16.0 - 20.0	1.5	3		5	10	15
	B7MS1RA-10	20.0 - 25.0	2	3		7.5	15	20
ENCLOSURE WITHOUT STARTER B7MS2RA FOR USE WITH ABB ONLY	B7MS2RA-12	11 - 16	1	3	5	5	10	15
	B7MS2RA-13	14 - 20	1.5	3	5	7.5	15	20
	B7MS2RA-14	18 - 25	2	5	7.5	10	20	25
	B7MS2RA-15	22 - 32	3	5	10	10	25	30
	B7MS2RA-16	28 - 40	3	7.5	15	15	30	40
	B7MS2RA-17	36 - 45	5	7.5	15	15	30	40
	B7MS2RA-18	40 - 50	5	10	15	20	40	50

B7MS - PUSH BUTTON STYLE SQUARE D GV2 SERIES								
	CATALOG NUMBER	ADJUSTMENT RANGE FLA	SINGLE PHASE HP		200V-208V	230V	THREE PHASE HP	
			120V	230V			480V	600V
ENCLOSURE WITHOUT STARTER B7MS1P*	B7MS1PS-1	0.63 - 1.0					0.5	0.5
	B7MS1PS-2	1.0 - 1.6		0.1			0.75	1
	B7MS1PS-3	1.6 - 2.5		0.167	0.5	0.5	1	1.5
	B7MS1PS-4	2.5 - 4.0	0.125	0.33	0.75	1	2	3
	B7MS1PS-5	4.0 - 6.3	0.25	0.5	1.5	1.5	3	5
	B7MS1PS-6	6.0 - 10.0	0.5	1.5	2	3	5	7.5
	B7MS1PS-7	9.0 - 14.0	0.75	2	3	3	10	10
	B7MS1PS-8	13.0 - 18.0	1	3	5	5	10	15
	B7MS1PS-9	17.0 - 23.0	1.5	3	5	7.5	15	20
	B7MS1PS-10	20.0 - 25.0	2	3	5	7.5	15	20
ENCLOSURE WITHOUT STARTER B7MS2P	B7MS2PS-12	10.0 - 16.0	1	2	3	5	10	10
	B7MS2PS-14	16.0 - 25.0	2	3	5	7.5	15	20
	B7MS2PS-16	25.0 - 40.0	3	7.5	10	10	25	30
	B7MS2PS-18	40.0 - 63.0	5	10	20	20	40	50

B7MS - ROTARY STYLE WITH SQUARE D GV2 & GV3 SERIES								
	CATALOG NUMBER	ADJUSTMENT RANGE FLA	SINGLE PHASE HP		200V-208V	230V	THREE PHASE HP	
			120V	230V			480V	600V
ENCLOSURE WITHOUT STARTER B7MS1R	B7MS1RS-1	0.63 - 1.0					0.5	0.5
	B7MS1RS-2	1.0 - 1.6		0.1			0.75	1
	B7MS1RS-3	1.6 - 2.5		0.167	0.5	0.5	1	1.5
	B7MS1RS-4	2.5 - 4.0	0.125	0.33	0.75	1	2	3
	B7MS1RS-5	4.0 - 6.3	0.25	0.5	1.5	1.5	3	5
	B7MS1RS-6	6.0 - 10.0	0.5	1.5	2	3	5	7.5
	B7MS1RS-7	9.0 - 14.0	0.75	2	3	3	10	10
	B7MS1RS-8	13.0 - 18.0	1	3	5	5	10	15
	B7MS1RS-9	17.0 - 23.0	1.5	3	5	7.5	15	20
	B7MS1RS-10	20.0 - 25.0	2	3	5	7.5	15	20
	B7MS1RS-11	24.0 - 32.0	2	5	10	10	20	30
ENCLOSURE WITHOUT STARTER B7MS2R								

B7MS1R - For use with ABB MS116, MS325, MS132 Automation Direct BM3 Cutler-Hammer XTPR Moeller PKZMO Siemens 3RV Sprecher + Schuh KTA7 SQ D Telemecanique GV2P WEG MPW25

B7MS2R - For use with Automation Direct BM3
B7MS2RA - For use with ABB MS450
B7MS1P - For use with Cutler-Hammer XTPB Moeller PKZMO1 SQ D Telemecanique GV2ME WEG MPW25

B7MS2P - For use with Advance Control MMS25

* **B7MS1PRW** - (enclosure without starter) For use with Allen-Bradley 140 Sorecher + Schuh KT4





B7MSN2P



INTERNAL VIEW

Class I, Div. 1 & 2, Groups B,C,D
Class I, Zones 1 & 2, Groups IIB+H2, IIA
Class II, Div. 1 & 2, Groups E,F,G
Class III, Div. 1 & 2
NEMA 3, 4, 4X, 7(B,C,D) 9(E,F,G)

c US Certified - File LR11714

FEATURES-SPECIFICATIONS

Applications

The PRISM® B7MSN Series of non-reversing, manual line voltage starters and enclosures are suitable for use in applications requiring manual across-the-line starting and stopping of small single and polyphase AC motors, and where overload protection is needed. Manual starters are generally used on small machine tools, fans and blowers, pumps, compressors, and conveyors as well as many other types of electrical equipment.

PRISM® enclosures universal design accommodates, as standard, starter manufacturers including

- Allen-Bradley 609 Series
- Cutler-Hammer B100M Series
- GE CR106 Series
- Square D 2510M Series

Allen Bradley © Rockwell Automation
 Cutler-Hammer © Eaton Corporation
 GE © General Electric Company
 Square D © Schneider Electric

Features

- Compact size enclosures provide application flexibility with cost savings over industry standard sizes
- NEMA 4, 4X rated - providing protection from hose directed water and corrosion
- Pre-drilled to facilitate easy field installation of starters
- Large double green/red start-stop push buttons
- Can be pad locked in "OFF" position
- Provisions for drain and breather
- Bi-directional ductile mounting lugs
- Two 1-1/2" NPT conduit openings provided as standard, with custom openings on request

Electrical Rating

NEMA starter sizes 0, 1, 1-1/2 FVNR;
 2 pole single phase = 230 VAC
 3 pole three phase = 600 VAC
 2 pole VDC = 230 VDC

Overload Heaters

Heaters are not included, see next page.

Standard Materials /Finish

- Enclosures: Copper-free aluminum (less than 4/10 of 1% copper content)
- Cover Bolts: 316 Stainless Steel
- O-ring Gasket: Silicone
- Finish: Grey Powder Polyester painted exterior, electrostatically applied

MODIFICATIONS	
SUFFIX NUMBER	DESCRIPTION
KIT-251	100 amp ground lug
AO	Aux. contact NO only
AC	Aux. contact NC only
SU-2	Hinge-9 Installed
SU3*	Drain & Breather installed (NEMA 7CD)
SU3B*	Drain & Breather installed (NEMA 7BCD)
B7SPNPT	Change Std. conduit size and location
SU9	Special paint finish
SU14	Fungus proofing of enclosures

*NOTE: The installation of a Drain & Breather will void the NEMA 4-4X rating of enclosure.

ENCLOSURE	CATALOG NUMBER		SIZE/PHASE	SINGLE PHASE HP		THREE PHASE				DC HP	
	W/CUTLER-HAMMER	W/SQUARE D		120VAC	230VAC	208VAC	230VAC	480VAC**	600VAC	115DC	230VDC
B7MSN2P	B7MSN2PC0B	B7MSN2PS0B	M-0 2P	1	2					1 CH	1.5 CH
	B7MSN2PC1B	B7MSN2PS1B	M-1 2P	2	3					1.5 CH	2 CH
		B7MSN2PSDB	M-1P 2P	3	5						
	B7MSN2PC0C	B7MSN2PS0C	M-0 3P			3	3	5	5		
	B7MSN2PC1C	B7MSN2PS1C	M-1 3P			7.5	7.5	10	10		
		B7MSN2PS0V	M-0 2P VDC							1	1.5
	B7MSN2PS1V	M-1 2P VDC							1.5	2	

** = INCLUDES 380VAC CH = CUTLER-HAMMER ONLY

Enclosure	OUTSIDE BOX DIMENSIONS			NOMINAL INSIDE BOX			MOUNTING DIMENSIONS				
	A	B	C	D	E	F	G	H	I	J	K
B7MSN2P	8-1/8	13-1/16	7-13/16	4-1/4	9-13/16	6-5/16	2-1/2	11-3/8	6-3/8	7-1/2	1-13/16

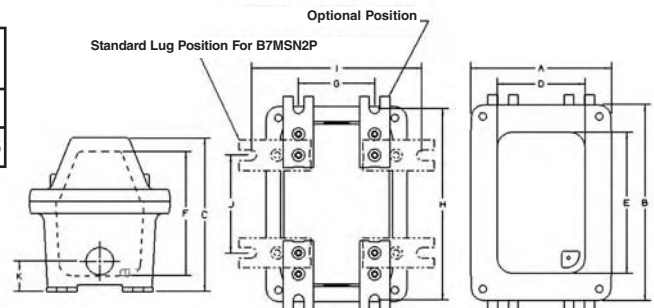

B7MSN Heater Selection^①		
Square D 2510M Only		
Motor Full Load AMPS @ 40°C		
Size 0		
CATALOG NUMBER	SINGLE PHASE	THREE PHASE
KB044	0.33 - 0.36	0.29 - 0.32
KB051	0.37 - 0.40	0.33 - 0.36
KB057	0.41 - 0.45	0.37 - 0.39
KB063	0.46 - 0.52	0.40 - 0.47
KB071	0.53 - 0.59	0.48 - 0.56
KB081	0.60 - 0.66	0.57 - 0.63
KB092	0.67 - 0.73	0.64 - 0.69
KB103	0.74 - 0.81	0.70 - 0.77
KB116	0.82 - 0.91	0.78 - 0.86
KB130	0.92 - 1.02	0.87 - 0.96
KB145	1.03 - 1.14	0.97 - 1.11
KB167	1.15 - 1.29	1.12 - 1.23
KB188	1.20 - 1.42	1.24 - 1.37
KB210	1.43 - 1.64	1.38 - 1.55
KB240	1.65 - 1.80	1.56 - 1.75
KB265	1.81 - 2.10	1.76 - 1.92
KB300	2.11 - 2.30	1.93 - 2.16
KB330	2.31 - 2.61	2.17 - 2.50
KB370	2.62 - 2.99	2.51 - 2.81
KB415	3.00 - 3.37	2.82 - 3.16
KB485	3.38 - 3.94	3.17 - 3.40
KB550	3.95 - 4.24	3.41 - 3.76
KB625	4.25 - 4.54	3.77 - 4.00
KB690	4.55 - 5.29	4.01 - 4.68
KB770	5.30 - 5.73	4.69 - 5.18
KB820	5.74 - 6.35	5.19 - 5.51
KB910	6.36 - 7.08	5.52 - 6.19
KB102	7.09 - 7.83	6.20 - 7.12
KB115	7.84 - 8.47	7.13 - 8.15
KB128	8.48 - 9.83	8.16 - 8.60
KB014	9.84 - 10.5	8.61 - 9.21
KB155	10.6 - 11.4	9.22 - 10.1
KB175	11.5 - 12.8	10.2 - 11.2
KB195	12.9 - 13.9	11.3 - 12.0
KB022	14.0 - 16.1	-----
KB025	16.2 - 18.0	-----
SIZE 1 & 1P	SIZE 1 & 1P	SIZE 1 & 1P
KB195	-----	11.3 - 12.1
KB022	-----	12.2 - 13.6
KB025	16.2 - 17.6	13.7 - 15.3
KB280	17.7 - 20.6	15.4 - 17.3
KB032	20.7 - 23.1	17.4 - 19.1
KB036	23.2 - 26.0	19.2 - 21.7
KB040	-----	21.8 - 24.2
KB045	-----	24.3 - 26.0
SIZE 1P	SIZE 1P	SIZE 1P
KB036	23.2 - 27.1	-----
KB040	27.2 - 29.2	-----
KB045	29.3 - 33.0	-----
KB050	33.1 - 36.0	-----

Catalog Logic

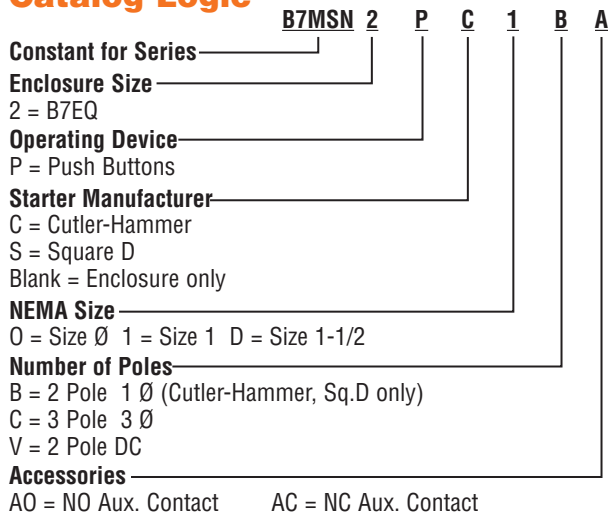

B7MSN Heater Selections
CUTLER-HAMMER

CATALOG NUMBER	MOTOR FULL-LOAD AMPS @ 40°C		CUTLER-HAMMER CODEMARK	CATALOG NUMBER	MOTOR FULL-LOAD AMPS @ 40°C		CUTLER-HAMMER CODEMARK
	SINGLE PHASE	THREE PHASE			SINGLE PHASE	THREE PHASE	
YOWEA200-FH03	.28-.29	.25-.26	FH03	YOWEA200-FH30	4.04-4.40	3.54-3.86	FH30
YOWEA200-FH04	.30-.33	.27-.29	FH04	YOWEA200-FH31	4.41-4.81	3.87-4.22	FH31
YOWEA200-FH05	.34-.36	.30-.32	FH05	YOWEA200-FH32	4.82-5.26	4.23-4.61	FH32
YOWEA200-FH06	.37-.40	.33-.35	FH06	YOWEA200-FH33	5.27-5.74	4.62-5.03	FH33
YOWEA200-FH07	.41-.45	.36-.39	FH07	YOWEA200-FH34	5.75-6.25	5.04-5.49	FH34
YOWEA200-FH08	.46-.50	.40-.44	FH08	YOWEA200-FH35	6.27-6.83	5.50-5.99	FH35
YOWEA200-FH09	.51-.56	.45-.49	FH09	YOWEA200-FH36	6.84-7.45	6.00-6.53	FH36
YOWEA200-FH10	.57-.63	.50-.55	FH10	YOWEA200-FH37	7.46-8.11	6.54-7.11	FH37
YOWEA200-FH11	.64-.70	.56-.61	FH11	YOWEA200-FH38	8.12-8.81	7.12-7.73	FH38
YOWEA200-FH12	.71-.78	.62-.68	FH12	YOWEA200-FH39	8.82-9.58	7.74-8.40	FH39
YOWEA200-FH13	.79-.86	.69-.75	FH13	YOWEA200-FH40	9.59-10.40	8.41-9.12	FH40
YOWEA200-FH14	.87-.95	.76-.83	FH14	YOWEA200-FH41	10.41-11.3	9.13-9.89	FH41
YOWEA200-FH15	.96-1.04	.84-.91	FH15	YOWEA200-FH42	11.4-12.2	9.9-10.7	FH42
YOWEA200-FH16	1.05-1.14	.92-1.00	FH16	YOWEA200-FH43	12.3-13.5	10.8-11.8	FH43
YOWEA200-FH17	1.15-1.25	1.01-1.10	FH17	YOWEA200-FH44	13.6-14.9	11.9-13.0	FH44
YOWEA200-FH18	1.26-1.39	1.11-1.22	FH18	YOWEA200-FH45	15.0-16.0	13.1-14.0	FH45
YOWEA200-FH19	1.40-1.54	1.23-1.35	FH19	YOWEA200-FH46	16.1-17.1	14.1-15.0	FH46
YOWEA200-FH20	1.55-1.71	1.36-1.50	FH20	YOWEA200-FH47	17.2-18.3	15.1-16.1	FH47
YOWEA200-FH21	1.72-1.89	1.51-1.66	FH21	YOWEA200-FH48	18.4-19.7	16.2-17.3	FH48
YOWEA200-FH22	1.90-2.10	1.67-1.84	FH22	YOWEA200-FH49	19.8-21.2	17.4-18.6	FH49
YOWEA200-FH23	2.11-2.32	1.85-2.03	FH23	YOWEA200-FH50	21.3-22.8	18.7-20.0	FH50
YOWEA200-FH24	2.33-2.54	2.04-2.23	FH24	YOWEA200-FH51	22.9-24.5	20.1-21.5	FH51
YOWEA200-FH25	2.55-2.79	2.24-2.45	FH25	YOWEA200-FH52	24.6-26.4	21.6-23.2	FH52
YOWEA200-FH26	2.80-3.07	2.46-2.69	FH26	YOWEA200-FH53	26.5-28.5	23.2-25.0	FH53
YOWEA200-FH27	3.08-3.36	2.70-2.95	FH27	YOWEA200-FH54	28.6-30.8	25.1-26.8	FH54
YOWEA200-FH28	3.37-3.68	2.96-3.23	FH28	YOWEA200-FH55	30.9-33.3	— — —	FH55
YOWEA200-FH29	3.69-4.03	3.24-3.53	FH29	YOWEA200-FH56	33.4-36.0	— — —	FH56
				YOWEA200-FH57	36.1-38.9	— — —	FH57

① Select heater element based on motor nameplate listed full load amps.
Trip rating of element is 125% of motor minimum F.L.A. listed for the element

**CUTLER HAMMER/EATON
B100 STARTERS FULL
VOLTAGE, NON-REVERSING
SINGLE AND POLYPHASE**

Applications

XMSW Series, non-reversing, manual line voltage starters and enclosures are suitable for use in applications requiring manual across-the-line starting and stopping of small single and polyphase AC motors, and where overload protection is needed. Manual starters are generally used on small machine tools, fans and blowers, pumps, compressors, and conveyors as well as many other types of electrical machinery.



Class I, Div. 1 & 2, Groups C,D
Class I, Zones 1 & 2, Groups IIB, IIA
Class II, Div. 1 & 2, Groups E,F,G
Class III
NEMA 3R, 7(C,D) 9(E,F,G)

Listed - File E12379

See files for details or call Killark.

FEATURES-SPECIFICATIONS

Features

- Rectangular bolted cover design provides for attractive, compact, uniform installations
- Enclosure and external handle are diecast copper-free (less than 0.4%) aluminum alloy
- Cast "ON," "OFF," "TRIPPED" markings on cover align with external handle and provide clear indication of enclosed starter condition
- External handle is a vault type with standard provisions for locking in the "OFF" position with up to three pad-locks. Provision for locking in "ON" position is available as factory modification (add suffix SU-40 to catalog number).
- Two cast 1" NPT conduit hubs with integral pipe stop, one top and one bottom, are standard on all assemblies

Electrical Rating

Starter sizes 0, 1, 11/2

Two pole, single phase; three pole, polyphase

Maximum 10 HP, 600 Volts AC

Dimensions

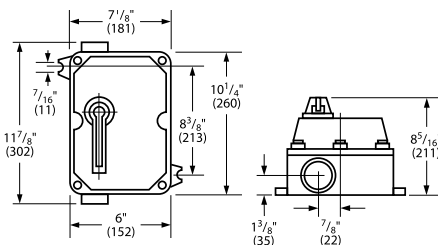

① Select heater element based on motor nameplate listed. Full-load amps. Trip rating of element is 125% of motor minimum F.L.A. listed for the element.

XMSW MANUAL LINE STARTERS ① ②						
NEMA SIZE	NUMBER OF POLE SIZE	MAXIMUM HORSEPOWER			CATALOG NUMBER	
		120 VAC	208-240 VAC	480-600 VAC	WITH STARTER	ENCLOSURE ONLY
0	2-POLE; 1Ø, A C	1	2	—	XMSW-0BT	XMSW-00T
0	3-POLE; 3Ø, A C	2	3	5	XMSW-0CT	
1	2-POLE; 1Ø, A C	2	3	—	XMSW-1BT	
1	3-POLE; 3Ø, A C	3	7-1/2	10	XMSW-1CT	
1-1/2	2-POLE; 1Ø, A C	3	5	—	XMSW-DBT	

① Heaters not included. If heaters are required order as separate item by catalog number, three phase starters require three heaters. Single phase starters require two heaters.

② Three pole starters may be used on two-phase four-wire circuits by running one wire direct to motor.

HEATER TABLE FOR XMSW SERIES MANUAL LINE STARTERS ①							
CATALOG NUMBER	MOTOR FULL-LOAD AMPS @ 40°C		CUTLER HAMMER	CATALOG NUMBER	MOTOR FULL-LOAD AMPS @ 40°C		CUTLER HAMMER
	SINGLE PHASE	THREE PHASE			SINGLE PHASE	THREE PHASE	
YOWEA200-FH03	.28-.29	.25-.26	FH03	YOWEA200-FH30	4.04-4.40	3.54-3.86	FH30
YOWEA200-FH04	.30-.33	.27-.29	FH04	YOWEA200-FH31	4.41-4.81	3.87-4.22	FH31
YOWEA200-FH05	.34-.36	.30-.32	FH05	YOWEA200-FH32	4.82-5.26	4.23-4.61	FH32
YOWEA200-FH06	.37-.40	.33-.35	FH07	YOWEA200-FH33	5.27-5.74	4.62-5.03	FH33
YOWEA200-FH07	.41-.45	.36-.39	FH07	YOWEA200-FH34	5.75-6.25	5.04-5.49	FH34
YOWEA200-FH08	.46-.50	.40-.44	FH08	YOWEA200-FH35	6.27-6.83	5.50-5.99	FH35
YOWEA200-FH09	.51-.56	.45-.49	FH09	YOWEA200-FH36	6.84-7.45	6.00-6.53	FH36
YOWEA200-FH10	.57-.63	.50-.55	FH10	YOWEA200-FH37	7.46-8.11	6.54-7.11	FH37
YOWEA200-FH11	.64-.70	.56-.61	FH11	YOWEA200-FH38	8.12-8.81	7.12-7.73	FH38
YOWEA200-FH12	.71-.78	.62-.68	FH12	YOWEA200-FH39	8.82-9.58	7.74-8.40	FH39
YOWEA200-FH13	.79-.86	.69-.75	FH13	YOWEA200-FH40	9.59-10.40	8.41-9.12	FH40
YOWEA200-FH14	.87-.95	.76-.83	FH14	YOWEA200-FH41	10.41-11.3	9.13-9.89	FH41
YOWEA200-FH15	.96-1.04	.84-.91	FH15	YOWEA200-FH42	11.4-12.2	9.9-10.7	FH42
YOWEA200-FH16	1.05-1.14	.92-1.00	FH16	YOWEA200-FH43	12.3-13.5	10.8-11.8	FH43
YOWEA200-FH17	1.15-1.25	1.01-1.10	FH17	YOWEA200-FH44	13.6-14.9	11.9-13.0	FH44
YOWEA200-FH18	1.26-1.39	1.11-1.22	FH18	YOWEA200-FH45	15.0-16.0	13.1-14.0	FH45
YOWEA200-FH19	1.40-1.54	1.23-1.35	FH19	YOWEA200-FH46	16.1-17.1	14.1-15.0	FH46
YOWEA200-FH20	1.55-1.71	1.36-1.50	FH20	YOWEA200-FH47	17.2-18.3	15.1-16.1	FH47
YOWEA200-FH21	1.72-1.89	1.51-1.66	FH21	YOWEA200-FH48	18.4-19.7	16.2-17.3	FH48
YOWEA200-FH22	1.90-2.10	1.67-1.84	FH22	YOWEA200-FH49	19.8-21.2	17.4-18.6	FH49
YOWEA200-FH23	2.11-2.32	1.85-2.03	FH23	YOWEA200-FH50	21.3-22.8	18.7-20.0	FH50
YOWEA200-FH24	2.33-2.54	2.04-2.23	FH24	YOWEA200-FH51	22.9-24.5	20.1-21.5	FH51
YOWEA200-FH25	2.55-2.79	2.24-2.45	FH25	YOWEA200-FH52	24.6-26.4	21.6-23.2	FH52
YOWEA200-FH26	2.80-3.07	2.46-2.69	FH26	YOWEA200-FH53	26.5-28.5	23.2-25.0	FH53
YOWEA200-FH27	3.08-3.36	2.70-2.95	FH27	YOWEA200-FH54	28.6-30.8	25.1-26.8	FH54
YOWEA200-FH28	3.37-3.68	2.96-3.23	FH28	YOWEA200-FH55	30.9-33.3	— —	FH55
YOWEA200-FH29	3.69-4.03	3.24-3.53	FH29	YOWEA200-FH56	33.4-36.0	— —	FH56
				YOWEA200-FH57	36.1-38.9	— —	FH57

