

PRODUCT SPECIFICATIONS / INFO

LEVITON



Color: Black-White



NEMA: 5-15P



8215-C

UPC Code: 07847779526

Country of Origin: United States - **Eligible for ARRA funded projects*

Description

15 Amp, 125 Volt, NEMA 5-15P, 2P, 3W, Plug, Straight Blade, Hospital Grade, Grounding, - Black-White

Product Features

NEMA: 5-15P

Color: Black-White



**Disclaimer*

Electrical Specifications	
Grounding	Grounding
Amperage	15 Amp
Voltage	125 Volt
Pole	2
Wire	3
Temperature Rise	Max 30C after 250 cycles OL at 200 percent rated current
Dielectric Voltage	Withstands 2000V per UL498
Current Interrupting	Certified for current interrupting at full rated current

Environmental Specifications	
Flammability	Rated V-2 per UL94
Operating Temperature	-40C to 60C

Mechanical Specifications	
Terminal ID	Brass-Hot, Green-Ground, White-Neutral
Terminal Accom.	18-10 AWG
Product ID	Ratings and NEMA I.D. permanently marked on device
Cord Range	.245 - .700

Material Specifications	
Body Material	Super Tough Nylon
Back Cover	Thermoplastic
Wire Module	Nylon
Cord-Clamp	Nylon
Clamp Insert	Nylon
Blades/Contacts	Solid Brass
Terminal Screws	Brass
Assembly Screws	Steel, Zinc Plated
Color	Black-White

Standards and Certifications	
NEMA	WD-6
ANSI	C-73
UL 498	File E13399
UL Fed Spec WC-596	File E13393
CSA C22.2 No. 42	File LR-406
NOM	057
Warranty	Lifetime Warranty

Dimensional Diagram

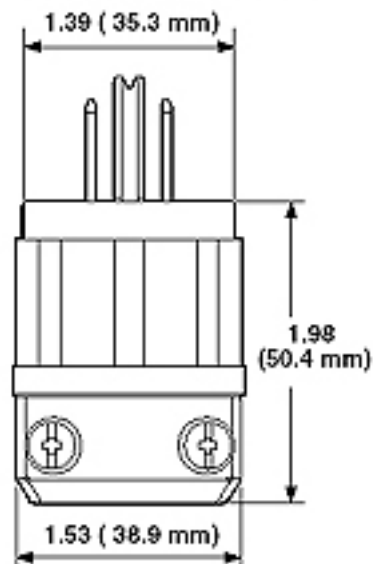

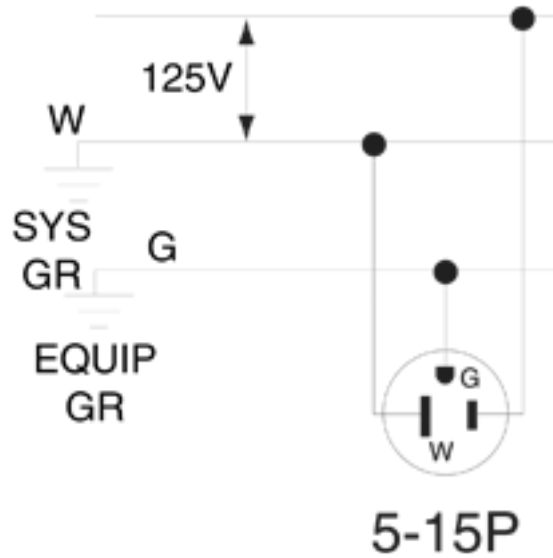

SPECIFICATION SUBMITTAL

JOB NAME:	CATALOG NUMBERS:	
<input type="text"/>	<input type="text"/>	<input type="text"/>
JOB NUMBER:	<input type="text"/>	<input type="text"/>

Leviton Manufacturing Co., Inc.

201 North Service Road, Melville, NY 11747

Telephone: 1-800-323-8920 · FAX: 1-800-832-9538 · Tech Line (8:30AM-7:30PM E.S.T. Monday-Friday): 1-800-824-3005

Leviton Manufacturing of Canada, Ltd.

165 Hymus Boulevard, Pointe Claire, Quebec H9R 1E9 · Telephone: 1-800-469-7890 · FAX: 1-800-824-3005 · www.leviton.com/canada

Leviton S. de R.L. de C.V.

Lago Tana 43, Mexico DF, Mexico CP 11290 · Tel.: (+52)55-5082-1040 · FAX: (+52)5386-1797 · www.leviton.com.mx

Visit our Website at: www.leviton.com

© 2007-2016 Leviton Manufacturing Co., Inc. All rights reserved. Subject to change without notice.

Leviton has a global presence.

If you would like to know where your local Leviton office is located please go to:
www.leviton.com/international/contacts/



**Buy American Compliant Logo -- The American Recovery And Reinvestment Act of 2009 ("ARRA") provides federal grants and loans for projects throughout the country. Section 1605 of the Act, named the "Buy American" provision, requires that certain materials and manufactured products used in projects funded by the Act be manufactured in the United States. The appearance of the Recovery Act Logo in relation to a Leviton product is only intended to reflect that such product may be used in an ARRA funded project. It does not mean that such product or Leviton is sponsored or endorsed by, or that Leviton receives funds from, the federal government or the Recovery Accountability and Transparency Board. Nothing in Leviton's use of the logo is intended to suggest anything regarding the requirements for funding under ARRA.*