

WIRE RANGE TABLE:

CONNECTOR	COPPER		ALUMINUM		
	SOLID	STRAND	SOLID	STRAND	
LINE	14-8	14-2	12-8	12-2	
LOAD	14-10	14-10	-----	-----	
NEUTRAL	END HOLE	14-8	14-2	12-8	12-2
NEUTRAL	SIDE HOLE	14-8	14-4	12-8	12-4
EQUIP. GRND.		12-8	12-2	12-8	12-2

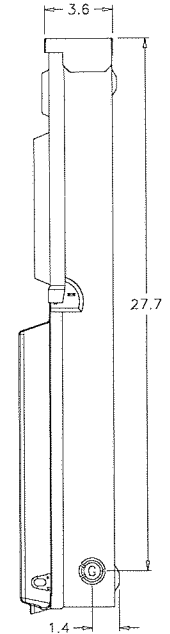
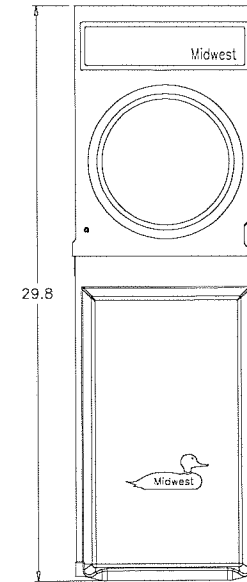
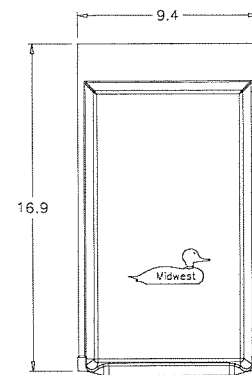
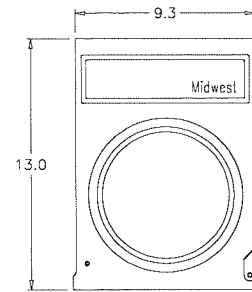
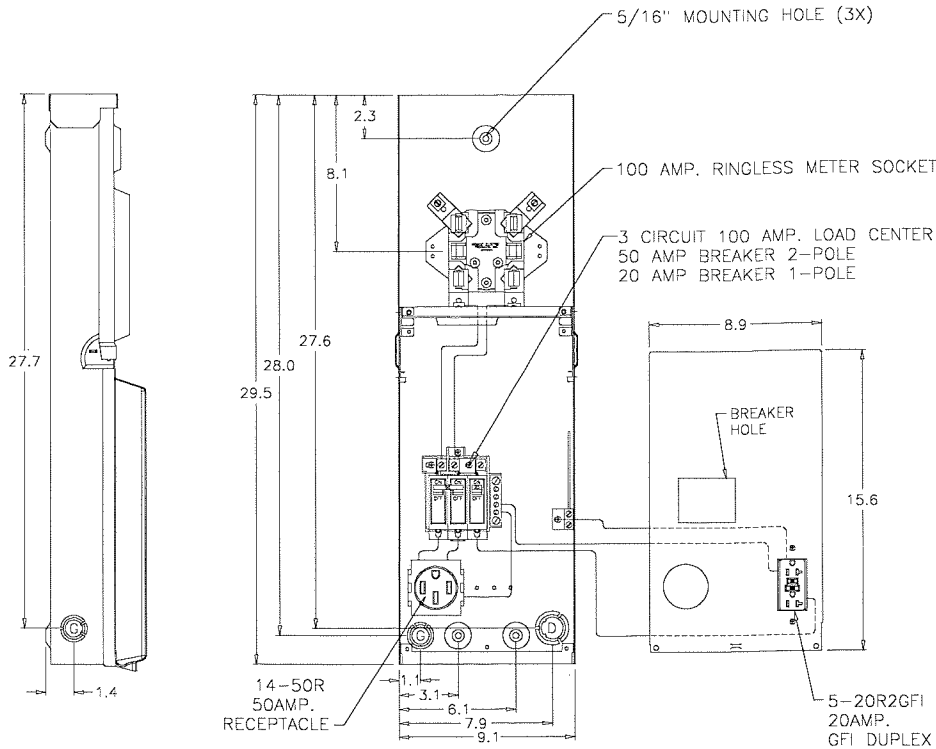

KNOCKOUT TABLE:

- G= 1/2", 3/4", 1" KO
- B= 1", 1-1/4", 1-1/2" KO
- D= 3/4", 1", 1-1/4" KO
- H= 9/16" KO

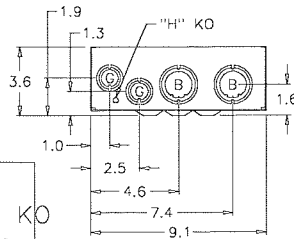

SH50

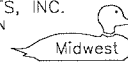
MIDWEST ELECTRIC PRODUCTS, INC. Mankato, MN 	* = Critical To Quality Unless Otherwise Specified Tolerances On: 3 Pl. Decimals ± .010 2 Pl. Decimals ± .030 Fractions ± 1/32 Angles ± 1/2 Holes ± .003 Dimensions Are In Inches	AutoCad Generated		TITLE: R055C010 OUTLINE DRAWING DWG NO: 265A6227
		SCALE: 1 : 1	SIZE: A	
Dr. By: JDE Ck. By: CR: R0B14112	SHEET 1 OF 1			

Rev.1 CR R0B14112 JE 2-19-06
 Rev.2 CR R110661B IB 09-19-11

X