

# GUA Conduit Outlet Boxes

## Explosionproof, Dust-Ignitionproof

### NEC/CEC:

Class I, Division 1 and 2, Groups B♦, C, D  
Class II, Division 1 and 2, Groups E, F, G  
Class III  
NEMA 3, 4

### Applications

- To provide access to conductors for pulling, splicing, maintenance and future changes and upgrades.
- Allows connection of straight conduit runs, branch conduit runs and 90° bends.

### Features

- O-ring gasket provided to assure NEMA 4 rating.
- Internal ground screw.
- Smooth hub bushings protect insulation when pulling conductors.
- Cast-in brackets on cover for use with breaker-bar tools for tightening/loosening.
- Tapered threaded hubs (NPT).
- Threaded for rigid conduit or IMC.

### Standard Materials

- 1/2" thru 1" Body: copperfree (4/10 of 1% max.) aluminum
- 1/2" thru 1" Cover: malleable iron
- 1/2" thru 2" Body and cover: malleable iron

### Standard Finishes

- Malleable iron bodies and covers: triple-coat — (1) zinc electroplate, (2) chromate, and (3) epoxy powder coat
- Aluminum bodies and covers: epoxy powder coat

### NEC/CEC Certifications and Compliances

- UL Standard: 886
- UL Listed: E-85310
- CSA Standard: C22.2 No. 30
- CSA Certified: 020945
- NEMA 7CD, 9EFG
- NEC Articles 500-503 and 505



OZGEDNEY

ENCLOSURES AND JUNCTION BOXES: NEC/CEC EXPLOSIONPROOF ENCLOSURES

♦ In Class I, Division 1, Group B atmospheres, all conduit runs must have a sealing fitting (not supplied) field-installed adjacent to the enclosure.







# GUA Conduit Outlet Boxes

## Explosionproof, Dust-Ignitionproof

NEC/CEC:  
 Class I, Division 1 and 2, Groups B♦, C, D  
 Class II, Division 1 and 2, Groups E, F, G  
 Class III  
 NEMA 3, 4

OZGEDNEY

ENCLOSURES AND JUNCTION BOXES: NEC/CEC EXPLOSIONPROOF ENCLOSURES

		Catalog Number			
	Hub Type	Trade Size (Inches)	Form	Malleable Iron Body With Aluminum Cover	Malleable Iron Body and Cover
	GUAE	1/2	1	GUAE-50	GUAE-50MC
		3/4	1	GUAE-75	GUAE-75MC
		1	1	GUAE-100	GUAE-100MC
	GUAC	1/2	1	GUAC-50	GUAC-50MC
		3/4	1	GUAC-75	GUAC-75MC
		1	1	GUAC-100	GUAC-100MC
		1-1/4	2	—	GUAC-125
		1-1/2	3	—	GUAC-150
2	3	—	GUAC-200		
	GUAL	1/2	1	GUAL-50	GUAL-50MC
		3/4	1	GUAL-75	GUAL-75MC
		1	1	GUAL-100	GUAL-100MC
		1-1/4	2	—	GUAL-125
		1-1/2	3	—	GUAL-150
2	3	—	GUAL-200		
	GUALB	1/2	1	GUALB-50	GUALB-50MC
		3/4	1	GUALB-75	GUALB-75MC
		1	1	GUALB-100	GUALB-100MC
		1-1/4	2	—	GUALB-125
		1-1/2	3	—	GUALB-150
2	3	—	GUALB-200		
	GUAT	1/2	1	GUAT-50	GUAT-50MC
		3/4	1	GUAT-75	GUAT-75MC
		1	1	GUAT-100	GUAT-100MC
		1-1/4	2	—	GUAT-125
		1-1/2	3	—	GUAT-150
2	3	—	GUAT-200		
	GUAX	1/2	1	GUAX-50	GUAX-50MC
		3/4	1	GUAX-75	GUAX-75MC
		1	1	GUAX-100	GUAX-100MC
		1-1/4	2	—	GUAX-125
		1-1/2	3	—	GUAX-150
2	3	—	GUAX-200		

♦ In Class I, Division 1, Group B atmospheres, all conduit runs must have a sealing fitting (not supplied) field-installed adjacent to the enclosure.

# GUA Conduit Outlet Boxes

## Explosionproof, Dust-Ignitionproof

NEC/CEC:  
 Class I, Division 1 and 2, Groups B♦, C, D  
 Class II, Division 1 and 2, Groups E, F, G  
 Class III  
 NEMA 3, 4

### Dimensions in Millimeters (Inches)

Hub Size (Inches)	Dimensions in Millimeters (Inches)						
	A	B	C	D	E	F	G
<b>Type GUA, Form 1</b>							
1/2	95.3 (3.75)	62.0 (2.44)	73.2 (2.88)	19.1 (0.75)	20.6 (0.81)	57.2 (2.25)	31.8 (1.25)
3/4	95.3 (3.75)	62.0 (2.44)	73.2 (2.88)	19.1 (0.75)	20.6 (0.81)	57.2 (2.25)	31.8 (1.25)
1	95.3 (3.75)	62.0 (2.44)	73.2 (2.88)	19.1 (0.75)	20.6 (0.81)	57.2 (2.25)	31.8 (1.25)
<b>Type GUA, Form 2</b>							
1-1/4	114.3 (4.50)	68.3 (2.69)	90.4 (3.56)	30.2 (1.19)	22.4 (0.88)	69.9 (2.75)	28.7 (1.13)
<b>Type GUA, Form 3</b>							
1-1/2	146.1 (5.75)	95.3 (3.75)	122.2 (4.81)	35.1 (1.38)	23.9 (0.94)	103.1 (4.06)	38.1 (1.50)
2	146.1 (5.75)	101.6 (4.00)	128.5 (5.06)	41.4 (1.63)	25.4 (1.00)	108.0 (4.25)	31.8 (1.25)

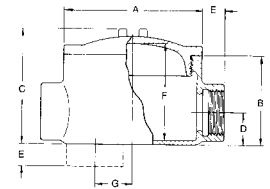
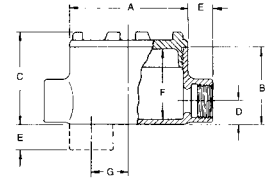

OZGEDNEY

ENCLOSURES AND JUNCTION BOXES: NEC/CEC EXPLOSIONPROOF ENCLOSURES

♦ In Class I, Division 1, Group B atmospheres, all conduit runs must have a sealing fitting (not supplied) field-installed adjacent to the enclosure.

# GUA Conduit Outlet Box Covers

## For Pendant Mounting Fixtures. Explosionproof, Dust-Ignitionproof

UNILETS™ for use with Threaded Metal Conduit. Furnished with Internal Ground Screw and O-ring.

### NEC/CEC:

Class I, Division 1 and 2, Groups C, D  
Class I, Zone 1 and 2, Groups IIA, IIB  
Class II, Division 1 and 2, Groups E, F, G  
Class III

### Applications

- Provides NPT thread hub for mounting pendant light fixtures (luminaires) on 1/2", 3/4" and 1" trade size Type GUA outlet boxes.
- Provides additional wiring space and NPT threaded hub for mounting pendant light fixtures (luminaires) on 1/2", 3/4" and 1" trade size Type GUA outlet boxes.

### Features

- O-ring gasket provided to assure watertightness.
- Increases internal wiring volume (12.5 cu. in.).
- Side port allows access to conductors after fixture is mounted.
- Tapered threaded hub (NPT).
- Provided with anti-rotation set-screws.
- Maximum weight capacity: 22.7 kg (50 lbs.) per NEC Section 314-27(B).

### Standard Materials

- Bodies: malleable Iron
- Screws: steel set screws
- O-ring: buna-n

### Standard Finishes

- Bodies: zinc electroplate

### Options

- Hot dip or mechanical galvanized. Add suffix **-G** to standard catalog number. Contact your local representative for pricing and availability.

### NEC/CEC Certifications and Compliances

- UL Standard: 886
- UL Listed: E-97032
- CSA Standard: C22.2 No. 30
- CSA Certified: 020945
- Fed. Spec: A-A-50563
- NEC Articles 500-503 and 505

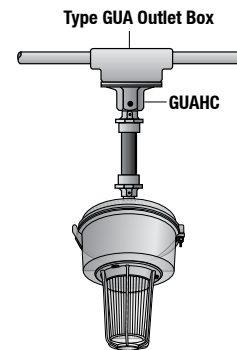
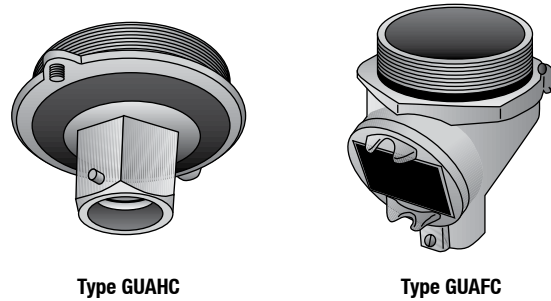



# GUA Conduit Outlet Box Covers

For Pendent Mounting Fixtures. Explosionproof, Dust-Ignitionproof

UNILETS™ for use with Threaded Metal Conduit. Furnished with Internal Ground Screw and O-ring.

**NEC/CEC:**

Class I, Division 1 and 2, Groups C, D  
 Class I, Zone 1 and 2, Groups IIA, IIB  
 Class II, Division 1 and 2, Groups E, F, G  
 Class III

	Hub Type	Conduit Size (Inches)	Catalog Number
	GUAHC	1/2	GUAHC-50
		3/4	GUAHC-75
	GUAFC	1/2	GUAFC-50
		3/4	GUAFC-50

**Dimensions in Millimeters (Inches)**

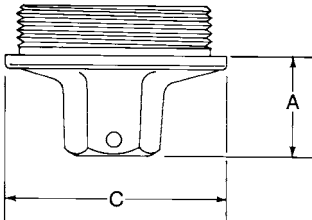
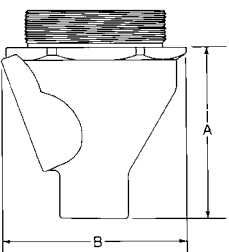
Hub Size (Inches)	Dimensions in Millimeters (Inches)			
	A	B	C Max. Dia	
<b>GUAHC</b>				
1/2	41.4 (1.63)	—	88.9 (3.50)	
3/4	41.4 (1.63)	—	88.9 (3.50)	
<b>GUAFC</b>				
1/2	—	41.4 (1.63)	88.9 (3.50)	
3/4	—	41.4 (1.63)	88.9 (3.50)	

**OZGEDNEY**

ENCLOSURES AND JUNCTION BOXES: NEC/CEC EXPLOSIONPROOF ENCLOSURES

# GUA Conduit Outlet Box Covers

## Sealing Cover

### NEC/CEC:

Class I, Division 1 and 2, Groups C, D  
Class I, Zone 1 and 2, Groups IIA, IIB  
Class II, Division 1 and 2, Groups E, F, G  
Class III

### Applications

- Converts 1/2", 3/4" and 1" trade size Type GUA malleable iron outlet boxes into 25% fill sealing fittings.

### Features

- Removable plug for pouring sealing compound.
- O-ring gasket provided to assure watertightness.
- Can be used with O-Z/Gedney EYC sealing compound.

### Standard Materials

- Body: malleable iron
- Screws: steel set screws
- O-ring: buna-n

### Standard Finishes

- Body: zinc electroplated

### Options

- Hot dip or mechanical galvanized. Add suffix **-G** to standard catalog number. Contact your local representative for pricing and availability.

### NEC/CEC Certifications and Compliances

- UL Standard: 886
- UL Listed: E-97032
- CSA Standard: C22.2 No. 30
- CSA Certified: 020945
- NEC Articles 500-503 and 505
- Fed. Spec: A-A-50563

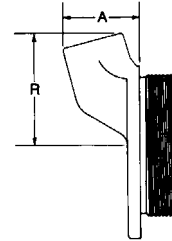
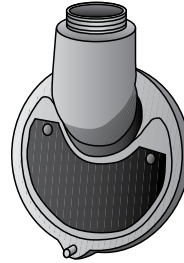

#### Dimensions in Millimeters (Inches)

Turning Radius  
R

Maximum Body Height  
A

Catlog Number

63.5 (2.5)

44.5 (1.75)

**GUASC-1**

# GUA Conduit Outlet Box Covers

## Threaded Extension

### NEC/CEC:

Class I, Division 1 and 2, Groups C, D  
Class I, Zone 1 and 2, Groups IIA, IIB  
Class II, Division 1 and 2, Groups E, F, G  
Class III

### Applications

- Provides for increased internal wiring volume in 1/2", 3/4" and 1" trade size in Type GUA malleable iron outlet boxes

### Features

- O-ring gasket provided to assure watertightness.
- Cast-in brackets for use with breaker bar tools.
- Increases internal wiring volume by 11 cu. in.

### Standard Materials

- Cover: malleable iron
- O-ring: buna-n

### Standard Finishes

- Cover: zinc electroplate

### Options

- Hot dip or mechanical galvanized. Add suffix **-G** to standard catalog number. Contact your local representative for pricing and availability.

### NEC/CEC Certifications and Compliances

- UL Standard: 886
- UL Listed: E-97032
- CSA Standard: C22.2 No. 30
- CSA Certified: 043437
- NEC Articles 500-503 and 505
- Fed. Spec: A-A-50563

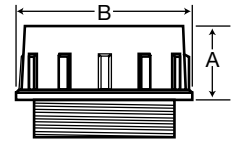

Dimensions in Millimeters (Inches)			
A	Maximum Diameter B	Volume (in <sup>3</sup> )	Catalog Number
69.9 (2.75)	88.9 (3.5)	11	GUADC-1