



Enterprise Grade Commercial Products

Index

Network Wiring	Page
Enterprise Grade Commercial Products	
Modular Keystone Jacks	W-2
Audio/Video Keystone Connectors	W-3
Hubbell iSTATION Face Plates	W-5
Hubbell iSTATION Outlet Frames	W-6
HDMI Connectors and Audio/Video Modules	W-7
Hubbell iSTATION Audio/Video Modules	W-8
Hubbell iSTATION Front-Loading Frames and Modules	W-9
Hubbell iSTATION Surface Mount Boxes	W-10
Universal Patch Panels	W-11
Standard UTP Wiring Conventions	W-12
netSELECT® Products	W-13
Structured Wiring	
In-Wall AV Delivery	W-14
HDMI Products	W-15
Advantages and Wiring Layout	W-16
Network Enclosures	W-17
Network Modules	W-18
Audio/Video Modules	W-19
Universal Consolidation Blocks, Patch Panels and Patch Cords	W-20
Accessories	W-21
Data Communications and Audio/Video	
Modular Snap Fit Jacks	W-22
Decorator Frames	W-23
Molded-In Voice/Data/Video	W-24
Molded-In Plates	W-25
Telephone Wall Jacks	W-26

Keystone Jacks and Connectors



HDMI Connectors



Hubbell iSTATION Surface Mount Boxes



Modular Snap Fit Jacks





HXJ6B



HXJ6OR

Hubbell Xcelerator Jacks, Category 6

The NEXTSPEED® Category 6 system is designed to deliver headroom beyond 500MHz for dependable Multi-gigabit Ethernet applications. NEXTSPEED's extended bandwidth provides reliability with zero bit error rate performance for today's high speed digital communications.

Color	Catalog Number	Bag of 25 Catalog Number
Almond	HXJ6AL	HXJ6AL25
Black	HXJ6BK	HXJ6BK25
Blue	HXJ6B	HXJ6B25
Gray	HXJ6GY	HXJ6GY25
Green	HXJ6GN	HXJ6GN25
Ivory	HXJ6EI	HXJ6EI25
Light Almond	HXJ6LA	HXJ6LA25
Office White	HXJ6OW	HXJ6OW25
Orange	HXJ6OR	HXJ6OR25
Red	HXJ6R	HXJ6R25
White	HXJ6W	HXJ6W25
Yellow	HXJ6Y	HXJ6Y25

Hubbell Xcelerator Jacks, Category 5e

Supports 10/100/1000BASE-T applications with usable bandwidth of 190 MHz in the channel.

Color	Catalog Number	Bag of 25 Catalog Number
Almond	HXJ5EAL	HXJ5EAL25
Black	HXJ5EBK	HXJ5EBK25
Blue	HXJ5EB	HXJ5EB25
Gray	HXJ5EGY	HXJ5EGY25
Green	HXJ5EGN	HXJ5EGN25
Ivory	HXJ5EEI	HXJ5EEI25
Light Almond	HXJ5ELA	HXJ5ELA25
Office White	HXJ5EOW	HXJ5EOW25
Orange	HXJ5EOR	HXJ5EOR25
Red	HXJ5ER	HXJ5ER25
White	HXJ5EW	HXJ5EW25
Yellow	HXJ5EY	HXJ5EY25



HXJ5EBK

Hubbell Xcelerator Jacks, 6-Position USOC

Color	Catalog Number	Bag of 25 Catalog Number
Almond	HXJUAL	-
Black	HXJUBK	-
Blue	HXJUB	-
Gray	HXJUGY	-
Green	HXJUGN	-
Ivory	HXJUEI	-
Light Almond	HXJULA	-
Office White	HXJUOW	HXJUOW25
Orange	HXJUOR	-
Red	HXJUR	-
White	HXJUW	-
Yellow	HXJUY	-



HXJUEI

Jack Icons*

Bag of 100 icons. Snaps to front of enterprise grade Hubbell Xcelerator jacks.



Color	Blank	Computer	Telephone
Black	IBK100	IBK100C	IBK100T
Blue	IB100	IB100C	IB100T
Brown	IBN100	IBN100C	IBN100T
Gray	IGY100	IGY100C	IGY100T
Green	IGN100	IGN100C	IGN100T
Ivory	IEI100	IEI100C	IEI100T
Orange	IOR100	IOR100C	IOR100T
Purple	IP100	IP100C	IP100T
Red	IR100	IR100C	IR100T
White	IW100	IW100C	IW100T
Yellow	IY100	IY100C	IY100T

Note: *Not UL Listed, CSA Certified.



IP100C



F-Type Connectors

Distributes high quality video signal to the workstation. These connectors install with a snap and provide quick, easy “screw-on” termination. Compatible with TV, CATV and CCTV, home theater and entertainment systems, satellite, security and surveillance systems, VCR/DVD applications.

Color	F-Type Coupler Bulkhead F/F	F-Type Coupler Bulkhead F/F Gold	F-Type to RCA Bulkhead F/F Gold	F-Type Recessed
Almond	SFFALX	SFFGAL	–	–
Black	SFFBX	SFFGBK	SFRFGBK	SFGRFBK
Gray	SFFGX	SFFGGY	SFRFGGY	SFGRFGY
Ivory	SFFEX	SFFGEI	SFRFGEI	SFGRFEI
Light Almond	SFFLAX	SFFGLA	–	–
Office White	SFFX	SFFGOW	SFRFGOW	SFGRFOW
White	SFFWX	SFFGW	SFRFGW	SFGRFW



SFFGGY



SFGRFOW



SFR110R



SFRRCR



SFRRCROW



SFRRCRF



SFSV110BK

RCA Connectors

Distributes component and composite audio and video signals from device to device. Typical applications include TV, cable, VCR/DVD, camera, camcorder, projector, home theater, and entertainment centers.

Insulator Color	RCA 110 Punch-Down Black Housing	RCA Solder Coupler Termination		
		Office White Housing	Additional Housing Color*	RCA Recessed*
Black	–	SFRC	SFRCBKxx	SFRCBKRxx
Blue	SFRC110B	SFRCBOW	SFRCBxx	SFRCBRxx
Green	SFRC110GN	SFRCGNOW	SFRCGNxx	SFRCGNRxx
Orange	–	SFRCOROW	SFRCORxx	SFRCORRxx
Red	SFRC110R	SFRCR	SFRCRxx	SFRCRRxx
White	SFRC110W	SFRCW	SFRCWxx	SFRCWRxx
Yellow	SFRC110Y	SFRCY	SFRCYxx	SFRCYRxx

Insulator Color	RCA Gold Pass-through, Office White Housing	F/F Coupler Additional Housing Color*
Black	SFRCBKFF	SFRCBKFFxx
Blue	SFRCBFFOW	SFRCBFFxx
Green	SFRCGNFFOW	SFRCGNFFxx
Orange	SFRCORFFOW	SFRCORFFxx
Red	SFRCRFF	SFRCRFFxx
White	SFRCWFF	SFRCWFFxx
Yellow	SFRCYFF	SFRCYFFxx

Note: *Additional Housing colors: **xx** = **AL** (Almond), **BK** (Black), **EI** (Ivory), **GY** (Gray), **LA** (Light Almond), and **W** (White).

S-Video Connectors

Transmits video information over a cable by dividing the signal into two separate signals (chrominance) for color and (luminance) for brightness. Applications include cable, satellite, DVD, camera, camcorder, projector, home theater, entertainment systems, security, and surveillance.

Color	S-Video 110 Punch-Down	S-Video F/F Coupler
Black	SFSV110BK	SFSVBK

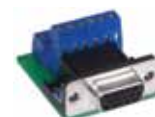

Gender Changers, 9 and 15-Pin Connections

Unit of Measure	15-Pin, 90° F/F Coupler	HD 9-Pin F/F Coupler	HD 15-Pin F/F Coupler
1 per bag	15901	–	–
10 per bag	159010	9GC10	15GC10

Screw Terminal, 9 and 15-Pin Connections

Unit of Measure	HD 9-Pin Screw Term	HD 15-Pin Screw Term	HD 15-Pin, Screw Term, Keystone Front Mount
10 per bag	9ST10	15ST10	SF15ST

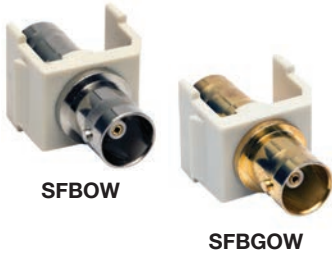

SFBBOW

SFBGOW



SFSPGR

SPPBK10



SF35FFOW

SF35STOW



SFC5EW

SFC6EBK

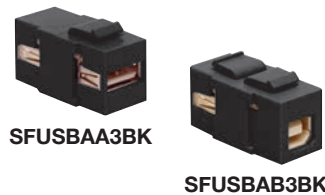

SFUSBAA3BK

SFUSBAB3BK

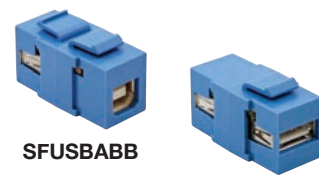

SFUSBABB

SFUSBAAB

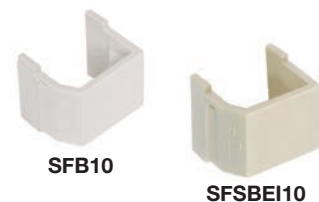

SFB10

SFSBEI10

BNC Connectors

Distributes PRO audio video through coaxial 75 ohm signal to the work area. Applications include TV, CCTV, analog and digital CATV, VCR, HDTV satellite, security and surveillance systems.

Color	BNC Connector Nickel Finish	BNC Connector Gold Finish
Black	SFBBK	SFBGBK
Gray	SFBGY	SFBGGY
Ivory	SFBEI	SFBGEI
Light Almond	SFBLA	SFBGLA
Office White	SFBOW	SFBGOW
White	SFBW	SFBGW

Gold Speaker Post Connectors and Plugs*

Ring Color	Speaker Post Connector Office White Housing	Speaker Post/ Banana Plugs
Black	SFSPGBK	SPPBK10
Red	SFSPGR	SPPR10

3.5mm Stereo Jacks*

Distributes stereo or mono audio signals to and from devices. Applications include laptop and desktop computer audio I/O output, PRO audio distribution, projectors, and IR (infrared) signal transmission.

Housing Color	3.5mm F/F Coupler	3.5mm Stereo Jack	3.5mm Screw Term.
Black	SF35FFBK	SF35SJBK	SF35STBK
Gray	SF35FFGY	SF35SJGY	SF35STGY
Ivory	SF35FFEI	SF35SJEI	SF35STEI
Light Almond	SF35FFLA	SF35SJLA	SF35STLA
Office White	SF35FFOW	SF35SJ	SF35STOW
White	SF35FFW	SF35SJW	SF35STW

Inline Couplers*

Use to deliver a quick and easy interconnect solution at the desktop or in the cross connect.

Color	Wiring: T568A/B	Wiring: T568A/B
Black	SFC5EBK	SFC6EBK
White	SFC5EW	SFC6EW

USB Connectors

Use to provide a simple and easy way to add a USB connection to a work area.

Housing Color	USB 3.0, A to A, Pass-Thru, F/F, Coupler	USB 3.0, A to B, Pass-Thru, F/F, Coupler	USB 2.0, A to A, Pass-Thru, F/F, Coupler	USB 2.0, A to B, Pass-Thru, F/F, Coupler
Black	SFUSBAA3BK	SFUSBAB3BK	-	-
Blue	-	-	SFUSBAAB	SFUSBABB
Office White	-	-	SFUSBAAOW	SFUSBABOW
White	-	-	SFUSBAAW	SFUSBABW

Blank Connectors, 10-Pack

Housing Color	Blanks	Smooth Blanks
Almond	SFBAL10	SFSBAL10
Black	SFB10	SFSBBK10
Gray	SFBG10	SFSBGY10
Ivory	SFBE10	SFSBEI10
Light Almond	SFBLA10	SFSBLA10
Office White	SFB10	SFSBOW10
White	SFBW10	SFSBW10

Note: *Not UL Listed.



IFP Face Plates, with Label Fields, 1- and 2-Gang



Color	1-Gang					2-Gang		
	1-Port	2-Port	3-Port	4-Port	6-Port	6-Port	9-Port	12-Port
Almond	IFP11AL	IFP12AL	IFP13AL	IFP14AL	IFP16AL	IFP26AL	-	-
Black	IFP11BK	IFP12BK	IFP13BK	IFP14BK	IFP16BK	IFP26BK	IFP29BK	IFP212BK
Gray	IFP11GY	IFP12GY	IFP13GY	IFP14GY	IFP16GY	IFP26GY	IFP29GY	IFP212GY
Ivory	IFP11EI	IFP12EI	IFP13EI	IFP14EI	IFP16EI	IFP26EI	IFP29EI	IFP212EI
Light Almond*	IFP11LA	IFP12LA	IFP13LA	IFP14LA	IFP16LA	IFP26LA	IFP29LA	IFP212LA
Office White	IFP11OW	IFP12OW	IFP13OW	IFP14OW	IFP16OW	IFP26OW	IFP29OW	IFP212OW
White	IFP11W	IFP12W	IFP13W	IFP14W	IFP16W	IFP26W	IFP29W	IFP212W

Note: *Light Almond plates match Office White non-metallic raceway, boxes, jacks and connectors.

Stainless Steel Face Plates without Label Fields, 1- and 2-Gang

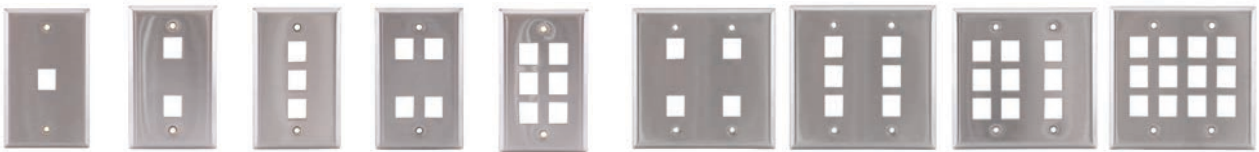

Catalog No.	1-Gang					2-Gang			
	1-Port	2-Port	3-Port	4-Port	6-Port	4-Port	6-Port	9-Port	12-Port
	SSF11	SSF12	SSF13	SSF14	SSF16	SSF204	SSF206	SSF209	SSF212

Stainless Steel Face Plates with Label Fields

1-Gang	Catalog Number
1-Port	SSFL11
2-Port	SSFL12
3-Port	SSFL13
4-Port	SSFL14
6-Port	SSFL16

Duplex and Decorator Plates with Label Fields

	Color	Duplex Plate	Decorator Plate
	Almond	IFP18AL	IFP126AL
	Office White	IFP18OW	IFP126OW

Standard Duplex and Decorator Plates with No Label Fields, 1- and 2-Gang

	Color	1-Gang Duplex Plate	1-Gang Decorator Plate	2-Gang Decorator Plate
	Almond	NP8AL	NP26AL	NP262AL
	Black	NP8BK	NP26BK	NP262BK
	Ivory	NP8I	NP26I	NP262I
	Gray	NP8GY	NP26GY	NP262GY
	Light Almond*	NP8LA	NP26LA	NP262LA
	White	NP8W	NP26W	NP262W

Note: *Light Almond plates match Office White non-metallic raceway, boxes, jacks and connectors.

630 Wall Phone Plates, 1-Gang

Stainless Steel, 1-Gang wall phone plate.



P630S1GJ6 **P630SR1GJ6**

Jack Format	Includes Gray Jack	Catalog Number
Flush	6-position USOC, RJ25	P630S1GJ6
Flush	8-position Cat. 5e, RJ45	P630S1GJ8
Recessed	6-position USOC, RJ25	P630SR1GJ6
Recessed	8-position Cat. 5e, RJ45	P630SR1GJ8

Keystone Opening
 Hole size for mounting
 all Hubbell Jacks.

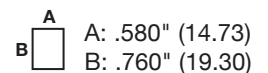



HDMI** Decorator Frames



Color	1-Port	2-Port
Black	NS801BK	NS802BK
Gray	NS801GY	NS802GY
Ivory	NS801I	NS802I
Light Almond	NS801LA	NS802LA
White	NS801W	NS802W

Note: **HDMI (High Definition Media Interface).

Blank Duplex Outlet Frames, 1-Gang



Color	Keystone 2-Port	Keystone 4-Port
Almond	BR106AL	Q106AL
Black	BR106B	Q106B
Gray	BR106G	Q106G
Ivory	BR106E	Q106E
Light Almond*	BR106LA	Q106LA
Office White	BR106C	Q106O
White	BR106W	Q106W

Note: *Light Almond frames match Office White non-metallic raceway, boxes, jacks and connectors.

Blank Decorator Outlet Frames, 1-Gang



Color	Keystone 2-Port	Keystone 3-Port	Keystone 4-Port	Keystone 6-Port	HD15/9 or HDMI	(2) HD15/9 or HDMI	(1) Recessed HD15/9 or HDMI	.406 in. (10.3) hole	Blank
Almond	ISF2AL	ISF3AL	ISF4AL	ISF6AL	ISFB15AL	—	—	NS621AL	NS620AL
Black	ISF2BK	ISF3BK	ISF4BK	ISF6BK	ISFB15BK	ISFB215BK	ISFBR15BK	—	—
Gray	ISF2GY	ISF3GY	ISF4GY	ISF6GY	ISFB15GY	ISFB215GY	ISFBR15GY	—	—
Ivory	ISF2EI	ISF3EI	ISF4EI	ISF6EI	ISFB15EI	ISFB215EI	ISFBR15EI	NS621I	NS620I
Light Almond*	—	—	—	—	ISFB15LA	—	—	NS621LA	NS620LA
Office White	ISF2OW	ISF3OW	ISF4OW	ISF6OW	ISFB15OW	ISFB215OW	ISFBR15OW	—	—
White	ISF2W	ISF3W	ISF4W	ISF6W	ISFB15W	ISFB215W	ISFBR15W	NS621W	NS620W

Note: *Light Almond frames match Office White non-metallic raceway, boxes, jacks and connectors.

Secure-IT Plates



Secure-IT Plates protect mated and unmated connections from physical damage and unauthorized tampering. Available in Tamper-Resistant and Weatherproof versions.



TPF1W

Tamper-Resistant Plates

Color	1-Gang/4-Port Catalog Number
Black	TPF1BK
Gray	TPF1GY
Office White	TPF1OW
White	TPF1W



TWPF1GY

NEMA 3R Weatherproof Plates

Color	1-Gang/4-Port Catalog Number
Gray	TWPF1GY

HDMI Connectors



HDMI Feed Thru Coupler

Description	Catalog Number
Single	HDMIC14



Keystone HDMI Feed Thru

Description	Color	Catalog Number
Single	Black	SFHC14BK
Single	White	SFHC14W



HDMI Feed Thru 3-Inch Tail

Description	Catalog Number
Single	HDMIT14

DVI Adapters/Couplers



DVI-I Coupler

Description	Catalog Number
Single	DVI1



DVI to VGA Adapter

Description	Catalog Number
Single	DVI151



DVI to HDMI Adapter

Description	Catalog Number
Single	DVIHDMI1



DVI to HDMI Adapter

Description	Catalog Number
Single	HDMIC1

110 Audio Video Modules*

Description	Housing Color	Catalog Number
RCA Component, Video to 110 Termination, 1 Unit, 75 ft. max. HD Cat 5, 5e, 6 UTP	Almond Black Ivory Gray Office White White	IMCR1101AL IMCR1101BK IMCR1101EI IMCR1101GY IMCR1101OW IMCR1101W
S-Video, Stereo RCA Audio to 110 Termination, 1 Unit, 100 ft. max. Cat 5, 5e, 6 UTP	Almond Black Ivory Gray Office White White	IMSR1101AL IMSR1101BK IMSR1101EI IMSR1101GY IMSR1101OW IMSR1101W
S-Video, 3.5mm Stereo Jack to 110 Termination, 1 Unit, 100 ft. max. Cat 5, 5e, 6	Almond Black Ivory Gray Office White White	IMSV351101AL IMSV351101BK IMSV351101EI IMSV351101GY IMSV351101OW IMSV351101W
RCA Composite, Video, Stereo Audio to 110 Termination, 1 Unit, 100 ft. max. Cat 5, 5e, 6	Almond Black Ivory Gray Office White White	IMR1101AL IMR1101BK IMR1101EI IMR1101GY IMR1101OW IMR1101W
Stereo RCA, Audio 110 Termination, 1 Unit, 100 ft. max. Cat 5, 5e, 6	Almond Black Ivory Gray Office White White	IMAR1101AL IMAR1101BK IMAR1101EI IMAR1101GY IMAR1101OW IMAR1101W



IMCR1101W



IMSR1101W



IMSV351101W



IMR1101W



IMAR1101W

Note: *Not UL Listed.



IMCRS15OW



IMCRS10W



IM3RS10W



IMRSJ10W



IMCRF10W



IM3RF10W



IMSP10W



SPPBK10

SPPR10

110 Audio Video Modules

Description	Housing Color	Catalog Number
RCA Component Video,* Audio 110 Termination, 1.5 Unit	Almond	IMCRS15AL
	Black	IMCRS15BK
	Ivory	IMCRS15EI
	Gray	IMCRS15GY
	Office White	IMCRS15OW
	White	IMCRS15W
RCA Component* Video, Solder, 1 Unit	Almond	IMCRS1AL
	Black	IMCRS1BK
	Ivory	IMCRS1EI
	Gray	IMCRS1GY
	Office White	IMCRS10W
	White	IMCRS1W
RCA Composite, Video Audio, Solder, 1 Unit	Almond	IM3RS1AL
	Black	IM3RS1BK
	Ivory	IM3RS1EI
	Gray	IM3RS1GY
	Office White	IM3RS10W
	White	IM3RS1W
RCA Composite, Video, 3.5mm Stereo Jack, Solder, 1 Unit	Almond	IMRSJ1AL
	Black	IMRSJ1BK
	Ivory	IMRSJ1EI
	Gray	IMRSJ1GY
	Office White	IMRSJ10W
	White	IMRSJ1W

Gold Feed-Through Audio Video RCA Couplers

Description	Housing Color	Catalog Number
RCA Component* Video, Gold, Pass-Through, F/F Coupler, 1 Unit	Almond	IMCRF1AL
	Black	IMCRF1BK
	Ivory	IMCRF1EI
	Gray	IMCRF1GY
	Office White	IMCRF10W
	White	IMCRF1W
RCA Composite, Video Audio, Gold, Pass-Through, F/F Coupler, 1 Unit	Almond	IM3RF1AL
	Black	IM3RF1BK
	Ivory	IM3RF1EI
	Gray	IM3RF1GY
	Office White	IM3RF10W
	White	IM3RF1W

Gold Speaker Posts and Banana Plugs

Description	Housing Color	Catalog Number
Speaker Post, Gold, Black and Red, Screw Termination	Almond	IMSP1AL
	Black	IMSP1BK
	Ivory	IMSP1EI
	Gray	IMSP1GY
	Office White	IMSP10W
	White	IMSP1W
Speaker Banana Plugs*, Gold, Screw Termination, 10-Packs	Black	SPPBK10
	Red	SPPR10

Note: *Not UL Listed.



Modular Face Plate Frames

Color	1-Gang	2-Gang
Almond	IMF1AL	IMF2AL
Black	IMF1BK	IMF2BK
Gray	IMF1GY	IMF2GY
Ivory	IMF1EI	IMF2EI
Office White	IMF1OW	IMF2OW
White	IMF1W	IMF2W

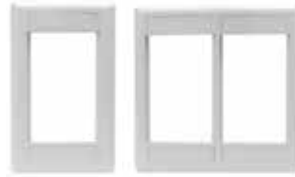

Raceway Bezel Frames*

Color	1-Gang
Almond	KPIMBZAL
Gray	KPIMBZGY
Office White	KPIMBZOW



Unloaded Keystone Modules

Color	1-Port, Flat 1 Unit	2-Port, Flat 1 Unit	1-Port, Angled 1.5 Unit	2-Port, Angled 1.5 Unit	Recessed Angle 1-Port, 1.5 Unit	Recessed Angle 2-Port, 1.5 Unit
Almond	IM1K1AL	IM2K1AL	IM1KA15AL	IM2KA15AL	-	-
Black	IM1K1BK	IM2K1BK	IM1KA15BK	IM2KA15BK	IM1IA15BK	IM2IA15BK
Ivory	IM1K1EI	IM2K1EI	IM1KA15EI	IM2KA15EI	IM1IA15EI	IM2IA15EI
Gray	IM1K1GY	IM2K1GY	IM1KA15GY	IM2KA15GY	IM1IA15GY	IM2IA15GY
Office White	IM1K1OW	IM2K1OW	IM1KA15OW	IM2KA15OW	IM1IA15OW	IM2IA15OW
White	IM1K1W	IM2K1W	IM1KA15W	IM2KA15W	IM1IA15W	IM2IA15W

Color	Blank 0.5 Unit	Blank 1 Unit	Blank 1.5 Unit	SC Angled 1-Port, 1.5 Unit	SC Angled 2-Port, 1.5 Unit
Almond	IMB05AL	IMB1AL	IMB15AL	-	-
Black	IMB05BK	IMB1BK	IMB15BK	IM1SCA15BK	IM2SCA2BK
Ivory	IMB05EI	IMB1EI	IMB15EI	IM1SCA15EI	IM2SCA2EI
Gray	IMB05GY	IMB1GY	IMB15GY	IM1SCA15GY	IM2SCA2GY
Office White	IMB05OW	IMB1OW	IMB15OW	IM1SCA15OW	IM2SCA2OW
White	IMB05W	IMB1W	IMB15W	IM1SCA15W	IM2SCA2W

HD (High Definition) 15-Pin/9-Pin Modules

	Blank HD15/9 or HDMI Module, 1 Unit	IMBDS1xx	10-Pack
	Blank HD15/9 or HDMI Module, 1.5 Unit	IMBDSA15xx	1-Pack

DVI Modules

	DVI Blank, Unloaded, 1.5 Unit	IMBDVI15xx	1-Pack
		IMBDVI1015xx	10-Pack

Note: xx = Color: **AL** (Almond), **BK** (Black), **EI** (Ivory), **GY** (Gray), **LA** (Light Almond), **OW** (Office White), and **W** (White).

Hubbell iSTATION Audio/Video Modules

XLR, speakON® and ¼ inch modules applications include video distribution, desktop and laptop computers, monitors, cameras, microphones and projectors, home theater and entertainment. Note: Order IMAVB15 series blank modules with AV connectors for Hubbell iSTATION applications.

	AV Blank 1.5 Unit	IMAVB15xx*	10-Pack
	XLR Screw Terminal	XLRST10	
	XLR Solder-Type	XLR10	
	speakON® Conn. Solder-Type	SC10	
	USB Feed-Thru A-to-B	USB10	
	¼" Stereo Jack Solder-Type	14S10	

Note: xx = Color: **AL** (Almond), **BK** (Black), **EI** (Ivory), **GY** (Gray), **LA** (Light Almond), **OW** (Office White), and **W** (White).

*Not UL Listed.

speakON® is a registered trademark of Neutrik® AG.



Specifications

- Low-profile design.
- Accepts XJ jacks, audio video and fiber connectors.
- Provided with double-sided tape and mounting screws for easy installation.
- UL and cUL listed.
- Constructed with a high-impact resistant, flame-retardant polymer.
- ANSI/TIA-606B compliant.

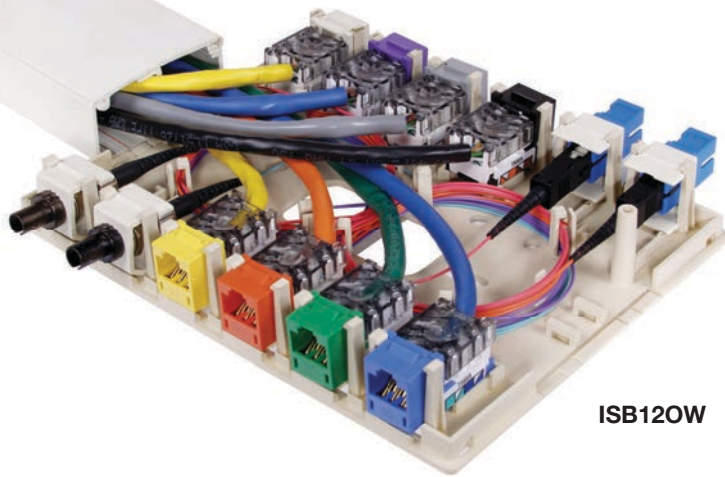

ISB120W



ISB10W



ISB20W



ISB40W



ISB60W



ISB120W

ISB Surface Mount Boxes, 1- and 2-Port

Ideal for open office, compact surface mount environments, and retrofits to support data, voice, and multimedia applications. Can be mounted with supplied surface mounting screws or double-sided adhesive tape.

Color	1-Port Catalog Number	2-Port Catalog Number
Ivory	ISB1EI	ISB2EI
Office White	ISB10W	ISB20W
White	ISB1W	ISB2W

ISB Surface Mount Boxes, 4- and 6-Port

Ideal for open office MUTOA cabling, compact surface mount environments, and retrofits to support data, voice, and multimedia applications. Features adjustable furniture latches to provide an additional mounting option to common ANSI/TIA/EIA standard furniture openings, and solutions requiring fiber. Box bases feature fiber storage posts that can store one meter fiber cable after termination.

Color	4-Port Catalog Number	6-Port Catalog Number
Ivory	ISB4EI	ISB6EI
Office White	ISB40W	ISB60W
White	ISB4W	ISB6W

ISB Surface Mount Boxes, 12-Port

Ideal for open office MUTOA cabling, large capacity surface mount applications and retrofits to support data, voice, and multimedia installations. Can be mounted with supplied surface mounting screws or double-sided adhesive tape and mounted to NEMA electric boxes or relay racks.

Color	12-Port Catalog Number
Ivory	ISB12EI
Office White	ISB120W
White	ISB12W

Consolidation Point Block, Category 6 and Category 5e

Description	Catalog Number
Category 6, 12-Port, Universal, 89D	P612U
Category 5e, 12-Port, Universal, 89D	P5E12U



P612U

P5E12U

Universal Patch Panel, Category 5e

Description	Catalog Number
24-Port, 1.75" H	P5E24UE
48-Port, 3.50" H	P5E48UE
96-Port, 7.0" H	P5E96UE



P5E24UE

Universal Patch Panel, Category 6

Description	Catalog Number
24-Port, 1.75" H	P6E24U
48-Port, 3.50" H	P6E48U
96-Port, 7.0" H	P6E96U



P6E48U

Keystone Jack Panel, Unloaded*

Description	Catalog Number
Wall Mount, 12-Port, Black	UDX1289
Rack Mount, 24-Port, 1.75" H, Black	UDX24E
Rack Mount, 48-Port, 3.5" H, Black	UDX48E

Note: *Not UL Listed.



UDX24E

Rear Cable Management Bar*

Description	Catalog Number
Screws to the rear flange of a 19-inch rack	CMBR

Note: *Not UL Listed.



CMBR



Horizontal UTP Cable and Patch Cords

- Solid copper 4-pair 24 or better AWG UTP is specified for distribution cabling. Stranded UTP is specified for patch cords for flexibility. Shielded cable is not commonly used in the U.S. splices and bridge taps are not permitted.
- Cable, connectors and patch cords shall be marked with the performance category. Always match performance categories of cables and components throughout the infrastructure.
- All cable, cords and connecting hardware shall meet performance requirements of ANSI/TIA/EIA-568-C.1 and 568-C.2. Hubbell assures this compliance with all products and cable partners.

COLOR CODING:



Recognized Connector and Wiring Configurations

- 8-position modular jack/plug.
- 8-position modular panel/plug.
- T568A wiring or T568B wiring options.
- Cat. 5e or Cat. 6 recommended.

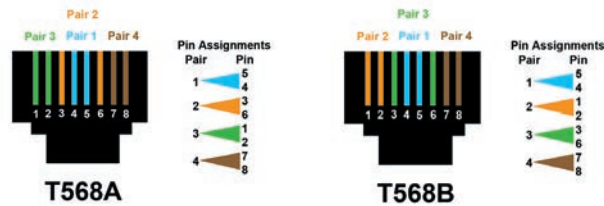

RJ45 - TIA-568 Conventions

Two wiring standards were adopted. Both configurations provide equivalent transmission performance.



- Preferred method
- Directly compatible with 2-pair voice and Token Ring systems utilizing 6-position connectors



- Optional method
- AT&T's standard
- Directly compatible with AT&T phone systems

LAN Wiring Conventions

Local Area Network standards designed to operate over UTP specify pin/pair assignments on modular connectors for various signal transmission protocols. While TIA/EIA-568A and 568B conventions support all of these designations, there are some cases where the user chooses to cable only the number of pairs required to support these applications.

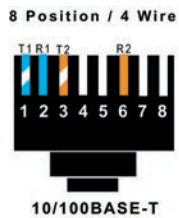

- 10 Mbps Ethernet over UTP
- 100 Mbps Ethernet



- 4/16 Mbps Token Ring over copper



- 100 Mbps FDDI over copper (pending)

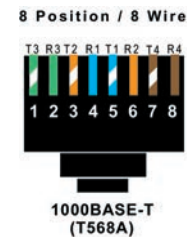

- 1000 Mbps/10Gb Ethernet over UTP
- Uses all four pairs



Index

netSELECT® Products	Page
Structured Wiring	
In-Wall AV Delivery	W-14
HDMI Products	W-15
Advantages and Wiring Layout	W-16
Network Enclosures	W-17
Network Modules	W-18
Audio/Video Modules	W-19
Universal Consolidation Blocks, Patch Panels and Patch Cords	W-20
Accessories	W-21
Data Communications and Audio/Video	
Modular Snap Fit Jacks	W-22
Decorator Frames	W-23
Molded-In Voice/Data/Video	W-24
Molded-In Plates	W-25
Telephone Wall Jacks	W-26

In-Wall AV Delivery and HDMI Products

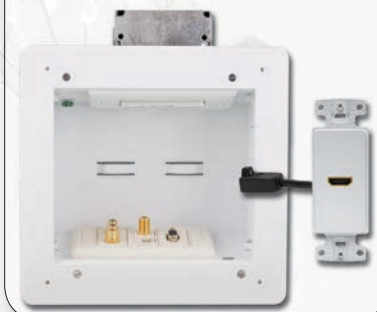

Universal Blocks, Patch Panels and Cords

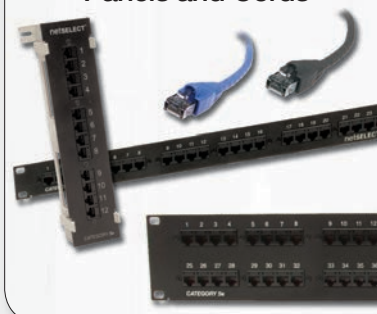

Modular Snap Fit Jacks



Molded-In Voice/Data/Video

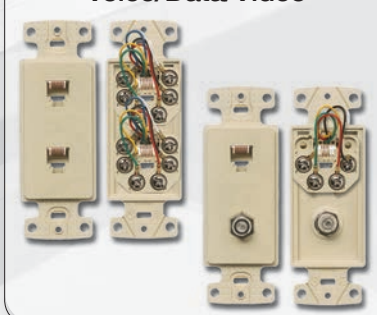



Hubbell's netSELECT® Flat Panel Television (FPTV) connection enclosure delivers high-density connectivity and power in the wall. This allows flat panel displays and interactive "smart" boards to sit flush against walls with no dangling cords. It quickly installs to studs or sheetrock without additional components or hardware.

- 18 Gauge white powder coated rugged steel base
- 2-Gang enclosure with two 1½ and 1¼ inch KOs
- Stud or sheetrock mounting integrated
- Supplied ABS trim ring quickly cleans up sheetrock rough-in
- Optional screw on cover reduces tampering
- cULus 1863 Listed

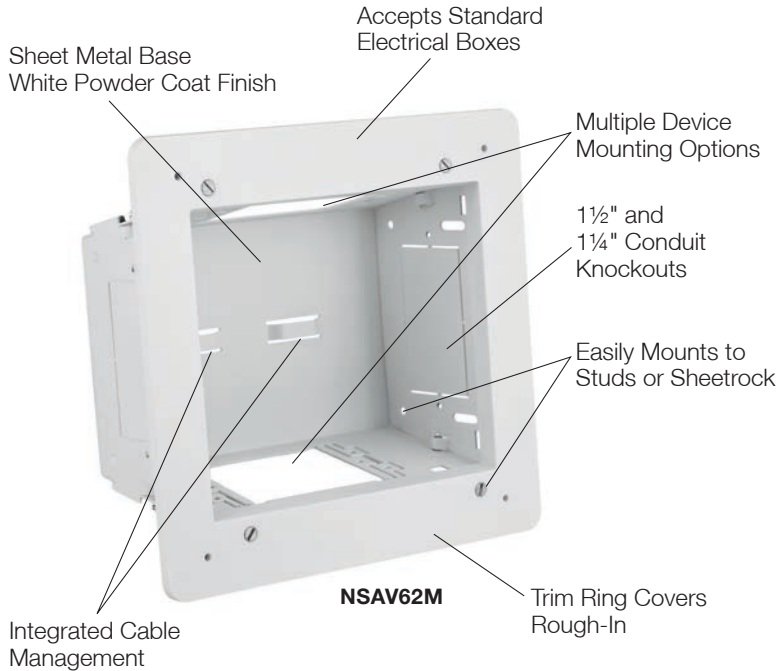

FPTV Connection Enclosure

Description	Color	Catalog Number
2-Gang In-Wall Enclosure	White	NSAV62M
Steel Cover with Cable Exit	White	NSAV6C
Blank Steel Cover	White	NSAV6CB
Block Wall Adaptor	White	NSAV6BW
New Work Stud Bracket	White	NSAV6NW

Accessories

Power Kits

Description	Color	Catalog Number
Standard Power Kit	White	NSOKPTR
Surge Protected Power Kit	Blue	NSOKPS

Unloaded Plates and Frames

1-Gang Blank Plate	White	NP14W
1-Gang Decorator Plate	White	NP26W
1-Gang Hubbell iSTATION Plate	White	IMF1W
1-Gang 4-Port Keystone Plate	White	NSP14W

AV Connectors and Plates

1-Port HDMI Frame	White	NS801W
2-Port HDMI Frame	White	NS802W
HDMI Snap Fit	White	SFHC14W
F-Connector Snap Fit	White	NSF70W
USB A-to-B Snap Fit	White	SFUSBABW
Cat 6 Snap Fit Jack	White	NSJ6W

Note: See page W-22 for snap fit multimedia jacks and AV connectors.



The AV Ceiling Enclosure is designed to work with active AV devices to integrate AV distribution, data connections and power in one location, providing a direct connection to a projector or a display device. An additional AV/data kit can be added or customized to address all connector, mounting and patching needs, reducing multiple pieces on site.

- Manage multiple applications inside one enclosure
- Flush mounted, white enclosure for consistent look when mounted in the ceiling
- Loaded with two Hubbell 20A duplex receptacles and a 2-gang back box
- All steel rugged construction provides the ultimate strength for installation



AVCE1H

AV Ceiling Enclosure

Description	Height Inches (mm)	Width Inches (mm)	Depth Inches (mm)	Color	Catalog Number
AV Ceiling Enclosure	12" (305)	24" (610)	8" (203)	White	AVCE1H

Note: Enclosure includes two 20 amp duplex receptacles and 2-gang back box.

netSELECT® HDMI Decorator Frames deliver uncompromising digital audio and video wherever you need it. Unleash the full potential of your high definition display and audio installations.

- Third party tested for 1080p resolutions
- UL Listed - Communications Circuit Accessory and CSA Certified

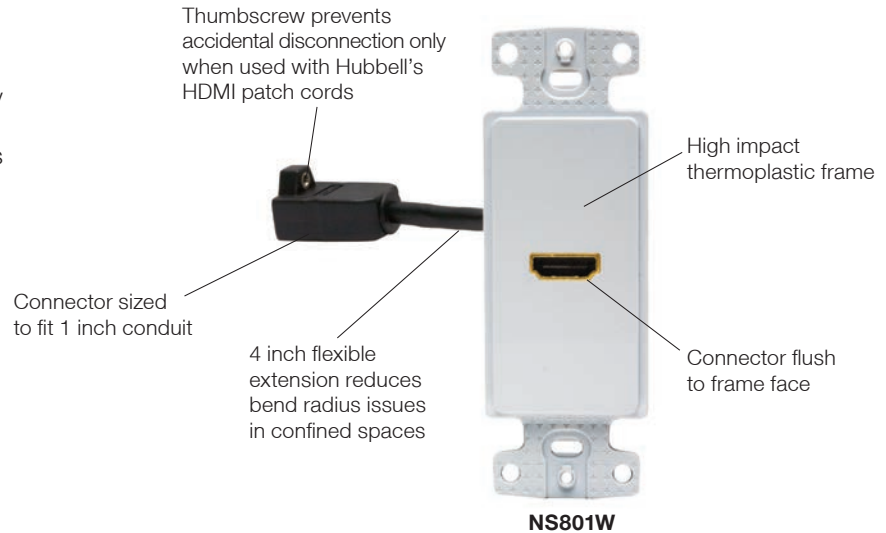

NS801W

HDMI Products

Description	Color	1-Gang, 1-Port	1-Gang, 2-Port
HDMI, Decorator Frame, Female to Female	Black	NS801BK	NS802BK
	Gray	NS801GY	NS802GY
	Ivory	NS801I	NS802I
	Light Almond	NS801LA	NS802LA
	Office White	NS801OW	NS802OW
	White	NS801W	NS802W



HDMI Patch Cords, 24 AWG

Length	HDMI Device Patch Cords	Length	Horizontal Cords (Connector to Connector)	Length	Link Cords (Connector to Device)	Length	Coupler Cords (Coupler to Device)
3 ft.	HDPC03BK	10 to 30 ft.	HDHyyBK	10 to 30 ft.	HDLyyBK	10 to 30 ft.	HDCyyBK
6 ft.	HDPC06BK						

Note: yy = Length in feet. 10 (10'), 15 (15'), 20 (20'), 25 (25'), 30 (30'). Black and non-plenum only. Black and Non-Plenum only.



Connect Your Home to Internet, Voice and Video Services

netSELECT® is an innovative network solution that's perfect for any home or small office. Specifically positioned as the voice/data segment for the Residential brand, the netSELECT® System satisfies the need for a dependable, flexible system that can accommodate all of today's fast-changing voice, data and video requirements.

This cost-effective solution incorporates all the quality you'd expect from Hubbell. Built-in flexibility makes it easy to upgrade and keep pace with evolving technologies.

- Share single analog, cable or DSL internet connection
- Local file access
- Shared peripherals
- Multiple telephone distribution
- Call handling (PBX)
- Video distribution
- Play games that allow multi-users
- Control home automation systems

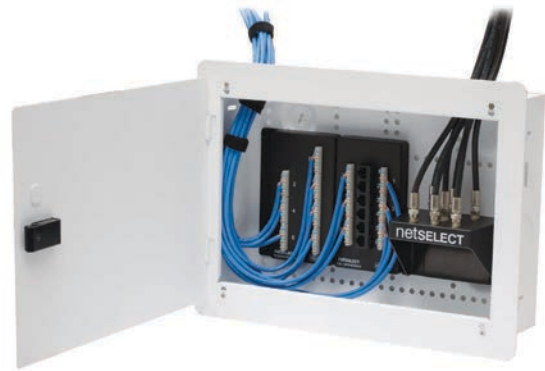

Today's Communications Entail A Lot More Than Just Talking. netSELECT® Keeps You Connected—Internet, Voice, Data and Entertainment

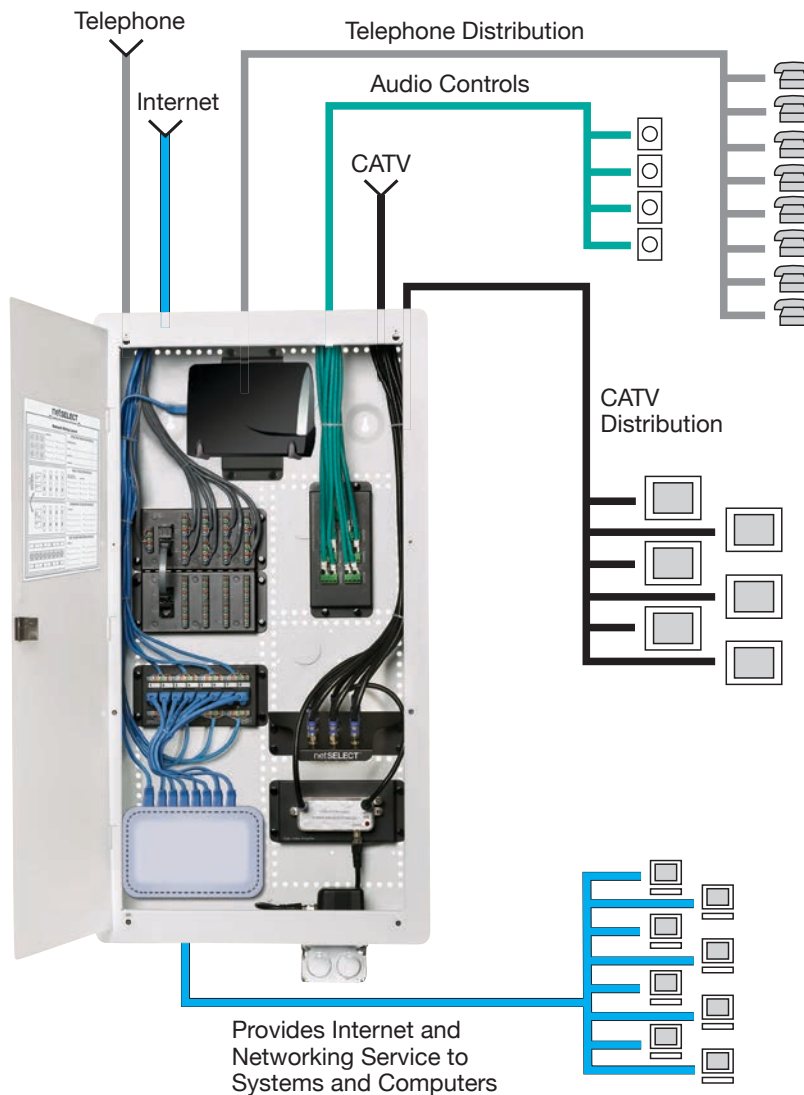

- Flush or surface mount enclosure (hardware provided)
- Hinged cover can be mounted to swing from either side
- Integral trim ring hides rough-in hole in sheet rock providing a finished appearance (except NSOBOX48)
- Horizontal and vertical module mounting holes for maximum flexibility
- Unique 89D bracket mounting holes allow easy mounting of 66 blocks and peripherals
- Provisions to mount optional duplex power and lock kit available
- Integral cable management slots and tie-wraps provided to help dress cable runs
- Additional nylon push pins provided to assist module mounting
- Material: 20-18 gauge steel
- Finish: white, powder coat
- UL and cULus Listed 1863

Network Enclosures

Pre-Configured Network System

Description	No. of Module Placement	Catalog Number
Pre-Configured Network System	–	NSOBNK14
Basic home network kit includes:		
One box with hinged cover NSOBOX14,		
One primary 8-port telephone module NSOPTM8,		
One four way coaxial splitter module NSOVM4		



NSOBOX10

10 Inch Network Enclosure for MDU and Modular Applications

Description	Height Inches (mm)	Width Inches (mm)	Depth Inches (mm)	No. of Module Placement	Catalog Number
With Hinged Cover	11.55" (293)	15.65" (398)	4.08" (104)	3	NSOBOX10
With Panel Cover	11.07" (281)	–	4.08" (104)	3	NSOBOX10BC
10"H Box only	10.07" (256)	14.38" (365)	3.96" (101)	3	NSOBOX10B
Hinged Door	11.55" (293)	15.65" (398)	0.58" (15)	–	NSOBOX10D
Panel Cover	11.07" (281)	15.50" (594)	0.20" (5)	–	NSOBOX10C



NSOBOX14

14 Inch Network Enclosure

With Hinged Cover	15.55" (395)	15.65" (398)	4.08" (104)	5	NSOBOX14
With Panel Cover	15.10" (384)	15.54" (395)	4.08" (104)	5	NSOBOX14BC
14"H Box only	14.00" (356)	14.38" (365)	3.96" (101)	5	NSOBOX14B
Hinged Door	15.55" (395)	15.65" (398)	0.33" (8)	–	NSOBOX14D
Vented Door (Louver)	15.55" (395)	15.65" (398)	0.52" (15)	–	NSOBOX14DL
Panel Cover	15.11" (384)	15.54" (395)	0.20" (5)	–	NSOBOX14C
2"D Extension Bracket with ventilation and WiFi KOs	15.30" (389)	15.57" (395)	2.00" (51)	–	NSOBOX14X2

28 Inch Network Enclosure

With Hinged Cover	29.55" (751)	–	–	11	NSOBOX28
With Panel Cover	29.13" (740)	15.54" (395)	4.08" (104)	11	NSOBOX28BC
28"H Box only	28.00" (711)	14.38" (365)	3.96" (101)	11	NSOBOX28B
Hinged Door	29.55" (751)	15.65" (398)	0.33" (8)	–	NSOBOX28D
Vented Door* (Louver)	29.55" (751)	15.65" (398)	0.52" (15)	–	NSOBOX28DL
Panel Cover	29.29" (744)	15.54" (395)	0.20" (5)	–	NSOBOX28C
2"D Extension Bracket with ventilation and WiFi KOs	29.3" (744)	15.57" (395)	2.00" (51)	–	NSOBOX28X2



NSOBOX28

48 Inch Network Enclosure

With Hinged Cover	48.94" (1243)	14.94" (379)	4.07" (103)	21	NSOBOX48*
-------------------	---------------	--------------	-------------	----	------------------

Note: *Door covers rough-in, no trim ring provided.



netSELECT® Modular Components enable the designer to select performance requirements specifically for the application. Modules snap horizontally or vertically into the enclosures for maximum flexibility and optimum space usage.

- Dimensions: 6.47 in. W x 2.95 in. H, except NSOMTM24 6.47 in. W x 6.00 in. H
- Meets FCC Part 68 standard
- Material: High impact plastic
- UL and cULus Listed 1863
- All data and phone modules 568A wired

Network Modules

Description	Units	Catalog Number
<p>Combo Module</p> <p>Complete Home Network Combo Module 6-Port Telephone Panel and 6-Port Coaxial Splitter with Optional 6-Port Cat. 5e Panel Provides voice, video, and data distribution in a space efficient package. Perfect for use with NSOBOX10 and NS790xx plates to quickly establish a comprehensive home network.</p>		
<p>6-Port Telephone and Video</p> <p>6-Port Telephone, Video and Category 5e</p> <p>6-Port Category 5e Data Upgrade Kit</p>	3	NSOTVM6
	3	NSOTVDM6
	3	NSODK6
<p>Primary Telephone Module, 8-Port</p> <p>Supports 8 phone outlets with up to 4 incoming lines for voice, fax or modem applications in a protected PCB module. Pre-mounted push pins snap the module quickly into place. RJ31X interface jack included for security system connection. RJ45 jack interfaces with optional NSOETM8 Telephone Expansion module for additional extensions.</p>	1	NSOPTM8
<p>Expansion Telephone Module, 8-Port</p> <p>Adds an additional 8 phone outlets with up to 4 incoming lines when used with the primary telephone module. Pre-mounted push pins snap the module quickly into place. Includes RJ45 jumper cord to connect with NSOPTM8 Primary Telephone module.</p>	1	NSOETM8
<p>Category 5e Data Module, 8-Port</p> <p>Supports Gigabit Ethernet for up to 8 Category 5e data lines with front 110 Punch-Down terminations in a protected PCB module. Pre-mounted push pins snap the module quickly into place.</p>	1	NSODM8
<p>Category 6 Data Module, 8-Port</p> <p>Supports enhanced transmission speeds beyond gigabit ethernet. Future proof for tomorrows applications.</p>	1	NSODM8C6
<p>Multiport Patchable Telecom Module</p> <p>Terminates lines via modular plug to accommodate flexibility, by changing plug locations. Reconfigure where phone lines go at the panel level. Allows data lines to be converted to voice, with the move of a patch cord. Includes nine RJ45 jumper cords.</p>	2	NSOMTM24
<p>Combination Module</p> <p>6-Port Telephone and 1-Port Data</p> <p>Provides basic telephone and data delivery in a small package. Allows data lines to be converted to voice, with the move of a patch cord.</p>	1	NSO6P1DM



NSOTVDM6



NSOPTM8



NSOETM8



NSODM8



NSOMTM24



NSO6P1DM

netSELECT® Video Modules support bidirectional signal by splitting to 4, 6, or 8 separate work areas. Pre-mounted push pins snap the module quickly into place.

- Dimensions for VAMP, AM8 and BM: 6.47 in. W x 2.95 in. H
- Dimensions for video splitters: 6.47 in. W x 2.09 in. H x 3.20 in. D
- Material: High impact plastic
- UL and cULus Listed 1863

Audio/Video Modules

Description	Units	Catalog Number
4-Way Coaxial Splitter Modules, One Incoming Line, Four Outgoing 1 Ghz, Basic Unit 2.3 Ghz, Enhanced Capability	1 1	NSOVM4 NSOVM42G
6-Way Coaxial Splitter Modules, One Incoming Line, Six Outgoing 1 Ghz, Basic Unit 2.3 Ghz, Enhanced Capability	1 1	NSOVM6 NSOVM62G
8-Way Coaxial Splitter Modules, One Incoming Line, Eight Outgoing 1 Ghz, Basic Unit 2.3 Ghz, Enhanced Capability	1 1	NSOVM8 NSOVM82G
Fixed Video Amplifier Module, 10dB 120 volt rated	1	NSOVAMP
Provides video signal amplification for incoming cable feeds recommended for use when more than four outputs are installed or when signal level is low. Provides 10dB forward path gain and supports current digital cable systems and modems with a passive return. Pre-mounted push pins snap the module quickly into place. Includes RG-59 cable jumper to connect amplifier to passive video splitter.		
8 Room Audio Module, Distributes audio from an amplifier to matching volume controllers. Supports up to eight rooms of audio. Power handling - 200W RMS@20° C. Requires impedance matching volume controls, see page W-21.	1	NSOAM8
Blank Module Plate Allows mounting of active components (i.e. switches, routers) or other devices (66 blocks, audio components) onto a modular platform. Can be custom drilled or used with two self-adhesive VELCRO® strips included to mount components onto module. Pre-mounted push pins snap the module quickly into place.	1	NSOBM



NSOVM4



NSOVM6



NSOVM8



NSOVAMP



NSOAM8



NSOBM

VELCRO® is a registered trademark of Velcro Industries B.V.



netSELECT® Patch Panels are excellent for designing rack systems for telephone, data and AV systems. Consolidation Blocks are ideal for small user count configurations that mount in or on the wall.

- Meets ANSI/TIA - Category 6 and Category 5e standards
- cULus Listed

Universal Consolidation Blocks and Patch Panels

Description	Catalog Number
Category 5e 12-Port Universal Consolidation Block, 89D Bracket Mount	NS5E12U
Category 6 12-Port Universal Consolidation Block, 89D Bracket Mount	NS612U
Category 5e Universal Patch Panel 24-port, 1.75 inch H, 1 Rack Unit 48-port, 3.50 inch H, 2 Rack Units	NS5E24U NS5E48U
Category 6 Universal Patch Panel 24-port, 1.75 inch H, 1 Rack Unit 48-port, 3.50 inch H, 2 Rack Units	NS624U NS648U



NS5E12U



NS612U



NS5E24U



NS5E48U



NS624U



NS648U

netSELECT® Patch Cords allow for quick change of voice/data lines with insertion of modular plugs.

- Meets and exceeds ANSI/TIA - Category 6 and Category 5e standards
- UL and cUL Listed

Universal Patch Cords, Category 6 and Category 5e

Description	Color	1-Foot	3-Foot	5-Foot	7-Foot	10-Foot	15-Foot	20-Foot	25-Foot
Cat. 5e Patch Cord	Blue	HC5EB01	HC5EB03	HC5EB05	HC5EB07	HC5EB10	HC5EB15	HC5EB20	HC5EB25
	Gray	HC5EGY01	HC5EGY03	HC5EGY05	HC5EGY07	HC5EGY10	HC5EGY15	HC5EGY20	HC5EGY25
	Yellow	HC5EY01	HC5EY03	HC5EY05	HC5EY07	HC5EY10	HC5EY15	HC5EY20	HC5EY25
	Red	HC5ER01	HC5ER03	HC5ER05	HC5ER07	HC5ER10	HC5ER15	HC5ER20	HC5ER25
Cat. 6 Patch Cord	Blue	HC6B01	HC6B03	HC6B05	HC6B07	HC6B10	HC6B15	HC6B20	HC6B25
	Gray	HC6GY01	HC6GY03	HC6GY05	HC6GY07	HC6GY10	HC6GY15	HC6GY20	HC6GY25
	Yellow	HC6Y01	HC6Y03	HC6Y05	HC6Y07	HC6Y10	HC6Y15	HC6Y20	HC6Y25
	Red	HC6R01	HC6R03	HC6R05	HC6R07	HC6R10	HC6R15	HC6R20	HC6R25



netSELECT® Accessories enhance system capabilities. Volume controls expand home audio applications. Cabinet mounted receptacle kits provide convenience power to the enclosure.

- Audio controls available in slide or rotary
- Receptacles available in surge and standard kits

Accessories

Description	Color	Catalog Number
Slide Audio Volume Controller, Decorator Styling, Power handling - 70W RMS@20° C. Impedance matching for up to 8 pairs of speakers. Includes both ivory and white slides and frames.	Ivory/White	NSOSAVC
Rotary Audio Volume Controller Power handling - 70W RMS@20° C. Impedance matching for up to 8 pairs of speakers. Includes both ivory and white knobs and frames.	Ivory/White	NSORAVC
Standard Power Kit, Includes tamper-resistant duplex receptacle 15A 125V NEMA 5-15R, electrical steel box and wallplate.		NSOKPTR
Surge Suppression Power Kit, Includes surge receptacle 15A 125V NEMA 5-15R, 240 Joules/15,000A protection per mode, electrical steel box and wallplate.		NSOKPS
Chromed Steel Lock Kit, Includes two keys. Eliminates unwanted tampering.		FLOCK1
Panel Bracket Adapter, For use with Adapter Panels shown below, and FSP series modules. Snap mounts into structured cabling enclosures.		NSOFSB
F-Connector Adapter Panel, with Six Populated Coaxial Connectors.		FSPFP6X
Keystone Adapter Panel, with Six Blank Openings for jacks and snap fits.		FSPHD6X
WiFi Antenna Kit, Use with X2 extensions to assure maximum WiFi coverage.		NSOKA



NSOSAVC



NSORAVC



NSOKPS



FLOCK1



NSOFSB



FSPFP6X



FSPHD6X



NSOKA



Customize the jack selections and look

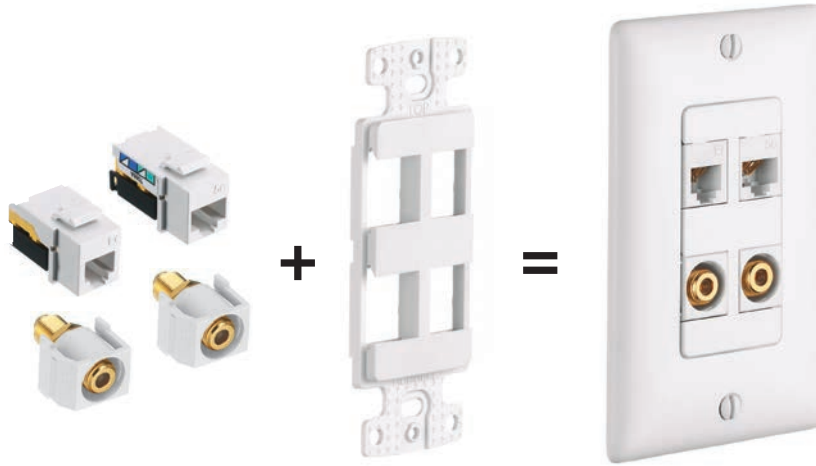

Molded-In Voice/Low-Speed Data - Modular Snap Fit

Color	Category 6 Jack (single)	Category 6 Jack (25 pack)	Category 5e Jack (single)	Category 5e Jack (25 pack)	USOC Jack (single)
Black	NSJ6BK	NSJ6BK25	NSJ5EBK	NSJ5EBK25	NSJUBK
Blue	NSJ6B	NSJ6B25	NSJ5EB	NSJ5EB25	NSJUB
Gray	NSJ6GY	NSJ6GY25	NSJ5EGY	NSJ5EGY25	NSJUGY
Green	NSJ6GN	NSJ6GN25	NSJ5EGN	NSJ5EGN25	NSJUGN
Ivory	NSJ6I	NSJ6I25	NSJ5EI	NSJ5EI25	NSJUI
Light Almond	NSJ6LA	NSJ6LA25	NSJ5ELA	NSJ5ELA25	NSJULA
Orange	NSJ6OR	NSJ6OR25	NSJ5EOR	NSJ5EOR25	NSJUOR
Red	NSJ6R	NSJ6R25	NSJ5ER	NSJ5ER25	NSJUR
White	NSJ6W	NSJ6W25	NSJ5EW	NSJ5EW25	NSJUW
Yellow	NSJ6Y	NSJ6Y25	NSJ5EY	NSJ5EY25	NSJUY

Audio/Video Connectors - Standard Bulkhead

Color	Nickel F-Type Coupler Bulkhead, Female to Female	Gold F-Type Coupler Bulkhead, Female to Female	RCA Gold Pass Through, Female to Female, Red Interior	RCA Gold Pass Through, Female to Female, White Interior	RCA Gold Pass Through, Female to Female, Yellow Interior	RCA Gold Pass Through, Female to Female, Blue Interior	RCA Gold Pass Through, Female to Female, Green Interior
Black	NSF70BK	SFFGBK	SFRCRFFBK	SFRCWFFBK	SFRCYFFBK	SFRCBFFBK	SFRCGNFFBK
Gray	NSF70GY	SFFGGY	SFRCRFFGY	SFRCWFFGY	SFRCYFFGY	SFRCBFFGY	SFRCGNFFGY
Ivory	NSF70I	SFFGEI	SFRCRFFEI	SFRCWFFEI	SFRCYFFEI	SFRCBFFEI	SFRCGNFFEI
Light Almond	NSF70LA	SFFGLA	SFRCRFFLA	SFRCWFFLA	SFRCYFFLA	SFRCBFFLA	SFRCGNFFLA
White	NSF70W	SFFGW	SFRCRFFW	SFRCWFFW	SFRCYFFW	SFRCBFFW	SFRCGNFFW

Audio/Video Connectors - Recessed

Color	Gold F-Type Coupler Bulkhead, Female to Female	RCA Gold Pass Through, Female to Female, Red Interior	RCA Gold Pass Through, Female to Female, White Interior	RCA Gold Pass Through, Female to Female, Yellow Interior	RCA Gold Pass Through, Female to Female, Blue Interior	RCA Gold Pass Through, Female to Female, Green Interior	Blank Insert
Black	SFGRFBK	SFRCRRBK	SFRCWRBK	SFRCYRBK	SFRCBRBK	SFRCGNRBK	SFSBBK10*
Gray	SFGRFGY	SFRCRRGY	SFRCWRGY	SFRCYRGY	SFRCBRGY	SFRCGNRGY	SFSBGY10*
Ivory	SFGRFEI	SFRCRREI	SFRCWREI	SFRCYREI	SFRCBREI	SFRCGNREI	SFSBEI10*
Light Almond	SFGRFLA	SFRCRRLA	SFRCWRLA	SFRCYRLA	SFRCBRLA	SFRCGNRLA	SFSBLA10*
White	SFGRFW	SFRCRRW	SFRCWRW	SFRCYRW	SFRCBRW	SFRCGNRW	SFSBW10*

Note: *Sold in a package of 10. Order 1 to receive a bag of 10 blanks.



Features

Decorator frames provide a stylized look for that finishing touch. This allows all devices to match. Multimedia jacks insert into frame for custom configuration.

- Elongated strap for better wall box mounting
- High impact-resistant thermoplastic frame
- UL Listed 1863 - Communication Circuit Accessory and CSA Certified

Decorator Frames

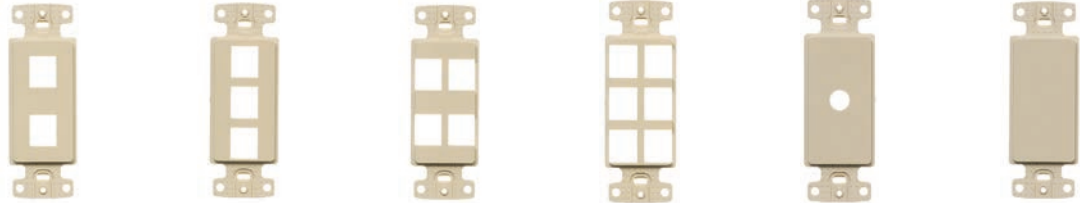

Color	1-Gang, 2-Port	1-Gang, 3-Port	1-Gang, 4-Port	1-Gang, 6-Port	1-Gang, Adapter .406" (10.30 Dia. Hole*	1-Gang, Adapter Blank**
Black	NS612BK	NS613BK	NS614BK	NS616BK	NS621BK	NS620BK
Gray	NS612GY	NS613GY	NS614GY	NS616GY	NS621GY	NS620GY
Ivory	NS612I	NS613I	NS614I	NS616I	NS621I	NS620I
Light Almond	NS612LA	NS613LA	NS614LA	NS616LA	NS621LA	NS620LA
White	NS612W	NS613W	NS614W	NS616W	NS621W	NS620W

Note: *For use with rotary dimmers or to pull through AV or telephone cable.
 **To fill an extra decorator opening or to create customized openings.

Multimedia Face Plates



Description	1-Gang, 1-Port Plate		1-Gang, 2-Port Plate		1-Gang, 3-Port Plate	
	Standard (4.63" x 2.88")	Mid-Size (4.88" x 3.13")	Standard (4.63" x 2.88")	Mid-Size (4.88" x 3.13")	Standard (4.63" x 2.88")	Mid-Size (4.88" x 3.13")
Black	NSP11BK	NSP101BK	NSP12BK	NSP102BK	NSP13BK	NSP103BK
Gray	NSP11GY	NSP101GY	NSP12GY	NSP102GY	NSP13GY	NSP103GY
Ivory	NSP11I	NSP101I	NSP12I	NSP102I	NSP13I	NSP103I
Light Almond	NSP11LA	NSP101LA	NSP12LA	NSP102LA	NSP13LA	NSP103LA
White	NSP11W	NSP101W	NSP12W	NSP102W	NSP13W	NSP103W



Description	1-Gang, 4-Port Plate		1-Gang, 6-Port Plate		2-Gang, 4-Port Plate	2-Gang, 6-Port Plate
	Standard (4.63" x 2.88")	Mid-Size (4.88" x 3.13")	Standard (4.63" x 2.88")	Mid-Size (4.88" x 3.13")	Standard (4.63" x 4.69")	Standard (4.63" x 4.69")
Black	NSP14BK	NSP104BK	NSP16BK	NSP106BK	NSP24BK	NSP26BK
Gray	NSP14GY	NSP104GY	NSP16GY	NSP106GY	NSP24GY	NSP26GY
Ivory	NSP14I	NSP104I	NSP16I	NSP106I	NSP24I	NSP26I
Light Almond	NSP14LA	NSP104LA	NSP16LA	NSP106LA	NSP24LA	NSP26LA
White	NSP14W	NSP104W	NSP16W	NSP106W	NSP24W	NSP26W



Features

Designed to complement decorator styling, these jacks offer voice and Cat. 5e devices to fit within a decorator wallplate.

- High impact-resistant thermoplastic frame
- Meets FCC part 68
- UL Listed 1863 - Communication Circuit Accessory and CSA Certified

Molded-In Voice/Low-Speed Data

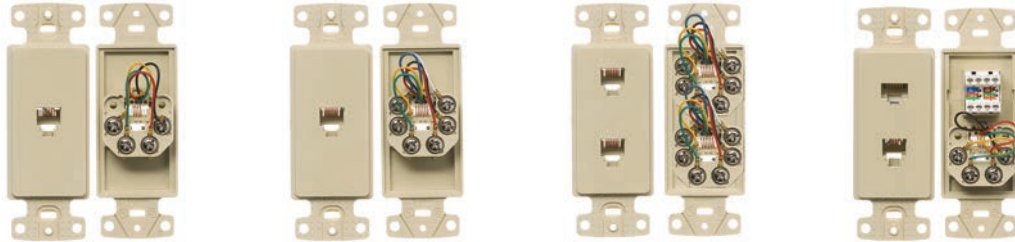

Description	Decorator Frame, One RJ11 Jack, 6-Position, 4-Conductor	Decorator Frame, One RJ11 Jack, 6-Position, 6-Conductor	Decorator Frame, Duplex RJ11 Jacks, 6-Position, 6-Conductor	Decorator Frame, One Cat. 5e 110 Punch-Down, One RJ11 Jack, 6-Position, 4-Conductor
Color	Screw Terminations	Screw Terminations	Screw Terminations	Screw Terminations
Black	NS770BK	—	—	NS784BK
Brown	NS770	NS771	—	NS784
Gray	NS770GY	—	—	NS784GY
Ivory	NS770I	NS771I	NS772I	NS784I
Light Almond	NS770LA	NS771LA	NS772LA	NS784LA
White	NS770W	NS771W	NS772W	NS784W

Features

Coaxial video and combination jacks complement multimedia needs in a 1-gang decorator opening.

- High impact-resistant thermoplastic frame
- Jacks meet FCC part 68
- UL Listed 1863 - Communication Circuit Accessory and CSA Certified

Molded-In Voice/Low-Speed Data

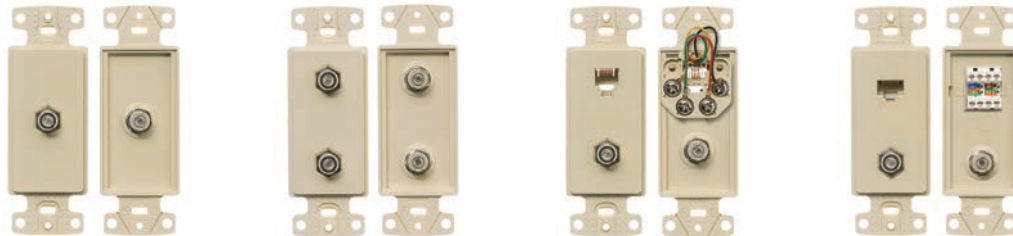

Description	Decorator Frame, Single F-Type Coupler Bulkhead, Female to Female	Decorator Frame, Duplex F-Type Coupler Bulkhead, Female to Female	Decorator Frame, One RJ11 Jack, 6-Position, 4-Conductor, One F-Type Coupler Bulkhead, Female to Female	Decorator Frame, One Cat. 5e 110 Punch-Down, One F-Type Coupler Bulkhead, Female to Female
Color	Screw Terminations	Screw Terminations	Screw Terminations	Screw Terminations
Black	—	—	—	NS785BK
Brown	—	—	—	NS785
Gray	—	—	—	NS785GY
Ivory	NS780I	NS782I	NS783I	NS785I
Light Almond	NS780LA	NS782LA	NS783LA	NS785LA
White	NS780W	NS782W	NS783W	NS785W



Features

Designed for voice, these devices provide an economical alternative to wall phone outlet placement.

- High impact-resistant thermoplastic plate
- Convenient screw down terminals
- Meets FCC part 68
- UL Listed 1863 - Communication Circuit Accessory and CSA Certified

Molded-In Plates for Voice



1-Gang Plate,
 One RJ11 Jack,
 6-Position, 4-Conductor,
 Screw Terminations



1-Gang Plate,
 One RJ11 Jack,
 6-Position, 6-Conductor,
 Screw Terminations



1-Gang Plate,
 Duplex RJ11 Jacks,
 6-Position, 4-Conductor,
 Screw Terminations



1-Gang Plate,
 Duplex RJ11 Jacks,
 6-Position, 6-Conductor,
 Screw Terminations

Description	Standard	Mid-Size	Standard	Standard	Mid-Size	Standard
Color	Standard	Mid-Size	Standard	Standard	Mid-Size	Standard
Brown	NS730	NS735	NS732	—	—	—
Ivory	NS730I	NS735I	NS732I	NS742I	NS745I	NS744I
Light Almond	NS730LA	NS735LA	NS732LA	NS742LA	—	—
White	NS730W	NS735W	NS732W	NS742W	NS745W	NS744W

Molded-In Plates for Voice and CATV/Satellite



1-Gang Plate,
 One F-Type Coupler Bulkhead,
 Female to Female,
 One RJ11 Jack,
 6-Position, 6-Conductor



1-Gang Plate,
 One F-Type Coupler Bulkhead,
 Female to Female,
 One RJ11 Jack,
 6-Position, 4-Conductor



1-Gang Plate,
 One F-Type Coupler Bulkhead,
 Female to Female



1-Gang Plate,
 Duplex F-Type Coupler Bulkhead,
 Female to Female

Description	Standard	Mid-Size	Standard	Standard	Mid-Size	Standard
Color	Standard	Mid-Size	Standard	Standard	Mid-Size	Standard
Ivory	NS748I	NS755I	NS747I	NS750I	NS751I	NS752I
Light Almond	NS748LA	NS755LA	NS747LA	NS750LA	NS751LA	NS752LA
White	NS748W	NS755W	NS747W	NS750W	NS751W	NS752W



1-Gang Plate,
 One Cat. 5e 110 Punch-Down
 One RJ11 Jack,
 6-Position, 4-Conductor
 One F-Type Coupler Bulkhead,
 Female to Female

Description	Standard
Color	Standard
Black	NS790BK
Brown	NS790
Gray	NS790GY
Ivory	NS790I
Light Almond	NS790LA
White	NS790W



Features

Designed for voice applications, these jacks provide an economical alternative to basic wall mount and performance needs.

- Available in high impact-resistant thermoplastic or stainless steel
- Meets FCC part 68
- UL Listed 1863 - Communication Circuit Accessory and CSA Certified

Telephone Wall Jacks





			
Description	Wall Phone Jack Quick Connect, 6-Position, 4-Conductor, Punch-Down Termination Tool Included	Wall Phone Jack, 6-Position, 4-Conductor, Screw Terminations	Wall Phone Jack, 6-Position, 6-Conductor, Screw Terminations
Ivory	NS721I	NS722I	NS725I
Light Almond	—	—	NS725LA
White	NS721W	NS722W	NS725W
			
Description	Wall Phone Jack Quick Connect, 6-Position, 4-Conductor, Punch-Down Termination Tool Included	Wall Phone Jack, 6-Position, 4-Conductor, Screw Terminations	
Stainless Steel	NS723SS	NS726SS	

Features

Telephone surface mount jacks are available in 4- or 6-conductor configurations for voice. Alternatively, multimedia surface mount boxes can be custom loaded for computer and media use.

- High impact-resistant thermoplastic
- Mounts using screws or double sided tape (both included)
- Meets FCC part 68
- UL Listed 1863 - Communication Circuit Accessory and CSA Certified

Telephone Wall Jacks

				
Description	Telephone Surface Mount Jack, 6-Position, 4-Conductor, Screw Terminations	Telephone Surface Mount Jack, 6-Position, 6-Conductor, Screw Terminations	Multimedia 1-Port Surface Mount Box, Jack Not Included	Multimedia 2-Port Surface Mount Box, Jacks Not Included
Ivory	NS760I	NS761I	ISB1E1*	ISB2E1*
White	NS760W	NS761W	ISB1W*	ISB2W*

Note: *cULus Listed 1863 - Communication Circuit Accessory. See page W-22 for snap fit multimedia jacks and AV connectors.