

# ALED<sup>®</sup> 50W 78W 105W 125W 150W INSTRUCTIONS

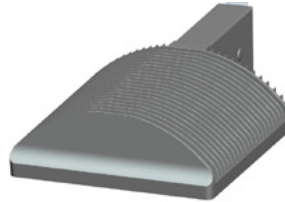

Thank you for buying RAB lighting fixtures. Our goal is to design the best quality products to get the job done right. We'd like to hear your comments. Call the Marketing Department at 888-RAB-1000 or email: [marketing@rabweb.com](mailto:marketing@rabweb.com)



## IMPORTANT

**READ CAREFULLY BEFORE INSTALLING FIXTURE. RETAIN THESE INSTRUCTIONS FOR FUTURE REFERENCE.**

RAB fixtures must be wired in accordance with the National Electrical Code and all applicable local codes. Proper grounding is required for safety. This product must be installed in accordance with the applicable installation code by a person familiar with the construction and operation of the product and the hazards involved.

**WARNING: Make certain power is OFF before installing or maintaining fixture. No user serviceable parts inside.**

## MOUNTING ARM ON FIXTURE

1. Remove the **Arm Cover** from the **Arm**.
2. Feed wires from **Fixture** through **Gasket** into **Arm**.
3. Line up **Arm** and **Fixture**. Place flat washers, lock washers and nuts on the **Short 3/8-16 bolts** inside the **Arm** and tighten securely to housing.
4. Make sure the **Gasket** is secure between **Arm** and **Fixture**.

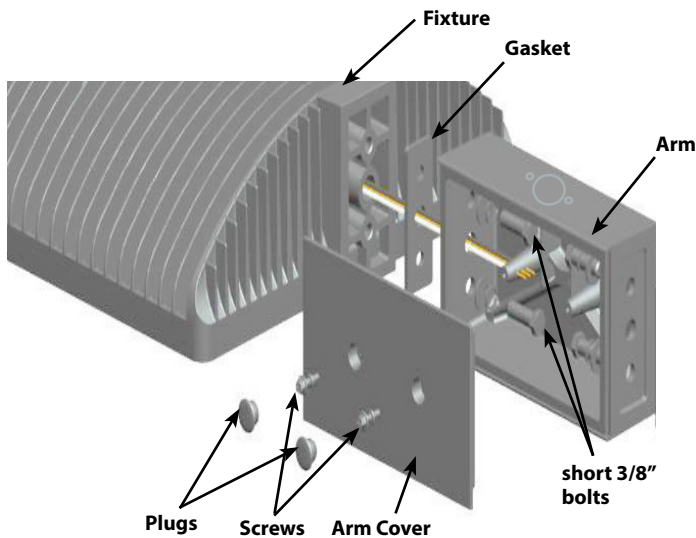

## MOUNTING FIXTURE DIRECTLY TO POLE

Check that pole is drilled according to Pole Drawing Detail.

1. Remove the **Arm Cover** from the **Arm**.
2. Feed wires from **Fixture** through **Gasket** into **Arm**. Feed supply wires from **Pole** through **Gasket** into **Arm**.
3. Insert **Long 3/8-16 bolts** through **Arm, Gasket, Pole** and thread into the **Bolster Plate**. Be sure the **Gasket** is between the **Arm** and pole and secure with bolts, washers and lockwashers.
4. Make necessary connections inside the **Arm** and knot wires for strain relief.
5. Replace the **Arm Cover**. Be sure the **Gasket** on **Arm Cover** is in place. Tighten **Screws** and add the **Plugs**. Secure **Pole cap**.

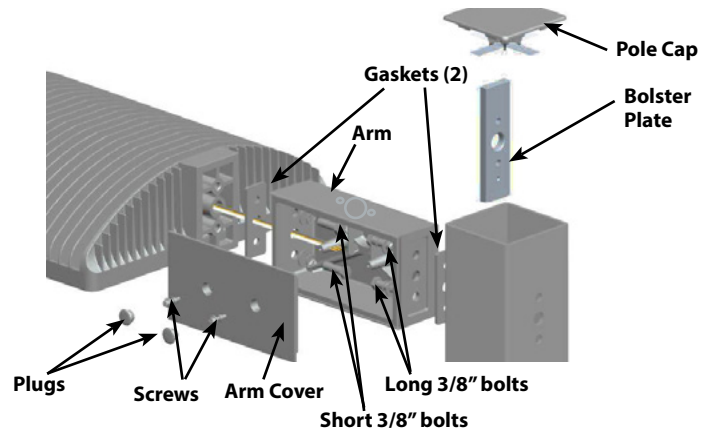

# ALED® 50W 78W 105W 125W 150W INSTRUCTIONS



Thank you for buying RAB lighting fixtures. Our goal is to design the best quality products to get the job done right. We'd like to hear your comments. Call the Marketing Department at 888-RAB-1000 or email: marketing@rabweb.com

## ROUND POLE ADAPTOR ACCESSORY

For use with standard RAB pole drilling.

1. Drill round pole using the dimensions shown in the Pole Drilling Detail.
2. Place **Round Pole Adaptor (RPA)** and **RPA Gasket** between the fixture and drilled **Pole** as shown.
3. Line up top holes of the **Gaskets** and **Round Pole Adaptor** with top hole in the pole drilling pattern.
4. Place **long 3/8" Bolts** from the **ALED** thru the top hole of the RPA and Gaskets to the Round **Pole** thread into **Bolster Plate**.
5. Feed wires from **Fixture** through **Gasket** into **Arm**. Feed supply wires from **Pole** through **Gasket** into **Arm**. Make necessary connections inside the **Arm** and knot wires for strain relief.
6. Replace the **Arm Cover**, tighten **Screws** and add the **Plugs**. Secure Pole cap.

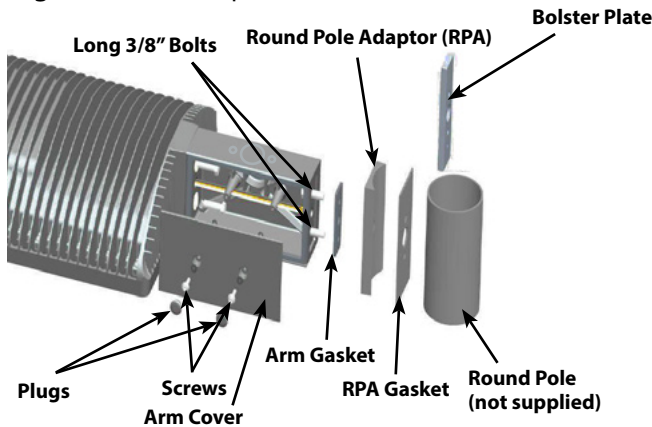

## PHOTOCELL INSTALLATION

Photocell may be installed in the field. Apply weatherproof silicone sealant to all plugs and unused conduit entries.

1. Remove close up plug on top of the wall mounting box.
2. Install photocell and wire as per diagram.
3. Use photocell rated for your supply voltage.

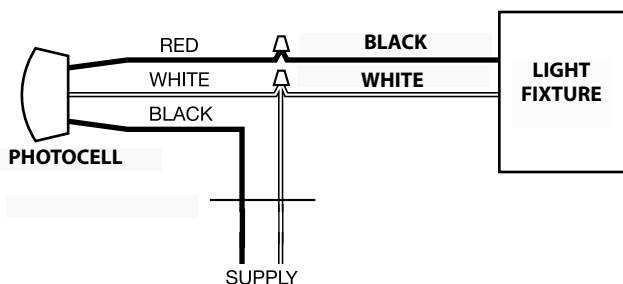

## ON-OFF WIRING

Universal voltage driver permits operation at 120V thru 277V, 50 or 60 Hz. Units ordered with (/480V) suffix are 480V, 60Hz. For Non-Dimming, follow the wiring directions as in fig. 1.

1. Connect the black fixture lead to the (+) LINE supply lead.
2. Connect the white fixture lead to the (-) COMMON supply lead.
3. Connect the GROUND wire from fixture to supply ground.

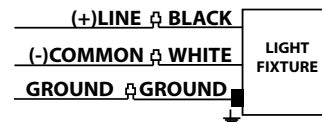

Fig. 1

## 0-10V DIMMABLE WIRING

Universal voltage driver permits operation at 120V thru 277V, 50 or 60 Hz. For 0-10V Dimming, follow the wiring directions as in fig. 2.

1. Connect the black fixture lead to the (+) LINE supply lead.
2. Connect the white fixture lead to the (-) COMMON supply lead.
3. Connect the GROUND wire from fixture to supply ground. Do NOT connect the GROUND of the dimming fixture to the output.
4. Connect the purple fixture lead to the (V+) DIM lead.
5. Connect the gray fixture lead to the (V-) DIM lead.
6. Cap the yellow fixture lead, if present. Do NOT connect.

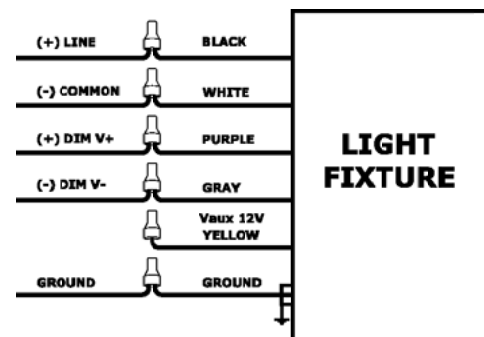

Fig. 2

# ALED<sup>®</sup> 50W 78W 105W 125W 150W INSTRUCTIONS



Thank you for buying RAB lighting fixtures. Our goal is to design the best quality products to get the job done right. We'd like to hear your comments. Call the Marketing Department at 888-RAB-1000 or email: [marketing@rabweb.com](mailto:marketing@rabweb.com)

## POLE DRILLING DETAIL

For non-RAB poles use these dimensions to drill the pole. This template is not to scale. Please use measurements shown.

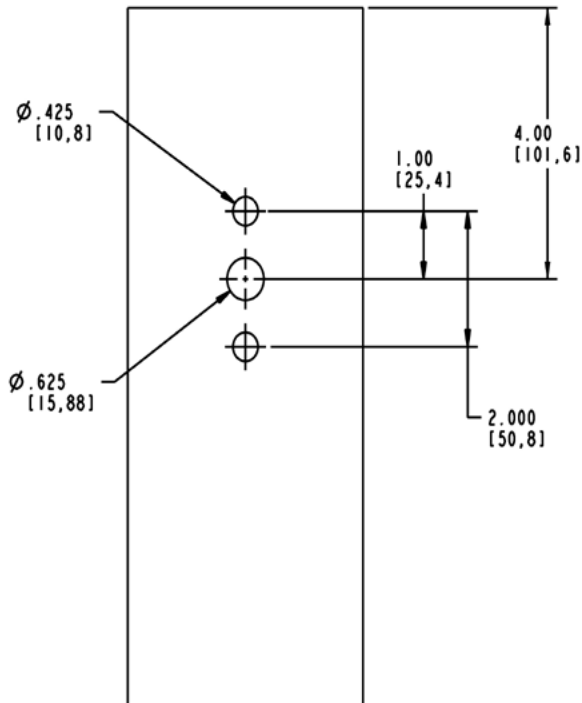

## CLEANING & MAINTENANCE

**CAUTION: Be sure fixture temperature is cool enough to touch. Do not clean or maintain while fixture is energized.**

1. Clean glass lens with non-abrasive glass cleaning solution.
2. Do not open fixture to clean the LED. Do not touch the LED.

## TROUBLESHOOTING

1. Check that the line voltage at the fixture is correct. Refer to wiring directions.
2. Be sure the fixture is grounded properly.
3. Is the photocell, if used, functioning properly?

Patent: US: pat. D668,370

*Note: These instructions do not cover all details or variations in equipment nor do they provide for every possible situation during installation, operation or maintenance.*



## Easy Installation & Product Help

**Tech Help Line**  
Call our experts 888 RAB-1000

**rabweb.com**  
Visit our website for product info

**email**  
Answered promptly [sales@rabweb.com](mailto:sales@rabweb.com)