

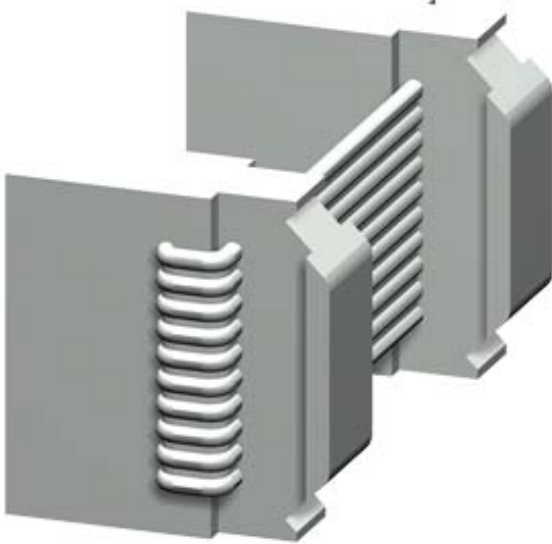



CONNECTION CABLE; LENGTH 0,3M; FLAT; CONNECTION OF BASIC UNIT TO CURRENT MEASURING MODULE, CURRENT/VOLTAGE MEASUR. MODULE, OPERATOR PANEL OR TO EXPANSION MODULES VIA SYSTEM INTERFACE









General technical data:

| | |
|------------------------------|---|
| product brandname | SIRIUS |
| Product designation | Connection cable/length 0.3 m/flat |
| Design of the product | For connection of the system components |
| Ambient temperature | |
| • during storage | -40 ... +80 °C |
| • during operation | -25 ... +60 °C |
| • during transport | -40 ... +80 °C |

Certificates/ approvals:

| | | | | |
|---|---|---|--|--|
| General Product Approval | EMC | Test Certificates | | Shipping Approval |
|  UL |  |  C-Tick | Type Test Certificates/Test Report | Special Test Certificate  ABS |

| | | | | | |
|---|--|---|--|---|------------------------------|
| Shipping Approval | | | | | other |
|  BUREAU VERITAS |  DNV |  GL |  PRS |  RMRS | Confirmation |

| | | |
|---|--|---|
| other | | |
| PROFIsafe-Certification | PROFINET-Certification |  Profibus |

Further information

Information- and Downloadcenter (Catalogs, Brochures,...)

<http://www.siemens.com/industrial-controls/catalogs>

Industry Mall (Online ordering system)

<https://mall.industry.siemens.com/mall/en/en/Catalog/product?mlfb=3UF7935-0AA00-0>

Cax online generator

<http://support.automation.siemens.com/WW/CAXorder/default.aspx?lang=en&mlfb=3UF7935-0AA00-0>

Service&Support (Manuals, Certificates, Characteristics, FAQs,...)

<https://support.industry.siemens.com/cs/ww/en/ps/3UF7935-0AA00-0>

Image database (product images, 2D dimension drawings, 3D models, device circuit diagrams, EPLAN macros, ...)

http://www.automation.siemens.com/bilddb/cax_de.aspx?mlfb=3UF7935-0AA00-0&lang=en

