

New cutting tools and solutions

CoroPak **14.1**



To order your new tools...

New tools

Supplement 14.1

Complete offer Internet

Publications

SANDVIK Coromant

Complete offer available digitally in the application Publications

Welcome...

At Sandvik Coromant, we are driven by a passion for excellence. By continuously applying and developing our competence, we set high standards for all of our products and solutions.

Meet Inveio™, the technical breakthrough of uni-directional crystal orientation that makes the unbeatable performance of GC4325 and our other new grades possible.

Our offer is based on the very best technology and superior knowledge of the customers' needs. So go ahead and take a look at our new cutting tools and solutions!



Klas Forsström
President Sandvik Coromant

You'll find it all and more online...

Today's way of doing business is changing all the time. We expect to find information and answers to our queries right here, right now, and more and more often online.

We want to have the best setup to serve you, our customers and partners in the industry, to make the search for information and decision-making easy and convenient.

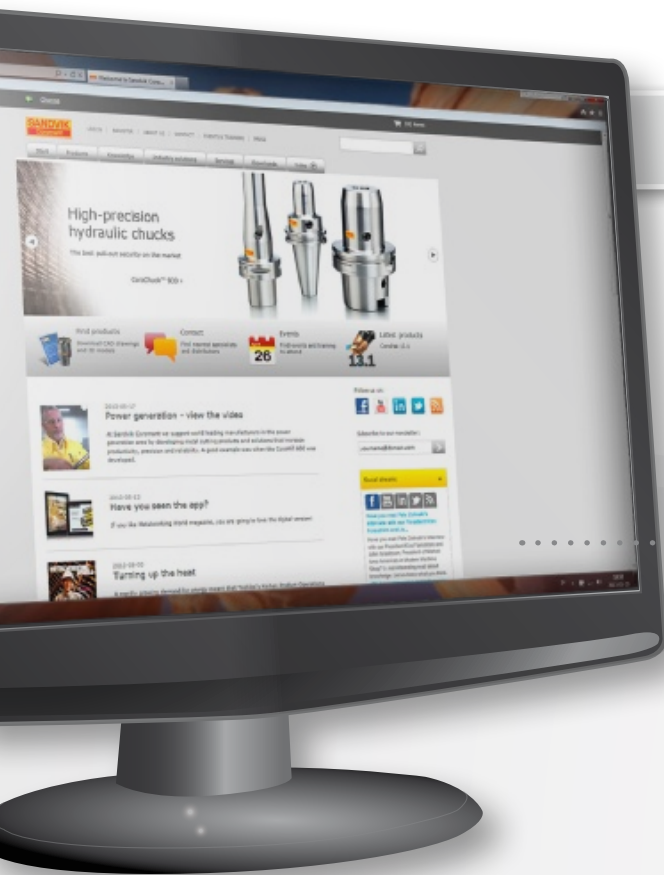

www.sandvik.coromant.com

Products, solutions, tips and
a wealth of knowledge, just
one click away!

*Why not sign up for
our monthly newsletter and have the
latest news on developments and solutions
delivered right into your inbox!*

Sandvik Coromant on YouTube

With over 200 engaging videos and animations www.youtube.com/sandvikcoromant provides you with everything from application knowledge and technical solutions for different kinds of machining, tips and tricks for how to use that new tool, to footage from training events.

YouTube





Download our apps here:



Product news – What is new in metal cutting?

Loaded with technical information, great graphics and animations, this app presents our new products and solutions in a totally new dimension.

Publications – Thousands of pages in one app

Browse existing materials, create your own catalogues and enjoy a more seamless approach to online shopping. Experience the application suite both on your mobile and stationary devices, online and offline.

...and smart apps for metal cutting

Whether it's finding the right insert, calculating your start values or optimizing cut settings to maximize the performance of all your machining applications, we have an app for that too.

Social media – Yes, we are here too!

...everyday, checking in with hot news, following your posts and solving burning issues. Join us and be part of the dialogue.



Table of contents

SOLUTIONS	
Automotive	16
Oil and gas/aerospace	20
Parting and grooving	28
Holemaking	38
Productivity	48
GENERAL TURNING	
Grade GC4325	8
Grade GC4315	8
CoroTurn® SL cutting heads with CoroTurn® HP	19
CoroTurn® HP connection kit	56
PARTING AND GROOVING	
CoroCut® QD	22
CoroCut® 1-2	26
MILLING	
Grade GC3330	14
CoroMill® 345, stainless steel	30
CoroMill® 495, chamfer cutter	32
CoroMill® Plura, Tailor Made end mills	34
CoroMill® Plura, PCD	35
CoroMill® Plura, thread milling cutters	36
DRILLING	
CoroDrill® 860, stainless steel	40
CoroDrill® 870	42
New vibration damper	46
CoroDrill® 800/801, L-geometry	47
Gun drills	47
TPGX inserts	47
TAPPING	
CoroTap™ -XM	44
TOOLING SYSTEMS	
Coromant Capto®, quick change clamping units	50
CoroChuck™ 930	52
BIG-PLUS® solid holder	55
Integrated ER adaptors	57
Coromant Capto®, Silent Tools™ clamping units	57
Quick change tap adaptor	57
Rotating adaptors	57
TOOL KITS	
Start-up tool kits	56
INFO	
Tailor Made	58
Latest CoroPak releases	59
Reference	60
About Sandvik Coromant	61

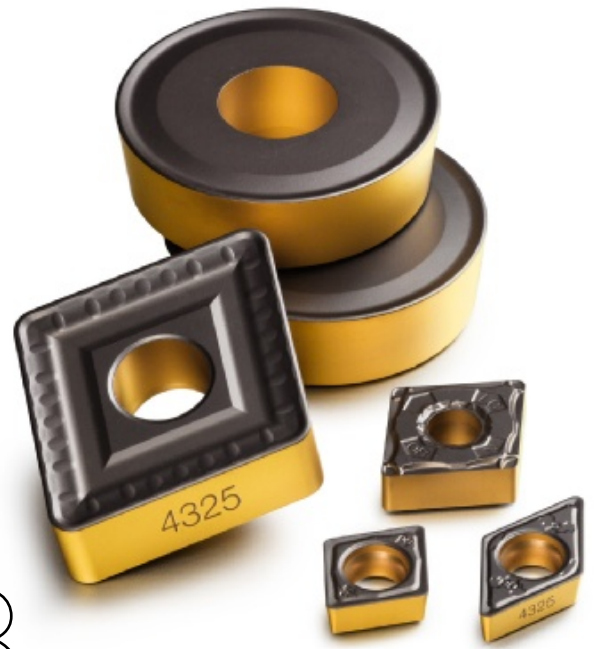

8



Grade GC4325

Predictable performance in the most varying conditions – GC4325 is the first choice grade when turning steel.



22

CoroCut® QD

Secure parting off system with efficient plug and play coolant supply.

Inveio™



BIG-PLUS®



Efficient coolant delivery



Deep hole machining

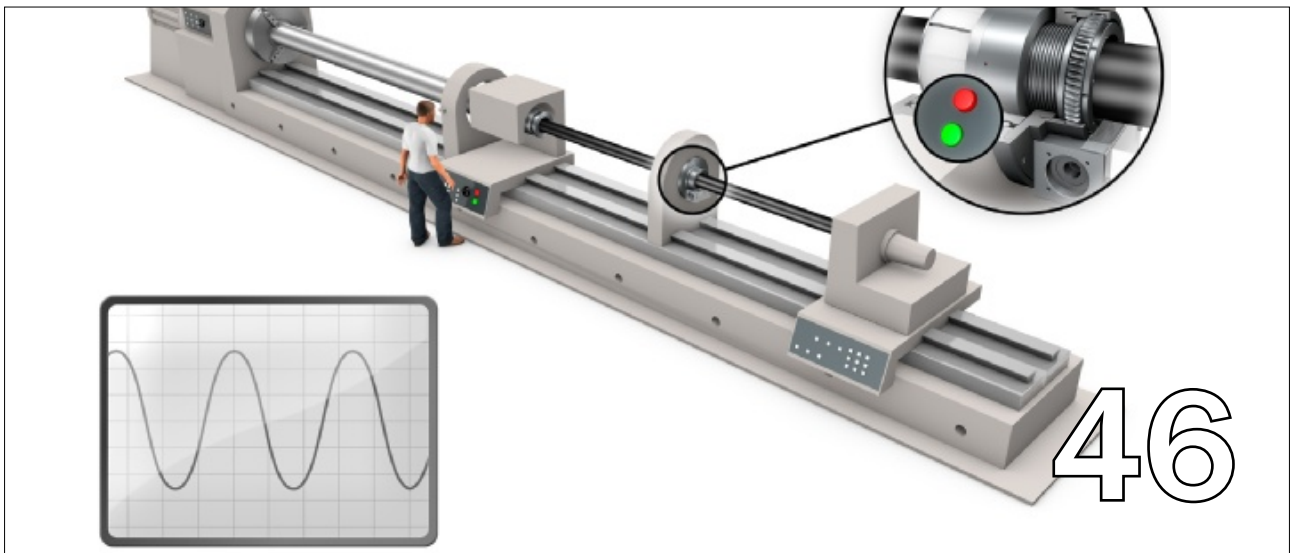

The next generation of grades

Inserts built to last

Are you looking for inserts that ensure wear resistance and high edge-line security?
Well, look no further.

Meet our three grades equipped with Inveio™, the technical breakthrough of uni-directional crystal orientation that makes the unbeatable performance of GC4325, GC4315 and GC3330, possible.



Inveio™

Uni-directional crystal orientation

The material science behind

In conventional CVD alumina coatings, crystal growth direction is random. When developing Inveio™, our experts found a way to control the growth in this coating layer, to ensure that all of the crystals lined up in the same direction, with the strongest part towards the top surface. This can be seen in the microscope images below where each crystal direction is given a unique colour.

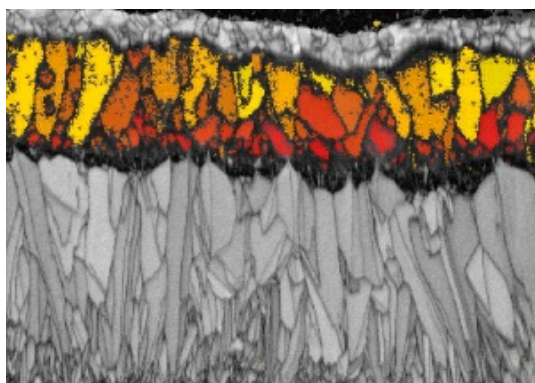

In conventional CVD alumina coatings the crystal orientation is random.



With Inveio, every crystal in the alumina coating is lined up in the same direction, towards the top surface.

Why is the crystal orientation important?

The tightly-packed uni-directional crystals create a strong barrier towards the cutting zone and chip. This greatly improves both crater as well as flank wear resistance. Another effect is that heat is more rapidly lead away from the cutting zone, making the cutting edge stay in shape for longer times in cut. Cutting edges that last longer, that is Inveio.

Predictability and long tool life

The effect of the Inveio coating is combined with all the other details on the insert: the substrate, the shape of the cutting edge and the post-treatment process. Together this results in grades with long and predictable tool life.

Grades GC4325 and GC4315

Steel turning endurance

Predictable performance

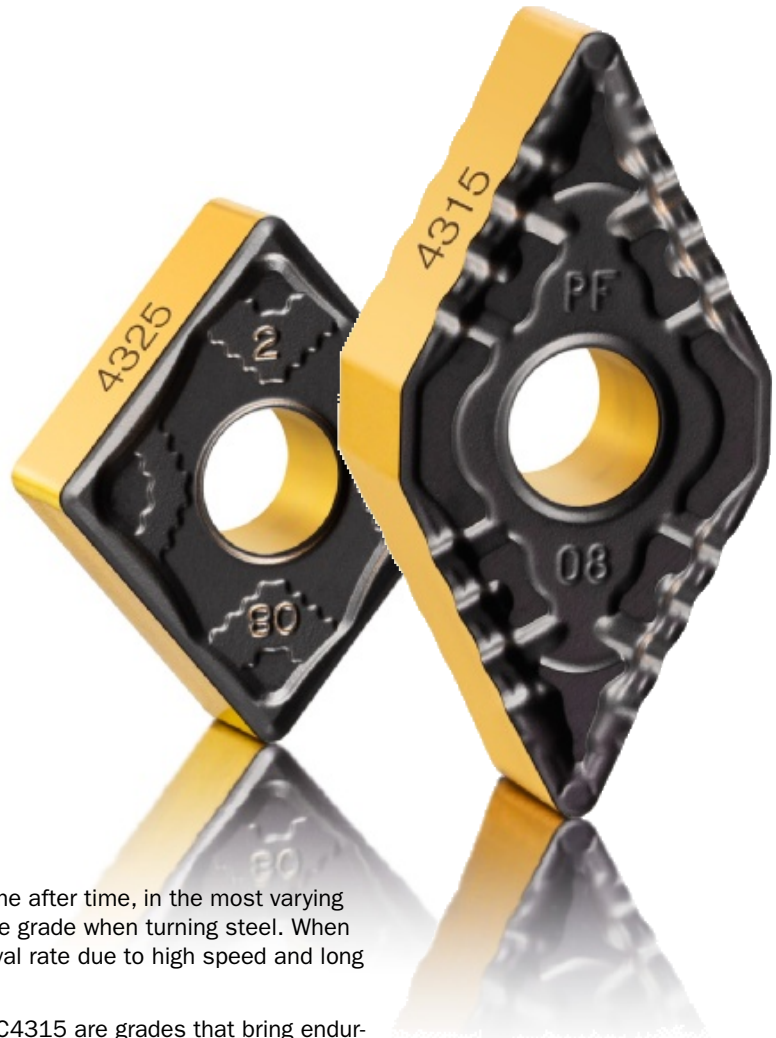

Ensuring same reliable performance time after time, in the most varying conditions – GC4325 is your first choice grade when turning steel. When GC4325 reaches a limit in metal removal rate due to high speed and long time in cut, GC4315 will do the job.

Equipped with Inveio™, GC4325 and GC4315 are grades that bring endurance, predictability and long tool life to your steel turning operations.

Benefits

GC4325 – first choice for steel turning

- Long tool life – improved machine utilization
- Predictable performance – high security in unmanned operations
- Broad application area – reduced tool inventory

GC4315 – your option for high metal removal rate

- Withstands high cutting temperatures – allows for high cutting speed and long time in cut
- Predictable performance – perfect for secure unmanned mass production
- High metal removal rate without compromising tool life

Application

- External and internal turning
- Roughing to finishing
- Wet and dry machining

GC4325

- First choice for a majority of steel turning applications
- Continuous to interrupted cuts

GC4315

- Continuous to light-interrupted cuts
- High cutting speed
- Long time in cut
- Hard workpiece materials

P

ISO application area

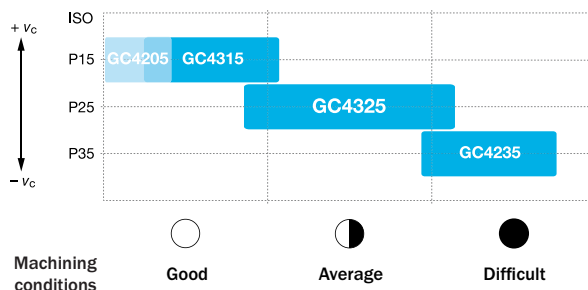

For cutting data recommendations, see Supplement 14.1.

Technical features

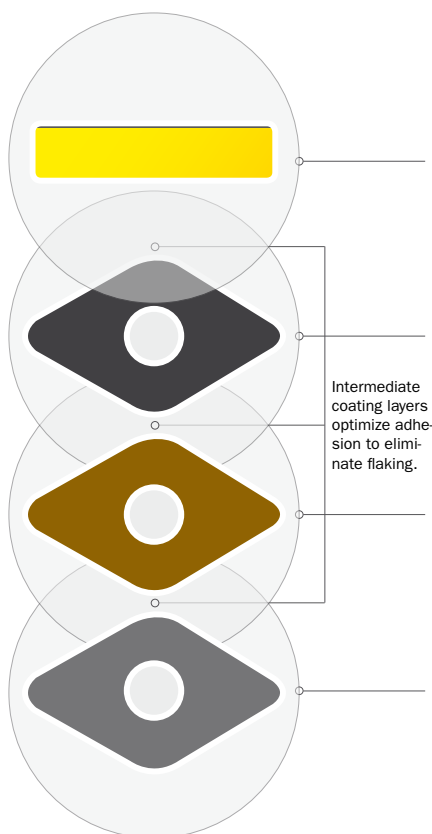

Top coating TiN

A bright yellow top TiN coating on the insert flank allows for easy wear detection.

Alumina coating – Inveio™

Inveio enables high wear resistance and long tool life.

More Inveio, page 6.

Intermediate coating layers optimize adhesion to eliminate flaking.

Inner coating

Columnar MT-TiCN coating, a hard and wear resistant coating against abrasive wear.

Substrate

The cemented-carbide substrate is balanced to give high strength and reliable toughness. Cobalt-enriched surface gradient adds to security.

- The GC4325 substrate is balanced for security in a wide range of operations.
- The GC4315 substrate is carefully developed to withstand high temperatures, which typically occur at high cutting speeds, long times in cut and turning in hard workpiece material.

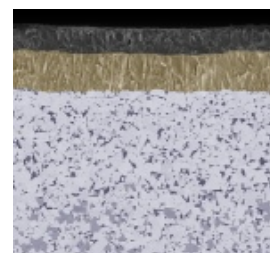

GC4325

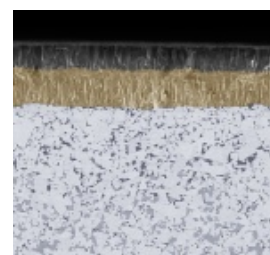

GC4315

Performance GC4325

Hydraulic mobile cylinder caps

Customer case		
Operation	External, axial- and face turning	
Workpiece material	Low-alloy steel, P2.1.Z.AN (200 HB)	
Coolant	Emulsion	
Time in cut, min/component	0.3	
Cutting data		
v_c m/min (ft/min)	250 (820)	
f_n mm/r (in/rev)	0.3 (0.011)	
a_p mm (inch)	2.0 (0.078)	
Results		
	GC4325	Competitor
Insert ISO (ANSI)	CNMG 120408-PM (CNMG 432-PM)	CNMG 120408 (CNMG 432)
Tool life, pcs	63	26



GC4325

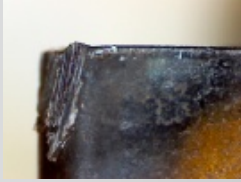

Competitor

As the competitor insert broke due to wear, the GC4325 insert lasted significantly longer with a stable and predictable wear.

Automotive axle

Customer case		
Operation	External, axial- and face turning	
Workpiece material	Low-alloy steel, P2.1.Z.AN (200 HB)	
Coolant	Emulsion	
Time in cut, min/component	0.1	
Cutting data		
v_c m/min (ft/min)	282 (925)	
f_n mm/r (in/rev)	0.15 (0.006)	
a_p mm (inch)	0.5 (0.02)	
Results		
	GC4325	Competitor
Insert ISO (ANSI)	VBMT 160404-PM (VBMT 331-PM)	VBMT 160404 (VBMT 331)
Tool life, pcs	900	300

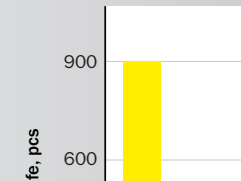

GC4325

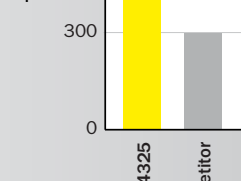

Competitor

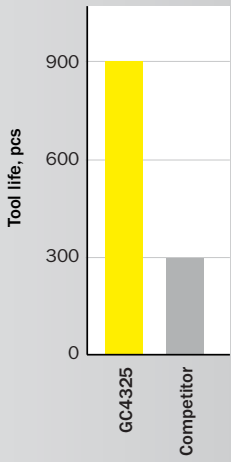

Tool	Tool life, pcs
GC4325	900
Competitor	300

In this operation GC4325 showed much better edge-line security and gave three times the tool life compared to the competitor.

Hydraulic housing

Customer case		
Operation	Roughing, internal axial turning (L=10xD anti-vibration bar)	
Workpiece material	Low-alloy steel, P2.1.Z.AN (210 HB)	
Coolant	Emulsion	
Time in cut, min/component	0.24	
Cutting data		
v_c m/min (ft/min)	250 (820)	
f_n mm/r (in/rev)	0.25 (0.001)	
a_p mm (inch)	1.1 (0.043)	
Results		
	GC4325	Competitor
Insert ISO (ANSI)	DCMT 11T308-PM (DCMT 3(2.5)2-PM)	DCMT 11T308 (DCMT 3(2.5)2)
Tool life, pcs	389	127

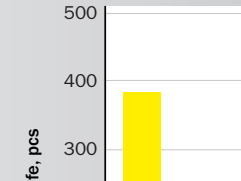

GC4325

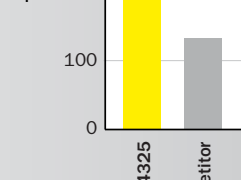

Competitor

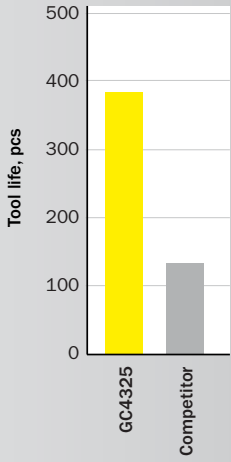

Tool	Tool life, pcs
GC4325	389
Competitor	127

GC4325 gave a secure performance and lasted more than three times longer than the competitor in this turning operation with long overhang.

Performance GC4315

Adaptor housing

Customer case		
Operation	External, axial- and face turning	
Workpiece material	Low-alloy steel, P2.5.Z.HT (335 HB)	
Coolant	Emulsion	
Time in cut (min/component)	19.24	
Cutting data		
v_c m/min (ft/min)	168 (551)	
f_n mm/r (in/rev)	0.35 (0.014)	
a_p mm (inch)	3 (0.118)	
Results		
	GC4315	Competitor
Insert ISO (ANSI)	CNMG 120408-PM (CNMG 432-PM)	CNMG 120408 (CNMG 432)
Tool life, min	38.5	23.1
<p>GC4315 machined two complete components where the competitor insert only managed to machine 1.2 components. This was due to better abrasive crater-wear resistance for GC4315, crucial at this long time in cut.</p>		



GC4315



Competitor

Drive shaft

Customer case		
Operation	External profile turning	
Workpiece material	Low-alloy steel, P2.1.Z.AN (200 HB)	
Coolant	Emulsion	
Time in cut, min/component	0.32	
Cutting data		
v_c m/min (ft/min)	350 (1148)	
f_n mm/rev (in/rev)	0.35 (0.014)	
a_p mm (inch)	0.4 (0.016)	
Results		
	GC4315	Competitor
Insert ISO (ANSI)	VBMT 160408-PF (VBMT 332-PF)	VBMT 160408 (VBMT 332)
Tool life, pcs	130	130
<p>At this high cutting speed, GC4315 showed better flank wear resistance and edge-line security compared to the competitor insert where the coating was worn out and the substrate exposed.</p>		



GC4315



Competitor

Assortment GC4325

Tool	Insert basic shape	Insert shape	Geometry	Supplement 14.1
T-Max® P	Negative	C, D, R, S, T, V, W, L	-PF, -PM, -PR, -HM, -HR, -XH, -LK, -RK, -LC, -MF, -MR, -QM, -QR, -PMC	Chapter A
CoroTurn® 107	Positive	C, D, R, S, T, V	-MO, -WF, -PMC, -PM, -PR, -UF	Chapter A
T-Max®, T-Max® S		S, T, K		Chapter A

Assortment GC4315

Tool	Insert basic shape	Insert shape	Geometry	Supplement 14.1
T-Max® P	Negative	C, D, T, V, W	-PF, -PM, -PR, -WF, -WMX	Chapter A
CoroTurn® 107	Positive	C, D, V	-PF, -PM, -WF, -WM	Chapter A

For additional information see www.sandvik.coromant.com

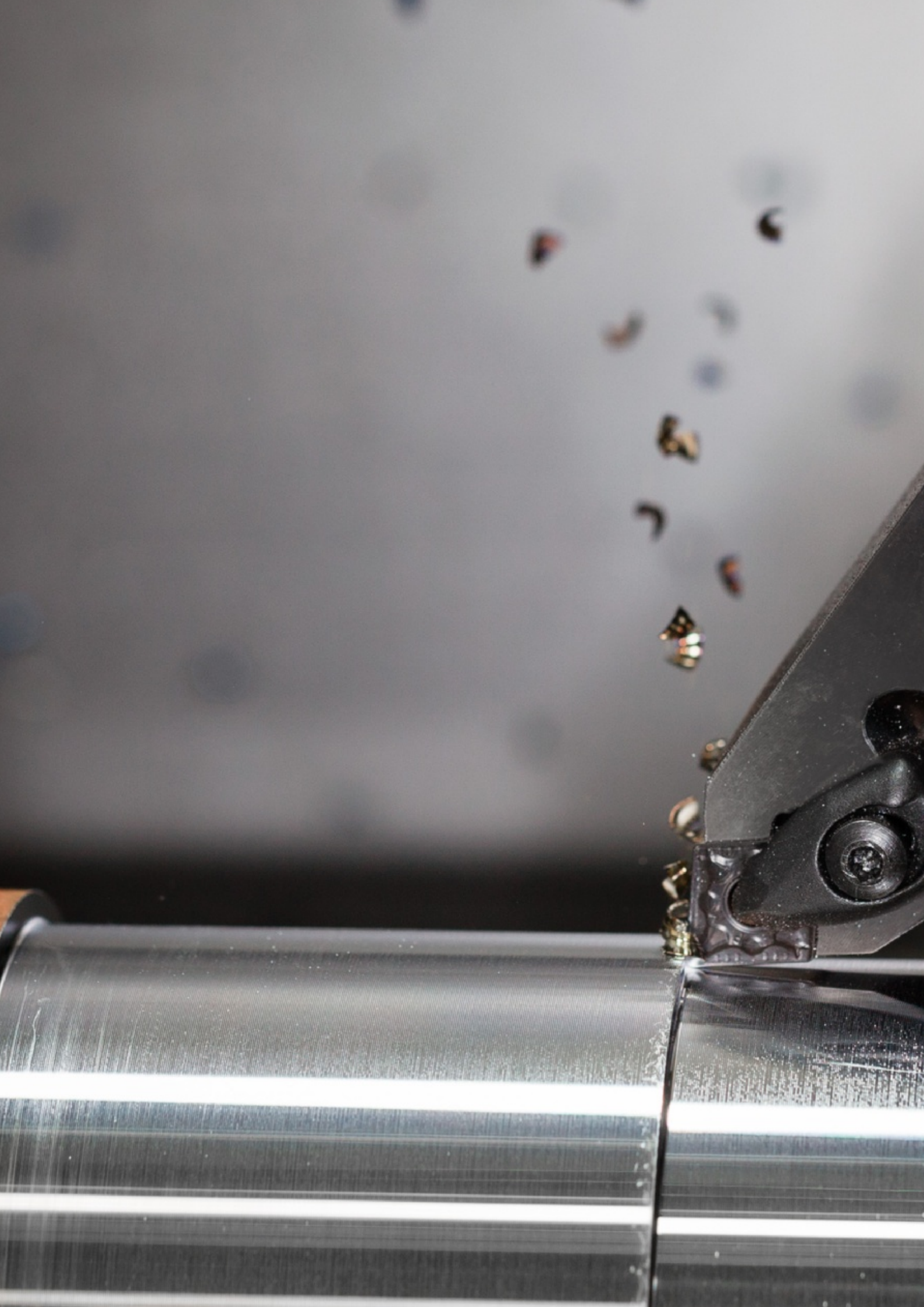



Grade GC3330

First choice for cast iron milling

For all cast iron applications

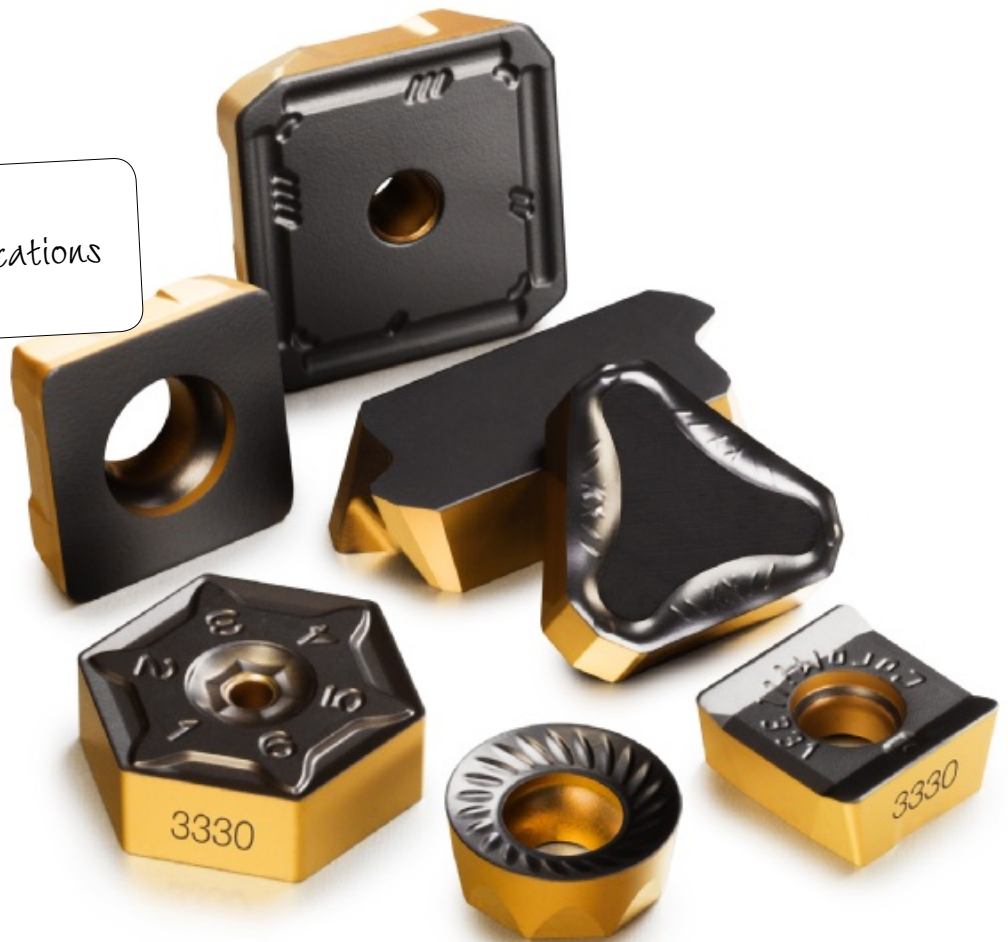

The new GC3330 is a versatile first choice grade that can be used in both dry and wet cast iron milling. Inveio™ gives the inserts endurance and wear resistance, perfect if you want inserts with long tool life and predictable wear.

Benefits

- Reliable milling with predictable wear
- Secure grade for unmanned production
- Long tool life at high cutting data
- Broad application area – use the same insert for many different applications



ISO application area

Machining conditions

- Good
- Average
- Difficult

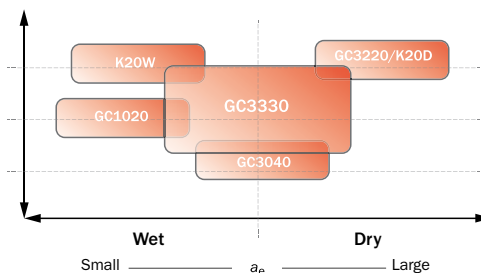

Application

- First choice for cast iron milling
- Dry and wet milling
- Roughing to finishing
- For both grey- and nodular cast iron materials

Technical features

- Inveio™ enables high wear resistance and long tool life
More Inveio, page 6
- Fine-structured MT-TiCN coating adds security by great flaking resistance
- Cemented-carbide substrate for strength and toughness

GC3330

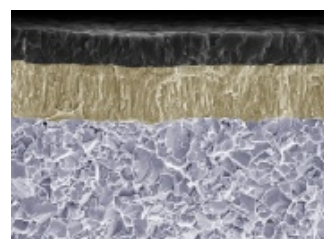

Performance

Face milling, light roughing of crankcase

Customer case		
Workpiece material	Grey cast iron, DIN GG-25, K2.1.C.UT	
Machine	ISO 50, Mazak Nexus 6800-II	
Tool and insert	R365-160Q40-W15 and R365-1505ZNE-KM	
Condition	Dry machining	
Cutting data		
v_c m/min (ft/min)	345 (1132)	
f_z mm/z (in/z)	0.38 (0.015)	
a_p mm (inch)	1.5 (0.059)	
a_e mm (inch)	106 (4.17)	
Results		
	GC3330	Competitor
Total number of components	280	200
Total machining time (min)	70	50
Tool life increase	40%	



GC3330



Competitor

With GC3330, tool life and number of components increased with 40% compared to the competitor.

Assortment

Application	Tool	Grade	Supplement 14.1
Shoulder milling	CoroMill® 390, CoroMill® 490	GC3330	Chapter D
Face milling	CoroMill® 245, CoroMill® 345, CoroMill® 365, CoroMill® 360, CoroMill® 357, CoroMill® S60, T-Max® 45, AUTO-AF, AUTO-FS, AUTO-R	GC3330	Chapter D
Profile milling	CoroMill® 200, CoroMill® 300	GC3330	Chapter D
High feed milling	CoroMill® 210, CoroMill® 419	GC3330	Chapter D
Parting and grooving milling	CoroMill® 331	GC3330	Chapter D

For additional information see www.sandvik.coromant.com

Automotive transmission in focus



Maximize efficiency and minimize production costs

Just like with any other big-volume production, factors such as security, rapid cycle times and high quality are important in transmission component manufacturing. However, objective number one is low total cost per component.

To be able to support our customers in the best way possible, Sandvik Coromant has an ambition to continually develop our application knowledge to address future challenges. Our tooling solutions and application know-how are created in a global collaboration with our customers to set a new standard in transmission manufacturing.

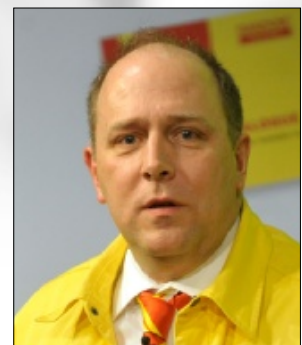

"The know-how, innovative tooling solutions and global support of Sandvik Coromant, fits perfectly with the high demands that our automotive-transmission customers place on us"

Marcel Bellorini
Senior Strategic Account Manager



See the film

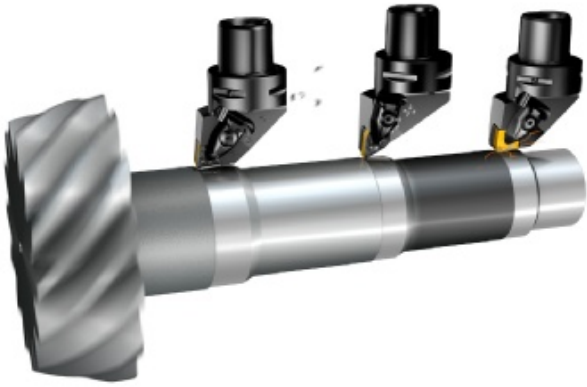

Geared up for hard-part turning

Machining of hardened steel dominates shaft- and gear manufacturing. Typically, this refers to steels with hardness between 55–65 HRC. The hardness makes such components difficult to machine due to high cutting force and temperature.

When using CBN inserts in hard-part turning, the grinding operation can be left out for increased productivity. Hard-part turning has proven to reduce machining time and costs by 70 percent or more. It offers improved flexibility, better lead times and allows for multiple operations with a single set-up. The environmental benefits are also significant – dry cutting without coolant and easier chip handling with the possibility to recycle chips.

In hard-part turning, the cutting-tool material needs to have good thermal and chemical stability, mechanical strength and resistance to abrasive wear. Our unique CBN grades CB7015 and CB7025 along with the optimized edge preparations and geometries offer a secure, reliable and predictable performance.

Soft-stage turning

Successful hard-part turning depends greatly on the soft-stage turning operation that precedes it. Well-performed soft-stage turning minimizes surface imperfections.

For this type of operation the new steel turning grades GC4315 and GC4325 with Inveio™ are simply ideal.

GC4325 – first choice for steel turning

For average cutting speeds in varying conditions, use GC4325.

GC4315 – your option for high metal removal rate

For higher cutting speeds choose GC4315. Designed for components in mass production, GC4315 get shaft- and gear turning off to the best possible start. Suitable for continuous to light interrupted cuts.



CBN insert grades

More information at www.sandvik.coromant.com



GC4315

Steel grade with Inveio™

See page 8



GC4325

Steel grade with Inveio™

See page 8

From machine to cutting edge

Chip control in terms of good chip breaking is the key to process security and in the end higher total productivity regardless of whether it is internal or external machining. For efficient coolant delivery, Sandvik Coromant offers solutions all the way from machine to cutting edge through clamping units, adaptors and holders, empowered by dedicated insert geometries.

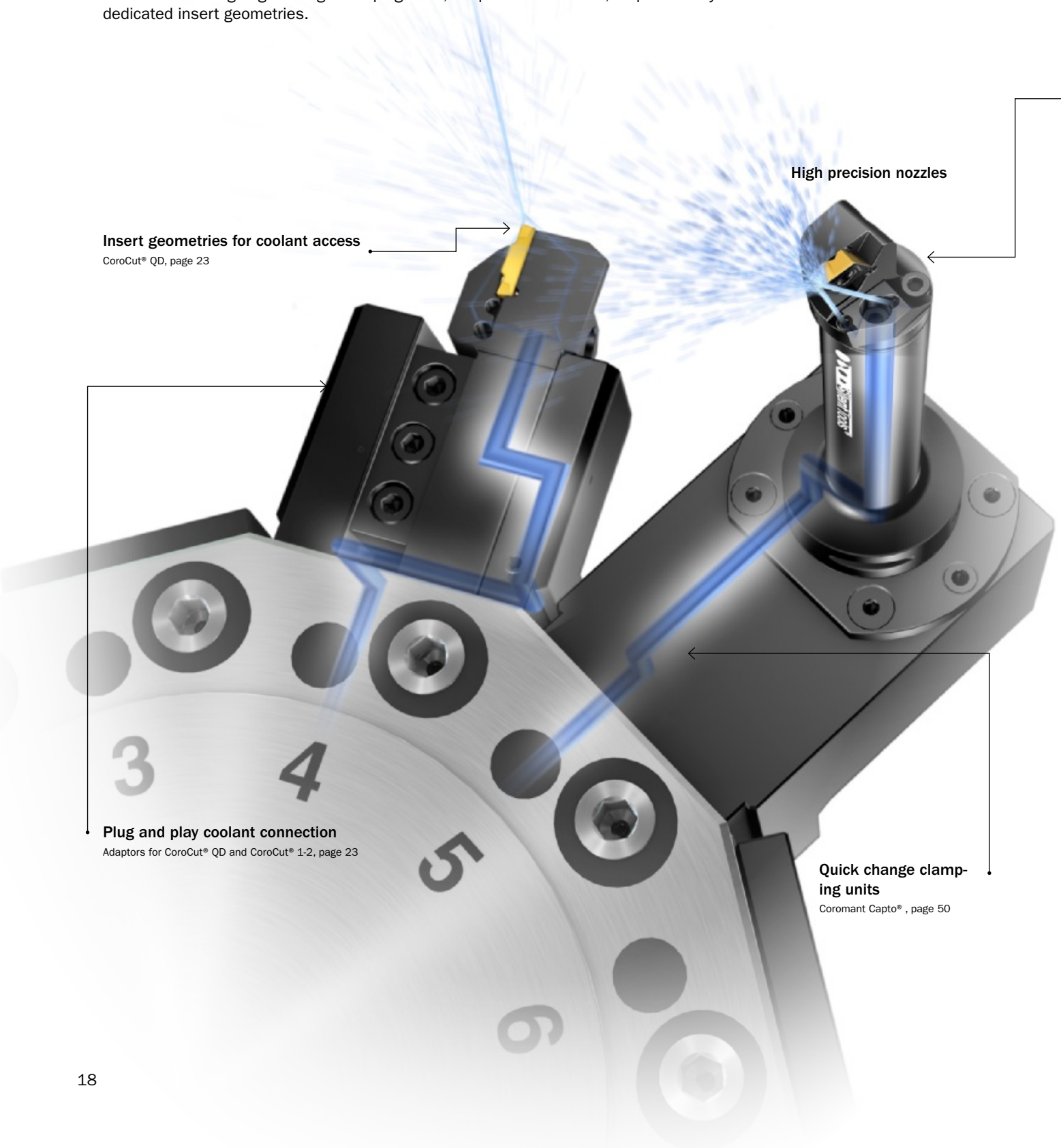

Insert geometries for coolant access

CoroCut® QD, page 23

High precision nozzles

Plug and play coolant connection

Adaptors for CoroCut® QD and CoroCut® 1-2, page 23

Quick change clamping units

Coromant Capto®, page 50

CoroTurn® SL cutting heads with CoroTurn® HP

Reliable chip evacuation

The CoroTurn HP high precision nozzles on the CoroTurn SL cutting heads put coolant pressure exactly where you need it, making the chips break which allows for good chip evacuation and long tool life. These cutting heads are also the perfect combination with Silent Tools™ in operations with long overhangs or vibration tendencies.



An extended offer of cutting heads for coolant pressure up to 150 bar (2200 psi):

- For back boring operations
- Clearance between tool body and component
- In sizes 25 and 40 mm
- For positive D- and V-style inserts
- Use with CoroTurn SL adaptors for internal coolant supply

For additional information see Supplement 14.1, chapter I.

3 bars, 3 heads = 9 combinations

The ingenious Serration Lock (SL) interface is extremely robust and lets you create a wide range of tool combinations from a small inventory.



CoroTurn HP – high precision coolant

The secret lies in the nozzles

CoroTurn HP's fixed, pre-directed high precision nozzles create parallel laminar jets of coolant with high velocity, directed at the right place of the insert edge. It is the precision and character of these jets that make the difference in terms of chip control and process security.

The positive effects start at low coolant pressure, but the higher the pressure is, the more demanding material can successfully be machined.

Bottle boring

– no longer a bottleneck

One of the most challenging operations for the aerospace and oil and gas industries is bottle boring, also called chamber boring, with long overhang in large turning centres.

The challenge is to keep vibration low and cutting data high without frequent and long production disruptions. Sandvik Coromant offers a unique combination of technology-leading products working together to create a complete solution, and helping you exceed your productivity goal.

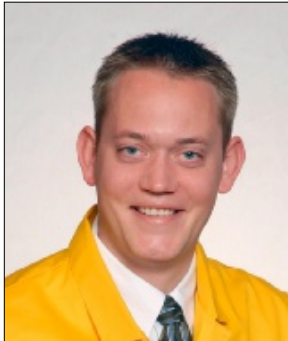

"This combination of tools is a powerful solution. Together they take care of the typical challenges you face in bottle boring, such as vibration, tool change time and clearance issues."

Jeffrey Westhoff
Productivity Engineer

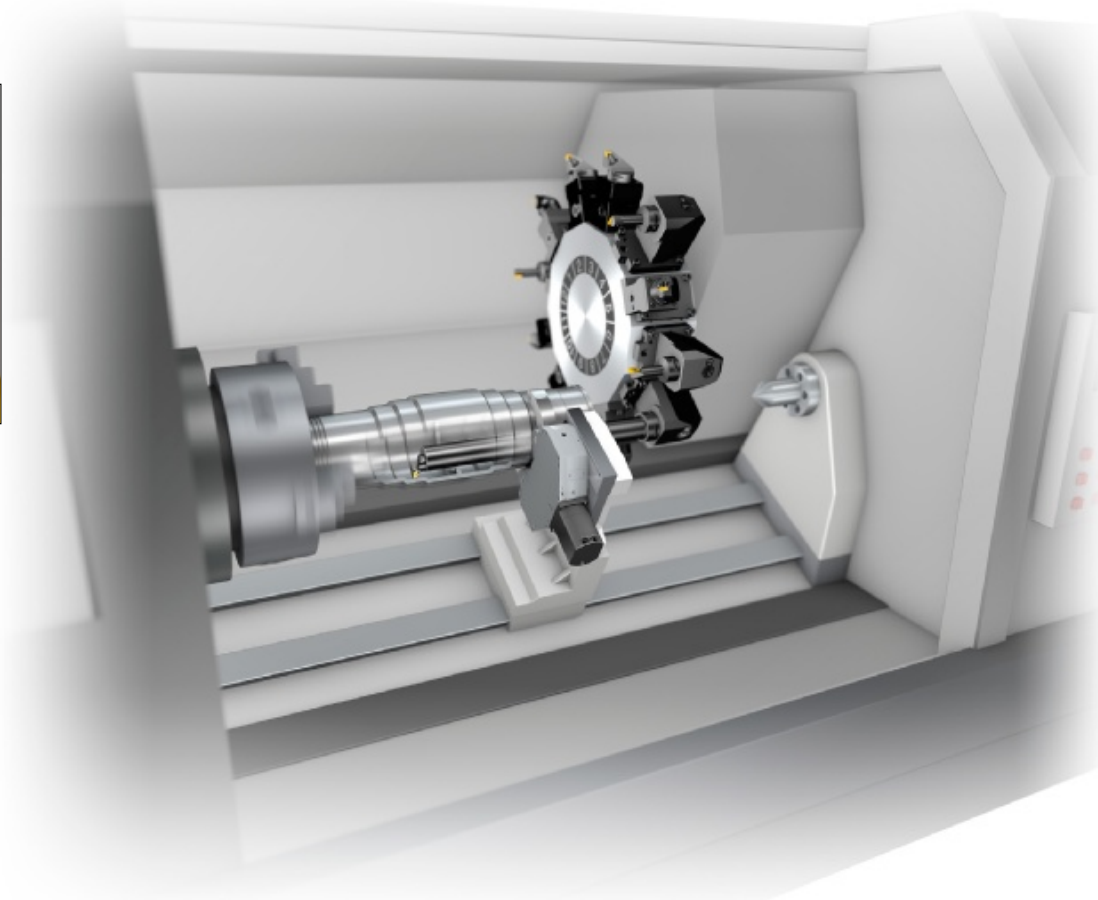

Typical components from the aerospace and oil and gas industries where bottle boring is a challenging operation



See the film



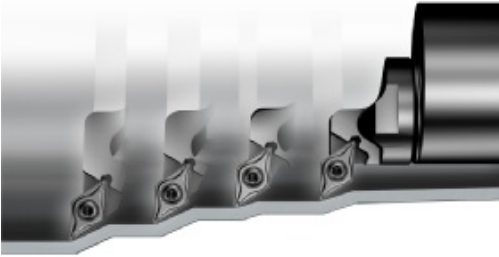

CoroTurn SL cutting heads have four stages of offset up to 23 mm (0.906 inch). This enables reach and largest possible boring bar diameter.

Making chips fly

Using high cutting data when having long overhang is challenging. To keep chips flying at a high rate, it is important to remove vibration and eliminate chip problems.

Silent Tools™ dampened boring bars stop vibration and the nozzle technology of CoroTurn® SL takes care of chip control. In this way, metal removal rate is kept up and the number of unplanned production interruptions down. Combine with insert grades GC4325 and GC4315 for predictable machining of steel components.

Shortest possible stops

Long boring bars left in the turning centre when they are not in use is a collision risk. Yet, taking the bar out of the machine usually takes time and hurts productivity. It might seem like a choice between two bad alternatives.

Well, who says you have to choose? Take the bar out, but in a quick and easy way using Coromant Capto® quick change clamping units. With tool change time under one minute you can avoid collisions and still keep your machine running.

An unbeatable combination

The combination of Silent Tools, CoroTurn SL with nozzle technology and quick change is a complete tooling solution for bottle boring with long overhang.

In a nutshell, you are able to perform a challenging operation with high total productivity on two levels: metal cutting efficiency and machine utilization.

More total productivity, see page 48



Silent Tools™

Dampened boring bars

www.sandvik.coromant.com

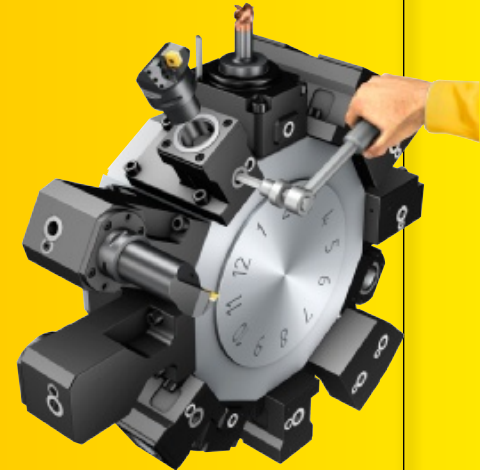

Coromant Capto®

Quick change clamping units

See page 50



CoroTurn® SL

Cutting heads with CoroTurn® HP

See page 19



GC4325 and GC4315

See page 8

CoroCut® QD

Reliable parting off

*Secure machining and
easy coolant connection*

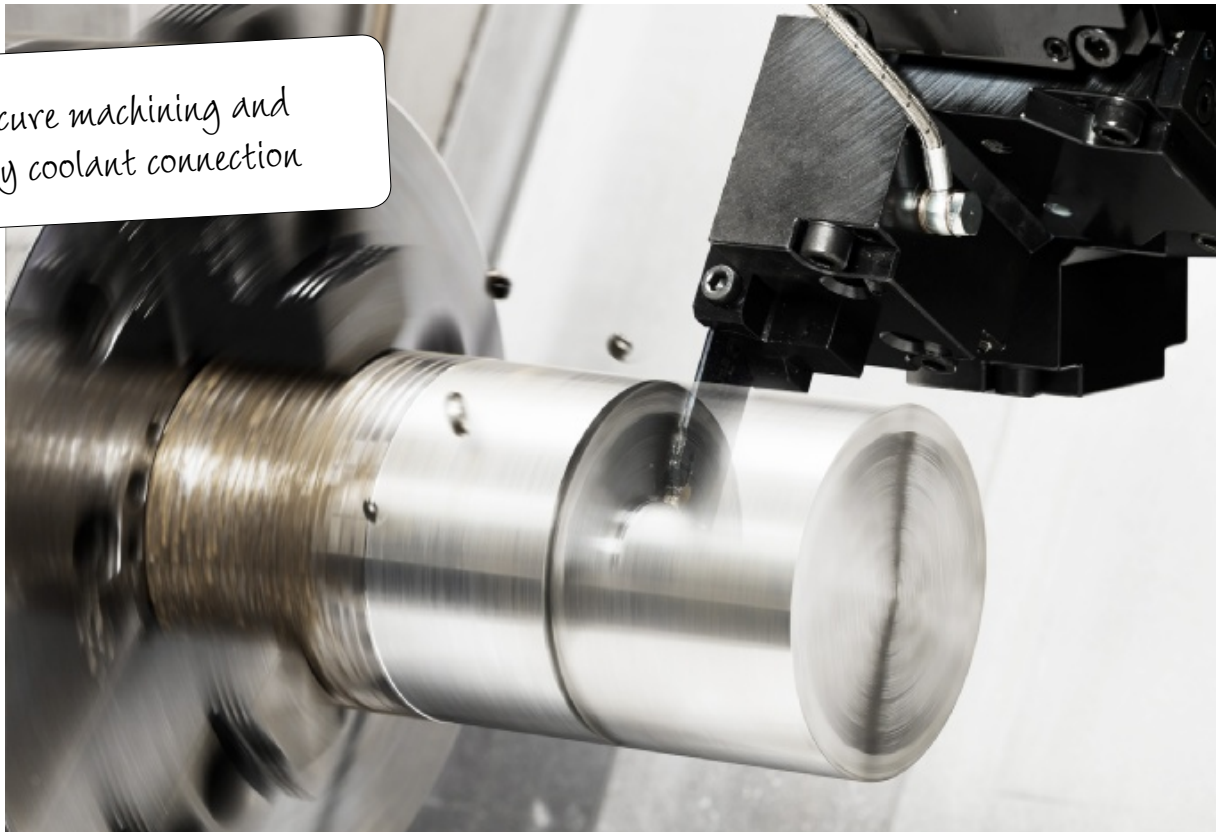

When you need to machine deep grooves or part off with long overhangs, CoroCut QD is the safest choice. All tools have over- and under coolant for best performance and chip control. Add the support from plug and play adaptors and a stable, user-friendly clamping mechanism and you get CoroCut QD – a system to rely on.

Benefits

- Secure machining
- Easy to connect coolant
- Easy to change insert
- Excellent surface finish with Wiper inserts
- Material savings thanks to narrow parting widths





ISO application area

Application

- Parting off
- Deep grooves and long overhangs
- Optimized for bar feed machines and sliding head machines

Technical features

High precision coolant

- Over- and under coolant available on all tools
- Easy coolant connection with plug and play adaptors
- Insert geometries for coolant access

Parting off inserts

- Insert grades with high edge-line security
- Chip breaking geometries
- Wiper inserts for great surface quality at high feeds

Strong tool material

- Material alloy with high fatigue resistance

Stable and user-friendly clamping

- No torque wrench needed – always correct clamping with quick-release key
- Rail insert seat ensures stable and precise insert position

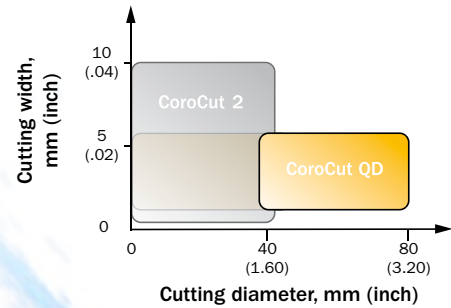

Assortment and performance on next page

Plug and play for easy coolant connection

For turning centres:

Coromant Capto®, HSK-T and VDI adaptors for connecting QS shanks and parting blades. Available for the most common machine tool interfaces.

QS™ holding system for sliding head machines:

QS stops are available for plug and play coolant connection of QS shanks and QS swiss tools.

For additional information see Supplement 14.1 chapter B.



QS (Quick Start): a system of tool holders, stops and wedges for quick change in sliding head machines.

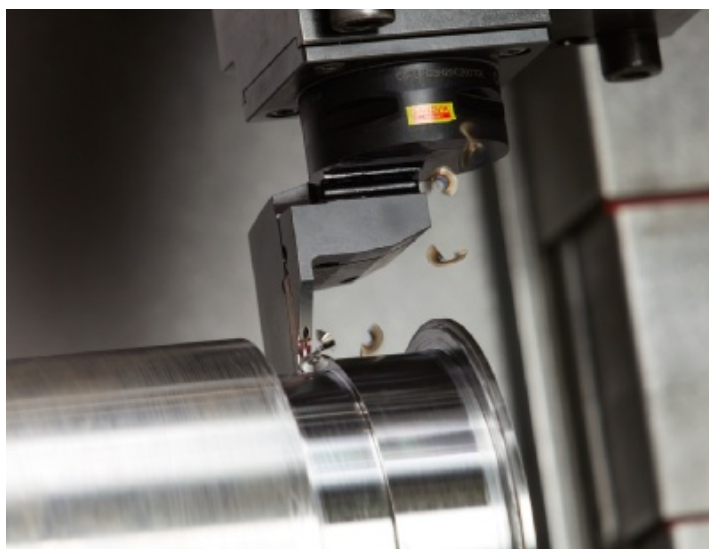

Assortment

Inserts

Application	Geometry	Grades	Seat size	Insert width, mm	Supplement 14.1
Parting, grooving - medium feed	-CM	GC1125, GC1135, GC1145	K	6.35	Chapter B
Parting, grooving - high feed	-CR	GC1125, GC1135, GC1145	K	6	Chapter B
Parting, grooving - low feed (sharp edge)	-CO	GC1105, GC1125, GC1135, GC1145	K	6	Chapter B
Grooving, turning - low-medium feed	-TF (Wiper)	H13A, GC1105, GC1125, GC1135, GC1145	K	6	Chapter B
Blanks for do-it-yourself grinding	-BG	H10F, H13A	K	8.4	Chapter B
Tailor made - grooving	-BG (Wiper)	H10F, H13A, GC1105, GC1125, GC1135, GC1145	K	6-8	Chapter B
Tailor made - parting, grooving	-CO (Wiper)	H10F, H13A, GC1105, GC1125, GC1135, GC1145	K	6-8	Chapter B

Wiper
TECHNOLOGY

The -TF, -BG and -CO geometries have Wiper design for excellent surface finish.

Tools

Coupling type	Coupling size, mm (inch)	Max cutting depth, mm (inch)	Cutting diameter, mm (inch)	Seat size	Supplement 14.1
Shank	3232 (20)	33-45 (1.30-1.77)	-	G, H, J, K	Chapter B
QS Shank	2020; 2525 (12;16)	26-40 (1.03-1.57)	52-80 (2.05-3.15)	G, H, J, K	Chapter B
QS Swiss	1010, 1212, 1616 (06, 08, 10)	13-20 (0.51-0.79)	26-40 (1.02-1.57)	E, F, G	Chapter B
Parting blades, neutral coupling, two insert seats	25, 45	60-80 (2.36-3.15)	-	G, H, J, K	Chapter B

Over- and under coolant on all tools

Adaptors for parting blades

Coupling type	Machine side interface, mm (inch)	Tool side interface	Supplement 14.1
Shank	3232, 4040 (20, 24)	45	Chapter H
HSK APBR/L (axial)	HSK 63T	25	Chapter H
Coromant Capto® APBA (radial)	C4, C5, C6, C8	25	Chapter H
Coromant Capto® APBR/L (axial)	C4, C5, C6, C8	25	Chapter H

Adaptors for QS shanks

Coupling type	Machine side interface, mm (inch)	Tool side interface, mm (inch)	Supplement 14.1
QS stop	2020, 2525 (12,16)	2020, 2525 (12,16)	Chapter H
HSK ASHR/L (axial)	HSK 63T	2525	Chapter H
Coromant Capto® ASHA/ASHR/L (radial/axial)	C5, C6, C8	2020, 2525	Chapter H
VDI ASHA (radial)	VDI 30, VDI 40	2020, 2525	Chapter H
VDI ASHR (axial)	VDI 25, VDI 30, VDI 40	2020, 2525	Chapter H

Plug and play adaptors

For additional information see www.sandvik.coromant.com

Average tool life

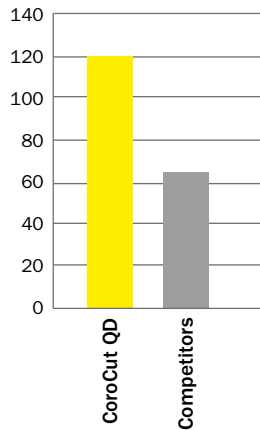

Outstanding tool life

Performance tests have been carried out at customer workshops worldwide.

- 91 tests against 16 competitors
- 78 percent won tests
- 85 percent average tool life increase

The test results gave a clear message – CoroCut QD gives outstanding performance in terms of tool life (number of components/edge).

Performance

Parting off tube with parting blade

Customer case	
Operation	Parting off tube, Ø50–38 mm
Workpiece material	Stainless steel, AISI 304, M1.0.Z.AQ (180 HB)
Tool	Parting blade, QD-NN2G60C25A
Insert	QD-NG-0300-0002-CM 1135

Cutting data	CoroCut QD	Competitor
Insert width mm (inch)	3 (0.118)	4 (0.0157)
Coolant	Internal, through	External
v_c m/min (ft/min)	255 (838)	191 (628)
f_n mm/r (in/rev)	0.10 (0.004)	0.08 (0.003)
Time in cut, sec/component	2.34	4.16

Results		
Tool life pcs	370	180
Tool life increase	106%	-

At higher cutting data and with 25% decreased cutting widths, CoroCut QD increased tool life with 106% while at the same time reducing the total cycle time.

Category	Tool Life (pcs)
CoroCut QD	370
Competitor	180

Parting off bar with parting blade

Customer case	
Operation	Parting off bar, Ø45 mm
Component	Shower mixer
Workpiece material	Super-austenitic stainless steel, M2.0.C.AQ (175 HB)
Tool	Parting blade, QD-LR1G33C25A
Insert	QD-NG-0300-0001-CO 1145

Cutting data	CoroCut QD	Competitor
v_c m/min (ft/min)	280 (918.6)	110 (361)
f_n mm/r (in/rev)	0.25 (0.010)	0.08 (0.003)
Time in cut, sec/component	0.25	0.37

Results		
Tool life, pcs	115	30
Tool life, increase	283%	-

The CoroCut QD insert had a nice wear while the competitor insert was completely worn out. The machine could also run for a longer time, providing for unmanned production.

CoroCut® 1-2

Rigid and rapid parting and grooving

New spring clamping for increased stability



With easily connected over- and under coolant on all tools, together with an extremely rigid and precise spring clamping mechanism, the updated CoroCut 1-2 now ensures truly secure and efficient parting and grooving.

Benefits

- Secure machining thanks to strong tool material and chip control
- High rigidity allows for increased feed rate
- Easy to connect coolant
- Easy to change insert

Application

- Grooving, profiling and parting



ISO application area

The CoroCut 1-2 system includes more than 700 standard inserts

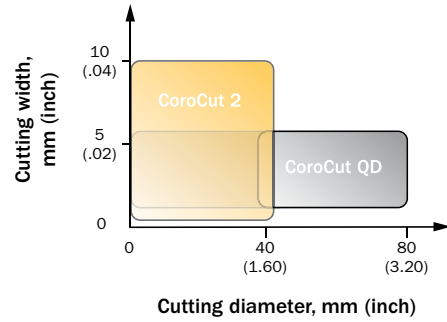

Technical features

Stable spring clamping

- Patented spring clamping for highest rigidity and clamping force accuracy
- Rail insert seat ensures stable and precise insert position
- No torque wrench needed – always correct clamping with quick-release key

High precision coolant

- Over and under coolant available on all tools
- Easy coolant connection with plug and play adaptors (see page 23)

Strong tool material

- Material alloy with high fatigue resistance



Performance

Screw clamping vs. spring clamping

Vibration deflection test

By applying a force (N) on the insert edge, the dynamic flexibility was measured at the vibration point, in terms of deflection per force unit (m/N).

Results	With spring	With screw
Deflection (m/N)	1.69×10^{-5}	4.56×10^{-5}
Enabled feed rate increase	27%	-

The test proves the high rigidity of the spring clamping system.

Theory confirmed in practice

Longitudinal turning operation tests have confirmed that the new rigid spring clamping allows for a feed rate* increase up to 27% with maintained deflection.

*Do not exceed cutting data recommendations for your insert. Also take machining conditions in consideration.

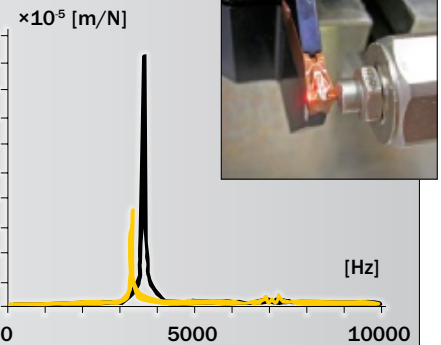

Assortment

Tools

Coupling type	Coupling size	Max cutting depth, mm (inch)	Cutting diameter, mm (inch)	Insert seat size	Supplement 14.1
Coromant Capto®	C3–C8	15–32 (0.59–1.26)	-	E, F, G, H, J, K, L, M	Chapter B
QS Shank	2020, 2525 (12, 16)	15–32 (0.59–1.26)	30–64 (1.18–2.52)	E, F, G, H, J, K, L, M	Chapter B
Shank	3232 (20)	25–32 (0.98–1.26)	26–40 (1.02–1.57)	K, L, M	Chapter B

Adaptors for QS shanks, assortment on page 24

For additional information see www.sandvik.coromant.com

Equipped for secure machining

How can you meet the demands on high security in parting and grooving operations?
By combining reliable tools with rigid clamping and efficient coolant supply.

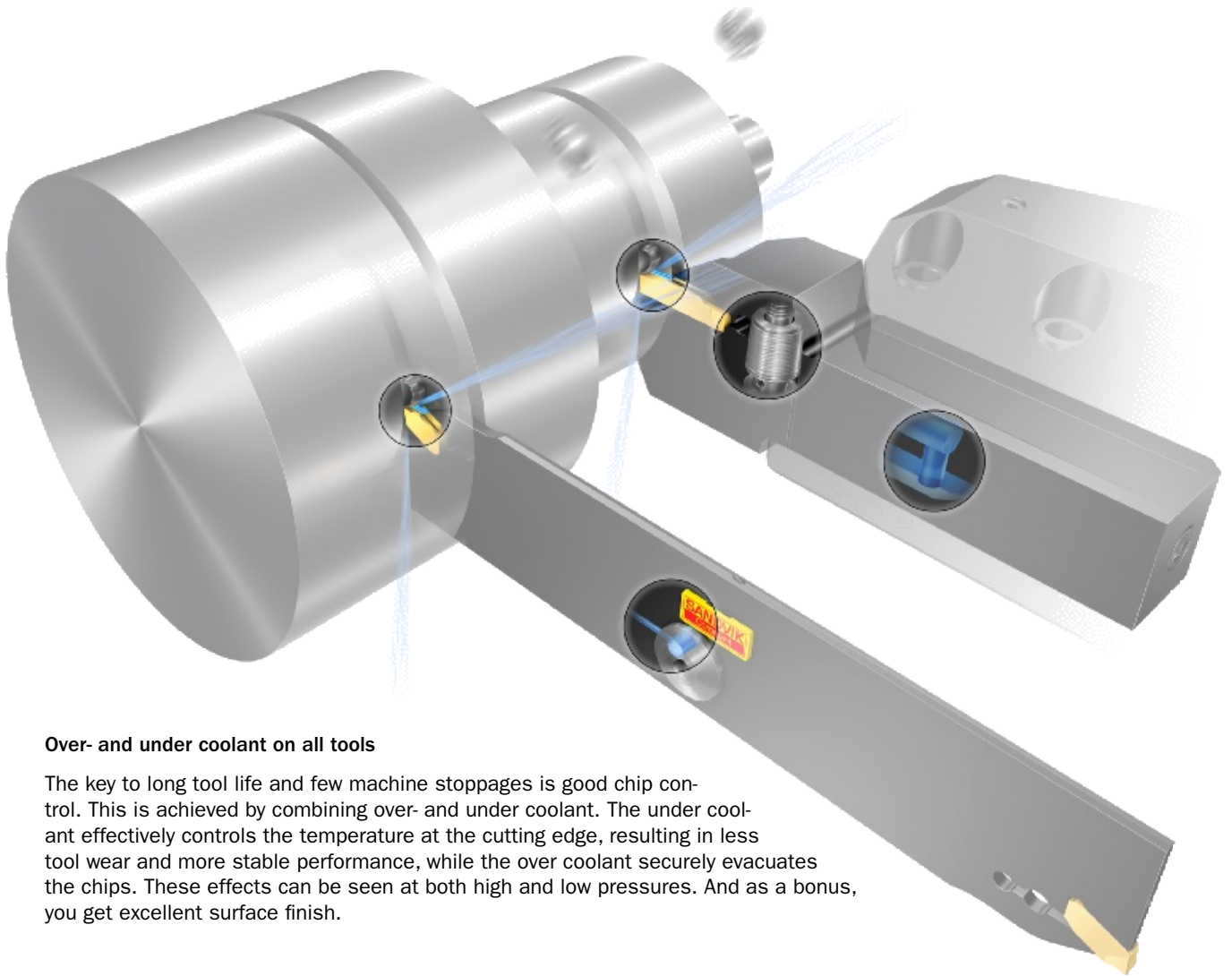

Over- and under coolant on all tools

The key to long tool life and few machine stoppages is good chip control. This is achieved by combining over- and under coolant. The under coolant effectively controls the temperature at the cutting edge, resulting in less tool wear and more stable performance, while the over coolant securely evacuates the chips. These effects can be seen at both high and low pressures. And as a bonus, you get excellent surface finish.

See the film



No need for coolant hoses with plug and play

Connecting the coolant to the tool can be time-consuming and tricky due to poor access and hoses being in the way of tools and component. Adaptors with plug and play function eliminate the need for a hose, for a trouble-free coolant connection and tool change.

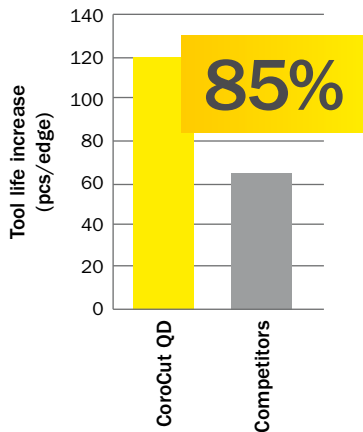

Inserts that last

At the edge the cutting forces are high. The insert geometries of CoroCut® QD are carefully designed for good chip forming, high security and good coolant access. Together with grades that provide excellent edge-line security in all materials, there is an insert that excels in every parting off operation.

Rigid clamping prevents tool breakage

Worn out insert seats lead to instability and damaged tools. To prevent this, the new insert clamping has a quick-release key. This offers high clamping accuracy and stability which ensures that the seat will not wear down when the insert is indexed. Together with a rail insert seat for optimal stability and fatigue resistant tool material, the risk of tool breakage is significantly reduced.

CoroCut 1-2 patented spring clamping is extremely rigid and allows for up to 27% increased feed rate, see page 27.

The importance of easy clamping

Then again, no matter how resistant the inserts are, they will eventually wear out. Therefore the new CoroCut focuses not only on high security but also easy handling. The new clamping solution has a railed insert seat and a quick-release key that eliminates the need of a torque wrench. This guarantees not only good stability and correct clamping force, but also a smooth insert change.

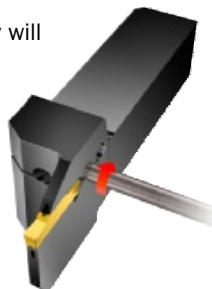

CoroCut® QD

See page 22



CoroCut® 1-2

See page 26



Adaptors for easy coolant connection

Coromant Capto®, VDI, HSK and QS™ holding system

See page 23

Did you know?

Sandvik Coromant offers the largest standard assortment of parting and grooving tools on the market.

CoroMill® 345

Face milling in stainless steel

Low cutting forces



Stainless steel milling often involves difficulties with chip formation, surface finish, tool life and productivity. To successfully overcome these kinds of challenges you need low cutting forces. The light cutting action of the new CoroMill 345 inserts gives you precisely that. In addition, this makes the cutter a good choice for weak fixtures and small-spindle machines, such as ISO 30.

Benefits

- Good chip formation in stainless steel
- Low cutting forces make the tool possible to use in weak machines and fixtures
- Operator-friendly working environment thanks to soft machining sound
- Great surface finish

Application

- Face milling in stainless steel
- Roughing to finishing
- Diameter range 40–250 mm (1.5–10 inch)
- The new geometries for stainless steel can also be used as a problem-solver for steel, in vibration-sensitive applications or weak fixtures



ISO application area

Technical features

Inserts with eight cutting edges

Internal coolant available for cutters up to diameter 125 mm (5 inch)

Wiper TECHNOLOGY
Wiper inserts available for brilliant surface finish

New shim replaces the previous one*



New light-cutting geometries for excellent performance in stainless steel



Performance

Customer case

Component	Pump body
Operation	Dry roughing
Workpiece material	Stainless steel 316L, M1.0.Z.AQ
Machine	Horizontal machining centre
Tool and insert	345-063Q22-13M and 345R-13T5E-MM

Cutting data

	CoroMill 345	Competitor
v_c m/min (f_t /min)	220 (722)	180 (591)
f_z mm/z (in/z)	0.25 (0.01)	0.25 (0.01)
a_p mm (inch)	3 (0.118)	3 (0.118)
v_f mm/min (in/min)	1388 (54.6)	1136 (44.7)
z	5	5

Results

Tool life (pcs/edge)	3	2
Tool life (min)	33.4	27
Worn out	No	Yes

CoroMill 345 produced 50% more components with 22% higher metal removal rate than the competitor, without wearing the inserts out.



Assortment

Insert product code	Shim product code*	Geometry	Operation type	Supplement 14.1
345R-13T5E-ML	5322 474-01	E-ML	Light	Chapter D
345R-13T5E-MM	5322 474-01	E-MM	Medium	Chapter D
345R-13T5M-MM	5322 474-01	M-MM	Medium	Chapter D
345N-13T5E-MW8	5322 474-01	E-MW8 (Wiper)	Light	Chapter D

*The new E-ML, E-MM, M-MM, and E-MW8 geometries cannot be used in combination with the previous shim (product code 5322 472-04). All previously introduced geometries fit both the previous and the new shim.

For additional information see www.sandvik.coromant.com



5322 474-01
5322 472-04

CoroMill® 495

Versatile chamfer cutter

One solution – many chamfers



Most components require at least one chamfer operation. This makes frequent tool changes a potential problem, especially when machining small batches in different materials. With CoroMill 495, the same tool can perform multiple kinds of chamfering in several materials, ideal for keeping downtime low and machine utilization high.

Benefits

- Versatile tool for many different chamfer operations
- Flexible inserts capable to perform in several workpiece materials
- High machine utilization thanks to few tool changes

Application

- Chamfering of holes and along edges
- Typical operations are chamfers, back chamfers, preparation for welding and deburring



ISO application area



Technical features

- Indexable inserts with four cutting edges
- Grades and geometries with wide-range functionality in several workpiece materials
- Cutter bodies with high number of inserts in relation to body size



Assortment

Cutter bodies

Cutter diameter	Chamfer angle	Coupling type	Supplement 14.1
12–25 mm	15°, 30°, 45°, 60°	Cylindrical shank	Chapter D
0.5–1 inch	15°, 30°, 45°, 60°	Weldon	Chapter D
12–25 mm	45°	Coromant EH	Chapter D
40–63 mm	45°	Coromant Capto®	Chapter D

Inserts

Insert product code	Grade	Geometry	Insert size	ISO application area	Supplement 14.1
495-09T3M-PM	GC1030	-PM	09	P, K, N	Chapter D
495-09T3M-MM	GC1040	-MM	09	M, S	Chapter D

For additional information see www.sandvik.coromant.com

Tailor Made end mills for aluminium

Do you require a specific corner radius or have a component with features that are difficult to reach? With our new Tailor Made offer for CoroMill Plura cutters for ISO N materials you can easily customize solid end mills to fit your specific needs. Finding the perfect tool for your aluminium or thermoplastic component has never been easier.

Tailored to your needs

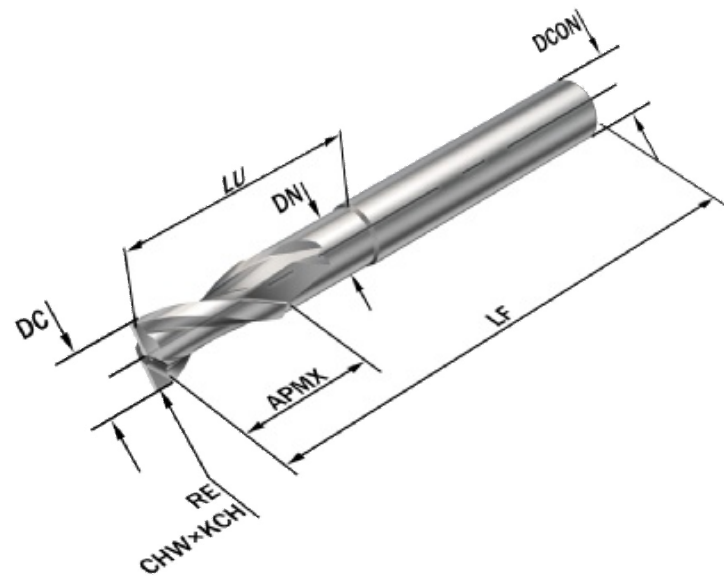

Application

Roughing to finishing and super-finishing in aluminium and thermoplastic

- Slotting
- Shoulder milling
- Profiling



ISO application area

Common challenges, typically found in the aerospace industry:

Challenges	Tailor Made solutions
Vibration and stability	Optimize the tool length (LF) to keep overhang to a minimum
Inadequate clearance	Modify usable length (LU) to provide sufficient clearance between workpiece and tool
Specific corner radius	Adjust the tool's corner radius (RE) to meet your component's requirements



Quotation within 24 hours.
Delivery within 10 days.

Benefits

- Modify the tool to fit your specific needs and challenges
- Easy ordering and short delivery time
- Use our outstanding cutting geometry for your customized tool
- Long tool life at high material removal rate



CoroMill® Plura New brazed PCD cutters

Milling cutters for edging in Carbon Fibre Reinforced Plastic (CFRP), common in the aerospace industry.

- Durable tool with predictable wear
- Reconditioning possible
- Diameter range 6–16 mm (1/4–5/8 inch)
- With internal coolant
- Five-degree ramping capability



See chapter D, Supplement 14.1

Thread milling cutters

Our small thread milling cutters for internal threads are ideal when machining time-consuming, expensive components and secure performance is important. If you want threading with no risk of tap breakage or damaged components, these small thread milling cutters are the perfect choice for you.

Avoid scrapped components



Application

- Small part machining
- Threads from diameter M1.6, no. 1–64 UNC and no. 2–56 UNF, common in medical components
- Internal right- and left-hand threading



ISO application area

Assortment

Thread form	Range	Depth	Grade	ISO application area	Supplement 14.1
M	M1.6–M12	2xD	GC1620	P, M, K, N, S	Chapter D
M	M2–M6	2xD	GC1610	H, P	Chapter D
M	M1.6–M8	3xD	GC1620, H07F	P, M, K, N, S	Chapter D
UNC	No. 1–5/16	3xD	GC1620	P, M, K, N, S	Chapter D
UNF	No. 2–5/16	3xD	GC1620	P, M, K, N, S	Chapter D

For additional information see www.sandvik.coromant.com

Benefits

- Secure threading with no risk of damaged components due to tap breakage
- High machine utilization – good chip breaking and no chips tangling around the tool
- Reliable threading in hardened materials up to 63 HRC



Hole science

The tool solutions for holemaking – drills, reamers and taps – are well established since many years now. However, today's products have evolved considerably: high-technology substrate materials, advanced cutting-edge designs and flute developments are among the features that have taken Sandvik Coromant to new frontiers. Advances in research and development together with new manufacturing processes have delivered superior technologies, unthinkable a decade ago. With a complete range of drills, taps and reamers our holemaking offer now exceeds all expectations.

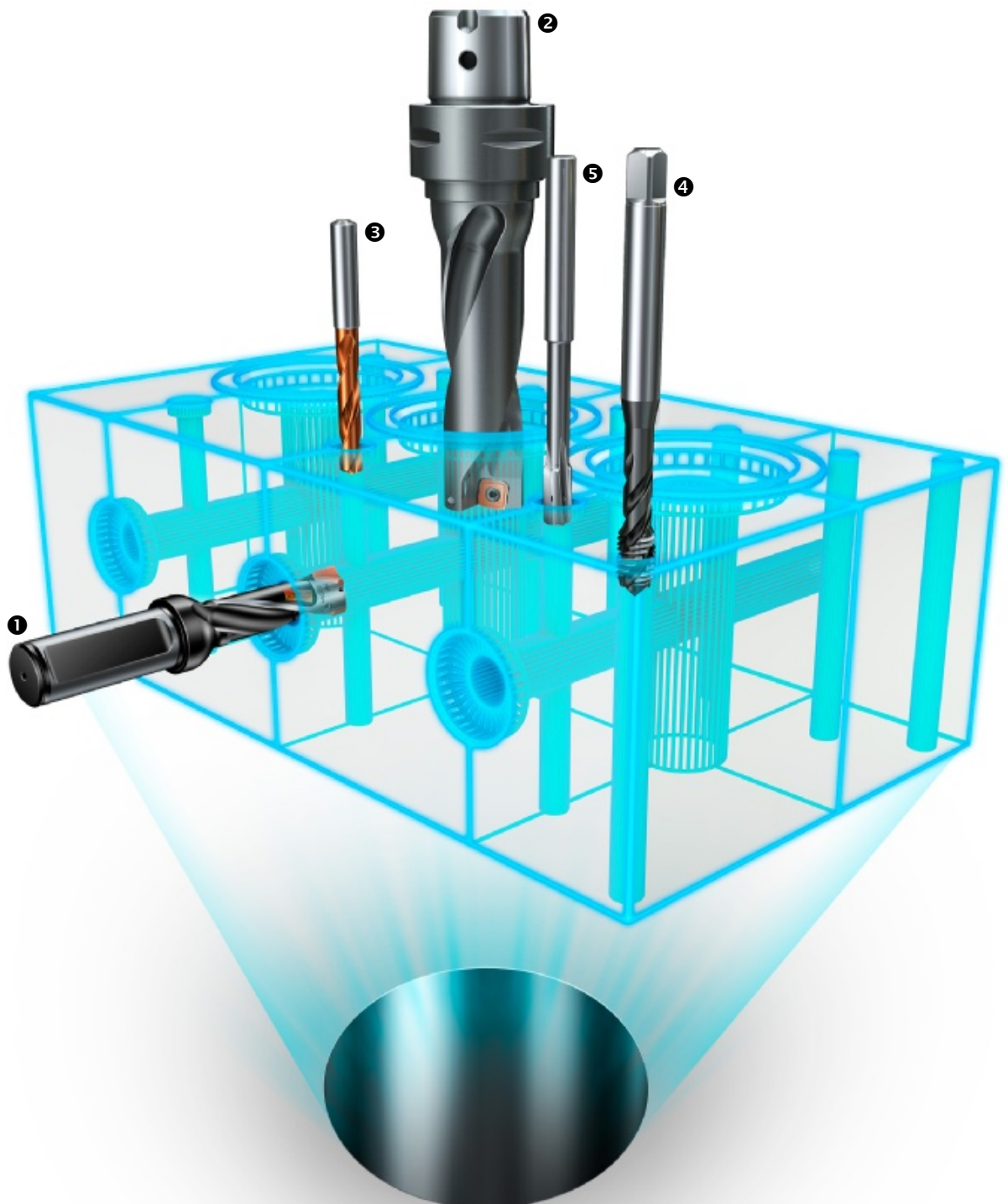

See the film





Meeting your challenges

Drilling and tapping are often critical operations carried out late in the production cycle when the component value is high. The demands on the cutting edge are high due to chip evacuation, particularly at drilling depths above five times the diameter. With our unique designs of inserts, drills, taps and reamers, we are able to increase productivity and achieve the crucially required hole demands in a secure way.

- ❶ **Exchangeable-tip drills** offer high process security with safe chip evacuation for medium-fine tolerance holes. Optimized grades and geometries for various materials increase tool life and penetration rates.
- ❷ **Indexable insert drills** designed for productive drilling are optimized for medium-coarse tolerance applications in all workpiece materials.
- ❸ **Solid carbide drills** feature a complete offer for fine tolerance holes and deep bores. To further improve productivity and cost per hole, all solid carbide drills from Sandvik Coromant can be reconditioned to their original specification.
- ❹ **Taps** designed for high performance are available for all materials and in a multitude of variants. They ensure high quality, economical threading through reduced machine downtime and long tool life.
- ❺ **Reamers** in solid carbide are the right solution when high surface quality and finish, combined with extra close hole tolerance are required. With dedicated geometries and internal coolant, they deliver superb hole quality.

Pick the right product!

Many factors influence the success of your drilling and tapping operations – materials, tolerances, surface quality, chip evacuation, coolant, tool holding and applications. Smart choices maximize each step of the production process to ensure improved hole quality and a lower cost per hole. For guidance, visit our web page www.sandvik.coromant.com or contact your local Sandvik Coromant representative.

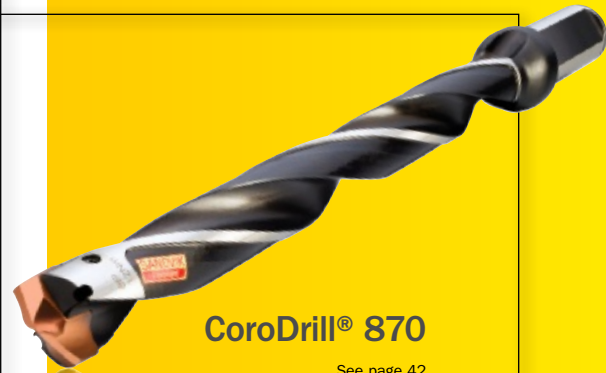

CoroDrill® 870

See page 42



CoroDrill® 880

www.sandvik.coromant.com

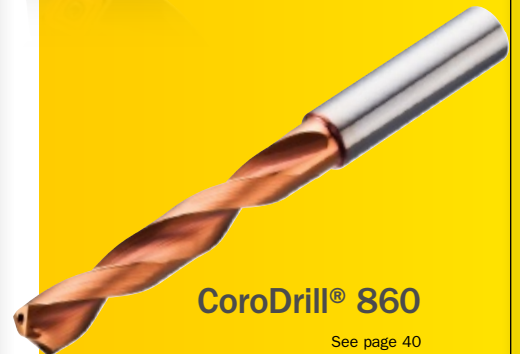

CoroDrill® 860

See page 40



CoroTap® XM

See page 44



CoroReamer™

www.sandvik.coromant.com

CoroDrill® 860 -MM

Solid carbide drills for stainless steel

Our most advanced drill for stainless steel ever!



CoroDrill 860 is a solid carbide drill optimized for drilling in stainless steel. With a higher cutting-speed capability, it provides an unbeatable combination of penetration rate and precision. This drill demonstrates the best process security on the market. Choose CoroDrill 860 for high-performance drilling in all ISO-M materials.

Benefits

- Secure, stable and reliable drilling
- Consistent hole quality
- Maximum productivity in ISO-M materials thanks to high performance drill geometry
- Long tool life with predictable wear
- High penetration rates for improved productivity

Application

- Austenitic, super austenitic, ferritic and duplex stainless steels
- Drill diameter range: 3–16 mm (0.118–0.629 inch)
- Drill lengths: 3, 5, 8 × drill diameter
- Hole tolerance: IT 6–IT 8
- Typical components: valves, flanges, tubes, heat exchangers, shafts



ISO application area

Technical features



New chisel geometry to improve tool centring, hole quality and reduce margin damage for long tool life

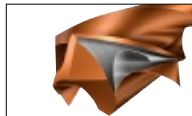

TiN/TiAlN multi-layer coating and wet blasting post treatment improve surface finish and reduce friction



Unique geometry optimized for secure chip control in stainless steel

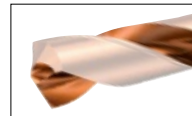

Increased flute volume for improved chip evacuation

Tailor Made



Available as Tailor Made in intermediate sizes up to 20 mm (0.787 inch). 4 weeks leadtime.

Performance

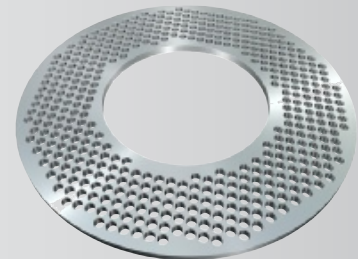
Customer case		
Workpiece material	Ferritic and martensitic stainless steel, P5.0-5.1	
Application	Through hole (11 mm) in extrusion ring (550 holes/component)	
Hole diameter, depth mm (inch)	5.0 (0.197) 3×D	
Coolant	Emulsion 9%, 15 bar	
Drill	860.1- 0500-015A1-MM 2214	
Cutting data		
<i>n</i> (rpm)	CoroDrill® 860	Competitor
	7640	3820
<i>v_c</i> m/min (ft/min)	120 (393)	60 (197)
<i>f_n</i> mm/r (in/rev)	0.10 (0.004)	0.07 (0.003)
<i>V_f</i> mm (inch)	764 (30.08)	267 (10.5)
Results		
Drilled length m (ft)	CoroDrill® 860 -MM 3×D	Competitor
	48.4 (159)	18.1 (59)
Number of components	8	3
Tool life increase	167%	–
Productivity increase	186%	–
<p>CoroDrill 860 ran near 3 times faster than the competitor and achieved more than 2.5 times the tool life.</p>		



Assortment

Drill type	Length (×DC)	Standard	Drill diameter mm (inch)	Coolant	Geometry	Shank type	Grade	Supplement 14.1
 Standard single diameter drills	2–3	DIN 6537 K	3.0–16.0 (0.118–0.630)	Yes	-MM	DIN 6535 HA	GC2214	Chapter E
	4–5	DIN 6537 L	3.0–16.0 (0.118–0.630)	Yes	-MM	DIN 6535 HA	GC2214	Chapter E
	7–8	Sandvik Coromant	3.0–16.0 (0.118–0.630)	Yes	-MM	DIN 6535 HA	GC2214	Chapter E
 Step and chamfer drills	2–3	DIN 6537 K	3.35–17.5 (0.132–0.689)	Yes	-MM	DIN 6535 HA	GC2214	Chapter E

For additional information see www.sandvik.coromant.com

CoroDrill® 870

Now for deeper holes and larger diameters

*Reliable holemaking
for high productivity*

Our existing CoroDrill 870 offer is now extended to include exchangeable-tip drills for deeper holes and larger diameters. When drilling deep holes – process security is the main focus. The cutting edges and the flute design of CoroDrill 870 allows for excellent chip evacuation, aiming for a secure and reliable process.



Benefits

- Secure and reliable cutting process
- Easy handling and safe tip changing
- Long predictable tool life at high productivity
- Optimized chip control and evacuation
- Low cost per hole and excellent hole quality

Application

- Hole depths up to 10 × drill diameter
- Hole diameter range: 10.00 to 33.00 mm (0.394–1.299 inch)
- Hole tolerance: H9–H10



ISO application area

Technical features

- Geometries and grades optimized for steel, cast iron and stainless steel
 - Grades with predictable wear for long and reliable tool life at high cutting data
 - Geometries for high process security, good chip control, high penetration rates and premium hole quality
- Drill flutes with optimized shape, size and helix angle for safe chip evacuation and good tool stability



- Easy tip changing while tool is in the machine for reduced downtime
- Secure, high-precision interface between drill body and tip for extra stability

Recommendations

For best possible hole quality, before drilling holes deeper than six times the drill diameter, it is recommended to first drill a pilot hole with a short CoroDrill 870 using the -GP geometry.

Assortment

Drill bodies

Diameters with drill tip mounted, mm (inch)	Shank type	Length (×DC)	Supplement 14.1
10.00–33.00 (0.394–1.299)	Cylindrical with flat according to ISO 9766 (mm and inch)	3, 5, 8	Chapter E
10.00–26.99 (0.394–1.063)	Cylindrical with flat according to ISO 9766 (mm and inch)	10	Chapter E

Drill tips

Diameter, mm (inch)	Geometry	Grade	Supplement 14.1
10.00–33.00 (0.394–1.299)	-PM	GC4234	Chapter E
10.00–33.00 (0.394–1.299)	-MM	GC2234	Chapter E
10.00–33.00 (0.394–1.299)	-KM	GC3234	Chapter E
10.00–33.00 (0.394–1.299)	-GP	GC4234	Chapter E

For additional information see www.sandvik.coromant.com

CoroTap™ -XM

Tapping in multiple materials

Easy choice for secure tapping



CoroTap -XM is an easy to choose, multi-functional tapping solution for a wide range of materials. Depending on your demands, there are three different grade options to meet your requirements. All options are suitable for most materials and ensure great machine utilization.

Benefits

- Suitable for a wide range of materials
- Reduces tool inventory and minimizes costs
- Provides long consistent tool life
- Offers a stable machining process due to unique cutting geometry

Application

- For through- and blind holes
- Depths up to 2.5 × diameter
- Chamfer E for short clearance in blind holes
- Threading up to 350 HB
- Suitable for all industrial segments

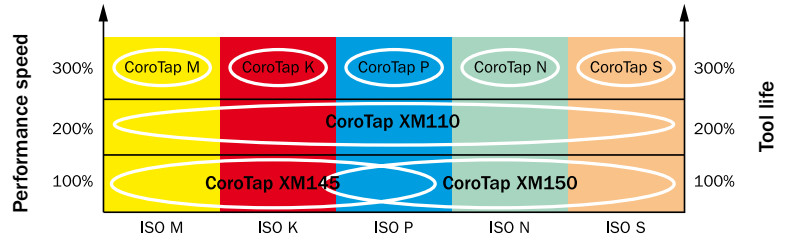

Technical features

- The spiral flute design secures a constant rake angle for a continuous cutting process
- High spiral angles ensure excellent chip evacuation and enable threading up to 2.5 × diameter in blind holes

Different grades:



C150/B150 (uncoated) bright clean surface for reduced adherence in soft materials



C145/B145 (steam tempered) oxidated layer for surface protection and prevention of build-up edge



C110/B110 (coated) with high wear- and heat resistance for long tool life and high cutting speeds

Assortment

Thread form	Range	Tolerance	BSG	CoroTap	Grade	Supplement 14.1
M	M3–M24	6H	DIN	T200/T300	C150, C145, C110, B150, B145, B110	Chapter F
M Form E	M3–M20	6H	DIN	T300	C150, C145, C110, B150, B145, B110	Chapter F
MF	M8–M20	6H	DIN	T200/T300	C150, C145, C110, B150, B145, B110	Chapter F
UNC	No. 4–1	2B	DIN	T200/T300	C150, C145, C110, B150, B145, B110	Chapter F
UNF	No. 8–1	2B	DIN	T200/T300	C150, C145, C110, B150, B145, B110	Chapter F

For additional information see www.sandvik.coromant.com

Deep hole machining

- new technology and updates that make a big contribution

High material-removal rates and accuracy are the defining characteristics when it comes to deep hole machining. Hole straightness, dimensional tolerances and surface finish are important as well. With so many critical factors, process security is a great concern in the majority of deep hole machining operations.

Challenge: security

When machining long components on the STS, operators face a number of challenges. Manually adjusting the clamping unit on the vibration damper is one of them. When a big workpiece is rotating – manual clamping adjustment is not an easy procedure. It is also hard to get it right instantly due to the precision required. Moreover, it creates a risk for personal injury.

Solution: remote control

The new vibration damper helps to maintain stable production process, making it secure with a remote controlled adjustment unit. It allows operators to step away from machines and manage adjustment without hand tools, eliminating the risk of personal injury. It also dampens machining noise and creates excellent precision, which adds to good surface finish. When vibration is under control, excessive tool wear is no longer a problem. Result: safe working environment and increased machine utilization.

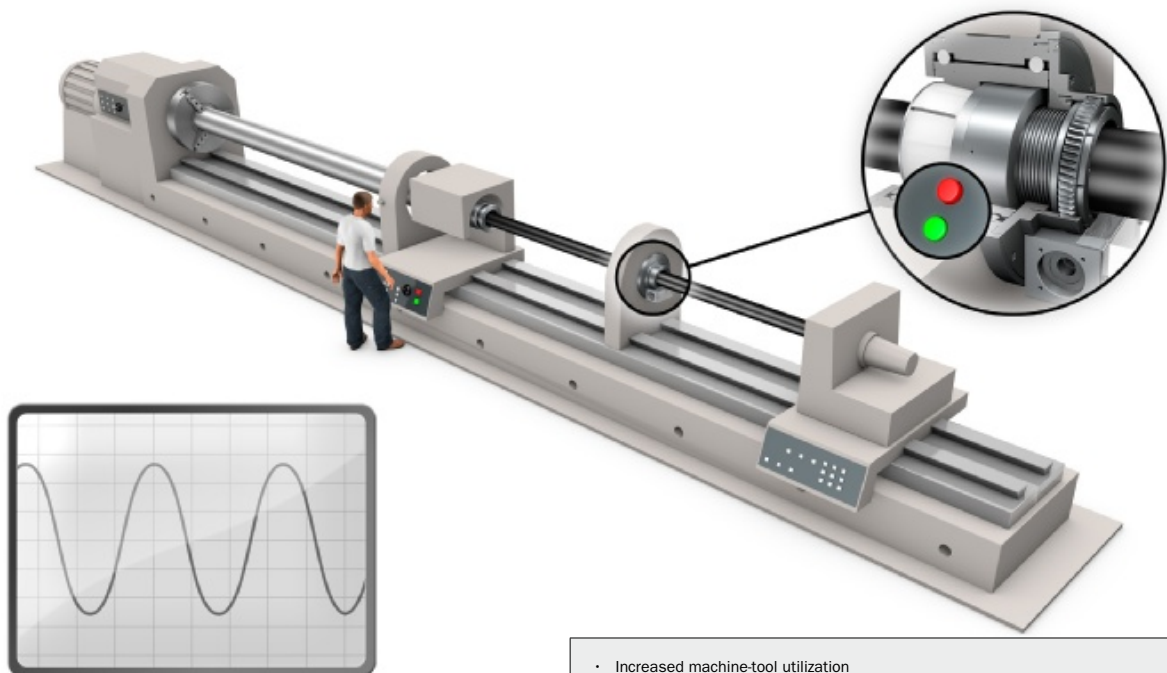

- Increased machine-tool utilization
- Secure working environment
- Bi-directional functionality for pull- and push applications
- Excellent vibration precision
- Self-locking unit in case of electricity loss



New geometry for excellent chip formation

In deep hole machining, a combination of tool design and cutting fluid pressure is used to flush the chips out of the hole. **CoroDrill® 800** new central insert L-geometry gives an excellent chip formation and evacuation. Now a complete assortment of inserts and geometries for CoroDrill 800 and CoroDrill 801 is available.

More information in Supplement 14.1, chapter F.

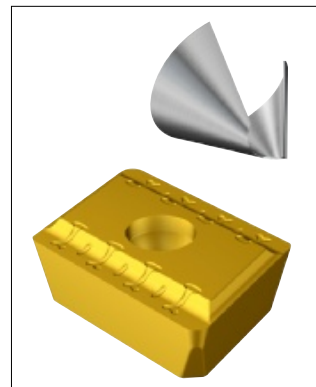

New L-geometry

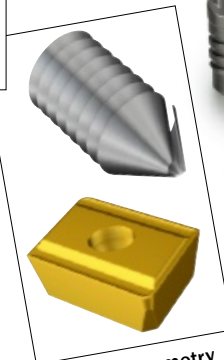

Previous geometry



Stock-standard program

Brazed carbide gun drills are the basic choice when drilling deep in all materials. These user-friendly, regrindable drills require no pre-setting. Available as a stock-standard program.

- Diameter range 0.07–1.000 inch
- Hole tolerance: IT 9



TPGX inserts, featuring four different grades, profiles and sizes, are now available globally. These versatile inserts with i-Lock technology are designed for a secure insert positioning.

- G- and L-geometry options
- Right- and left hand style



Winning the productivity race

With productivity, much like in a car race, both having high speed and keeping stops few and short are important. We build strong teams with our customers and develop productivity-enhancing solutions based on their challenges. Depending on the situation, total productivity can be enhanced by increasing metal cutting efficiency or machine utilization. Or in some situations – both.



Machine utilization – more machining time!

Keeping planned stops short is a true productivity booster. Manual tool change is time-consuming and sometimes really tricky, especially when using machines with limited space or when tool position is not repeatable. In the worst case, it can take up to 10 minutes to get the tool in place and the position right.

For the pit stop: quick change with Coromant Capto® and QST™ holding system.



Unplanned stops are real time thieves.

A flat tire destroys your chances at winning in a car race. Similarly, chip problems and tool breakage can really damage efficiency in a workshop.

To keep you on the track: GC4325, GC4315, CoroTurn® HP and Silent Tools™.



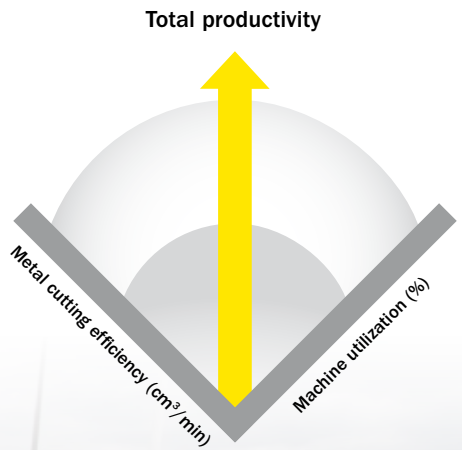
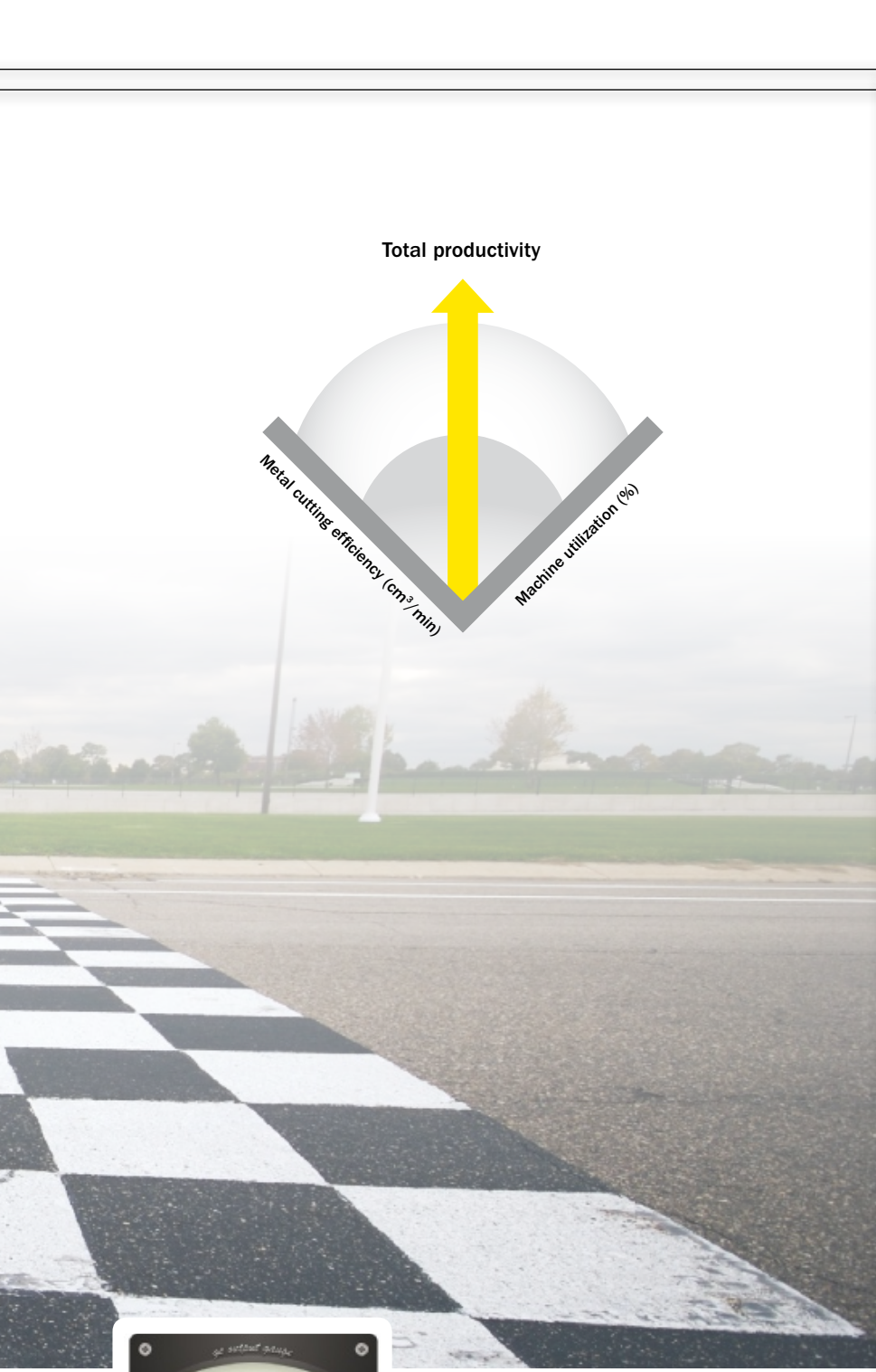

Metal cutting efficiency – go fast!

Metal cutting efficiency is all about speed and high chip removal rate. Still, increasing speed with the downside of frequent stops is not efficient.

To reach high productivity, you need high-performance grades, rapid methods and to not let vibration slow you down.

For high speed: GC4325, GC4315 and Silent Tools™.



GC4325 and GC4315

See page 8

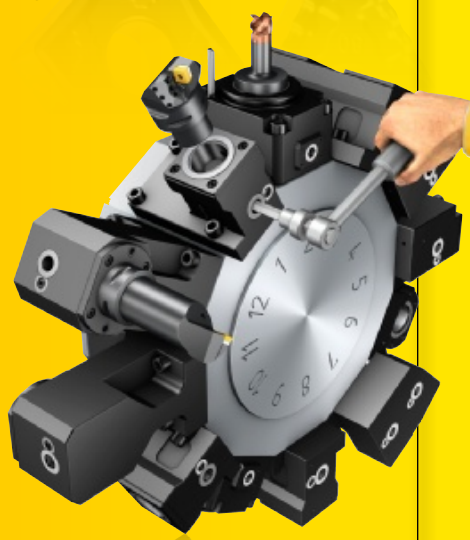

Quick change

Coromant Capto® clamping units

See page 50

QS™ holding system

See page 23



CoroTurn® HP

High precision nozzles

See page 19



Silent Tools™

Dampened boring bars

www.sandvik.coromant.com

Coromant Capto®

Quick change clamping units

Maximized machining time

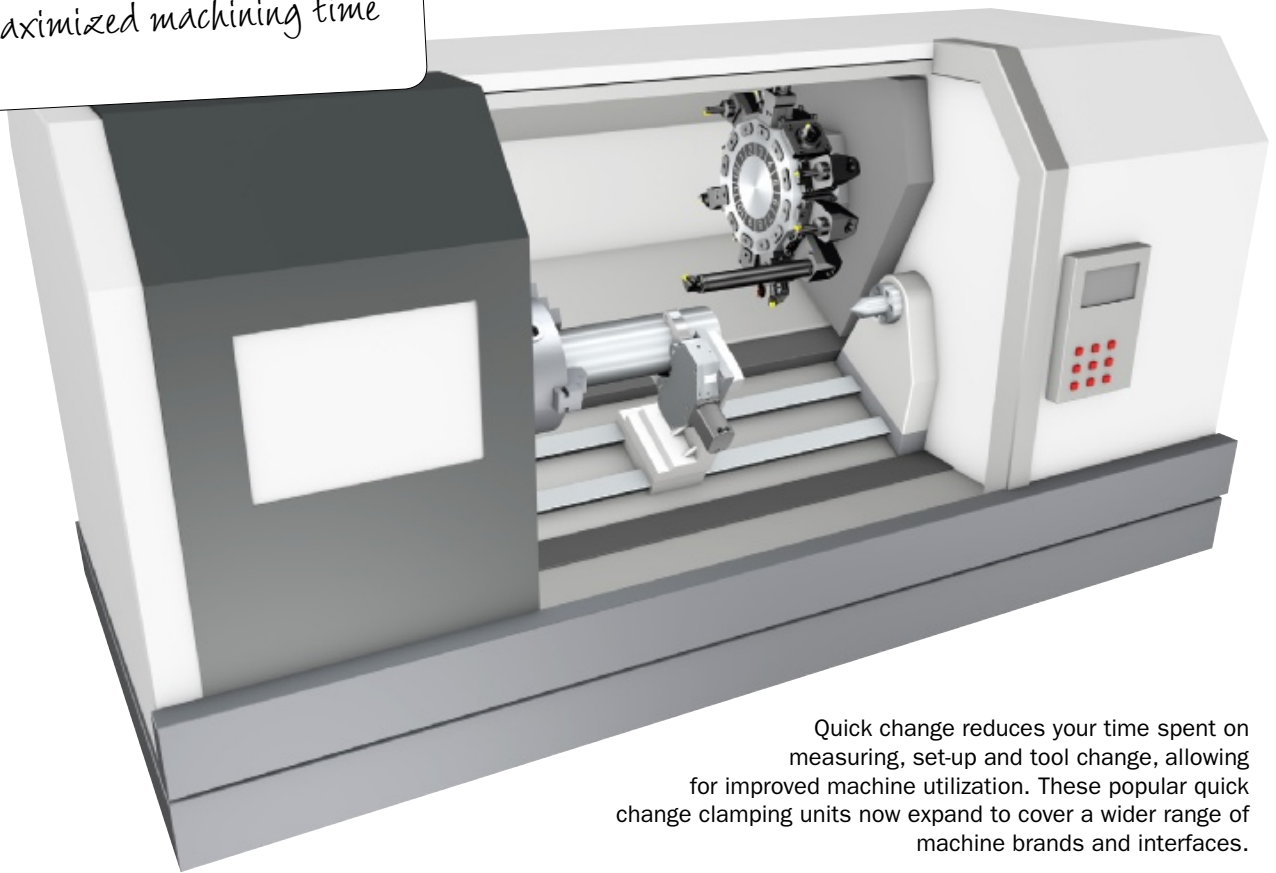

Quick change reduces your time spent on measuring, set-up and tool change, allowing for improved machine utilization. These popular quick change clamping units now expand to cover a wider range of machine brands and interfaces.

Benefits

- Short set-up time
- High machine utilization
- Many components produced per shift
- Short payback time

Application

- Turning centres
- Two-axis and four-axis lathes

Technical features

- Quick change with Coromant Capto® tooling system
- Through coolant delivery on all clamping units
- High rigidity and precision for accurate tool positioning and stability



Quick change clamping units combined with CoroTurn® SL cutting heads and Silent Tools™ is a powerful solution in large turning centre. More on page 20.

Assortment

The assortment expands with 25 new turret interfaces for more than 70 machine models.

Turning centres without milling option

Machine brand	Machine model	Machine interface	Supplement 14.1
Mori Seiki	DuraTurn 2030, 2050, 2550, NLX 2500, (CMZ TC 15 - 35, TL 20, 25)	MS-A	Chapter H
Mori Seiki	SL400, SL404	MS-B	Chapter H
Mori Seiki	SL65, SL600, SL603, SL75	MS-C	Chapter H
Mazak	QTS 200	MZ-A	Chapter H
Mazak	QTN 150, 200, 250, 300, 350, Quick Turn 18 (8 STN), QTS 300, 350	MZ-B	Chapter H
Mazak	QTN 400, 450, Megaturn Nexus 900	MZ-C	Chapter H
Mazak	Slant Turn 50, STN 500, 550 (metric)	MZ-D	Chapter H
Mazak	Slant Turn 50, STN 500, 550 (inch)	MZ-G	Chapter H
Mazak	Slant Turn 60, 80, STN600, (STN800)	MZ-E	Chapter H
Mazak	Slant Turn 60, 80, STN600, (STN800) inch	MZ-H	Chapter H
Okuma	SpaceTurn LB2000	OK-A	Chapter H
Okuma	LB/LU2500, 3000, 4000 EX, LU25, Captain L470, LB15, LB400, Genos L400	OK-B	Chapter H
Okuma	LU35, LB35	OK-E	Chapter H
Okuma	LU45, LB45	OK-F	Chapter H
Doosan	Puma 2100, 2600, 3100	DO-A	Chapter H
Doosan	Puma 400A, 400B, 400LA, 400LB	DO-B	Chapter H
Doosan	Puma 480, 480L, 600, 600L, 700, 700L, 800, 800L	DO-C	Chapter H
Murata	MW120	MA-A	Chapter H
Murata	MW200	MA-B	Chapter H

Turning centres with milling option

Machine brand	Machine model	Machine interface	Supplement 14.1
Mori Seiki	NL, NLX 1500-3000 MC/ Y/ SMC/ CY and NZL 2500	MS60A	Chapter H
Doosan	Puma TT1500, 1800 MS/SY Puma 230-280 M/MS, Puma 1500-2500 M/MS, Puma TLO2000, 2500M, Lynx 300 M	BT55A	Chapter H
Doosan	Puma 400, 480M/LM	BT75A	Chapter H
Doosan	Puma 600/700/800 LM	BT85A	Chapter H
Hwacheon	Cutex-160 MC/SMC	BT55A	Chapter H
Hyundai Wia	L230 LMSA	BT55A	Chapter H
Mazak	QTN200, 250M, MS, MSY	MZ40V	Chapter H
Mazak	Hyper Quadrex 200MSY, MuilotiPlex 6200, 6250Y	MZ40X	Chapter H
Gildemeister	CTX Beta 4A, 4A TC, V6, CTX Gamma V10 (Trifix®)	GM40V	Chapter H
Mazak	Cybertech Turn 4500/5500M, MT, MTN1600	MZ-F	Chapter H

For additional information see www.sandvik.coromant.com

CoroChuck™ 930

High-precision hydraulic chuck

For BIG-PLUS® spindles

CoroChuck 930 is now available with BIG-PLUS interface for machining centres. With the best pull-out security on the market this chuck is designed to eliminate vibration, aiming for excellent stability and accessibility in all milling and drilling operations. Covering all machine interfaces, CoroChuck 930 helps to maintain efficient production through quick and easy tool set-ups and changes. Available as Tailor Made.



Benefits

- Eliminates vibration for secure machining and enhanced surface finish
- Ensures high metal removal rate for increased productivity
- Gives time-efficient tool change and set-up
- Provides long tool life
- Guarantees close hole tolerance

* BIG-PLUS® SYSTEM—licensed by BIG-Daishowa

Application

- Suitable for milling and drilling operations where precision, easy handling and high pull-out security are required
- Covers the majority of machine interfaces, now also in BIG-PLUS spindles

Technical features

- Best pull-out security on the market thanks to Fulcrum technology*
 - Optimized design of the brazed clamping membrane provides excellent clamping performance for pull-out resistance and dampening performance
 - High clamping force repeated time after time
- Easy handling with torque wrench for secure clamping
- The machine-side coupling is ground as last operation for the highest possible precision
- Adjustable clamping lengths by an adjustment screw
- Precision run out <4 µm at 2.5 × cutter diameter

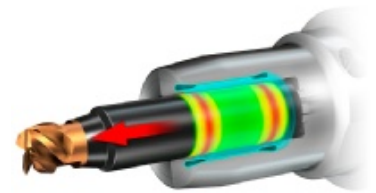

* The secret behind the high precision and pull-out security of CoroChuck 930 is optimized design of the membrane. It allows for secure clamping with two supports on each side (fulcrums).



Optimize CoroChuck 930 for your component. The HD and Slender version with length options in all current machine interfaces.

Assortment

Machine design	Coupling sizes	CoroChuck 930 version	Bore size, mm (inch)	Supplement 14.1
Coromant Capto®	C4–C10	HD, Slender, Pencil	6–32 (0.24–1.26)	Chapter H
HSK	63, 100	HD, Slender, Pencil	6–32 (0.24–1.26)	Chapter H
ISO	40, 50	HD, Slender, Pencil	6–32 (0.24–1.26)	Chapter H
CAT-V	40, 50	HD, Slender, Pencil	6–32 (0.24–1.26)	Chapter H
MAS BT	30, 40, 50	HD, Slender, Pencil	6–32 (0.24–1.26)	Chapter H
ISO BIG-PLUS	40, 50	HD, Slender, Pencil	6–32 (0.24–1.26)	Chapter H
CAT BIG-PLUS	40, 50	HD, Slender, Pencil	6–32 (0.24–1.26)	Chapter H
MAS BT BIG-PLUS	30, 40, 50	HD, Slender, Pencil	6–32 (0.24–1.26)	Chapter H

For additional information visit www.sandvik.coromant.com

Improved stability with BIG-PLUS

BIG-PLUS® spindle system* is adopted by a large number of machining centres and many machine-tool builders have recognized this system for its excellent performance.

BIG-PLUS is a dual-contact system that provides taper and flange contact when tool holders are clamped into the spindle. Improved stability, bending stiffness and higher productivity are some of the benefits offered by this system.

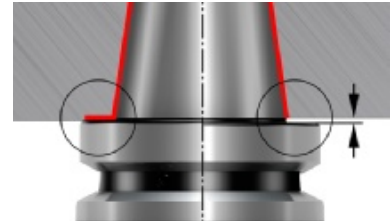

Taper size	Machine interface adaptor	Face mill	Combi Weldon/ISO9766	CoroChuck™ 930	ER collet chuck
30	✓	✓	✓	New	✓
40	✓	✓	✓	New	✓
50	✓	New	New	New	New

* BIG-PLUS® SYSTEM—licensed by BIG-Daishowa



The new BIG-PLUS 50 solid holder assortment consist of Face mill, Combi Weldon/ISO9766 holders and ER collet chucks. Choose solid holders when there is a small need for flexibility in high batch production.

CoroChuck™ 930 provides great stability in BIG-PLUS machining centres, aiming for efficient production.
More information on page 52-53.



Tooling guidelines – solid versus modular

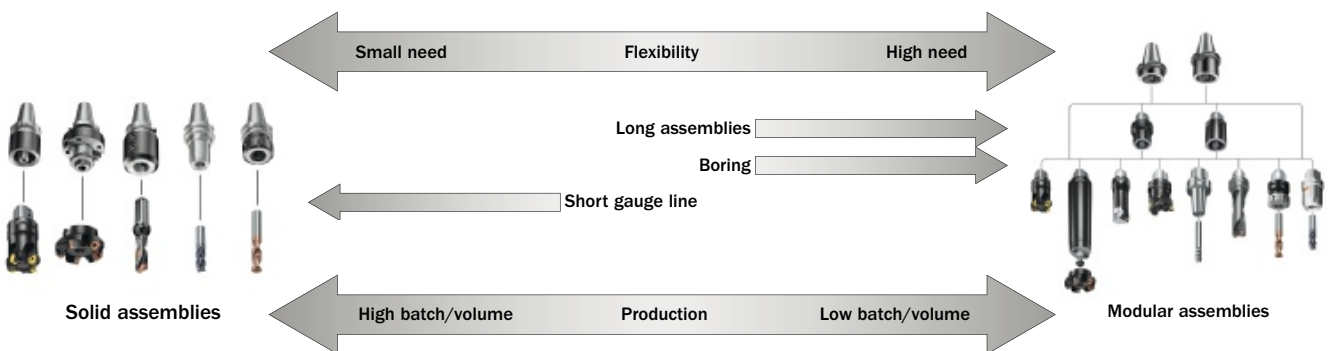

More introductions

General turning

CoroTurn® HP

Slim and flexible coolant connection kit

- Connection kit for shanks or solid boring bars
- Slim design on hose and fittings for flexibility
- To be ordered as complete kit in specified tube lengths or as separate parts

See chapter A, Supplement 14.1



Tool kits

Start-up tool kits for new machines

To help you get started with your new machine, Sandvik Coromant offers start-up tool kits. Included in the tool kits are the typical tools needed to be able to start machining. Choose from 66 different tool kits for the most common turning centres, machining centres and sliding head machines.

See www.sandvik.coromant.com

Find your tool kit!



More introductions

Tooling systems

Coromant EH modular system and CoroMill® 327

New ER adaptors to be used with standard ER nuts

Integrated ER adaptors with improved design allowing use of standard ER- or mini-nuts.

- Short gauge length for chatter-free production with high productivity
- For sliding head machines and turrets in turning centres

See chapter H, Supplement 14.1



Coromant Capto® clamping units

Extension of clamping units for Silent tools™ boring bars

NC3000 round shank with centre bolt clamping

Coromant Capto clamping units	Machine side interface	Tool side interface	Supplement 14.1
Straight	VDI 40	C4, C5	H
Straight	VDI 50	C6, C8	H
Straight	VDI 60	C8	H

See chapter H, Supplement 14.1



Quick change tap adaptors

Now available for ANSI-standard shanks

Without friction clutch, these shanks are suitable for external and internal coolant supply. Quick change tap adaptors offer reduced machine downtime with quick and easy set up and tool changes.

See chapter H, Supplement 14.1

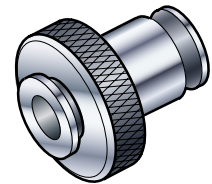

Rotating adaptors

ISO 9766 drill-adaptor extension

Extension of ISO 9766 drill adaptors for Coromant Capto, HSK and BIG-PLUS steep tapers.

- Diameters for CoroDrill® 870: 16 and 5/8" (15.875)
- Diameters for CoroDrill® 880: 40 and 1/2" (38.1)

These drill adaptors can be used in spindles with both automatic and manual tool-change. They feature a light interface that performs well at high spindle speeds.

See chapter H, Supplement 14.1



Tailor Made

Tailored to your needs

Great products are only great if they meet your needs. Each year Sandvik Coromant introduces thousands of new tooling solutions with 24 hours delivery time. But that is not all. Included in our standard offer is also the possibility to tailor some of our tools to fit your specific needs*.

Tools designed for your needs – that is the essence of Tailor Made!
You find Tailor Made forms at www.sandvik.coromant.com.

Engineered solutions

Outside our standard range of tooling solutions, you can order an engineered solution. Contact your Sandvik Coromant representative for more information.

*The delivery time varies depending on which tool you order.

Tailor Made products and their options

CoroMill® Plura

- Cutting diameter
- Number of teeth
- Helix angle
- Type of shank: cylindrical, Weldon or iLock
- Cutting corner: chamfer or corner radius
- Shank diameter
- Neck diameter
- Tool length
- Cutting length
- Usable length



CoroChuck® 930

- Coupling type machine side
- Coupling size machine side
- Coupling type tool side
- Coupling size tool side
- Design version
- Programming length



CoroDrill® 860 -MM

- Drill types: standard single diameter and drill with chamfer
- Shank type: HA and HE
- Intermediate drill length
- Intermediate drill diameter



CoroDrill® 870

Drill tip

- Drill tip diameter
- Point angle
- Corner chamfer
- Corner radius
- Grade
- Geometry

Drill Body

- Drill depth
- Mounting type and size
- Drill body diameter
- 45° chamfer drills



CoroCut® QD

- Insert width
- Insert radius
- Insert shape
- Insert grade

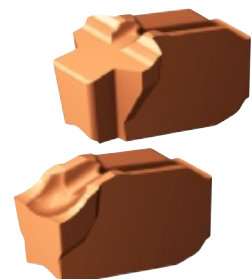

Our main releases from recent CoroPaks

CoroPak 12.1

GENERAL TURNING

CoroTurn® 107, multimaterial inserts
T-Max® P -KRR new geometry
GC3210 new grade

MILLING

CoroMill® Plura and shrink fit adaptors with iLock™
CoroMill® 170 -PL insert
CoroMill® 176 inserts
CoroMill® Century CBN inserts

DRILLING

CoroDrill® 860, for steel
CoroDrill® 870, exchangeable-tip
CoroDrill® 861 for deep holes
CoroDrill® 862, micro drill
CoroTap™
Tap holders
Universal counterboring inserts

TOOLING SYSTEMS

CoroMill® Plura and shrink fit adaptors with iLock™
Tap holders
Quick-change Dovetail, DIN 69881
Dampened milling adaptors, Silent Tools®
Coromant Capto® clamping units
Collet extension

CoroPak 12.2

GENERAL TURNING

T-Max® P and CoroTurn® 107, inserts
Coromant Capto® HP boring bars
QS™ HP holding system
CoroTurn® HP shank tools
Coromant Capto® dampened boring bars, C10
CoroTurn® 107, PCD grade CD05
Heavy turning, inserts and holders

PARTING AND GROOVING

CoroCut® 1- and 2-edges, Seal fin grooving

MILLING

CoroMill® 600 blade cutter
CoroMill® Plura for aluminium
CoroMill® Plura multi-material
CoroMill® S-60 multi-edge cutter

DRILLING

CoroDrill® 860, -NM
CoroDrill® 460, -XM
CoroDrill® 870 for cast iron
CoroDrill® 801 deep hole
CoroDrill® 818 counterboring
New geometry for trepanning
Skiving and roller burnishing
CoroTap™

BORING

CoroReamer™ 435 and 835

TOOLING SYSTEMS

Coromant Capto® VTL
CoroPlex® TB turbo bars
Coromant Capto® Tailor Made adaptors

CoroPak 13.1

GENERAL TURNING

CoroTurn® HP boring bars
T-Max® P, new geometry -PMC boring bars
T-Max® P, new geometry -MRR
CoroTurn® XS, face grooving and internal turning

PARTING AND GROOVING

CoroCut® MB, larger inserts
Angled inserts, new geometry -RO, GC1115

MILLING

CoroMill® 419, high feed
CoroMill® 357, face milling
CoroMill® 316, internal coolant
CoroMill® Plura, for composites
CoroMill® 172, gear milling
CoroMill® 345, new geometry E-KM

DRILLING

CoroDrill® 870, extended range
CoroDrill® 880, Coromant Capto®
CoroDrill® 880, eccentric sleeve
CoroDrill® 801, large diameters
CoroDrill® 818, counterboring
Inserts, TXN
CoroDrill® 800, deep hole drilling

BORING

CoroBore® 825 SL, face grooving

TOOLING SYSTEMS

Coromant Capto® HP clamping units
CoroChuck™ 930, high precision

CoroPak 13.2

GENERAL TURNING

Steel grade GC4325
CoroTurn® HP boring bars
Coromant Capto® bars
CoroTurn® SL with CoroTurn® HP cutting heads

PARTING AND GROOVING

New system; CoroCut® QD

MILLING

CoroMill® 390, EH system
CoroMill® 490, EH system
CoroMill® 316, EH system

DRILLING

CoroDrill® 870, for stainless steel
CoroDrill® R846, ISO S

TAPPING

CoroTap® 200, ISO S

BORING

CoroBore® 824 XS
CoroBore® 825 EH
CoroBore® 820 XL, lightweight
CoroBore® 825 XL, lightweight
CoroBore® 826 XL, lightweight

TOOLING SYSTEMS

EasyFix HP sleeves
CoroTurn® SL Coromant Capto® adaptors
Coromant Capto® EH, heavy metal shank
CoroChuck™ 970

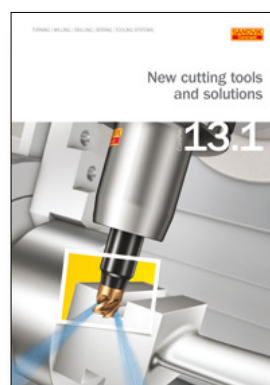
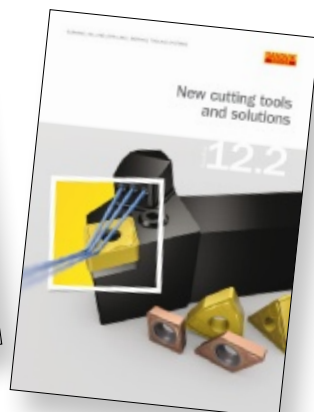

Reference

Metric to imperial

Distance

1 metre (m) = 39.370 inch (in)

1 metre (m) = 3.281 feet (ft)

1 millimetre (mm) = 0.039 inch (in)

Weight

1 kilogram (kg) = 2.205 pounds (lbs)

1 kilogram (kg) = 35.274 ounces (oz)

Torque

1 Newton metre (Nm) =

0.738 pound-force feet (ft-lbs)

1 Newton metre (Nm) =

8.851 pound-force inches (in-lbs)

Imperial to metric

Distance

1 inch (in) = 25.4 millimetre (mm)

1 foot (in) = 0.3 metre (m)

1 foot (in) = 304.8 millimetre (m)

Weight

1 pound (lb) = 0.45 kilogram (kg)

1 ounce (oz) = 28.35 gram (g)

Torque

1 pound-force foot (ft-lbs) =

1.4 Newton metre (Nm)

1 pound-force inch (in-lbs) =

0.1 Newton metre (Nm)

Formulas and definitions

		Metric	Imperial
v_c	cutting speed	m/min	ft/min
n	spindle speed	rpm (rev/min)	rpm (rev/min)
v_f	table feed	mm/min	in/min
Z_n	total number of cutting edges	-	-
Z_c	number of effective cutting edges	-	-
f_z	feed per tooth	mm/z	in/z
f_n	feed per revolution	mm/rev	in/rev
h_{ex}	maximum thickness	mm	inch
a_p	cutting depth	mm	inch
W1	insert width	mm	inch
a_e	cutting width	mm	inch
a_e / D_c	radial immersion	%	%
T	machining time	min	min
D	tool diameter	mm	inch
Q	metal removal rate	cm ³ /min	in ³ /min
nap	number of passes	-	-
TPI	threads per inch	-	-
k_c	specific cutting force	N/mm ²	lbs/in ²
R_a	surface roughness	µm	µin
LF	functional length	mm	inch

Insert size

IC = inscribed circle in inch

 = cutting edge length in mm

ISO application area



Steels



Stainless steels



Cast irons



Non-ferrous metals



Heat resistant materials



Hardened materials



Others, e.g. composite material

Sandvik Coromant

Your success in focus!

With a complete product and service offer Sandvik Coromant is the world leading supplier of cutting tools for the metalworking industry.

We are represented in 130 countries worldwide, with own sales personnel and specialists present in 60 countries. Three central stocking points ensure efficient distribution to customers all over the world, in most markets, within 24 hours.

Along with our hardware comes our software

Our success has been guided by respect for people's ability to create, improve and discover new ways to do things. This belief has opened our eyes to the real needs of our customers. And to the insight that what they are buying from us is not tools but the benefits our tools bring.

Of course we're proud that we're world leaders in the supply of cutting tools. But what's crucial is your endorsement of us as your partner. Our way of meeting your demands is by combining hardware and software; we believe they have equal importance.

Manufacturing economics

To stay competitive you have to bridge the gap between what the market is willing to pay and the cost of production.



Recycling

Tungsten carbide inserts can be recycled in all major markets, at market prices.



Personal service

You can count on us. You will always get full service and support from our Sandvik Coromant representatives.

Your local support is just a click away

www.sandvik.coromant.com

