

Section 24

Terminal Blocks

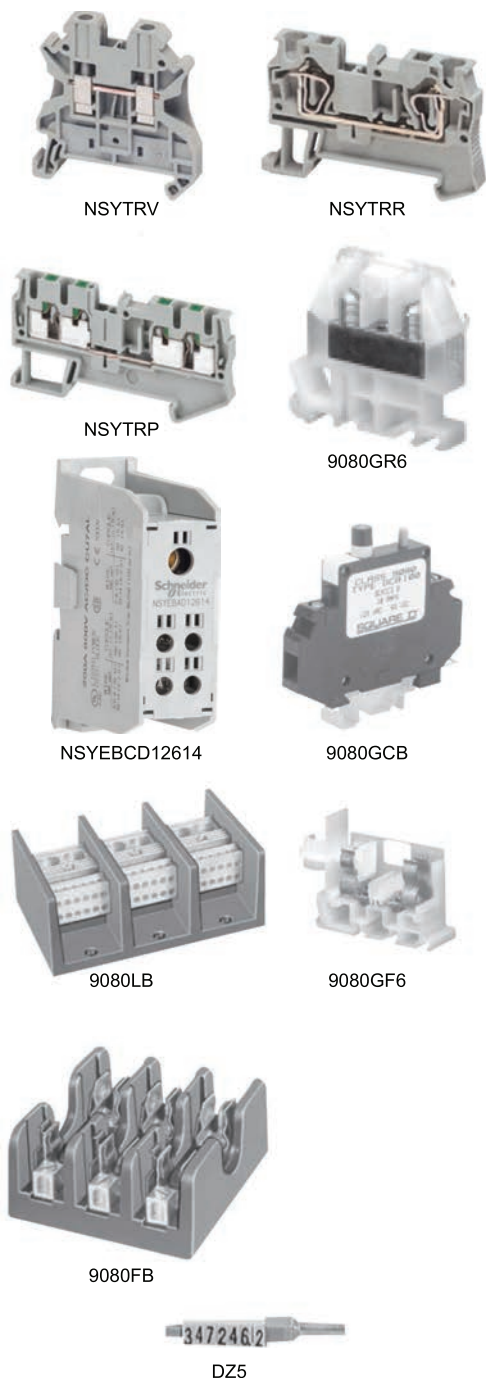





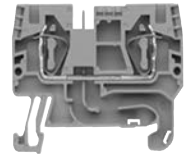

Selection Guide	24-1
Terminal Block Selection Guide	24-1
IEC Style Terminal Blocks	24-3
Spring Terminal Blocks	24-3
Passthrough	24-3
Grounding	24-4
Double and Triple Deck, Grounding, Component Carriers, Blade Isolators	24-5
Miniature Spring Passthrough and Grounding	24-6
Screw Terminal Blocks	24-7
Passthrough and Grounding	24-7
Lug/Lug, Double and Triple Deck Passthrough, Grounding	24-8
Blade Isolators, Component Carriers, Fused, Measuring, Grounding	24-9
Miniature Passthrough and Hybrid Passthrough	24-10
Push-in Terminal Blocks	24-11
Passthrough and Grounding	24-11
Double Deck Passthrough, Blade Isolators, Component Carriers	24-12
Accessories	24-13
Lineary Marking Accessories	24-13
Lineary Labeling System	24-14
Mounting Track and End Clamps	24-15
NEMA Style Terminal Blocks	24-16
Type G Terminal Blocks	24-16
Selection Guide	24-16
Terminal Block Assemblies	24-18
Type G Terminal Block Accessories	24-19
Mounting Track, End Clamps, Jumpers, Fanning Strips	24-19
Marking Accessories	24-20
Thermal-Magnetic Circuit Protectors	24-21
Type GCB Circuit Protectors	24-21
Type GB2 Circuit Protectors	24-22
Power Distribution Blocks	24-23
IEC NSYEB Power Distribution Blocks	24-23
Enclosed Power Distribution Blocks	24-23
NEMA Type LB Power Distribution Blocks	24-24
Open Power Distribution Blocks	24-24
Fuseholders	24-25
Type FB Fuseholders	24-25
TeSys DF Fuseholders	24-26
Cable Ends	24-27
DZ5 and AZ5 Cable Ends	24-27
AR1 and AT1 Cable End Accessories	24-28
Advanteg TELEFAST™ 2	24-29
Prewired Connection System	24-29

24 TERMINAL BLOCKS

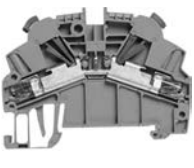
Terminal Block Panorama











Table 24.1: Product Panorama

						
Product Family	NSYTRV	NSYTRR	NSYTRP	NSYTRH	9080G	
Type of product	IEC screw technology	IEC spring technology	IEC push-in technology	IEC hybrid (screw and insulation displacement connection)	NEMA screw technology	
Mounting	DIN 3	DIN 3	DIN 3	DIN 3	DIN 3 and Square D track ^[1]	
Maximum rated voltage (V)	600	600	600	600	600 ^[2]	
Maximum rated current per UL (A)	285	85	30	15	255	
Ambient air temperature	-40 to +266 °F (-40 to 130 °C)					
Approvals ^[3]		UL File E87739 CCN XCFR2	UL File E87739 CCN XCFR2	UL File E87729 CCN XCFR2	UL File E87729 CCN XCFR2	UL File E60616 CCN XCFR2
		CSA File 25644 Class 6228-01	CSA File 25644 Class 6228-01	CSA File 25644 Class 6228-01	CSA File 256444 Class 6228-01	CSA File 025490 Class 3211-07
Color	Gray Blue Orange Red Green White Black Green/Yellow	Gray Blue Orange Green/Yellow	Gray Blue Orange Green/Yellow	Gray Green/Yellow	Natural (White) Black Blue Green Gray Orange Red Yellow Brown	

[1] 9080GK6 can be mounted directly to a panel or on Square D track.
 [2] 9080GT6 is 120 V.
 [3] Refer to catalogs 9080CT1301 and 9080CT9601 for a complete list of certifications.

Passthrough

Table 24.2: Spring Passthrough Blocks

Description	Maximum Voltage	Maximum Current	Block			End Barrier ^[1]		
			Color	Catalog Number	Std. Pack ^[2]	Color	Catalog Number	Std. Pack ^[2]
 5.2 mm (0.21 in.) wide Two Terminals Solid or Stranded Copper Wire 28–12 AWG	600 V	20 A	Grey	NSYTRR22	50	Grey	NSYTRACR22	50
			Blue	NSYTRR22BL		Blue	NSYTRACR22BL	
			Orange	NSYTRR22AR		Grey	NSYTRACR22	
 5.2 mm (0.21 in.) wide Three Terminals Solid or Stranded Copper Wire 28–12 AWG	600 V	20 A	Grey	NSYTRR23	50	Grey	NSYTRACR23	50
			Blue	NSYTRR23BL		Blue	NSYTRACR23BL	
			Orange	NSYTRR23AR		Grey	NSYTRACR23	
 5.2 mm (0.21 in.) wide Four Terminals Solid or Stranded Copper Wire 28–12 AWG	600 V	20 A	Grey	NSYTRR24	50	Grey	NSYTRACR24	50
			Blue	NSYTRR24BL		Blue	NSYTRACR24BL	
			Orange	NSYTRR24AR		Grey	NSYTRACR24	
 6.2 mm (0.24 in.) wide Two Terminals Solid or Stranded Copper Wire 28–10 AWG	600 V	30 A	Grey	NSYTRR42	50	Grey	NSYTRACR42	50
			Blue	NSYTRR42BL		Grey	NSYTRACR42	
			Orange	NSYTRR42AR		Grey	NSYTRACR42	
 6.2 mm (0.24 in.) wide Three Terminals Solid or Stranded Copper Wire 28–10 AWG	600 V	30 A	Grey	NSYTRR43	50	Grey	NSYTRACR43	50
			Blue	NSYTRR43BL		Grey	NSYTRACR43	
 6.2 mm (0.24 in.) wide Four Terminals Solid or Stranded Copper Wire 28–10 AWG	600 V	30 A	Grey	NSYTRR44	50	Grey	NSYTRACR44	50
			Blue	NSYTRR44BL		Grey	NSYTRACR44	
 8.2 mm (0.32 in.) wide Two Terminals Solid or Stranded Copper Wire 28–8 AWG	600 V	50 A	Grey	NSYTRR62	50	Grey	NSYTRACR62	50
			Blue	NSYTRR62BL		Grey	NSYTRACR62	
 8.2 mm (0.32 in.) wide Three Terminals Solid or Stranded Copper Wire 24–8 AWG	600 V	50 A	Grey	NSYTRR63	50	Grey	NSYTRACR63	50
 10.2 mm (0.40 in.) wide Two Terminals Solid or Stranded Copper Wire 16–6 AWG	600 V	66 A	Grey	NSYTRR102	50	Grey	NSYTRACRR102	50
			Blue	NSYTRR102BL		Grey	NSYTRACRR102	
 12.2 mm (0.48 in.) wide Two Terminals Solid or Stranded Copper Wire 16–4 AWG	600 V	85 A	Grey	NSYTRR162	50	Grey	NSYTRACR162	50
			Blue	NSYTRR162BL		Grey	NSYTRACR162	

TERMINAL BLOCKS

24



File:
E87739
CCN:
XCFR2



File:
256444
Class:
6228-01



RoHS
Compliant

For track and accessories, see [Mounting Track and End Clamps, page 24-15](#).

[1] One end-barrier is required for each assembly of like blocks.
 [2] Orders must specify the standard package quantity (Std. Pack) or multiples of that quantity.

Grounding

Table 24.3: Spring Grounding Blocks

Description	Block			End Barrier [3]		
	Color	Catalog Number	Std. Pack [4]	Color	Catalog Number	Std. Pack [4]
 Grounding Block Two Terminals Solid or Stranded Copper Wire 28–12 AWG 5.2 mm (0.21 in.) wide	Green / Yellow	NSYTRR22PE	50	Grey	NSYTRACR22	50
 Grounding Block Three Terminals Solid or Stranded Copper Wire 28–12 AWG 5.2 mm (0.21 in.) wide	Green / Yellow	NSYTRR23PE	50	Grey	NSYTRACR23	50
 Grounding Block Four Terminals Solid or Stranded Copper Wire 28–12 AWG 5.2 mm (0.21 in.) wide	Green / Yellow	NSYTRR24PE	50	Grey	NSYTRACR24	50
 Grounding Block Two Terminals Solid or Stranded Copper Wire 28–10 AWG 6.2 mm (0.24 in.) wide	Green / Yellow	NSYTRR42PE	50	Grey	NSYTRACR42	50
 Grounding Block Three Terminals Solid or Stranded Copper Wire 28–10 AWG 6.2 mm (0.24 in.) wide	Green / Yellow	NSYTRR43PE	50	Grey	NSYTRACR43	50
 Grounding Block Four Terminals Solid or Stranded Copper Wire 28–10 AWG 6.2 mm (0.24 in.) wide	Green / Yellow	NSYTRR44PE	50	Grey	NSYTRACR44	50
 Grounding Block Two Terminals Solid or Stranded Copper Wire 24–8 AWG 8.2 mm (0.32 in.) wide	Green / Yellow	NSYTRR62PE	50	Grey	NSYTRACR62	50
 Grounding Block Two Terminals Solid or Stranded Copper Wire 16–6 AWG 10.2 mm (0.40 in.) wide	Green / Yellow	NSYTRR102PE	50	Grey	NSYTRACR102	50
 Grounding Block Two Terminals Solid or Stranded Copper Wire 16–4 AWG 12.2 mm (0.48 in.) wide	Green / Yellow	NSYTRR162PE	50	Grey	NSYTRACR162	10

 File:
E87739
CCN:
XCFR2

 File:
256444
Class:
6228-01

 RoHS
Compliant

 For track and accessories, see [Mounting Track and End Clamps](#), page 24-15.

[3] One end-barrier is required for each assembly of like blocks.

[4] Orders must specify the standard package quantity (Std. Pack) or multiples of that quantity.

Double and Triple Deck, Grounding, Component Carriers, Blade Isolators

Table 24.4: Spring Double and Triple Deck Passthrough



Description	Max. Voltage	Max. Current [5]	Block			End Barrier [6]		
			Color	Catalog Number	Std. Pack [7]	Color	Catalog Number	Std. Pack [7]
 5.2 mm (0.21 in.) wide	600 V	20 A	Grey	NSYTRR24D	50	Grey	NSYTRACRE24	50
			Blue	NSYTRR24DBL		Grey	NSYTRACRE24	
 6.2 mm (0.24 in.) wide	600 V	30 A	Grey	NSYTRR44D	50	Grey	NSYTRACRE44	50
			Blue	NSYTRR44DBL		Grey	NSYTRACRE44	
 5.2 mm (0.21 in.) wide	600 V	20 A	Grey	NSYTRR26T	50	Grey	NSYTRACRE26	50
			Blue	NSYTRR26TBL		Grey	NSYTRACRE26	

Table 24.5: Spring Grounding Double Deck



Description	Block			End Barrier [6]		
	Color	Catalog Number	Std. Pack [7]	Color	Catalog Number	Std. Pack [7]
 5.2 mm (0.21 in.) wide	Green/Yellow	NSYTRR24DPE	50	Grey	NSYTRACRE24	50
 6.2 mm (0.24 in.) wide	Green/Yellow	NSYTRR44DPE	50	Grey	NSYTRACRE44	50

Table 24.6: Spring Component Carriers





Description	Max. Voltage	Max. Current [5]	Color	Catalog Number	Std. Pack [7]	End Barrier [6]				
						Color	Catalog Number	Std. Pack [7]		
 5.2 mm (0.21 in.) wide	300 V	16 A	Grey	NSYTRR22TB	50	Grey	NSYTRACR23	50		
				Depends on fuse or diode used	Black				NSYTRASF520	10
					Black				NSYTRASF520M	10
					Black				NSYTRASF520B	10
				Grey	NSYTRASV1				10	
				Grey	NSYTRASV2				10	
 5.2 mm (0.21 in.) wide	300 V	16 A	Grey	NSYTRR23TB	50	Grey	NSYTRACR24	50		
				Depends on fuse or diode used	Black				NSYTRASF520	10
					Black				NSYTRASF520M	10
					Black				NSYTRASF520B	10
				Grey	NSYTRASV1				10	
				Grey	NSYTRASV2				10	

Table 24.7: Spring Blade Isolators

Description	Max. Voltage	Max. Current [5]	Block			End Barrier [6]		
			Color	Catalog Number	Std. Pack [7]	Color	Catalog Number	Std. Pack [7]
 5.2 mm (0.21 in.) wide	600 V	16 A	Grey	NSYTRR22SC	50	Grey	NSYTRACR23	50
			Orange	NSYTRR22SCAR		Grey	NSYTACR23	
 5.2 mm (0.21 in.) wide	600 V	16 A	Grey	NSYTRR23SC	50	Grey	NSYTACR24	50
			Orange	NSYTRR23SCAR		Grey	NSYTACR24	
 5.2 mm (0.21 in.) wide	300 V	10 A	Grey	NSYTRR24SCD	50	Not required for this block.		



File: E87739
CCN: XCFR2



File: 256444
Class: 6228-01



RoHS Compliant

For track and accessories, see [Mounting Track and End Clamps, page 24-15](#).

[5] These maximum current values assume the use of insulated copper conductors with 167 °F (75 °C) temperature rating and are calculated based on NEC Article 310, Table 310-16. In most cases this value is the maximum ampacity of the wire which has the greatest current carrying capacity. The actual allowable current for a particular application depends on the size, insulation class, and other characteristics of the wire used. The UL ratings are shown. The CSA rating may be higher or lower. Refer to the catalog for CSA ratings.

[6] One end-barrier is required for each assembly of like blocks.

[7] Orders must specify the standard package quantity (Std. Pack) or multiples of that quantity.

Miniature Spring Passthrough and Grounding

Table 24.8: Miniature Spring Passthrough DIN Rail Mounting



Description	Maximum Voltage	Maximum Current [8]	Block			End Barrier [9]		
			Color	Catalog Number	Std. Pack [10]	Color	Catalog Number	Std. Pack [10]
 5.2 mm (0.21 in.) wide Two Terminals Solid or Stranded Copper Wire 28–12 AWG Mount on DIN Rail 15 x 7.2 mm	600 V	20 A	Grey	NSYTRR22M	50	Grey	NSYTRACRM22	50
			Blue	NSYTRR22MBL		Grey	NSYTRACRM22	
 10.4 mm (0.41 in.) wide Four Terminals Solid or Stranded Copper Wire 28–12 AWG Mount on DIN Rail 15 x 7.2 mm	600 V	20 A	Grey	NSYTRR24M	50	Grey	NSYTRACRM22	50
			Blue	NSYTRR24MBL		Grey	NSYTRACRM22	

Table 24.9: Miniature Spring Grounding Type





Description	Block			End Barrier [9]		
	Color	Catalog Number	Std. Pack [10]	Color	Catalog Number	Std. Pack [10]
 5.2 mm (0.21 in.) wide Grounding Block, Two Terminals, Solid or Stranded Copper Wire 28–12 AWG Mount on DIN Rail 15 x 7.2 mm	Green/Yellow	NSYTRR22MPE	50	Grey	NSYTRACRM22	50

Table 24.10: Miniature Spring Passthrough Direct Mounting and for Micro-Perforated Mounting Plates

Description	Maximum Voltage	Maximum Current [8]	Block			End Barrier [9]		
			Color	Catalog Number	Std. Pack [10]	Color	Catalog Number	Std. Pack [10]
 5.2 mm (0.21 in.) wide Direct Mounting (Flange) Two Terminals Solid or Stranded Copper Wire 28–12 AWG	600 V	20 A	Grey	NSYTRR22MF	50	Grey	NSYTRACRM22	50
			Blue	NSYTRR22MFBL		Grey	NSYTRACRM22	
			Grey	NSYTRR22MFF [11]		Grey	NSYTRACRM22 or NSYTRACRMF22 [11]	
 10.4 mm (0.41 in.) wide Direct Mounting (Flange) Four Terminals Solid or Stranded Copper Wire 28–12 AWG	600 V	20 A	Grey	NSYTRR24MF	50	Grey	NSYTRACRM22	50
			Blue	NSYTRR24MFBL		Grey	NSYTRACRM22	
			Grey	NSYTRR24MFF [11]		Grey	NSYTRACRM22 or NSYTRACRMF22 [11]	
 5.2 mm (0.21 in.) wide For Micro-Perforated Mounting Plates Two Terminals Solid or Stranded Copper Wire 28–12 AWG	600 V	20 A	Grey	NSYTRR22MP	50	Grey	NSYTRACRM22	50
			Blue	NSYTRR22MPBL		Grey	NSYTRACRM22	
 10.4 mm (0.41 in.) wide For Micro-Perforated Mounting Plates Four Terminals Solid or Stranded Copper Wire 28–12 AWG	600 V	20 A	Grey	NSYTRR24MP	50	Grey	NSYTRACRM22	50
			Blue	NSYTRR24MBL		Grey	NSYTRACRM22	



File: E87739, CCN: XCFR2



File: 256444, Class: 6228-01

RoHS
CompliantFor track and accessories, see [Mounting Track and End Clamps](#), page 24-15.

[8] These maximum current values assume the use of insulated copper conductors with 167 °F (75 °C) temperature rating and are calculated based on NEC Article 310, Table 310-16. In most cases this value is the maximum ampacity of the wire which has the greatest current carrying capacity. The actual allowable current for a particular application depends on the size, insulation class, and other characteristics of the wire used. The UL ratings are shown. The CSA rating may be higher or lower. Refer to the catalog for CSA ratings.

[9] One end-barrier is required for each assembly of like blocks.

[10] Orders must specify the standard package quantity (Std. Pack) or multiples of that quantity.

[11] With flange. Can only be used at the end of a group of terminals.

Passthrough and Grounding

Table 24.11: Screw Type Passthrough Blocks

Description	Maximum Voltage	Maximum Current [12]	Block			End Barrier [13]		
			Color	Catalog Number	Std. Pack [14]	Color	Catalog Number	Std. Pack [14]
 5.2 mm (0.21 in.) wide Two Terminals Solid or Stranded Copper Wire 26–12 AWG	600 V	20 A	Grey	NSYTRV22	50	Grey	NSYTRAC22	50
			Blue	NSYTRV22BL		Blue	NSYTRAC22BL	
			Orange	NSYTRV22AR		Grey	NSYTRAC22	
			Red	NSYTRV22RD		Grey	NSYTRAC22	
			White	NSYTRV22WH		Grey	NSYTRAC22	
 6.2 mm (0.24 in.) wide Two Terminals Solid or Stranded Copper Wire 26–10 AWG	600 V	00 A	Grey	NSYTRV42	50	Grey	NSYTRAC22	50
			Blue	NSYTRV42BL		Blue	NSYTRAC22BL	
			Orange	NSYTRV42AR		Grey	NSYTRAC22	
			Red	NSYTRV42RD		Grey	NSYTRAC22	
			Green	NSYTRV42GN		Grey	NSYTRAC22	
			White	NSYTRV42WH		Grey	NSYTRAC22	
 8.2 mm (0.32 in.) wide Two Terminals Solid or Stranded Copper Wire 24–8 AWG	600 V	50 A	Grey	NSYTRV62	50	Grey	NSYTRAC22	50
			Blue	NSYTRV62BL		Blue	NSYTRAC22BL	
 10.2 mm (0.40 in.) wide Two Terminals Solid or Stranded Copper Wire 20–6 AWG	600 V	65 A	Grey	NSYTRV102	50	Grey	NSYTRAC22	50
			Blue	NSYTRV102BL		Blue	NSYTRAC22BL	
 12.2 mm (0.48 in.) wide Two Terminals Solid or Stranded Copper Wire 16–4 AWG	600 V	85 A	Grey	NSYTRV162	50	Grey	NSYTRAC162	50
			Blue	NSYTRV162BL		Grey	NSYTRAC162	
 16 mm (0.63 in.) wide Two Terminals Solid or Stranded Copper Wire 14–1/0 AWG	600 V	150 A	Grey	NSYTRV352	50	Not required for these blocks.		
			Blue	NSYTRV352BL				
 20 mm (0.79 in.) wide Two Terminals Solid or Stranded Copper Wire 6–1/0 AWG	600 V	150 A	Grey	NSYTRV502	50	Not required for these blocks.		
			Blue	NSYTRV502BL				

Table 24.12: Screw Type Grounding Blocks

Description	Block			End Barrier [13]		
	Color	Catalog Number	Std. Pack [14]	Color	Catalog Number	Std. Pack [14]
 5.2 mm (0.21 in.) wide Grounding Block Two Terminals Solid or Stranded Copper Wire 26–12 AWG	Green/Yellow	NSYTRV22PE	50	Grey	NSYTRAC22	50
 6.2 mm (0.24 in.) wide Grounding Block Two Terminals Solid or Stranded Copper Wire 26–10 AWG	Green/Yellow	NSYTRV42PE	50	Grey	NSYTRAC22	50
 8.2 mm (0.32 in.) wide Grounding Block Two Terminals Solid or Stranded Copper Wire 24–8 AWG	Green/Yellow	NSYTRV62PE	50	Grey	NSYTRAC22	50
 10.2 mm (0.40 in.) wide Grounding Block Two Terminals Solid or Stranded Copper Wire 20–6 AWG	Green/Yellow	NSYTRV102PE	50	Grey	NSYTRAC22	50
 12.2 mm (0.48 in.) wide Grounding Block Two Terminals Solid or Stranded Copper Wire 16–4 AWG	Green/Yellow	NSYTRV162PE	50	Grey	NSYTRAC162	50
 16 mm (0.63 in.) wide Grounding Block Two Terminals Solid or Stranded Copper Wire 14–1/0 AWG	Green/Yellow	NSYTRV352PE	50	Not required for this block.		
 20 mm (0.79 in.) wide Grounding Block Two Terminals Solid or Stranded Copper Wire 6–1/0 AWG	Green/Yellow	NSYTRV502PE	50	Not required for this block.		



File: E87739; CCN: XCFR2



File: 256444; Class: 6228-01



RoHS Compliant

For track and accessories, see page 24-15.

[12] These maximum current values assume the use of insulated copper conductors with 167 °F (75 °C) temperature rating and are calculated based on NEC Article 310, Table 310-16. In most cases this value is the maximum ampacity of the wire which has the greatest current carrying capacity. The actual allowable current for a particular application depends on the size, insulation class, and other characteristics of the wire used. The UL ratings are shown. The CSA rating may be higher or lower. Refer to the catalog for CSA ratings.

[13] One end-barrier is required for each assembly of like blocks.

[14] Orders must specify the standard package quantity (Std. Pack) or multiples of that quantity.

Lug/Lug, Double and Triple Deck Passthrough, Grounding

Table 24.13: Passthrough, Lug/Lug, and Lug/Clamp





Description	Block				Partition Cover			
	Maximum Current ^[15]	Color	Catalog Number	Std. Pack ^[16]	Color	Catalog Number	Std. Pack ^[16]	
 20.3 mm (0.80 in.) wide Passthrough Solid or Stranded Copper Wire 4–3/0 AWG Screw thread M8 Maximum Voltage–600 V	192 A	Grey	NSYTRV702	10	Not required for this block.			
 40 mm (1.58 in.) wide Lug to Lug Solid or Stranded Copper Wire 2–4/0 AWG Screw thread M12 Maximum Voltage–600 V	230 A	Grey	NSYTRV952BB	10	Grey	NSYTRAC952	10	
 40 mm (1.58 in.) wide Solid or Stranded Copper Wire 2–4/0 AWG Screw thread M12 Maximum Voltage–600 V	230 A	Grey	NSYTRV952BC	10	Grey	NSYTRAC952	10	
 46 mm (1.81 in.) wide Lug to Lug Solid or Stranded Copper Wire 2–300 AWG/kcmil Screw thread M12 Maximum Voltage–600 V	285 A	Grey	NSYTRV1502BB	10	Grey	NSYTRAC952	10	

Table 24.14: Screw Type Double and Triple Deck Passthrough









Description	Maximum Voltage	Maximum Current ^[15]	Block			End Barrier ^[17]		
			Color	Catalog Number	Std. Pack ^[16]	Color	Catalog Number	Std. Pack ^[16]
 6.2 mm (0.24 in.) wide Double Deck, One Pole, Three Terminals Solid or Stranded Copper Wire 26–10 AWG	150 V	30 A	Grey	NSYTRV43	50	Grey	NSYTRAC23	50
			Blue	NSYTRV43BL		Grey	NSYTRAC23	
 6.2 mm (0.24 in.) wide Double Deck, One Pole, Four Terminals Solid or Stranded Copper Wire 26–10 AWG	150 V	30 A	Grey	NSYTRV44	50	Grey	NSYTRAC24	50
			Blue	NSYTRV44BL		Grey	NSYTRAC24	
 5.2 mm (0.21 in.) wide Double Deck, Two Poles, Four Terminals Solid or Stranded Copper Wire 26–12 AWG	600 V	20 A	Grey	NSYTRV24D	50	Grey	NSYTRACE24	50
			Blue	NSYTRV24DBL		Grey	NSYTRACE24	
 6.2 mm (0.24 in.) wide Double Deck, Two Poles, Four Terminals Solid or Stranded Copper Wire 26–10 AWG	600 V	30 A	Grey	NSYTRV44D	50	Grey	NSYTRACE24	50
			Blue	NSYTRV44DBL		Grey	NSYTRACE24	
 5.2 mm (0.21 in.) wide Triple Deck, Three Poles, Six Terminals Solid or Stranded Copper Wire 26–10 AWG	600 V	20 A	Grey	NSYTRV26T	50	Grey	NSYTRACE26	50

Table 24.15: Screw Type Grounding Double Deck

Description	Block			End Barrier ^[17]		
	Color	Catalog Number	Std. Pack ^[16]	Color	Catalog Number	Std. Pack ^[16]
 6.2 mm (0.24 in.) wide Grounding Block, One Pole, Three Terminals Solid or Stranded Copper Wire 26–12 AWG	Green/Yellow	NSYTRV43PE	50	Grey	NSYTRAC23	50
 6.2 mm (0.24 in.) wide Grounding Block, One Pole, Four Terminals Solid or Stranded Copper Wire 26–12 AWG	Green/Yellow	NSYTRV44PE	50	Grey	NSYTRAC24	50
 5.2 mm (0.21 in.) wide Grounding Block, One Pole, Four Terminals Solid or Stranded Copper Wire 26–12 AWG	Green/Yellow	NSYTRV24DPE	50	Grey	NSYTRACE24	50
 6.2 mm (0.24 in.) wide Grounding Block, One Pole, Four Terminals Solid or Stranded Copper Wire 26–10 AWG	Green/Yellow	NSYTRV44DPE	50	Grey	NSYTRACE24	50

File: E87739
CCN: XCFR2File: 256444
Class: 6228-01

RoHS Compliant

For track and accessories, see page 24-15.

[15] These maximum current values assume the use of insulated copper conductors with 167 °F (75 °C) temperature rating and are calculated based on NEC Article 310, Table 310-16. In most cases this value is the maximum ampacity of the wire which has the greatest current carrying capacity. The actual allowable current for a particular application depends on the size, insulation class, and other characteristics of the wire used. The UL ratings are shown. The CSA rating may be higher or lower. Refer to the catalog for CSA ratings.

[16] Orders must specify the standard package quantity (Std. Pack) or multiples of that quantity.

[17] One end-barrier is required for each assembly of like blocks.

Blade Isolators, Component Carriers, Fused, Measuring, Grounding

Table 24.16: Screw Type Blade Isolators



Description	Maximum Voltage	Maximum Current [18]	Block			End Barrier [19]		
			Color	Catalog Number	Std. Pack [20]	Color	Catalog Number	Std. Pack [20]
 Blade Isolator Two Terminals Solid or Stranded Copper Wire 26–10 AWG 6.2 mm (0.24 in.) wide	600 V	16 A	Grey	NSYTRV42SC	50	Not required for this block.		
			Grey with Test Points	NSYTRV42ST				
			Orange with Test Points	NSYTRV42STAR				
 Blade Isolator Double Deck Four Terminals Solid or Stranded Copper Wire 26–10 AWG 6.2 mm (0.24 in.) wide	300 V	30 A	Grey	NSYTRV42SCD	50	Grey	NSYTRACE24	50

Table 24.17: Screw Type Component Carrier







Description	Maximum Voltage	Maximum Current [18]	Color	Catalog Number	Std. Pack [20]	End Barrier [19]	
 Component Carrier Two Terminals Solid or Stranded Copper Wire 26–10 AWG 6.2 mm (0.24 in.) wide	600 V	16 A	Grey	NSYTRV42TB	50	Not required for this block	
			Black	For fuse 5 x 20 mm	NSYTRASF520	10	Not required
				For fuse 5 x 20 mm 110–250 V LED	NSYTRASF520M	10	
				For fuse 5 x 20 mm 12–30 V LED	NSYTRASF520B	10	
			For component	Grey	NSYTRASV1	10	
			With 1N4007 diode	Grey	NSYTRASV2	10	

Table 24.18: Fused Terminal Blocks

Description	Color	Catalog Number	Std. Pack [20]	End Barrier [19]			
				Color	Catalog Number	Std. Pack [20]	
 Fuse Block For G-fuse cartridge 5x20 mm Solid or Stranded Copper Wire 24–6 AWG Maximum Voltage 300 V Maximum Current 20 A [18]	Black	NSYTRV162SF	50	Not required for this block.			
 Lever-Type Fuse For G-fuse cartridge 5x20 mm Solid or Stranded Copper Wire 26–10 AWG Maximum Voltage 600 V Maximum Current 12 A [18]	Without Indicator Lamp	Black	NSYTRV42SF5	50	Not required for this block.		
	With Light Indicator, 12–30 V AC/DC [21]	Black	NSYTRV42SF5LD	50			
	With Light Indicator, 110–250 V AC/DC [21]	Black	NSYTRV42SF5LA	50			
 Lever-Type Fuse For G-fuse cartridge 6.3x32 mm Solid or Stranded Copper Wire 26–8 AWG Maximum Voltage 600 V Maximum Current 10 A [18]	Without Indicator Lamp	Black	NSYTRV42SF6	50	Not required for this block.		
	With Light Indicator, 12–30 V AC/DC [21]	Black	NSYTRV42SF6LD	50			
	With Light Indicator, 110–250 V AC/DC [21]	Black	NSYTRV42SF6LA	50			

These measuring transducer terminal blocks with screw connection technology are characterized by easy operation and clarity. All switching statuses are clearly visible. The extensive range of flexible accessories saves cost and time when executing transducer test circuit tasks.

Table 24.19: Measuring and Grounding Terminal Blocks

Description	Maximum Voltage	Maximum Current [18]	Block			End Barrier [19]		
			Color	Catalog Number	Std. Pack [20]	Color	Catalog Number	Std. Pack [20]
 Blade Isolator Double Deck Solid or Stranded Copper Wire 24–8 AWG 8.2 mm (0.32 in.) wide	600 V	30 A	Grey	NSYTRV62TTD	50	Grey	NSYTRACT22	50
 Passthrough Two Terminals Solid or Stranded Copper Wire 24–8 AWG 8.2 mm (0.32 in.) wide	600 V	30 A	Grey	NSYTRV62TT	50			
 Grounding Block Two Terminals Solid or Stranded Copper Wire 24–8 AWG 8.2 mm (0.32 in.) wide	N/A	N/A	Green/Yellow	NSYTRV62TTPE	50			



File: E87739
CCN: XCFR2



File: 256444
Class: 6228-01



RoHS Compliant

For track and accessories, see [Mounting Track and End Clamps](#), page 24-15.

[18] These maximum current values assume the use of insulated copper conductors with 167 °F (75 °C) temperature rating and are calculated based on NEC Article 310, Table 310-16. In most cases this value is the maximum ampacity of the wire which has the greatest current carrying capacity. The actual allowable current for a particular application depends on the size, insulation class, and other characteristics of the wire used. The UL ratings are shown. The CSA rating may be higher or lower. Refer to the catalog for CSA ratings.

[19] One end-barrier is required for each assembly of like blocks.

[20] Orders must specify the standard package quantity (Std. Pack) or multiples of that quantity.

[21] When voltage is applied within the minimum and maximum limits, the LED will illuminate.

Miniature Passthrough and Hybrid Passthrough

Table 24.20: Screw Type Miniature Passthrough



Description	Maximum Voltage	Maximum Current [22]	Block			End Barrier [23]		
			Color	Catalog Number	Std. Pack [24]	Color	Catalog Number	Std. Pack [24]
 5.2 mm (0.21 in.) wide Two Terminals Solid or Stranded Copper Wire 24–12 AWG Mount on DIN rail, 5 x 5 mm	600 V	20 A	Grey	NSYTRV22M	50	Grey	NSYTRACM22	50
			Blue	NSYTRV22MBL		Grey	NSYTRACM22	
 6.2 mm (0.24 in.) wide Two Terminals Solid or Stranded Copper Wire 24–10 AWG Mount on DIN rail, 5 x 5 mm	600 V	30 A	Grey	NSYTRV42M	50	Grey	NSYTRACM22	50
			Blue	NSYTRV42MBL		Grey	NSYTRACM22	

Table 24.21: Screw Type Miniature Grounding Blocks



Description	Block			End Barrier [23]		
	Color	Catalog Number	Std. Pack [24]	Color	Catalog Number	Std. Pack [24]
 5.2 mm (0.21 in.) wide Grounding Block Two Terminals Solid or Stranded Copper Wire 24–12 AWG Mount on DIN rail, 5 x 5 mm	Green/Yellow	NSYTRV22MPE	50	Grey	NSYTRACM22	50
 6.2 mm (0.24 in.) wide Grounding Block Two Terminals Solid or Stranded Copper Wire 24–10 AWG Mount on DIN rail, 5 x 5 mm	Green/Yellow	NSYTRV42MPE	50	Grey	NSYTRACM22	50

Table 24.22: Hybrid Blocks—Screw and Insulation Displacement Connection (IDC) Passthrough





Description	Maximum Voltage	Maximum Current [22]	Block			End Barrier [23]		
			Color	Catalog Number	Std. Pack [24]	Color	Catalog Number	Std. Pack [24]
 5.2 mm (0.21 in.) wide Two Terminals Solid or Stranded Copper Wire 24–16 AWG	600 V	10 A	Grey	NSYTRH12	50	Grey	NSYTRACH12	50
 5.2 mm (0.21 in.) wide Three Terminals Solid or Stranded Copper Wire 24–16 AWG	600 V	10 A	Grey	NSYTRH13	50	Grey	NSYTRACH13	50
 6.2 mm (0.24 in.) wide Three Terminals Solid or Stranded Copper Wire 20–14 AWG	600 V	15 A	Grey	NSYTRH22	50	Grey	NSYTRACH22	50

Table 24.23: Hybrid Grounding Block—Screw and Insulation Displacement Connection (IDC) Passthrough

Description	Block			End Barrier [23]		
	Color	Catalog Number	Std. Pack [24]	Color	Catalog Number	Std. Pack [24]
 5.2 mm (0.21 in.) wide Grounding Block Two Terminals Solid or Stranded Copper Wire 24–16 AWG	Green/Yellow	NSYTRH12PE	50	Grey	NSYTRACH12	50



File:
E87739
CCN:
XCFR2



File:
256444
Class:
6228-01



RoHS
Compliant

For track and accessories, see [Mounting Track and End Clamps](#), page 24-15.

[22] These maximum current values assume the use of insulated copper conductors with 167 °F (75 °C) temperature rating and are calculated based on NEC Article 310, Table 310-16. In most cases this value is the maximum ampacity of the wire which has the greatest current carrying capacity. The actual allowable current for a particular application depends on the size, insulation class, and other characteristics of the wire used. The UL ratings are shown. The CSA rating may be higher or lower. Refer to the catalog for CSA ratings.

[23] One end-barrier is required for each assembly of like blocks.

[24] Orders must specify the standard package quantity (Std. Pack) or multiples of that quantity.

Passthrough and Grounding

Push-in technology terminal blocks feature simple handling and direct, tool-free connections. When pushing in solid wires or wires with ferrules, the contact spring is automatically opened and ensures the required pressure force against the current bar.

Table 24.24: Push-in Passthrough Blocks











Description	Maximum Voltage	Maximum Current [25]	Block			End Barrier [26]		
			Color	Catalog Number	Std. Pack [27]	Color	Catalog Number	Std. Pack [27]
 Two Terminals Solid or Stranded Copper Wire 24–12 AWG 5.2 mm (0.21 in.) wide	600 V	20 A	Grey	NSYTRP22	50	Grey	NSYTRACR22	50
			Blue	NSYTRP22BL		Blue	NSYTRACR22BL	
			Orange	NSYTRP22AR		Grey	NSYTRACR22	
 Three Terminals Solid or Stranded Copper Wire 24–12 AWG 5.2 mm (0.21 in.) wide	600 V	20 A	Grey	NSYTRP23	50	Grey	NSYTRACR23	50
			Blue	NSYTRP23BL		Blue	NSYTRACR23BL	
			Orange	NSYTRP23AR		Grey	NSYTRACR23	
 Four Terminals Solid or Stranded Copper Wire 24–12 AWG 5.2 mm (0.21 in.) wide	600 V	20 A	Grey	NSYTRP24	50	Grey	NSYTRACR24	50
			Blue	NSYTRP24BL		Blue	NSYTRACR24BL	
 Two Terminals Solid or Stranded Copper Wire 24–10 AWG 6.2 mm (0.24 in.) wide	600 V	30 A	Grey	NSYTRP42	50	Grey	NSYTRACR42	50
			Blue	NSYTRP42BL		Grey	NSYTRACR42	
 Three Terminals Solid or Stranded Copper Wire 24–10 AWG 6.2 mm (0.24 in.) wide	600 V	30 A	Grey	NSYTRP43	50	Grey	NSYTRACP43	50
			Blue	NSYTRP43BL		Grey	NSYTRACP43	
 Four Terminals Solid or Stranded Copper Wire 24–10 AWG 6.2 mm (0.24 in.) wide	600 V	30 A	Grey	NSYTRP44	50	Grey	NSYTRACP44	50
			Blue	NSYTRP44BL		Grey	NSYTRACP44	

Table 24.25: Push-in Grounding Blocks

Description	Block			End Barrier [26]		
	Color	Catalog Number	Std. Pack [27]	Color	Catalog Number	Std. Pack [27]
 Grounding Block Two Terminals Solid or Stranded Copper Wire 24–12 AWG 5.2 mm (0.21 in.) wide	Green/Yellow	NSYTRP22PE	50	Grey	NSYTRACR22	50
 Grounding Block Three Terminals Solid or Stranded Copper Wire 24–12 AWG 5.2 mm (0.21 in.) wide	Green/Yellow	NSYTRP23PE	50	Grey	NSYTRACR23	50
 Grounding Block Four Terminals Solid or Stranded Copper Wire 24–12 AWG 5.2 mm (0.21 in.) wide	Green/Yellow	NSYTRP24PE	50	Grey	NSYTRACR24	50
 Grounding Block Two Terminals Solid or Stranded Copper Wire 24–10 AWG 6.2 mm (0.24 in.) wide	Green/Yellow	NSYTRP42PE	50	Grey	NSYTRACR42	50
 Grounding Block Three Terminals Solid or Stranded Copper Wire 24–10 AWG 6.2 mm (0.24 in.) wide	Green/Yellow	NSYTRP43PE	50	Grey	NSYTRACP43	50
 Grounding Block Four Terminals Solid or Stranded Copper Wire 24–10 AWG 6.2 mm (0.24 in.) wide	Green/Yellow	NSYTRP44PE	50	Grey	NSYTRACP44	50



File:
E164359
CCN:
XCFR2



File:
702070
Class:
6228-01



RoHS
Compliant

For track and accessories, see [Mounting Track and End Clamps, page 24-15](#).

[25] These maximum current values assume the use of insulated copper conductors with 167 °F (75 °C) temperature rating and are calculated based on NEC Article 310, Table 310-16. In most cases this value is the maximum ampacity of the wire which has the greatest current carrying capacity. The actual allowable current for a particular application depends on the size, insulation class, and other characteristics of the wire used. The UL ratings are shown. The CSA rating may be higher or lower. Refer to the catalog for CSA ratings.

[26] One end-barrier is required for each assembly of like blocks.

[27] Orders must specify the standard package quantity (Std. Pack) or multiples of that quantity.

Double Deck Passthrough, Blade Isolators, Component Carriers

Table 24.26: Push-in Double Deck Passthrough and Grounding Terminal Blocks



Description	Maximum Voltage	Maximum Current [28]	Block			End Barrier [29]		
			Color	Catalog Number	Std. Pack [30]	Color	Catalog Number	Std. Pack [30]
 Double Deck Passthrough Four Terminals Solid or Stranded Copper Wire 26–12 AWG 5.2 mm (0.21 in.) wide	600 V	20 A	Grey	NSYTRP24D	50	Grey	NSYTRACRE24	50
			Blue	NSYTRP24DBL		Grey	NSYTRACRE24	
 Double Deck Grounding Block Four Terminals Solid or Stranded Copper Wire 26–12 AWG 5.2 mm (0.21 in.) wide	N/A	N/A	Green/Yellow	NSYTRP24DPE	50	Grey	NSYTRACRE24	50

Table 24.27: Push-in Blade Isolators





Description	Maximum Voltage	Maximum Current [28]	Block			End Barrier [29]		
			Color	Catalog Number	Std. Pack [30]	Color	Catalog Number	Std. Pack [30]
 Blade Isolator Two Terminals Solid or Stranded Copper Wire 26–12 AWG 5.2 mm (0.21 in.) wide	300 V	20 A	Grey	NSYTRP22SC	50	Grey	NSYTRACPK22	50
 Blade Isolator Three Terminals Solid or Stranded Copper Wire 26–12 AWG 5.2 mm (0.21 in.) wide	300 V	20 A	Grey	NSYTRP23SC	50	Grey	NSYTRACPK23	50
 Blade Isolator Four Terminals Solid or Stranded Copper Wire 26–12 AWG 5.2 mm (0.21 in.) wide	300 V	20 A	Grey	NSYTRP24SC	50	Grey	NSYTRACPK24	50

Table 24.28: Push-In Type Component Carriers

Description	Maximum Voltage	Maximum Current [28]	Color	Catalog Number	Std. Pack [30]	End Barrier [29]		
						Color	Catalog Number	Std. Pack [30]
 Component Carrier Two Terminals Solid or Stranded Copper Wire 26–12 AWG 5.2 mm (0.21 in.) wide	300 A	20 A	Grey	NSYTRP22TB	50	Grey	NSYTRACPK22	50
			Depends on fuse or diode used	Black	NSYTRASF520	10	Not required	
				Black	NSYTRASF520M	10		
				Black	NSYTRASF520B	10		
				Black	NSYTRASF520V	10		
Grey	NSYTRASV1	10						
With 1N4007 diode	Grey	NSYTRASV2	10					
 Component Carrier Two Terminals Solid or Stranded Copper Wire 24–12 AWG 6.2 mm (0.24 in.) wide	300 A	20 A	Grey	NSYTRP42TB	50	Grey	NSYTRACR42	50
			Depends on fuse or diode used	Black	NSYTRASF520	10	Not required	
				Black	NSYTRASF520M	10		
				Black	NSYTRASF520B	10		
				Black	NSYTRASF520V	10		
Grey	NSYTRASV1	10						
With 1N4007 diode	Grey	NSYTRASV2	10					

 File:
E87739
CCN:
XCFR2

 File:
256444
Class:
6228-01

 RoHS
Compliant

 For track and accessories, see [Mounting Track and End Clamps](#), page 24-15.





[28] These maximum current values assume the use of insulated copper conductors with 167 °F (75 °C) temperature rating and are calculated based on NEC Article 310, Table 310-16. In most cases this value is the maximum ampacity of the wire which has the greatest current carrying capacity. The actual allowable current for a particular application depends on the size, insulation class, and other characteristics of the wire used. The UL ratings are shown. The CSA rating may be higher or lower. Refer to the catalog for CSA ratings.

[29] One end-barrier is required for each assembly of like blocks.

[30] Orders must specify the standard package quantity (Std. Pack) or multiples of that quantity.

Linery Marking Accessories

Table 24.29: Markers

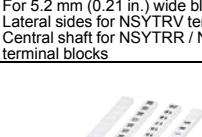
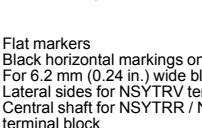
Description	Marking	Catalog Number	Std Pack ^[31]
 <p>Black horizontal markings on white background For 5.2 mm (0.21 in.) wide blocks Lateral sides for NSYTRV terminal blocks Central shaft for NSYTRR / NSYTRP / NSYTRH terminal blocks</p>	1 to 10	NSYTRAB510	10
	11 to 20	NSYTRAB520	10
	21 to 30	NSYTRAB530	10
	31 to 40	NSYTRAB540	10
	41 to 50	NSYTRAB550	10
	51 to 60	NSYTRAB560	10
	61 to 70	NSYTRAB570	10
	71 to 80	NSYTRAB580	10
	81 to 90	NSYTRAB590	10
	91 to 100	NSYTRAB5100	10
	1 to 100	NSYTRAB51100	1
 <p>Black horizontal markings on white background For 6.2 mm (0.24 in.) wide blocks Lateral sides for NSYTRV terminal blocks Central shaft for NSYTRR / NSYTRP / NSYTRH terminal blocks</p>	L1, L2, L3, N, PE	NSYTRAB5L1N	10
	1 to 10	NSYTRAB610	10
	11 to 20	NSYTRAB620	10
	21 to 30	NSYTRAB630	10
	31 to 40	NSYTRAB640	10
	41 to 50	NSYTRAB650	10
	51 to 60	NSYTRAB660	10
	61 to 70	NSYTRAB670	10
	71 to 80	NSYTRAB680	10
	81 to 90	NSYTRAB690	10
	91 to 100	NSYTRAB6100	10
1 to 100	NSYTRAB61100	1	
 <p>Black horizontal markings on white background For 8.2 mm (0.32 in.) wide blocks Lateral sides for NSYTRV terminal blocks Central shaft for NSYTRR / NSYTRP / NSYTRH terminal blocks</p>	L1, L2, L3, N, PE	NSYTRAB6L1N	10
	1 to 10	NSYTRAB810	10
	11 to 20	NSYTRAB820	10
	21 to 30	NSYTRAB830	10
	31 to 40	NSYTRAB840	10
	41 to 50	NSYTRAB850	10
	51 to 60	NSYTRAB860	10
	61 to 70	NSYTRAB870	10
	71 to 80	NSYTRAB880	10
	81 to 90	NSYTRAB890	10
	91 to 100	NSYTRAB8100	10
1 to 100	—	—	
 <p>Black horizontal markings on white background Lateral sides for NSYTRV terminal blocks Central shaft for NSYTRR / NSYTRP / NSYTRH terminal block</p>	L1, L2, L3, N, PE	—	—
	1 to 10	NSYTRAB1010	10
	11 to 20	NSYTRAB1020	10
	21 to 30	NSYTRAB1030	10
	31 to 40	NSYTRAB1040	10
	41 to 50	NSYTRAB1050	10
	51 to 60	NSYTRAB1060	10
	61 to 70	NSYTRAB1070	10
	71 to 80	NSYTRAB1080	10
	81 to 90	NSYTRAB1090	10
	91 to 100	NSYTRAB10100	10
1 to 100	—	—	
 <p>Flat markers Black horizontal markings on white background Lateral sides for NSYTRV terminal blocks Central shaft for NSYTRR / NSYTRP / NSYTRH terminal block</p>	L1, L2, L3, N, PE	—	—
	1 to 10	NSYTRABF510	10
	11 to 20	NSYTRABF520	10
	21 to 30	NSYTRABF530	10
	31 to 40	NSYTRABF540	10
	41 to 50	NSYTRABF550	10
	51 to 60	—	—
	61 to 70	—	—
	71 to 80	—	—
	81 to 90	—	—
	91 to 100	—	—
1 to 100	—	—	
 <p>Flat markers Black horizontal markings on white background For 5.2 mm (0.21 in.) wide blocks Lateral sides for NSYTRV terminal blocks Central shaft for NSYTRR / NSYTRP / NSYTRH terminal blocks</p>	L1, L2, L3, N, PE	—	—
	1 to 10	NSYTRABF610	10
	11 to 20	NSYTRABF620	10
	21 to 30	NSYTRABF630	10
	31 to 40	NSYTRABF640	10
	41 to 50	NSYTRABF650	10
	51 to 60	—	—
	61 to 70	—	—
	71 to 80	—	—
	81 to 90	—	—
	91 to 100	—	—
1 to 100	—	—	
 <p>Flat markers Black horizontal markings on white background For 6.2 mm (0.24 in.) wide blocks Lateral sides for NSYTRV terminal blocks Central shaft for NSYTRR / NSYTRP / NSYTRH terminal block</p>	L1, L2, L3, N, PE	—	—

NOTE: Refer to catalog 9080CT1301 for additional labeling options.

[31] For blocks 12.2 mm (0.48 in.) or wider, the strip must be broken and the individual marking characters used.

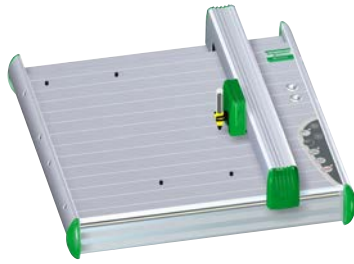





NSYTRAPLOT

Linergy Labeling System

This high-speed plotting device enables custom marking of Linergy IEC terminal block labels.

- A flexible plotter that labels marking elements quickly and easily
- Rugged construction in stylish aluminum
- Easy-to-change fixtures to suit a variety of marking elements
- Auto calibration, no adjustment necessary
- Includes NSYTRA BMP1/ BMP2 adapter plates, 0.25 and 0.35 black pens, Spacial print software, power supply, connecting cable, and user manual.

Table 24.30: Blank Markers

Description	Catalog Number	Std. Pack	
 Blank marking cards for 5.2 mm (0.21 in.) wide blocks	72 characters (6 strips)	NSYTRABPV5	10
	Plotter adapter for marking cards	NSYTRABMP1	1
 Blank marking cards for 6.2 mm (0.24 in.) wide blocks	60 characters (6 strips)	NSYTRABPV6	10
	Plotter adapter for marking cards	NSYTRABMP1	1
 Blank marking cards for 8.2 mm (0.32 in.) wide blocks	42 characters (6 strips)	NSYTRABPV8	10
	Plotter adapter for marking cards	NSYTRABMP1	1
 Blank flat marking cards for 5.2 mm (0.21 in.) wide blocks	60 characters (6 strips)	NSYTRABFPV5	10
	Plotter adapter for marking cards	NSYTRABMP2	1
 Blank flat marking cards for 6.2 mm (0.24 in.) wide blocks	60 characters (6 strips)	NSYTRABFPV6	10
	Plotter adapter for marking cards	NSYTRABMP2	1





RoHS Compliant

NOTE: Refer to catalog 9080CT1301 for additional labeling options.

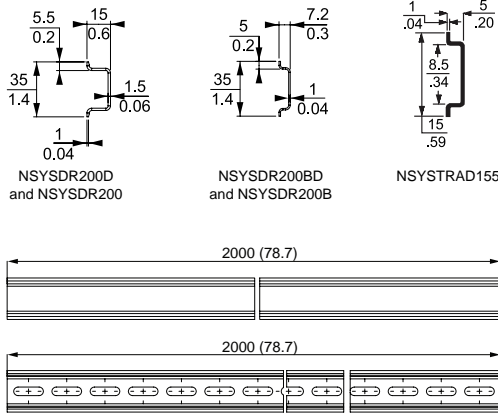
Mounting Track and End Clamps

Table 24.31: DIN 3 Track—78.74 inches (2 meter) length



Description	Length		Catalog Number	Std. Pack [1]
	In.	mm		
DIN 3				
Symmetrical rail 35x15 mm depth, 1.5 mm thick galvanized steel, Prepunched	78.74	2000	NSYSR200D	20
Symmetrical rail 35x15 mm depth, 1.5 mm thick galvanized steel, No mounting holes	78.74	2000	NSYSR200	20
Symmetrical rail 35x7.2 mm depth, 1 mm thick galvanized steel, Prepunched	78.74	2000	NSYSR200BD	20
Symmetrical rail 35x7.2 mm depth, 1 mm thick galvanized steel, No mounting holes	78.74	2000	NSYSR200B	20
DIN 2				
Symmetrical rail 15x5 mm depth, 1 mm thick galvanized steel, Prepunched	78.74	2000	NSYTRADR155	5
End Clamps				
 Plastic clip-on end clamp for 35 mm DIN 3 track	0.21	5.2	NSYTRAAAB35	50
 Plastic clip-on end clamp with screw for 35 mm DIN 3 track	0.37	9.5	NSYTRAAVB35	50
 Plastic clip-on end clamp for 15 mm DIN 2 track	0.21	5.2	NSYTRAAAB15	50
 Polycarbonate end clamp for 35 mm DIN 3 track	0.31	8	9080MHA10	50
RoHS Compliant				

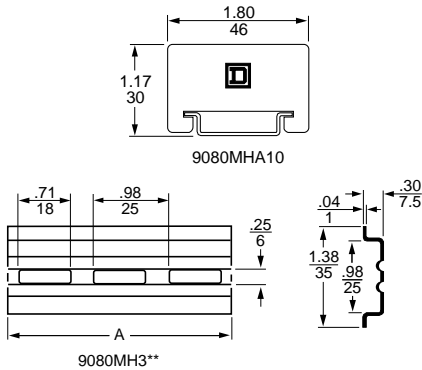









Table 24.32: DIN 3 Track – Various Lengths

Description	Length		Class 9080 Type	Std. [1] Pack	
	In.	mm			
Galvanized steel, no mounting holes	3	0.08	9080MH203	10	
	4	0.10	9080MH204		
	5	0.13	9080MH205		
	6	0.15	9080MH206		
	7	0.18	9080MH207		
	8	0.20	9080MH208		
	9	0.23	9080MH209		
	10	0.25	9080MH210		
	11	0.28	9080MH211		
	12	0.30	9080MH212		
	13	0.33	9080MH213		
	14	0.36	9080MH214		
	15	0.38	9080MH215		
	16	0.41	9080MH216		
	17	0.43	9080MH217		
	18	0.46	9080MH218		
	19.68	500	9080MH220		
	39.37	1000	9080MH239		
	78.74	2000	9080MH279		
	Symmetrical rail 35 x 7.5 mm (1.38 in. x 0.295 in.) in compliance with EN 50022 standard (DIN 46277-3).	3	0.08		9080MH303
4		0.10	9080MH304		
5		0.13	9080MH305		
6		0.15	9080MH306		
7		0.18	9080MH307		
8		0.20	9080MH308		
9		0.23	9080MH309		
10		0.25	9080MH310		
11		0.28	9080MH311		
12		0.30	9080MH312		
13		0.33	9080MH313		
14		0.36	9080MH314		
15		0.38	9080MH315		
16		0.41	9080MH316		
17		0.43	9080MH317		
18		0.46	9080MH318		
19.68		500	9080MH320		
39.37		1000	9080MH339		
78.74	2000	9080MH379			
High rise track	Aluminum	39.37	1000	9080MH439	2

[1] Orders must specify the standard package quantity (Std. Pack) or multiples of that quantity.

Selection Guide

Table 24.33: Type G Selection Guide

Description	Maximum Voltage	Maximum Current [1]	Blocks			End Barriers [2]		Blocks per ft	Maximum Wire Combinations		
			Color	Type	Std. Pack [3]	Type	Std. Pack [3]		Copper Wire (stranded or solid)		
 <p>Solderless Box Lug for #22 to #8 AWG wire. Mounts on standard 9080GH track or 35 mm DIN 3 track. Fingersafe per DIN 57470.</p>	600 V	60 A	Natural	GR6	50	GM6B	10	34	1 #8 1 #10 1-3 #12 1-4 #14	1-4 #16 1-5 #18 1-8 #20 1-10 #22	
			Black	GRB6		GMB6B					
			Blue	GRL6		GML6B					
			Green	GRG6		GMG6B					
			Gray	GRE6		GME6B					
			Orange	GRS6		GMS6B					
			Red	GRR6		GMR6B					
			Yellow	GRY6		GMY6B					
			Brown	GRN6		GMN6B					
 <p>Similar to a 9080GR6 except with a 9080GH91 banana test plug adapter installed. Fingersafe per DIN 57470.</p>	600 V	60 A	Natural	GR6T	50	GM6B	10				
 <p>Solderless Box Lug for #22 to #10 AWG wire. Can be mounted directly to a panel or can be mounted on 9080GH track.</p>	600 V	40 A	Natural	GK6	50	GK6B	50	34	1-4 #16 1 #10 1-2 #12 1-2 #14	1-4 #16 1-5 #18 1-8 #20 1-10 #22	
			Black	GKB6							
			Blue	GKL6							
			Green	GKG6							
			Gray	GKE6							
			Orange	GKS6							
			Red	GKR6							
Yellow	GKY6										
 <p>High Density Solderless Box Lug for #22 to #10 AWG wire. Mounts on standard 9080GH track or 35 mm DIN 3 track. Fingersafe per DIN 57470.</p>	600 V	30 A	Natural	GM6	50	GM6B	10	51	1 #10 1 #12 1 #14 1-2 #16	1-2 #18 1-5 #20 1-8 #22 1-2 #16	
			Black	GMB6		GMB6B					
			Blue	GML6		GML6B					
			Green	GMG6		GMG6B					
			Gray	GME6		GME6B					
			Orange	GMS6		GMS6B					
			Red	GMR6		GMR6B					
			Yellow	GMY6		GMY6B					
			Brown	GMN6		GMN6B					
 <p>Solderless Box Lug for #18 to #4 AWG wire. Mounts on standard 9080GH track or 35 mm DIN 3 track.</p>	600 V	85 A	Natural	GC6	50	GC6B	10	28	1 #4 1 #6 1-2 #8 1-4 #10	1-5 #12 1-6 #14 1-6 #16 1-8 #18	
 <p>Solderless Box Lug for #12 to #10 AWG wire. Mounts on standard 9080GH track or 35 mm DIN 3 track.</p>	600 V	170 A	Natural	GD6	10	GD6B	10	17	1 1/0 1 #1 1 #2 1-2 #4	1-3 #6 1-5 #8 1-6 #10 1-7 #12	
 <p>Solderless Box Lug for #6 AWG to 250 kcmil wire. [4] Mounts on standard 9080GH track or 35 mm DIN 3 track.</p>	600 V	255 A	Natural	GE6	10	None Required		10	1 250 kcmil [4]		
										1 4/0 1 3/0 1 2/0 1 1/0	1 #1 1 #2 1 #4 1 #6

24 TERMINAL BLOCKS



 File: E60616 CCN: XCFR2
 File: 025490 Class:3211-07
 RoHS Compliant

Table 24.34: How to Order

To Order Specify	Catalog Number	
• Class Number	Class	Type
• Type Number	9080	GR6

For standard or custom assemblies, see [Terminal Block Assemblies, page 24-18](#).
 For mounting track and accessories, see [Mounting Track, End Clamps, Jumpers, Fanning Strips, page 24-19](#).
 For DIN 3 track and end clamps, see [Mounting Track and End Clamps, page 24-15](#).

[1] These maximum current values assume the use of insulated copper conductors with 75 °C (167 °F) temperature rating, temperature rating, and are calculated based on NEC Article 310, Table 310-16. In most cases this value is the maximum ampacity of that wire or combination of wires (as listed in the above table) which has the greatest current carrying capacity. The actual allowable current for a particular application depends on the number, size, insulation class, and other characteristics of the wires used. The lower of the UL and CSA ratings are shown.









[2] One end-barrier is required for each assembly of like blocks.

[3] Orders must specify standard package quantity or multiples of that quantity.

[4] Terminals are tin plated, making them suitable for use with either copper or aluminum wire.

Selection Guide

Table 24.35: Type G Selection Guide

Description	Maximum Voltage	Maximum Current [5]	Blocks		End Barriers [6]		Blocks per ft	Maximum Wire Combinations	
			Type	Std. Pack [7]	Type	Std. Pack [7]		Copper Wire (stranded or solid)	
 Self-Lifting Pressure Wire Connector for #18 to #12 AWG wire. Mounts on standard 9080GH track or 35 mm DIN 3 track.	600 V	40 A	GP6	50	GP6B	10	32	1 or 2 1 or 2 1 or 2 1 or 2	#12 #14 #16 #18
 Flat Terminal Connector for #22 to #12 AWG wire. Screws are #6-32 x 5/16 in. for ring or spade lugs, 5/16 in. wide maximum. Mounts on standard 9080GH track or 35 mm DIN 3 track. Fingersafe per DIN 57470.	600 V	40 A	GA6	50	GP6B	10	32	1 or 2 Conductors Per Screw #12-22	
 Circuit Isolating Switch [8] with self-lifting pressure connectors for #18 to #10 AWG wire. Mounts on standard 9080GH track or 35 mm DIN 3 track.	600 V	30 A	GG6	10	GF6B	10	16	1 1 1 1-4 1-4	#10 #12 #14 #16 #18
 Slip-on Connectors for #22 to #12 AWG wire. Tabs accept 0.250 x 0.032 in. slip-on connectors Mounts on standard 9080GH track or 35 mm DIN 3 track.	600 V	20 A	GS6	10	GF6B	10	16	1-2 1-2 1-2 1-2 1-2 1-2	#12 #14 #16 #18 #20 #22
 Transient Voltage Suppressors [9] with box lug connectors for #18 to #10 AWG wire. Mounts on standard 9080GH track or 35 mm DIN 3 track. See the figure below.	120 V	—	GT6	5	GT6B	10	24	1 1 1 1-2 1-4	#10 #12 #14 #16 #18
 Fuse Block for 13/32 in. Dia. x 1-1/2 in. ferrule fuse with self-lifting pressure connectors. Fuse puller is included as standard. Fuses are not included. Mounts on standard 9080GH track or 35 mm DIN 3 track. Fingersafe per DIN 57470.	600 V	30 A	GF6	10	GF6B	10	16	1 1 1 1-4 1-4	#10 #12 #14 #16 #18
 Fuse Puller [10]	—	—	GH63	50	N/A		N/A	N/A	
	120-240 V	—	GLP3	10	N/A		N/A	N/A	
	277-600 V	—	GLP6	10	N/A		N/A	N/A	

24 TERMINAL BLOCKS

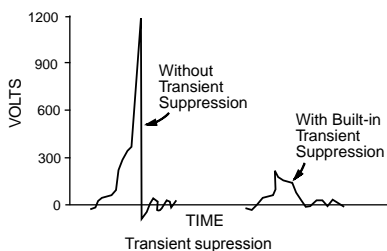

For standard or custom assemblies, see [Terminal Block Assemblies, page 24-18](#).
For mounting track and accessories, see [Mounting Track, End Clamps, Jumpers, Fanning Strips, page 24-19](#).
For DIN 3 track and end clamps, see [Mounting Track and End Clamps, page 24-15](#).

Table 24.36: How to Order

To Order Specify	Catalog Number	
• Class Number	Class	Type
• Type Number	9080	GP6

Terminal Blocks:



File: E60616
CCN: XCFR2



File: 025490
Class: 3211-07



RoHS Compliant

Blown Fuse Indicator:



File: E63698
CCN: JDV5



File: 025490
Class: 3211-07

RoHS Compliant

[5] These maximum current values assume the use of insulated copper conductors with 75 °C (167 °F) temperature rating, and are calculated based on NEC Article 310, Table 310-16. In most cases this value is the maximum ampacity of that wire or combination of wires (as listed in the above table) which has the greatest current carrying capacity. The actual allowable current for a particular application depends on the number, size, insulation class, and other characteristics of the wires used. The lower of the UL and CSA ratings are shown.
[6] One end-barrier is required for each assembly of like sections.
[7] Orders must specify standard package quantity or multiples of that quantity.
[8] Not intended to make or break a live circuit. Power must be disconnected from the circuit before operation of the switch.
[9] Modules have RC circuitry for suppressing transient voltage, generated when opening a coil circuit, to approximately 200% of the peak line voltage, when used with 120 V coils. Type GT6 is suitable for use with Square D Class 8501 Type X, K, R and C relays or Square D Type S starters and contactors, Sizes 00-2.
[10] Fuse puller is supplied as standard with Class 9080 Type GF6 fuse block. The 9080GH63 is a replacement fuse puller.

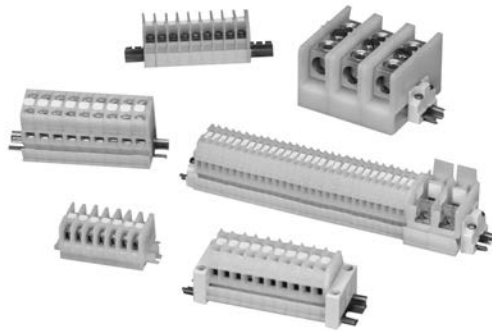

Terminal Block Assemblies

Standard Terminal Block Assemblies

The assemblies listed in the table below consist of 6 ft (two 3 ft lengths packaged together) of terminal blocks. The terminal blocks are mounted on snap-off mounting track, which can be easily broken every 5/16 in. Every tenth terminal block is marked to aid in counting off the proper number of terminal blocks. After adding the proper end barrier and a slip-in end clamp to the blocks that were broken off, the custom assembly is ready for installation.

Table 24.37: Standard Terminal Block Assemblies

Description	Type
Assembly of 188 Type GA6	GA6188BC
Assembly of 204 Type GR6	GR6204BC
Assembly of 94 Type GF6	GF694BC
Assembly of 296 Type GM6	GM6296BC
Assembly of 188 Type GP6	GP6188BC

Custom Terminal Block Assemblies

Order an assembly built as required for the application. As standard, custom assemblies use 9080GH mounting track with screw on end clamps. Other options are available from the table below.

One terminal block type: The number of blocks in the assembly is added to the end of the catalog number of the desired block. Example: an assembly of **25** 9080GR6 blocks would be **9080GR625**.

More than one terminal block type in an assembly: A detailed drawing or sketch of the desired assembly must accompany the order.

Table 24.38: Custom Terminal Block Assembly Options

Option	Suffix	Example
Substitute slip-in end clamps	C	9080GR625C
Substitute snap-off channel	B	9080GR625BC [11]
For direct mount assembly of 9080GK6 blocks	D	9080GK67D
Add a blank vinyl marking strip	M	9080GR625M
Add pre-marked (1–25 only) marking strip	MPO	9080GR625MPO
Mount on 35 mm DIN 3 track instead of 9080GH track	T	9080GR625T



Table 24.39: How to Order

To Order Specify	Catalog Number	
<ul style="list-style-type: none"> Class Number Type Number 	Class	Type
	9080	GA612

[11] The 9080GH10 screw-on end clamp is **not** recommended for use with snap-off channel. It is recommended that the 9080GH11 slip-in end clamp be used. Therefore, when the suffix **B** is used, it should be followed by the suffix **C**.

Mounting Track, End Clamps, Jumpers, Fanning Strips

Table 24.40: 3/4 in. Mounting Track

	Style	Length (in.)	Type	Std. Pack [12]		
 Standard Track	Standard Track	3	GH103	5		
		4	GH104	5		
		5	GH105	5		
		6	GH106	5		
		7	GH107	5		
		8	GH108	5		
		9	GH109	5		
		10	GH110	5		
		11	GH111	5		
		12	GH112	5		
		13	GH113	5		
		14	GH114	5		
		15	GH115	5		
		16	GH116	5		
		17	GH117	5		
		18	GH118	5		
		 Snap-Off Track	Snap-Off Track	36	GH236	20
				48	GH248	20
72	GH272			20		
 High Rise	High Rise	36	GH336	2		

NOTE: For additional track and appropriate end clamps, see [Mounting Track and End Clamps](#), page 24-15.

Table 24.41: End Clamps, Jumpers, and Fanning Strips

Description	Type	Std. Pack [12]	
End Clamps			
 Screw-on End Clamp (Not recommended for use on snap-off mounting track)	GH10	50	
 Slip-in End Clamp (Not for use with 9080 GE6, GK6 blocks)	GH11	50	
Jumpers			
	2-pole jumper for GM6	GH700	20
	6-pole jumper for GM6	GH710	10
	2-pole jumper for GK6, GR6	GH72	20
	6-pole jumper for GK6, GR6	GH73	10
	2-pole jumper for GC6	GH74	10
	6-pole jumper for GC6	GH75	10
	2-pole jumper for GD6	GH76	10
	6-pole jumper for GD6	GH77	10
	2-pole jumper for GA6, GP6	GH78	10
6-pole jumper for GA6, GP6	GH79	10	
Fanning Strips			
 Snap-together fanning strip section for GK6, GR6 blocks	GH52	10	

[12] Orders must specify the standard package quantity (Std. Pack) or multiples of that quantity.

Marking Accessories

Table 24.42: Marking and Additional Accessories











Description	Type	Std. Pack [13]
 25 ft blank vinyl marking strip	GH220	1
 Vinyl marking strip numbered 1-25	For GK6, GR6	GH21 5
	For GA6, GP6	GH22 5
	For GM6	GH230 5
 Blank pin-feed marking tabs—6 x 20 (total 120) marking tabs for GD6, GR6, and GT6 blocks	GH200	20
 Pre-marked 01 to 50 (2 sets) plus 20 various marking tabs (total 120 marking tabs) for GD6, GR6, and GT6 blocks	GH210	5
 Marking strip end plug for GK6, GR6, GM6, GA6, GP6, GC6, GD6, GE6, and GT6 blocks	GH60	50
 Transition barrier between GK6 and all other G blocks	GH61	50
 Cover for GR6 or GR6T blocks	GH62	50
 Banana test plug for GR6T block	GH90	10
 Test plug adapter for GR6T block (included as standard with GR6T)	GH91	50
 Angle bracket kit—for mounting 9080GH or MH track to panel at 45° angle. Includes 2 brackets and hardware for mounting the track to the brackets	MH82	1

Table 24.43: How to Order

To Order Specify	Catalog Number	
<ul style="list-style-type: none"> • Class Number • Type Number 	Class	Type
	9080	GH10

[13] Orders must specify the standard package quantity (Std. Pack) or multiples of that quantity.

Thermal-Magnetic Circuit Protectors

Table 24.44: 9080GCB Thermal-Magnetic Circuit Protectors



GCB100

Maximum Current [1]	Internal Resistance Ω	Maximum Voltage	Catalog Number	
0.1	133	250 Vac 65 Vdc	GCB01	
0.5	6.6		GCB05	
0.8	2.55		GCB08	
1.0	1.97		GCB10	
1.2	1.22		GCB12	
1.5	0.86		GCB15	
2.0	0.49		GCB20	
2.5	0.31		GCB25	
3.0	0.20		GCB30	
4.0	0.10		GCB40	
5.0	0.08		GCB50	
7.0	0.03		GCB70	
10.0	<0.02		125 Vac 65 Vdc	GCB100
15.0	<0.02			GCB150

Table 24.45: Inrush Ratio Correction Table

NOTE: For resistive loads, use inrush correction factor of 1.0.

Inrush Ratio	1:1 to 1:4	1:5	1:6	1:7	1:8
Factor	1.3	1.4	1.5	1.6	1.7

Table 24.46: Ambient Temperature Correction Table

Ambient Temperature	70°F (21.1°C)	100°F (37.8°C)	120°F (48.9°C)	140°F (60°C)	160°F (71.1°C)	180°F (82.2°C)	200°F (93.3°C)
Factor	1.0	1.1	1.2	1.3	1.4	1.5	1.6

Table 24.47: Tripping Times in Seconds at 70 °F (21.1 °C)

NOTE: When several protectors are channel mounted adjacent to each other, the "no trip" current will be 80% of rated current at 70 °F.

Percent Rated Current	100%	200%	300%	400%	500%	600%	1000%	2000% and greater
Tripping Time (s)	no trip	10–40	38	1.5–9	0.8–6	0.003–4	0.003–2	Max. 0.02

Selection

To properly select a Class 9080 Type GCB circuit protector, follow these steps:

- Determine the inrush correction factor from [Table 24.45](#).
- Determine the temperature correction factor from [Table 24.46](#).
- Determine the sealed current of the load that is being protected.
- Multiply the sealed current by the two correction factors and choose the closest circuit protector.

NOTE: Choosing a circuit protector with a value lower than the calculated value might cause nuisance tripping, while choosing the larger might provide a protector that will not properly protect the load .



File: E233026
CCN:QVNU2



File: 025490
Class: 3211-07



Example: Solenoid with sealed current of 0.75 A, an inrush ratio of 1:6, and in an ambient temperature of 85°F: 0.75 x 1.5 x 1.05 = 1.18. Choose the 1.2 A protector.

Tripping Time: Tripping time of the circuit protector is determined from [Table 24.47](#). Divide the circuit protector value by the temperature correction factor from [Table 24.46](#) to determine actual rated current referenced in [Table 24.47](#).

Table 24.48: How to Order

To Order Specify	Catalog Number	
• Class Number	Class	Type
• Type Number	9080	GH10

[1] These maximum current values assume the use of insulated copper conductors with 167 °F (75 °C) temperature rating and are calculated based on NEC Article 310, Table 310-16. In most cases this value is the maximum ampacity of the wire which has the greatest current carrying capacity. The actual allowable current for a particular application depends on the size, insulation class, and other characteristics of the wire used. The UL ratings are shown. The CSA rating may be higher or lower. Refer to the catalog for CSA ratings.

Thermal-Magnetic Circuit Protectors

Table 24.49: GB2 Thermal-Magnetic Circuit Protectors



GB2CB06

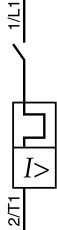
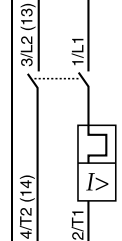

GB2CD

Description	Max. Voltage	Thermal Rating	Catalog Number [1]	Description	Max. Voltage	Thermal Rating	Catalog Number [1]
One pole Thermal Magnetic Circuit Protector 	300 Vac	0.5 A	GB2CB05	Two pole Thermal Magnetic Circuit Protector 	300 Vac	0.5 A	GB2CD05
		1 A	GB2CB06			1 A	GB2CD06
		2 A	GB2CB07			2 A	GB2CD07
		3 A	GB2CB08			3 A	GB2CD08
		4 A	GB2CB09			4 A	GB2CD09
		5 A	GB2CB10			5 A	GB2CD10
		6 A	GB2CB12			6 A	GB2CD12
		8 A	GB2CB14			8 A	GB2CD14
		10 A	GB2CB16			10 A	GB2CD16
						12 A	GB2CB20



File: E113720
CCN:QVNU2



File: 081630
Class: 3215-30



IEC 157-1
VDE 0660

[1] Must order in multiples of 6.

- Finger safe from the front, for isolation of live parts
- Up to 760 A, to meet a wide range of application needs
- Short-Circuit Current Rating up to 100 kA with fuses, not limited by the 10 kA default
- Panel or 35 mm DIN rail mount, for application flexibility
- Gangable to create multipole configurations
- Flexible stranded wire compliant, expands usability
- The UL Listed blocks meet feeder circuit spacing requirements.
- For the short-circuit current ratings, wire classes, tightening torques, dimensions, and more, see the catalog.



NSYEBAD11611



NSYEBAD12611



NSYEBAP13618



NSYEBP2

Enclosed Power Distribution Blocks

Table 24.50: Power Distribution Blocks with AL Lugs (accepts CU or AL conductors)

Wire Range		Mounting	Current Rating	Type
Line Side	Load Side			
CU (1) 14-2 AWG (2.5-35 mm ²)	CU (1) 14-2 AWG (2.5-35 mm ²)	35 mm DIN rail or panel mount	CU 115A	NSYEBAD11611
CU (1) 14-2 AWG (2.5-35 mm ²)	CU (4) 14-10 AWG (2.5-6 mm ²)	35 mm DIN rail or panel mount	CU 115A	NSYEBAD11614
CU (1) 14 AWG-3/0 (2.5-70 mm ²) AL (1) 6 AWG-3/0	CU (1) 14 AWG-3/0 (2.5-70 mm ²) AL (1) 6 AWG-3/0	35 mm DIN rail	CU 200 A AL 155 A	NSYEBAD12611
CU (1) 14 AWG-3/0 (2.5-70 mm ²) AL (1) 6 AWG-3/0	CU (1) 14 AWG-3/0 (2.5-70 mm ²) AL (1) 6 AWG-3/0	Panel mount	CU 200 A AL 155 A	NSYEBAP12611
CU (1) 14 AWG-3/0 (2.5-70 mm ²) AL (1) 6 AWG-3/0	CU (4) 14-2 AWG (2.5-35 mm ²) AL (4) 6-2 AWG	35 mm DIN rail	CU 200 A AL 155 A	NSYEBAD12614
CU (1) 14 AWG-3/0 (2.5-70 mm ²) AL (1) 6 AWG-3/0	CU (4) 14-2 AWG (2.5-35 mm ²) AL (4) 6-2 AWG	Panel mount	CU 200 A AL 155 A	NSYEBAP12614
CU (1) 6 AWG-400 kcmil (16-185 mm ²) CU (1) 14 AWG-3/0 (2.5-70 mm ²) AL (1) 6 AWG-400 kcmil AL (1) 6 AWG-3/0	CU (8) 14-2 AWG (2.5-35 mm ²) AL (8) 6-2 AWG	35 mm DIN rail	CU 335 A AL 270 A	NSYEBAD13618
CU (1) 6 AWG-400 kcmil (16-185 mm ²) CU (1) 14 AWG-3/0 (2.5-70 mm ²) AL (1) 6 AWG-400 kcmil AL (1) 6 AWG-3/0	CU (8) 14-2 AWG (2.5-35 mm ²) AL (8) 6-2 AWG	Panel mount	CU 335 A AL 270 A	NSYEBAP13618
CU (2) 6 AWG-250 kcmil (16-120 mm ²) AL (2) 6 AWG-250 kcmil	CU (2) 6 AWG-250 kcmil (16-120 mm ²) AL (2) 6 AWG-250 kcmil	35 mm DIN rail	CU 510 A AL 410 A	NSYEBAD25622
CU (2) 6 AWG-250 kcmil (16-120 mm ²) AL (2) 6 AWG-250 kcmil	CU (2) 6 AWG-250 kcmil (16-120 mm ²) AL (2) 6 AWG-250 kcmil	Panel mount	CU 510 A AL 410 A	NSYEBAP25622
CU (2) 4 AWG-500 kcmil (25-240 mm ²) AL (2) 4 AWG-500 kcmil	CU (2) 4 AWG-500 kcmil (25-240 mm ²) AL (2) 4 AWG-500 kcmil	Panel mount	CU 760 A AL 620 A	NSYEBAD27622
CU (2) 4 AWG-500 kcmil (25-240 mm ²) AL (2) 4 AWG-500 kcmil	CU (8) 14 AWG-2/0 (2.5-50 mm ²) AL (8) 6 AWG-2/0 kcmil	Panel mount	CU 760 A AL 620 A	NSYEBAP27628

Table 24.51: Power Distribution Blocks with CU Lugs (accepts only CU conductors)

Wire Range		Mounting	Current Rating	Type
Line Side	Load Side			
CU (1) 14 AWG-3/0 (2.5-70 mm ²)	CU (1) 14 AWG-3/0 (2.5-70 mm ²)	35 mm DIN rail	CU 200 A	NSYEBAD12611
CU (1) 14 AWG-3/0 (2.5-70 mm ²)	CU (1) 14 AWG-3/0 (2.5-70 mm ²)	Panel mount	CU 200 A	NSYEBAP12611
CU (1) 14 AWG-3/0 (2.5-70 mm ²)	CU (4) 14-2 AWG (2.5-35 mm ²)	35 mm DIN rail	CU 200 A	NSYEBAD12614
CU (1) 14 AWG-3/0 (2.5-70 mm ²)	CU (4) 14-2 AWG (2.5-35 mm ²)	Panel mount	CU 200 A	NSYEBAP12614
CU (1) 6 AWG-400 kcmil (16-185 mm ²) CU (1) 14 AWG-3/0 (2.5-70 mm ²)	CU (8) 14-2 AWG (2.5-35 mm ²)	35 mm DIN rail	CU 335 A	NSYEBAD13618
CU (1) 6 AWG-400 kcmil (16-185 mm ²) CU (1) 14 AWG-3/0 (2.5-70 mm ²)	CU (8) 14-2 AWG (2.5-35 mm ²)	Panel mount	CU 335 A	NSYEBAP13618
CU (2) 6 AWG-250 kcmil (16-120 mm ²)	CU (2) 6 AWG-250 kcmil (16-120 mm ²)	35 mm DIN rail	CU 510 A	NSYEBAD25622
CU (2) 6 AWG-250 kcmil (16-120 mm ²)	CU (2) 6 AWG-250 kcmil (16-120 mm ²)	Panel mount	CU 510 A	NSYEBAP25622
CU (2) 4 AWG-500 kcmil (25-240 mm ²)	CU (8) 14 AWG-2/0 (2.5-50 mm ²)	Panel mount	CU 760 A	NSYEBAD27628

Table 24.52: Terminal Plugs (for plugging unused openings)

Plug Size	For use with	Type
2 AWG	NSYEB**13618	NSYEBP2
2/0	NSYEB**13618, NSYEB**27628	NSYEBP20
250 kcmil	NSYEB**25622	NSYEBP250
400 kcmil	NSYEB**13618	NSYEBP400
500 kcmil	NSYEBAP27622, NSYEB**27628	NSYEBP500



UL E323110 QPQS
All except
NSYEB**13618 and
NSYEB**25622



File: 70361
Class: 6228-01

RoHS
Compliant



UL E60616 XCFR2
NSYEB**13618
NSYEB**25622



CE Marked

UL 94V-0 flammability rating

Open Power Distribution Blocks

Table 24.53: Aluminum Power Distribution Blocks



LBA365212



LBA161104



LBC165212

Lug Wire Range [1]		Aluminum [2]		
Main	Branch	One Pole	Two Pole	Three Pole
		Type	Type	Type
(1) #14-2/0	(1) #14-2/0	LBA162101	LBA262101	LBA362101
(1) #6-350 kcmil	(1) #6-350 kcmil	LBA163101	LBA263101	LBA363101
(1) #4-600 kcmil	(1) #4-600 kcmil	LBA164101	N/A	LBA364101
(2) #4-350 kcmil	(2) #4-350 kcmil	LBA165202	LBA265202	LBA365202
(2) #6-500 kcmil	(2) #4-500 kcmil	LBA1652021	LBA2652021	LBA3652021
(1) #14-2/0	(4) #14-4	LBA162104	LBA262104	LBA362104
(1) #14-2/0	(6) #14-4	N/A	N/A	LBA362106
(1) #6-400 kcmil	(4) #14-2	LBA163104	LBA263104	LBA363104
(1) #6-400 kcmil	(6) #14-2	LBA163106	LBA263106	LBA363106
(1) #6-400 kcmil	(8) #14-2	LBA164108	LBA264108	LBA364108
(1) #4-500 kcmil	(6) #14-2/0	LBA165106	LBA265106	LBA365106
(1) #4-500 kcmil	(12) #14-2	LBA165112	LBA265112	LBA365112
(2) #14-2/0	(6) #14-4	LBA163206	LBA263206	LBA363206
(2) #6-500 kcmil	(8) #14-2/0	LBA165208	LBA265208	LBA365208
(2) #6-500 kcmil	(12) #14-4	LBA165212	LBA265212	LBA365212

Table 24.54: Miniature Aluminum Power Distribution Blocks

Lug Wire Range [1]		Aluminum [2]		
Main	Branch	One Pole	Two Pole	Three Pole
		Type	Type	Type
(1) #14-2	(1) #14-2	LBA161101	N/A	LBA361101
(1) #14-2	(4) #18-10	LBA161104	LBA261104	LBA361104

Table 24.55: Copper Power Distribution Blocks

Lug Wire Range [1]		Copper [3]		
Main	Branch	One Pole	Two Pole	Three Pole
		Type	Type	Type
(1) #18-1/0	(1) #18-1/0	LBC162101	N/A	LBC362101
(1) #6-250 kcmil	(1) #6-250 kcmil	LBC163101	N/A	LBC363101
(1) #14-2/0	(4) #14-4	LBC162104	LBC262104	LBC362104
(1) #4-500 kcmil	(6) #14-2	LBC163106	LBC263106	LBC363106
(2) #14-2/0	(6) #14-4	LBC163206	LBC263206	LBC363206
(2) #4-500 kcmil	(8) #14-2/0	LBC165208	N/A	LBC365208
(2) #6-500 kcmil	(12) #14-2	LBC165212	N/A	LBC365212



File: E60616
CCN: XCFR2



File: 70361
Class: 6228-01



RoHS
Compliant

Table 24.56: Clear Plastic Covers (0.045 in. thick)

For LBA Type [4]	Type	Dim. A	Dim. B
LBA161...	LB11	0.824	2.31
LBA261...	LB12	1.459	2.31
LBA361	LB13	2.094	2.31
LBA162..., LBC162	LB21	1.062	2.750
LBA262..., LBC262	LB22	1.875	2.750
LBA362..., LBC362 [5]	LB23	2.688	2.750
LBA163..., LBC163	LB31	1.782	3.813
LBA263..., LBC263	LB32	3.313	3.813
LBA363..., LBC363	LB33	4.844	3.813
LBA164...	LB41	2.125	4.563
LBA264...	LB42	4.000	4.563
LBA364...	LB43	5.875	4.563
LBA165..., LBC165	LB51	2.719	5.313
LBA265..., LBC265	LB52	5.656	5.313
LBA365..., LBC365	LB53	8.375	5.313

Table 24.57: How to Order

To Order Specify	Catalog Number
• Class Number	9080
• Type Number	LBA162101

Application Information

Voltage Rating-Class B and C-600 V

Blocks are rated based on NEC Table 310-16 using 167 °F (75 °C) wire

Aluminum blocks are tin-plated high conductive aluminum. Copper blocks are tin-plated high conductive copper.

Housing material:

- Miniature Blocks are made from high impact thermoplastic rated at 257 °F (125 °C) max. and -40 °F (-40 °C) min.
- Full Size Blocks are made from general purpose phenolic rated at 302 °F (150 °C) max. and -40 °F (-40 °C) min.

All blocks have a flammability rating of UL 94V-0.

For the short-circuit current ratings and dimensions, see catalog 9080CT9603.

[1] Lugs suitable for use with 75 °C (167 °F) conductors.

[2] Aluminum blocks will accept either aluminum or copper conductors.

[3] Copper blocks will accept copper conductors only.

[4] These covers must be ordered in multiples of 5. Each cover comes with two self-tapping screws.

[5] Will not work on a 9080LBA362106 block.

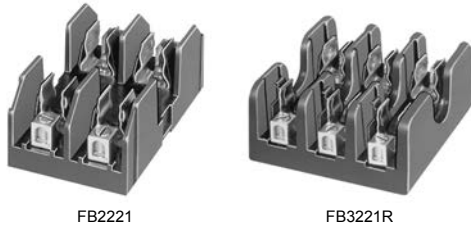

FB2221

FB3221R

Application Information

Clip material:

- All 30 and 60 A fuse clips are copper alloy tin plated.
- All 100 and 200 A fuse clips are one piece aluminum with copper spring tin plated.
- All Class H, R and J fuses are standard with reinforced fuse clips.

Lug termination:

- All 30 A blocks have pressure wire connectors.
- All 60, 100 and 200 A blocks have box lug connectors.

Fuseholders and Track Adapter

Table 24.58: 250 V—Classes H and R

Rating (A) [1]	No. of Poles	Class H	Class R [2][3]	Lug Wire Range
		Type	Type	
30[4]	1	FB1211	FB1211R	#14–10 Cu
	2	FB2211	FB2211R	
	3	FB3211	FB3211R	
60[4]	1		FB1221R	#14–2 Cu or Al
	2		FB2221R	

Table 24.59: 600 V—Classes H and R

Rating (A) [1]	No. of Poles	Class H	Class R [2][3]	Lug Wire Range
		Type	Type	
30[5]	1	FB1611		#14–10 Cu
	2	FB2611	FB2611R	
	3	FB3611	FB3611R	
60[5]	1		FB1621R	#14–2 Cu or Al
	3		FB3621R	
100[5]	3		FB3631R	#6–2/0 Cu or Al

Table 24.60: 600 V Series—Miniature Fuse Dimension (13/32 x 1-1/2 in.)

Rating (A) [1]	No. of Poles	Type M	Class CC [2][3]	Lug Wire Range
		Type	Type	
30[4]	1	FB1611M	FB1611CC	#14–10 Cu
	2	FB2611M	FB2611CC	
	3	FB3611M	FB3611CC	

Table 24.61: 600 V—Class H Only (Copper Only)

Rating (A) [1]	No. of Poles	Class H	Lug Wire Range
		Type	
30[5]	1	FB1611	#14–10 Cu
	2	FB2611	
	3	FB3611	
100[5]	3	FB3631C	#6–2/0 Cu

Table 24.62: 600 V—Class J

Rating (A) [1]	No. of Poles	Class J [2]	Lug Wire Range
		Type	
30[5]	2	FB2611J	#2–14 AWG Cu–Al
	3	FB3611J	
60[5]	2	FB2621J	#2–14 Cu–Al
	3	FB3621J	

Table 24.63: Track Adapter





Description	Type	Std. Pack [6]
 35 mm DIN 3 Track Adapter For 9080 FB*211, FB*211R, FB*611M, and FB*611CC Fuseholders	FBDIN3	100

Table 24.64: Fuse Sizes—(Diameter x Length)

A	Class of Fuse			
	Class H/R—300 V	Class H/R—600 V	Class M/CC—600 V	Class J—600 V
30	9/16 x 2 in.	13/16 x 5 in.	13/32 x 1-1/2 in.	13/16 x 2-1/4 in.
60	13/16 x 3 in.	1-1/16 x 5-1/2 in.	N/A	1-1/16 x 2-3/8 in.
100	1 x 7-7/8 in.	1 x 7-7/8 in.	N/A	N/A
200	1-1/2 x 7-1/8 in.	1-3/4 x 9-5/8 in.	N/A	N/A

	File: E40747 CCN: IZLT2	Type M fuseholders
	File: E40747 CCN: IZLT	Types H, R, J, and CC
	File: 70360 Class: 6225–01	

Flammability rating of all FB fuse blocks is UL 94V-0. RoHS Compliant

Table 24.65: How to Order

To Order Specify	Catalog Number
• Class Number	9080
• Type Number	FB1211

[1] Specified wire ranges are based on 167 °F (75 °C) wire. Wires with temperature ratings other than 167 °F (75 °C) are approved while observing NEC Article 310 wire tables for allowable ampacities of insulated conductors.

[2] Class R, J and CC fuse blocks are tested and approved for 200,000 AIC in accordance with UL 512.

[3] Class R and CC fuseholders accept current limiting Class R & CC fuses only.

[4] Base is high impact thermoplastic—maximum operating temperature 257 °F (125 °C).

[5] Base is general purpose phenolic—maximum operating temperature 302 °F (150 °C).

[6] Orders must specify the standard package quantity (Std. Pack) or multiples of that quantity.



DFCC1 (Left) and DFCC3V (Right)

Modular Fuseholders

Table 24.66: Modular Fuse Holders, TeSys DF [1]

Rated Thermal Current	Type of Fuse	Composition	Blown Fuse Indicator	Standard Pack Quantity	Catalog Number
30 A	Class CC	1 Pole	No	1 Pole	DFCC1
			Yes		DFCC1V
		2 Pole	No	2 Pole	DFCC2
			Yes		DFCC2V
		3 Pole	No	3 Pole	DFCC3
			Yes		DFCC3V

 File: E310269, CCN: IZLT

[1] For additional fuse holders and information, refer to Catalog 9080CT0801.

With and Without Marking Flags, Dual Wire

Conform to NF C 63-023 Standard
Mark and terminate wires simultaneously

Strip the wire, insert it into the cable end and crimp it.
Up to 7 markers can be used.

Table 24.67: Without Marking Flag

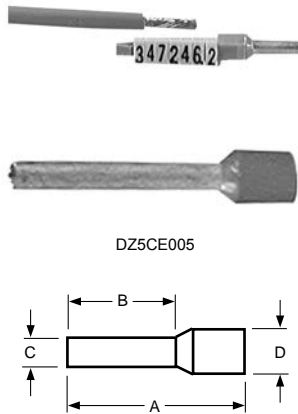

Wire Size AWG	Wire Size mm ²	Sleeve color	Dimensions (mm)				Catalog Number [1][2]	Std. Pack [3]
			A	B	C	D		
26	0.25	Yellow	11	6.2	1.2	2.2	DZ5CE002L6	1000
			13	8.2			DZ5CE002	
24	0.34	Green	11	6.2	1.2	2.2	DZ5CE003L6	
			13	8.2			DZ5CE003	
22	0.50	White	11	6.2	1.4	3	DZ5CE005L6[4]	
			13	8.2			DZ5CE005[4]	
			16.8	12			DZ5CE005L12	
20	0.75	Blue	11	6.2	1.6	3.1	DZ5CE007L6[4]	
			13	8.2			DZ5CE007[4]	
18	1.00	Red	11.5	6.2	1.8	3.4	DZ5CE010L6[4]	
			13.5	8.2			DZ5CE010[4]	
			16.8	12			DZ5CE010L12	
16	1.50	Black	11.5	6.2	2.1	4	DZ5CE015L6[4]	
			13.5	8.2			DZ5CE015[4]	
			22.8	17.7			DZ5CE0153[4]	
14	2.00	Yellow	14.5	8.2	2.35	4.2	DZ5CE020	
14	2.50	Gray	14.5	8.2	2.7	4.6	DZ5CE025[4]	
			24	17.7			DZ5CE0253[4]	
12	4.00	Orange	17.3	9.8	3.3	5.5	DZ5CE042[4]	
			25.5	17.5			DZ5CE043[4]	
10	6.00	Green	20	11.5	3.95	7	DZ5CE062	
			26	17.5			DZ5CE063	

Table 24.68: With Marking Flag

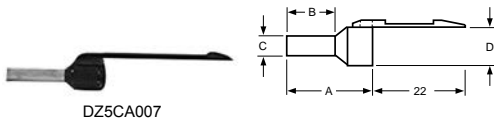

26	0.25	Yellow	13	8.2	1.2	2.2	DZ5CA002	1000
24	0.34	Green			1.4	3	DZ5CA005[4]	
22	0.50	White	13.5	1.8	3.4	DZ5CA010[4]		
20	0.75	Blue				2.1	4	
18	1.00	Red	14.5	2.7	4.6	DZ5CA025[4]		
16	1.50	Black				14.5	8.2	
14	2.50	Gray	14.5	8.2	2.7	4.6	DZ5CE025[4]	

Table 24.69: Marking Flag Optional [5]

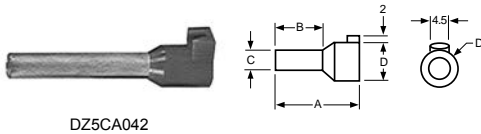

12	4.00	Orange	19.5	11.5	3.3	5.5	DZ5CA042[4]	1000
			25.5	17.5	3.3	5.5	DZ5CA043[4]	
10	6.00	Green	20	11.5	3.95	7	DZ5CA062	100
			26	17.5	3.95	7	DZ5CA063	
8	10.00	Brown	21.5	12	4.95	8.4	DZ5CA102	100
			27	17.5	4.95	8.4	DZ5CA103	
6	16.00	White	23.5	12	6.35	9.8	DZ5CA162	100
			29	17.5	6.35	9.8	DZ5CA163	
4	25.00	Black	30	17.5	8.15	12	DZ5CA253	100
			39	16	9	13.5	DZ5CA352	
2	35.00	Red	39	25	9	13.5	DZ5CA353	20
			36	20	11	15.7	DZ5CA502	
0	50.00	Blue	41	25	11	15.7	DZ5CA503	20

Table 24.70: Dual Wire Cable Ends

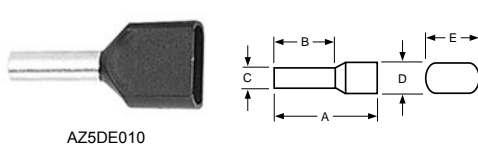

Wire Size	Wire Size	Sleeve	A	B	C	D	E	Catalog Number	Std. Pack
22	0.50	White	13	8	1.4	2.5	4.7	AZ5DE005	500
20	0.75	Blue			1.6	2.8	5.0	AZ5DE007	
18	1.00	Red	13.5	8	1.8	3.4	5.4	AZ5DE010	
16	1.50	Black			2.1	3.6	6.6	AZ5DE015	
14	2.50	Gray	24	10	2.7	4.2	7.8	AZ5DE025	

RoHS Compliant

[1] **Bold faced** catalog numbers are stocked in the United States.
 [2] CE Marked.
 [3] Orders must specify the standard package quantity (Std. Pack) or multiples of that quantity.
 [4] These catalog numbers are UL Component Recognized (File E164872 CCN ZMMT2) provided the AT1PA crimping tool is used to crimp the cable end.
 [5] Will accept an AR1SC03 cable marker.

Cable End Markers and Tools

Table 24.71: Cable End Markers & Accessories

Style	Catalog Number	Std. Pack [6]
Adjustable collar type marker holder for #14 to #2 wire	AR1SC01	100
Clip-on marker holder for #18 to #16 wire (7 markers max.)	AR1SC02	
Cable end marker tags for DZ5CA042 to DZ5CA253	AR1SC03	
Card of 200 yellow markers with black numeral 0 thru 9	AR1MA01[7]	1
Card of 200 yellow markers with black letters A thru Z	AR1MB01 [7]	1
Card of 200 black markers with a white 0 marked on them	AR1MC010	200
Card of 200 brown markers with a white 1 marked on them	AR1MC011	200
Card of 200 red markers with a black 2 marked on them	AR1MC012	200
Card of 200 orange markers with a black 3 marked on them	AR1MC013	200
Card of 200 yellow markers with a black 4 marked on them	AR1MC014	200
Card of 200 green markers with a black 5 marked on them	AR1MC015	200
Card of 200 blue markers with a black 6 marked on them	AR1MC016	200
Card of 200 violet markers with a black 7 marked on them	AR1MC017	200
Card of 200 gray markers with a black 8 marked on them	AR1MC018	200
Card of 200 white markers with a black 9 marked on them	AR1MC019	200
Card of 200 blank yellow markers	AR1MA0196	1
Card of 200 blank green markers	AR1MA0197	1
Card of 200 yellow markers with a black + marked on them	AR1MA0198	1
Card of 200 yellow markers with a black —marked on them	AR1MA0199	1
Complete set of numeral markers 0 thru 9, plus one card each of the "+", "-", yellow blanks, and green blanks/one AT1PA1 positioning tool. Each kit has 200 of each item.	AR1MA01	1
Complete set of letter markers A thru Z, plus one card each of the "+", "-", yellow blanks, and green blanks/one AT1PA1 positioning tool. Each kit has 200 of each item.	AR1MB01	1

Table 24.72: Cable End Tools

Description	Catalog Number
Cable end marker positioning tool	AT1PA1
Automatic stripping and cutting tool for 0.8 mm to 4 mm cable, adjustable stripping length	AT1PA7
Crimping tool for cable ends 0.5 mm ² to 16 mm ²	AT1PA2
Crimping tool for cable ends 10 mm ² to 35 mm ²	AT1PA4
Organizing case for cable ends—holds stripping tool and cable ends (not supplied)	AT1HB2



AR1SC01



AR1SC02



AR1SC03

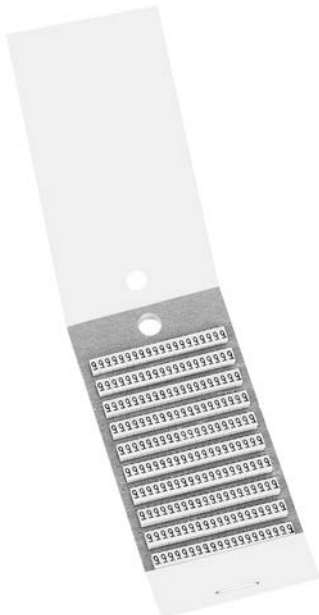

AR1MA019



AT1PA1



AT1PA2



AT1PA4



AT1PA7

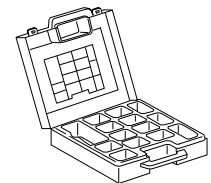

AT1HB2

[6] Orders must specify the standard package quantity (Std. Pack) or multiples of that quantity.
[7] Complete the catalog number by adding the number or letter desired.
Examples: AR1 MA015 is a card of 200 yellow markers with a black 5 marked on them.
R1 MB01T is a card of 200 yellow markers with a black T marked on them.

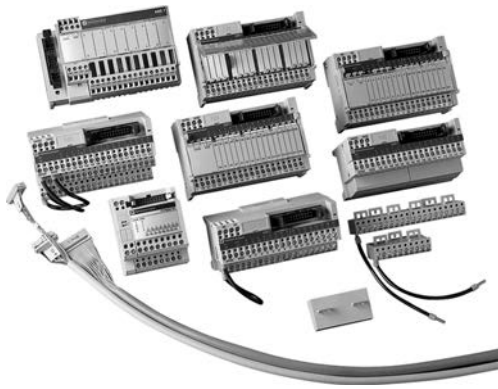

TELEFAST™ 2 Prewired Connection System

The TELEFAST 2 system is a set of products for the rapid connection of I/O modules (24 Vdc discrete, analog and counters) to Various control circuit components. These components act as a substitute for screw terminal blocks, remotely locating and partly eliminating the single wire connections. The system connects only to channels with HE10 and SUB-D connectors, or to standard terminal blocks with a cabled connector.

Variations within the listing of modules include those with and without relays (electromechanical and solid state), analog and counter modules, and special function modules.

Pre-wired cables available allow you to connect directly to:

- Schneider Electric (Modicon™ family)
 - Premium PAC
 - TSX Micro PLC
 - TSX Series 7
 - Twido PLC
 - Quantum PAC
 - Compact
 - April S5000/7000
 - NUM1020/1060-M340 PAC-M580 PAC-M221 PLC
- Siemens
 - S7 – 200/300/400
 - S5 – 95U to 155U
- Allen-Bradley
 - SLC500

In addition, other accessories include:

- I/O simulators
- Continuity blocks
- Label marking software
- Splitter bases (16, 23, and 32 channels)
- Mounting kits
- Detachable terminal strips
- Wiring pass-through connectors
- Fuses

Advantys Telefast 2 Product Features

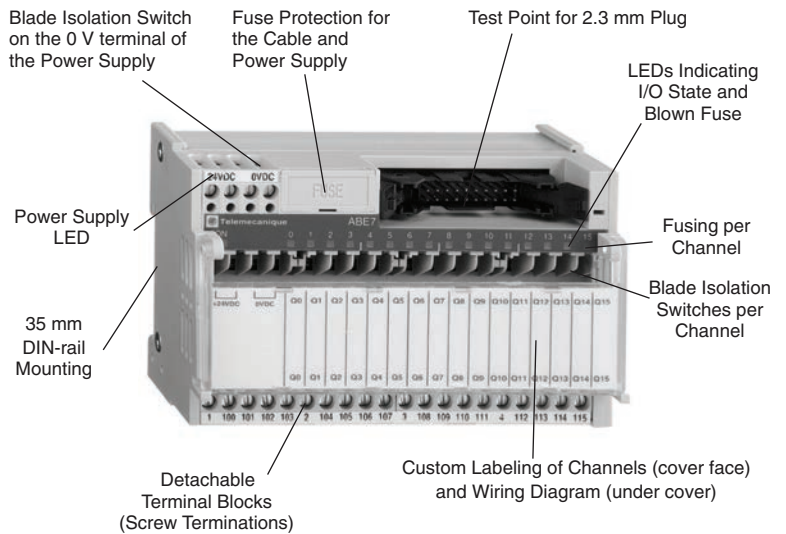

NOTE: Not all features are available on all modules.

