

Contents

Pages

3SE International (IEC) Limit Switches

3SE5 General data

Overview . . . . .13/4 - 13/9

3SE5 plastic enclosures

3SE5, selection and ordering data, 31 mm width. . . . .13/10 - 13/14

3SE5, selection and ordering data, 40 mm width. . . . .13/15 - 13/18

3SE5, selection and ordering data, 50 mm width. . . . .13/19 - 13/22

3SE5, selection and ordering data, ambient temperature to -40 C . . . . .13/23 - 13/26

3SE5 metal enclosures

3SE5, selection and ordering data, 31 mm width. . . . .13/27 - 13/30

3SE5, selection and ordering data, 40 mm width. . . . .13/31 - 13/34

3SE5, selection and ordering data, 56 mm width. . . . .13/35 - 13/38

3SE5, selection and ordering data, 56 mm width, XL. . . . .13/39 - 13/41

3SE5, selection and ordering data, ambient temperature to -40 C. . . . .13/42 - 13/44

3SE5 metal enclosures, compact design

3SE5, selection and ordering data. . . . .13/45 - 13/46

3SE5 open type design

3SE5, selection and ordering data. . . . .13/47

3SE5 accessories and spare parts

3SE5, selection and ordering data. . . . .13/48 - 13/50

3SE5 support information

Technical specifications. . . . .13/51

Configuration - actuation and operating travel . . . . .13/52 - 13/57

Dimensional drawings. . . . .13/58 - 13/60

Circuit diagrams. . . . .13/61

3SE03 North American (NEMA) Limit Switches

Plug-in and NEMA 6P Submersible

Overview . . . . .13/62

Technical specifications, modular plug-in and NEMA Type 6P submersible . . . . .13/63

Ordering and selection data:  
Modular, plug-in metal housing. . . . .13/64  
NEMA type 6P submersible, prewired cable . . . . .13/65  
NEMA type 6P submersible, prewired receptacle . . . . .13/66  
Modular, Plug-in and NEMA 6P submersible as components. . . . .13/67  
Levers for plug-in and NEMA type 6P submersible . . . . .13/68 - 13/69  
Wiring Diagrams . . . . .13/70  
Dimension Diagrams . . . . .13/71 - 13/73

Metal Enclosure

Ordering and selection data . . . . .13/74 - 13/75

Specifications . . . . .13/74 - 13/75

Technical Data. . . . .13/75

Dimension drawings . . . . .13/74 - 13/75



Plastic, 31 mm



Plastic, 50 mm



Metal, 40 mm



Metal, 56 mm



3SE5, Open-type



3SE5, Compact Design



3SE03, Modular Plug-in



3SE03, Metal Enclosure

### Contents

### Pages

#### 3SE Mechanical Safety

##### 3SE7 Cable-operated Switches

Overview, technical data and travel diagrams	13/76
Selection and ordering data	13/77 - 13/79
Dimension drawings	13/80

##### 3SE5 interlock switches with separate actuator

Overview	13/81
3SE5, selection and ordering data, plastic	13/82 - 13/83
3SE5, selection and ordering data, metal	13/84 - 13/85
3SE5, selection and ordering data, actuators	13/86
3SE2, selection and ordering data, plastic	13/87
Technical data	13/88
3SE5, operation and operating travel diagrams	13/89
3SE5, dimension drawings	13/90 - 13/91
3SE2, operation and operating travel diagrams	13/92
3SE2, dimension drawings	13/92

##### 3SE5 interlock switches with solenoid locking

General data	13/93 - 13/94
3SE5, selection and ordering data, plastic enclosures	13/95
3SE5, selection and ordering data, metal enclosures	13/96
3SE5, selection and ordering data, actuators	13/97
Technical data	13/98
3SE5, Schematics, operation and operating travel diagrams	13/99
3SE5, dimension drawings	13/100

##### 3SE5 / 3SE2 hinge switches

General data	13/101
3SE5, selection and ordering data, plastic	13/102
3SE5, selection and ordering data, metal	13/103
3SE2, selection and ordering data, plastic with integrated hinge	13/104
3SE5, contact blocks and operating travel diagrams	13/105
3SE5, dimension drawings	13/105
3SE2, technical data	13/106
3SE2, contact blocks and operating travel diagrams	13/106
3SE2, dimension drawings	13/106

##### 3SE6 RFID Non-Contact Safety Switches

General data and system overview	13/107 - 13/108
Technical data	13/109
Selection and ordering data	13/110

##### 3SE6 magnetic monitoring systems

General data	13/111
Selection and ordering data	13/112
Technical data	13/113
Dimension drawings	13/114
Circuit diagrams	13/115

##### 3SB3 Two-hand Control.

3SB3, selection and ordering data	13/116
-----------------------------------	--------



3SE7



Metal, 40 mm



Interlock, Metal, 54 mm



Hinge, Plastic, 31 mm



3SE6 RFID Switch



3SE6, Magnet System



3SB3 Two-Hand Control

### Contents

### Pages

#### Safety Relays

##### SIRIUS 3SK1 Safety Relays

General data and system overview . . . . .13/117 - 13/119  
Selection and ordering data . . . . .13/120 - 13/125  
Technical data . . . . .13/126  
Cross reference from 3TK28 . . . . .13/127 - 13/128

##### SIRIUS 3TK28 Safety Relays

General data and system overview . . . . .13/129 - 13/133  
Selection and ordering data . . . . .13/134 - 13/135  
Technical data . . . . .13/136 - 13/141  
Dimensional drawings . . . . .13/142

##### 3RK3 Modular Safety System

General data and system overview . . . . .13/143 - 13/146  
Selection and ordering data . . . . .13/147 - 13/150  
Technical data . . . . .13/151 - 13/152  
Application data . . . . .13/153  
Dimensional drawings . . . . .13/154



3SK1



3TK2845

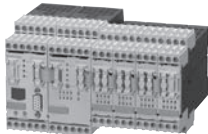

3RK3

## Introduction

### Overview



3SE5 23.,  
3SE5 21.,  
3SF1 2.4

3SE5 24.,  
3SF1 244

3SE5 13.,  
3SE5 11.,  
3SF1 114

3SE5 12.,  
3SF1 124

3SE5 16.

3SE5 232,  
3SE5 212,  
3SF1 2.4

3SE5 132,  
3SE5 112,  
3SF1 1.4

	Position switches, standard					Safety hinge switches	
<b>Enclosure</b>							
Plastic	✓	✓	✓	—	—	✓	✓
Metal	✓	—	✓	✓	✓	✓	✓
Dimensions (W x H x D) in mm	31 x 68 x 33	50 x 53 x 33	40 x 78 x 38	56 x 78 x 38	56 x 100 x 38	31 x 68 x 33	40 x 78 x 38
Degree of protection	IP65, IP66/IP67	IP66/IP67	IP66/IP67	IP66/IP67	IP66/IP67	IP65, IP66/IP67	IP66/IP67
<b>Standards</b>							
IEC 60947-5-1	Mounting and operating points acc. to EN 50047	Operating points acc. to EN 50047	Mounting and operating points acc. to EN 50041	Operating points acc. to EN 50041	Operating points acc. to EN 50047	Mounting and operating points acc. to EN 50047	Mounting and operating points acc. to EN 50041
<b>Approvals</b>	CE, UL, CSA, CCC			CE, UL, CSA, CCC		CE, UL, CSA, CCC	
<b>Contact blocks</b>							
2 slow-action contacts	1 NO + 1 NC, 2 NC		1 NO + 1 NC, 2 NC	—	—	1 NO + 1 NC	
2 snap-action contacts	1 NO + 1 NC		1 NO + 1 NC	—	—	1 NO + 1 NC	
• Short stroke	1 NO + 1 NC		✓	—	—	✓	
• With 2 x 2 mm contact gap	1 NO + 1 NC		✓	—	—	✓	
3 slow-action contacts	1 NO + 2 NC, 2 NO + 1 NC		1 NO + 2 NC, 2 NO + 1 NC	—	—	1 NO + 2 NC	
• With make-before-break	1 NO + 2 NC		1 NO + 2 NC	—	—	1 NO + 2 NC	
3 snap-action contacts	1 NO + 2 NC		1 NO + 2 NC	—	—	1 NO + 2 NC	
2 x (2 or 3 contacts)	—		—	—	✓	—	
<b>Special features</b>							
LED status display	✓		✓	—	—	✓	
Increased corrosion protection	✓		✓	—	✓	✓	
<b>Explosion protection (ATEX)</b>	—		✓	—	✓	✓	
<b>ASIsafe integrated</b>	✓		✓	—	—	✓	
<b>Electrical specifications</b>							
Insulation voltage $U_i$	400 V		400 V			400 V	
Conventional thermal current $I_{the}$	6 A/10 A (3-/2-pole)		6 A/10 A (3-/2-pole)			6 A/10 A (3-/2-pole)	
<b>Connections</b>							
Cable entry	1 x M20 x 1.5	2 x M20 x 1.5	1 x M20 x 1.5	3 x M20 x 1.5	1 x M20 x 1.5	1 x M20 x 1.5	1 x M20 x 1.5
M12 connector socket, 4-, 5- or 8-pole	✓	✓	✓	✓	✓	✓	✓
Connector socket, 6-pole + PE	—	—	✓	✓	—	—	—
<b>Actuators</b>							
Rounded plungers and roller plungers	✓		✓	—	—	—	
Roller and angular roller levers	✓		✓	—	—	—	
Spring rod	✓		✓	—	—	—	
Twist levers and rod actuators	✓		✓	—	—	—	
Fork lever	—		✓	—	—	—	
Hinge switches	—		—	—	—	✓	
<b>Page</b>							
Complete units	13/10, 13/27	13/19	13/15, 13/31	13/35	13/39	13/102	13/103
Modular system	13/13, 13/29	13/21	13/17, 13/33	13/37	13/40	—	—
Ambient temperature -40 °C	13/23, 13/42	13/23	13/26, 13/43	13/43	13/43	—	—
ASIsafe	on-line	on-line	on-line	on-line	—	on-line	on-line
ATEX	on-line	on-line	on-line	on-line	on-line	on-line	on-line

✓ Available  
— Not available

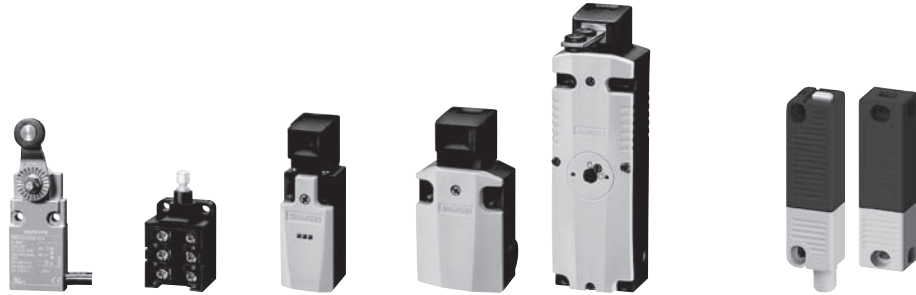

3SE5 413,  
3SE5 423

3SE5 250

3SE5 232,  
3SE5 242,  
3SF1 2.4

3SE5 112,  
3SE5 122,  
3SF1 1.4

3SE5 322,  
3SE5 312,  
3SF1 3.4

3SE63

	Compact design	Open-type	Safety switches with separate actuator		Safety switches with solenoid interlocking	RFID safety switch
<b>Enclosure</b>						
Plastic	—	✓	✓	✓	✓	✓
Metal	✓	—	✓	✓	✓	—
Dimensions (W x H x D) in mm	30 x .. x .., 40 x .. x ..	30 x 48.5 x 20	31 x 68 x 33, 50 x 53 x 33	40 x 78 x 38, 56 x 78 x 38	54 x 185 x 44	25 x 91 x 22
Degree of protection	IP66/IP67	IP10 or IP20	IP65, IP66/IP67	IP66/IP67	IP66/IP67	IP69K
<b>Standards</b>	—	Mounting and operating points acc. to EN 50047	Mounting acc. to EN 50047	Mounting acc. to EN 50041	EN 1088	Category 4 acc. to ISO 13849-1, PL e acc. to ISO 13849-1, SIL 3 acc. to IEC 61508
IEC 60947-5-1	—	—	—	—	—	—
<b>Approvals</b>	CE, UL, CSA	—	CE, TÜV, UL, CSA, CCC	CE, TÜV, UL, CSA, CCC	CE, TÜV, UL, CSA, CCC	CE, TÜV
<b>Contact blocks</b>						
2 slow-action contacts	—	1 NO + 1 NC	1 NO + 1 NC	—	—	—
2 snap-action contacts	1 NO + 1 NC	1 NO + 1 NC	—	—	—	—
• Short stroke	—	✓	—	—	—	—
• With 2 x 2 mm contact gap	—	✓	—	—	—	—
3 slow-action contacts	—	1 NO + 2 NC	1 NO + 2 NC	—	—	—
• With make-before-break	—	1 NO + 2 NC	—	—	—	—
3 snap-action contacts	—	1 NO + 2 NC	—	—	—	—
6 slow-action contacts	—	—	—	—	2 x (1 NO + 2 NC)	—
<b>Special features</b>						
LED status display	—	—	✓	—	✓	✓
Increased corrosion protection	—	—	✓	—	✓	✓
<b>Explosion protection (ATEX)</b>	—	—	✓	—	—	—
<b>ASIsafe integrated</b>	—	—	✓	—	✓	—
<b>Electrical specifications</b>						
Insulation voltage $U_i$	400 V	400 V	400 V	400 V	400 V	—
Conventional thermal current $I_{the}$	10 A	6 A	6 A	6 A	6 A	—
<b>Connections</b>						
Cable entry	—	—	1 x M20 x 1.5, 2 x M20 x 1.5	1 x M20 x 1.5, 3 x M20 x 1.5	3 x M20 x 1.5	—
M12 connector socket, 4-, 5- or 8-pole	✓	—	✓	✓	✓	✓
Molded cables	✓	—	—	—	—	—
AS-Interface	—	—	✓	✓	✓	—
<b>Actuators</b>						
Plungers, twist levers	✓	✓	—	—	—	—
Separate actuators	—	—	✓	—	✓	—
<b>Page</b>						
Complete units	13/46	13/47	13/82	13/85	13/95	—
Modular system	—	—	—	—	—	13/110
ASIsafe	—	—	on-line	on-line	on-line	—
ATEX	—	—	on-line	on-line	—	—

✓ Available  
— Not available

# Limit Switches

## SIRIUS 3SE5 International Limit Switches

### General Data

#### Overview

Position switches in the innovative SIRIUS 3SE5 series are modern in design, compact, modular and simple to connect.

#### Complete units

Popular versions of the position switches in standard enclosures are available as complete units.



Position switches with plastic and metal enclosures

#### Modular system

The 3SE5 series features a new modular system comprising different sizes of the basic switch and an actuator which must be ordered separately. Thanks to the modular construction of the switch the user can select the right solution for his application from numerous versions and install it himself in a very short time. The short delivery times of the modules enable fast replacement and thus ensure high plant availability.



Examples of selection options in the modular system

#### Design

##### Enclosure sizes

All enclosure versions have an integrated chlorinated rubber diaphragm for high functional safety in cold and aggressive environments.

The 3SE5 switches are available in five different enclosure sizes with 2 or 3 contacts and with the XL enclosure:

- Open-type position switch IP20 or IP10
- Plastic enclosures according to EN 50047 (31 mm wide), IP65, 1 cable entry
- Plastic enclosures (50 mm wide), IP66/IP67, 2 cable entries
- Metal enclosures according to EN 50047, (31 mm wide), IP66/IP67, 1 cable entry
- Plastic and metal enclosures according to EN 50041 (40 mm wide), IP66/IP67, 1 cable entry
- Metal enclosures (56 mm wide), IP66/IP67, 3 cable entries
- XL metal enclosures with 4 to 6 contacts, 56 mm wide, IP66/IP67, 3 cable entries

Various basic switches can be selected for the 3SE5 series:

- With contact blocks with two or three contacts (screw terminals) designed as slow-action or snap-action contacts; the slow-action contacts also make-before-break
- Optional LED status display
- With mounted four or five-pole M12 connector socket (available for the wide enclosures as an accessory for self-assembly)
- With 6-pole connector socket + PE on the metal enclosures
- With increased corrosion protection
- Versions for operating temperature to -40° C
- Metal enclosures for explosion protection (ATEX)
- AS-Interface version with integrated ASIsafe electronics for all enclosure designs

##### Actuator variants

All operating mechanisms can be rotate around the axis in increments of 22.5°. The following actuator variants are available:

- Standard, rounded and roller plungers
- Roller and angular roller levers
- Spring rods
- Twist levers and rod actuators
- Fork levers with twist actuator

The actuator rollers are available with various materials and diameters.

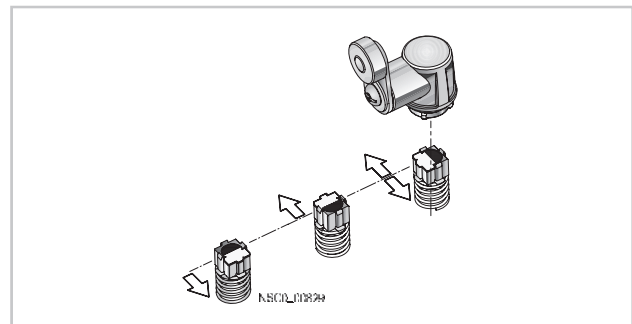

Twist actuators for twist levers and rod actuators, with setting of switching to right, left or right/left (standard for all twist actuators except version for fork levers)

### Optional LED indicators

LED indicators available for all enclosure sizes



The enclosure versions can be supplied with an LED signaling indicator (1 × green + 1 × yellow). This is the first time that optical signaling equipment is also available for small standard enclosures according to EN 50047. The LED signaling indicators are available in all common voltages (24 V DC and 230 V AC).

### Additional contacts

Exchangeable two and three-pole switching blocks for all enclosure sizes



The three-pole switching block (2 NC, 1 NO) in snap-action and slow-action is regularly available for all enclosure forms. It offers more switching through redundant shutdowns (2 NC contacts) with simultaneous signaling (1 NO contact). The same installation space is required as for a two-pole switching block.

### Contact reliability

The new contact blocks ensure an extremely high contact stability. This applies even when the devices are switching low voltages and currents, e. g. 1 mA at 5 V DC.

### Positive opening

The NC contacts of the switch are forced open mechanically, positively-driven and reliably by the plunger. This is referred to as "positive opening".

### Mounting

Easy plug-in method – for fast replacement of the actuator head

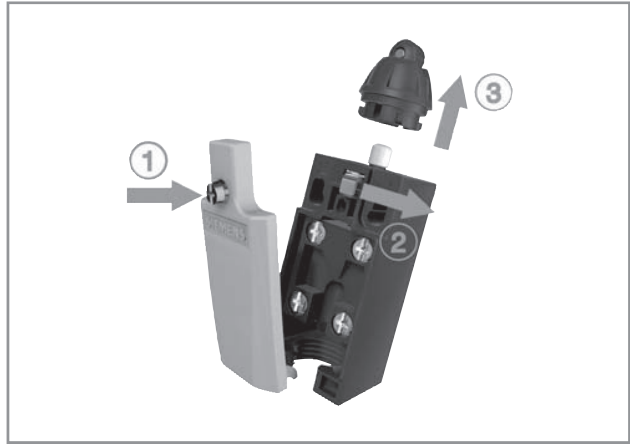

- (1) Open cover
- (2) Actuate locking lever
- (3) Replace the head (turnable by 16 x 22.5°)
- (4) Lock and close the cover

### Fast connection method

For plastic enclosure with a width of 31 mm

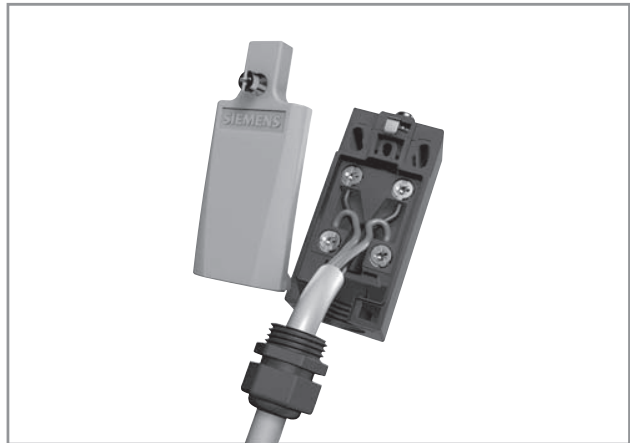

These position switches can be wired quickly and easily as an added customer benefit. The connecting cable is first connected to the terminals of the contact block and then guided through a slit into the cable gland opening. The time saved through this new connection method is approx. 20 to 25 %.

# Limit Switches

## SIRIUS 3SE5 International Limit Switches

### General Data

#### Benefits

The 3SE5 position switches differ from the previous series through the following new characteristics:

- The modular design of the product range allows a number of versions with a smaller number of bearing types for enclosures and operating mechanisms.
- All actuators can be turned around the axis in increments of 22.5° (see picture on page 13/6).
- Rounded and roller plungers according to EN 50041 with 3 mm overtravel (total travel 9 mm) for greater tolerance when switching
- All enclosure sizes – now also including the small enclosure 31 mm wide – are optionally available with an LED signaling indicator (see picture on page 13/7).
- All enclosure versions have an integrated chlorinated rubber diaphragm (high functional safety in cold and aggressive environments).
- All contact blocks are replaceable (see page 13/49).
- The three-pole contact blocks are available for all enclosure sizes (see picture on page 13/7).
- Elements with 1 NO + 2 NC slow-action contacts with make-before-break and 2 NO + 1 NC
- The short-stroke contact block 1 NO + 1 NC improves the precision of the switching operation through a reduced actuation path.
- The contact block with 1 NO + 1 NC snap-action contacts with 2 x 2 mm contact opening is suitable for simultaneous disconnection and signaling, particularly in the elevator industry
- NEW: XL enclosures for accommodating two 2- or 3-pole contact blocks
- The plastic enclosure with a width of 31 mm has simple and fast wiring equipment which makes it possible to save from approx. 20 to 25 % of the time when connecting (see picture on page 13/7).
- The ASIsafe electric component is integrated for the versions with the AS-Interface connection (see on-line); an additional adapter is not required.

#### Application

With the standard position switches, mechanical positions of moved machine parts are converted into electrical signals. Through their modular and uniform design and large number of versions, the devices can meet practically all requirements in industry.

Devices are available with enclosure versions to suit the particular ambient conditions. Different control tasks can be performed with the best contact blocks suited for the particular purpose. And many different actuator versions are available to match the mechanical configuration of the moved machined parts. Dimensions, fixing points and characteristics are largely in accordance with the EN 50041 or EN 50047 standards.

The devices are suitable for use in any climate.

#### Standards

IEC 60947-5-1 or EN 60947-5-1.

The protective measure of "total insulation" by the molded-plastic enclosure is guaranteed by the use of molded-plastic screw-lands.

#### Safety position switches

For controls according to IEC 60204-1 or EN 60204-1 the devices can be used as a safety position switch. To secure position switches against changes in their position, keyed techniques must be employed on installation.

#### Safety circuits

IEC 60947-5-1 and EN 60947-5-1 require positive opening of the NC contacts, i.e. for the purposes of personal safety, the assured opening of NC contacts is expressly stipulated for the electrical equipment of machines in all safety circuits and marked according to the IEC standard 60947-5-1 with the symbol  $q_1$ .

Category 2 according to ISO 13849-1 (EN 954-1) can be attained with 3SE5 position switches with  $q_1$ , and category 3 or 4 when using an additional position switch, if the corresponding failsafe evaluation units are selected and correctly installed, e.g. the 3TK28 safety relays or matching devices from the ASIsafe, SIMATIC or SINUMERIK product ranges. The operating mechanisms (actuators) must also be connected to the enclosure by keyed techniques. The corresponding operating mechanisms are marked in the catalog with  $q_1$ .

#### Contacts for each application

- Snap-action contacts: NC and NO contacts switch simultaneously – regardless of the actuating speed ( $v_{\min} = 0.01$  m/s) and contact erosion.
- Slow-action contacts: Difference in travel between "NC contact opens" and "NO contact closes"; the switching speed is the same as or proportional to the actuating speed ( $v_{\min} = 0.4$  m/s).
- Slow-action contacts with make-before-break: e.g. suitable for adding a second function to a sequence control.

#### Operating mechanisms for each application

##### Standard, rounded and roller plungers

- Operation in direction of the plunger axis or in case of roller plunger with bar at right angles to the plunger axis
- The roller plunger is recommended for lateral actuation and relatively long overtravel.

##### Roller and angular roller levers

- For actuators made of finely ground steel in the form of cams, straight-edges (approach angle 30°) or cam disks

##### Spring rod

- Can be used for undefined actuations and changing starting conditions
- Starting from any direction is possible

##### Twist levers and rod actuators

- For a high starting speed ( $v = 1.5$  m/s)
- Variety of starting options
- Insensitive to oil, grinding dust and coarse-grained material
- Adjustment of the lever in increments of 10°.
- Can be adjusted with left or right switching

##### Fork lever

- Switchable in two directions
- Latching actuator
- For reciprocating movements



# Limit Switches

## SIRIUS 3SE5 International Limit Switches

### General Data

1  
2  
3  
4  
5  
6  
7  
8  
9  
10  
11  
12  
13

### Options

On the following pages you will find selection tables for complete units as well as components of the modular system.

- Complete units
- Modular system

The difference between units is indicated in the selection and ordering data by gray backgrounds.

Using the modular system you can assemble switch variants which are not available as complete units. Each complete unit can also be supplied as a module.

A basic switch for the modular system comprises an enclosure with a contact block and a cover. Among the basic switches the following versions, for example, can be selected:

- Basic enclosure with teflon plunger
- Version with increased corrosion protection
- Version with 2 LEDs

- Version with M12 connector socket or 6-pole + PE
- Version with M12 connector socket and with 2 LEDs

For the plastic enclosures with a width of 31 and 50 mm the basic switches are designed as complete units with rounded plunger (according to standard).

### Online configurator

The online configurator helps you not only to select and order the right position switch but also to create complete product documentation.

- Product data sheets
- Dimensional drawings
- Operating travel diagrams
- CAD data in 2D and 3D model images
- Ordering data
- Product photos

[www.siemens.com/sirius/configurators](http://www.siemens.com/sirius/configurators)

### Complete units

#### Ordering example

Required:

- Position switch according to EN 50047 in a plastic enclosure
- Contact block with slow-action contacts 1 NO + 1 NC
- Angular roller lever, metal lever and plastic roller

To be ordered:

Version	Complete units <input type="checkbox"/>
Order No.	
<b>Complete units • Enclosure width 31 mm</b>	
 <p><b>Angular roller levers</b> With metal lever and plastic roller 13 mm Slow-action contacts 1 NO + 1 NC</p>	<b>3SE5 232-0BF10</b>

### Modular system

#### Ordering example 1

Required:



- Position switch according to EN 50047 in a plastic enclosure
- Contact block with slow-action contacts 1 NO + 1 NC
- Angular roller lever, metal lever and plastic roller

#### Ordering example 2



Required:

- Position switch according to EN 50047 in a plastic enclosure
- Contact block with slow-action contacts 1 NO + 1 NC
- Twist lever, high-grade steel lever and plastic roller

To be ordered separately:

Version	Modular system <input checked="" type="checkbox"/>
Order No.	
<b>Basic switches • Enclosure width 31 mm</b>	
 <p><b>With teflon plunger</b> Slow-action contacts 1 NO + 1 NC</p>	<b>3SE5 232-0BC05</b>
+	
<b>Operating mechanisms</b>	
 <p><b>Angular roller levers</b> Metal lever, plastic roller</p>	<b>3SE5 000-0AF10</b>

To be ordered separately:

Version	Modular system <input checked="" type="checkbox"/>
Order No.	
<b>Basic switches • Enclosure width 31 mm</b>	
 <p><b>With teflon plunger</b> Slow-action contacts 1 NO + 1 NC</p>	<b>3SE5 232-0BC05</b>
+	
<b>Twist actuators</b>	
 <p><b>Twist actuators</b></p>	<b>3SE5 000-0AK00</b>
 <p><b>Twist levers</b> High-grade steel lever, plastic roller</p>	<b>3SE5 000-0AA31</b>

# Limit Switches

## SIRIUS 3SE5 International Limit Switches

3SE5, plastic enclosures  
Enclosure width 31 mm acc. to EN 50047





### Selection and ordering data

#### Complete units

2 or 3 contacts · Degree of protection IP65 · Cable entry M20 × 1.5<sup>1)</sup>

Version	Contacts	LEDs	DT	Complete units	<input type="checkbox"/>	PU (UNIT, SET, M)	PS*
				<b>Configurator</b>			
				Order No.		Price per PU	

#### Complete units<sup>2)</sup> · Enclosure width 31 mm

<b>Rounded plungers, type B, acc. to EN 50047</b>							
	<b>With teflon plunger</b>						
	Slow-action contacts	1 NO + 1 NC	—	⊕	A	<b>3SE5 232-0BC05</b>	1 1 unit
	Snap-action contacts	1 NO + 1 NC	—	⊕	B	<b>3SE5 232-0CC05</b>	1 1 unit
	Snap-action contacts, integrated <sup>3)</sup>	1 NO + 1 NC	—	⊕	A	<b>3SE5 232-0HC05</b>	1 1 unit
	Snap-action contacts • Short stroke, integrated <sup>3)</sup>	1 NO + 1 NC	—	⊕	B	<b>3SE5 232-0FC05</b>	1 1 unit
	Snap-action contacts • 2 × 2 mm contact gap	1 NO + 1 NC	—	⊕	B	<b>3SE5 232-0GC05</b>	1 1 unit
	Slow-action contacts	1 NO + 2 NC	—	⊕	A	<b>3SE5 232-0KC05</b>	1 1 unit
	Snap-action contacts	1 NO + 2 NC	—	⊕	A	<b>3SE5 232-0LC05</b>	1 1 unit
	Slow-action contacts with make- before-break	1 NO + 2 NC	—	⊕	▶	<b>3SE5 232-0MC05</b>	1 1 unit
	Slow-action contacts	2 NO + 1 NC	—	⊕	A	<b>3SE5 232-0PC05</b>	1 1 unit
	<b>With increased corrosion protection</b>						
	Slow-action contacts	1 NO + 1 NC	—	⊕	B	<b>3SE5 232-0BC05-1CA0</b>	1 1 unit
	Snap-action contacts	1 NO + 1 NC	—	⊕	B	<b>3SE5 232-0CC05-1CA0</b>	1 1 unit
	Slow-action contacts	1 NO + 2 NC	—	⊕	B	<b>3SE5 232-0KC05-1CA0</b>	1 1 unit
	Snap-action contacts	1 NO + 2 NC	—	⊕	B	<b>3SE5 232-0LC05-1CA0</b>	1 1 unit
	Slow-action contacts with make- before-break	1 NO + 2 NC	—	⊕	B	<b>3SE5 232-0MC05-1CA0</b>	1 1 unit
	Slow-action contacts	2 NO + 1 NC	—	⊕	B	<b>3SE5 232-0PC05-1CA0</b>	1 1 unit
	<b>With M12 connector socket, 4-pole (250 V, 4 A)</b>						
	Slow-action contacts	1 NO + 1 NC	—	⊕	B	<b>3SE5 234-0BC05-1AC4</b>	1 1 unit
	Snap-action contacts, integrated <sup>3)</sup>	1 NO + 1 NC	—	⊕	A	<b>3SE5 234-0HC05-1AC4</b>	1 1 unit
	Slow-action contacts	2 NC	—	⊕	B	<b>3SE5 234-0KC05-1AE0</b>	1 1 unit
	Snap-action contacts	2 NC	—	⊕	A	<b>3SE5 234-0LC05-1AE0</b>	1 1 unit
	<b>With 2 LEDs, yellow/green</b>						
	Slow-action contacts	1 NO + 2 NC	24 V DC	⊕	B	<b>3SE5 232-1KC05</b>	1 1 unit
	Snap-action contacts	1 NO + 2 NC	24 V DC	⊕	B	<b>3SE5 232-1LC05</b>	1 1 unit
	Slow-action contacts	1 NO + 2 NC	230 V AC	⊕	B	<b>3SE5 232-3KC05</b>	1 1 unit
	Snap-action contacts	1 NO + 2 NC	230 V AC	⊕	B	<b>3SE5 232-3LC05</b>	1 1 unit
	<b>With M12 connector socket, 5-pole (125 V, 4 A) and 2 LEDs</b>						
	Slow-action contacts	1 NO + 1 NC	24 V DC	⊕	B	<b>3SE5 234-1BC05-1AF3</b>	1 1 unit
	Snap-action contacts	1 NO + 1 NC	24 V DC	⊕	B	<b>3SE5 234-1CC05-1AF3</b>	1 1 unit

For online configurator see [www.siemens.com/sirius/configurators](http://www.siemens.com/sirius/configurators).

Positive opening according to IEC 60947-5-1, Appendix K.

<sup>1)</sup> A cable gland with seal must be used with the quick-connect method.

<sup>2)</sup> Popular versions.

<sup>3)</sup> Subsequent replacement of contact blocks is not possible.

# Limit Switches





## SIRIUS 3SE5 International Limit Switches

3SE5, plastic enclosures  
Enclosure width 31 mm acc. to EN 50047

2 or 3 contacts · Degree of protection IP65 · Cable entry M20 × 1.5<sup>1)</sup>

Version	Contacts	LEDs	DT	Complete units	<input type="checkbox"/>	PU (UNIT, SET, M)	PS*
				<b>Configurator</b>			
				Order No.		Price per PU	

### Complete units<sup>2)</sup> · Enclosure width 31 mm

	<b>Roller plungers, type C acc. to EN 50047</b>						
	<b>With plastic roller 10 mm</b>						
	Slow-action contacts	1 NO + 1 NC	—	⊕ B	<b>3SE5 232-0BD03</b>	1	1 unit
	Snap-action contacts • Integrated <sup>3)</sup>	1 NO + 1 NC	—	⊕ A	<b>3SE5 232-0HD03</b>	1	1 unit
	Snap-action contacts • Short stroke, integrated <sup>3)</sup>	1 NO + 1 NC	—	⊕ B	<b>3SE5 232-0FD03</b>	1	1 unit
	Slow-action contacts	1 NO + 2 NC	—	⊕ B	<b>3SE5 232-0KD03</b>	1	1 unit
	Snap-action contacts	1 NO + 2 NC	—	⊕ ▶	<b>3SE5 232-0LD03</b>	1	1 unit
	<b>Actuator head rotated by 90°</b>						
	Snap-action contacts	1 NO + 2 NC	—	⊕ B	<b>3SE5 232-0LD03-1AH0</b>	1	1 unit
	<b>With M12 connector socket, 4-pole (250 V, 4 A)</b>						
	Snap-action contacts, integrated <sup>3)</sup>	1 NO + 1 NC	—	⊕ B	<b>3SE5 234-0HD03-1AC4</b>	1	1 unit
	<b>Roller plungers with central fixing</b>						
	Snap-action contacts, integrated <sup>3)</sup>	1 NO + 1 NC	—	⊕ B	<b>3SE5 232-0HD10</b>	1	1 unit
	Slow-action contacts	1 NO + 2 NC	—	⊕ B	<b>3SE5 232-0KD10</b>	1	1 unit
	<b>Roller levers, type E acc. to EN 50047</b>						
	<b>With metal lever and plastic roller 13 mm</b>						
	Slow-action contacts	1 NO + 1 NC	—	⊕ ▶	<b>3SE5 232-0BE10</b>	1	1 unit
	Snap-action contacts, integrated <sup>3)</sup>	1 NO + 1 NC	—	⊕ A	<b>3SE5 232-0HE10</b>	1	1 unit
	Slow-action contacts	1 NO + 2 NC	—	⊕ B	<b>3SE5 232-0KE10</b>	1	1 unit
	Snap-action contacts	1 NO + 2 NC	—	⊕ B	<b>3SE5 232-0LE10</b>	1	1 unit
	<b>With M12 connector socket, 4-pole (250 V, 4 A)</b>						
	Snap-action contacts, integrated <sup>3)</sup>	1 NO + 1 NC	—	⊕ B	<b>3SE5 234-0HE10-1AC4</b>	1	1 unit
	<b>Angular roller levers</b>						
	<b>With metal lever and plastic roller 13 mm</b>						
	Slow-action contacts	1 NO + 1 NC	—	⊕ ▶	<b>3SE5 232-0BF10</b>	1	1 unit
	Snap-action contacts, integrated <sup>3)</sup>	1 NO + 1 NC	—	⊕ ▶	<b>3SE5 232-0HF10</b>	1	1 unit
	Slow-action contacts	1 NO + 2 NC	—	⊕ B	<b>3SE5 232-0KF10</b>	1	1 unit
	Snap-action contacts	1 NO + 2 NC	—	⊕ B	<b>3SE5 232-0LF10</b>	1	1 unit

For online configurator see [www.siemens.com/sirius/configurators](http://www.siemens.com/sirius/configurators).

⊕ Positive opening according to IEC 60947-5-1, Appendix K.

<sup>1)</sup> A cable gland with seal must be used with the quick-connect method.

<sup>2)</sup> Popular versions.

<sup>3)</sup> Subsequent replacement of contact blocks is not possible.

# Limit Switches

## SIRIUS 3SE5 International Limit Switches

**3SE5, plastic enclosures**  
**Enclosure width 31 mm acc. to EN 50047**

2 or 3 contacts · Degree of protection IP65 · Cable entry M20 × 1.5<sup>1)</sup>

Version	Contacts	LEDs	DT	Complete units	<input type="checkbox"/>	PU (UNIT, SET, M)	PS*
				<b>Configurator</b>			
				Order No.	Price per PU		

### Complete units<sup>2)</sup> · Enclosure width 31 mm



Spring rod



Twist lever



Twist lever, adjustable length



Rod actuator

#### Spring rods

**Length 142.5 mm, with plastic plunger 50 mm**

Snap-action contacts, integrated<sup>3)</sup> 1 NO + 1 NC —

**With M12 connector socket, 4-pole (250 V, 4 A)**

Snap-action contacts, integrated<sup>3)</sup> 1 NO + 1 NC —

#### Twist levers, type A acc. to EN 50047

**With metal lever 21 mm and plastic roller 19 mm**

Slow-action contacts 1 NO + 1 NC —

Snap-action contacts, integrated<sup>3)</sup> 1 NO + 1 NC —

Slow-action contacts 1 NO + 2 NC —

Snap-action contacts 1 NO + 2 NC —

**With M12 connector socket, 4-pole (250 V, 4 A)**

Snap-action contacts, integrated<sup>3)</sup> 1 NO + 1 NC —

**With metal lever 35 mm and plastic roller 19 mm**

Snap-action contacts, integrated<sup>3)</sup> 1 NO + 1 NC —

#### Twist levers, adjustable length

**With metal lever with grid hole and plastic roller 19 mm**

Snap-action contacts, integrated<sup>3)</sup> 1 NO + 1 NC —

**With metal lever and plastic roller 19 mm**

Slow-action contacts 1 NO + 1 NC —

Snap-action contacts, integrated<sup>3)</sup> 1 NO + 1 NC —

Snap-action contacts 1 NO + 2 NC —

**With M12 connector socket, 4-pole (250 V, 4 A)**

Snap-action contacts, integrated<sup>3)</sup> 1 NO + 1 NC —

#### Rod actuators

**With aluminum rod, length 200 mm**

Snap-action contacts, integrated<sup>3)</sup> 1 NO + 1 NC —

**With plastic rod, length 200 mm**

Snap-action contacts, integrated<sup>3)</sup> 1 NO + 1 NC —

**With M12 connector socket, 4-pole (250 V, 4 A)**

Snap-action contacts, integrated<sup>3)</sup> 1 NO + 1 NC —

A	3SE5 232-0HR01	1	1 unit
B	3SE5 234-0HR01-1AC4	1	1 unit
⊕ ▶	3SE5 232-0BK21	1	1 unit
⊕ ▶	3SE5 232-0HK21	1	1 unit
⊕ B	3SE5 232-0KK21	1	1 unit
⊕ B	3SE5 232-0LK21	1	1 unit
⊕ B	3SE5 234-0HK21-1AC4	1	1 unit
⊕ B	3SE5 232-0HK15	1	1 unit
⊕ A	3SE5 232-0HK60	1	1 unit
B	3SE5 232-0BK50	1	1 unit
▶	3SE5 232-0HK50	1	1 unit
B	3SE5 232-0LK50	1	1 unit
B	3SE5 234-0HK50-1AC4	1	1 unit
B	3SE5 232-0HK80	1	1 unit
▶	3SE5 232-0HK82	1	1 unit
B	3SE5 234-0HK82-1AC4	1	1 unit

For online configurator see [www.siemens.com/sirius/configurators](http://www.siemens.com/sirius/configurators).

Positive opening according to IEC 60947-5-1, Appendix K.

<sup>1)</sup> A cable gland with seal must be used with the quick-connect method.

<sup>2)</sup> Popular versions.

<sup>3)</sup> Subsequent replacement of contact blocks is not possible.

Note:

If the device you require is not available as a complete unit, see "Modular System", page 13/13.

# Limit Switches

## SIRIUS 3SE5 International Limit Switches

3SE5, plastic enclosures  
Enclosure width 31 mm acc. to EN 50047





1  
2  
3  
4  
5  
6  
7  
8  
9  
10  
11  
12  
13

### Modular system

2 or 3 contacts · Degree of protection IP65 · Cable entry M20 × 1.5<sup>1)</sup>

Version	Contacts	LEDs	DT	Modular system		PU (UNIT, SET, M)	PS*
				<b>Configurator</b>			
				Order No.	Price per PU		

### Basic switches · Enclosure width 31 mm (with rounded plunger<sup>2)</sup>)

 Basic switch	<b>With teflon plunger</b>						
	Slow-action contacts	1 NO + 1 NC	—	⊕ A	<b>3SE5 232-0BC05</b>	1	1 unit
	Snap-action contacts	1 NO + 1 NC	—	⊕ ▶	<b>3SE5 232-0CC05</b>	1	1 unit
	Snap-action contacts, integrated <sup>3)</sup>	1 NO + 1 NC	—	⊕ ▶	<b>3SE5 232-0HC05</b>	1	1 unit
	Snap-action contacts • Short stroke, integrated <sup>3)</sup>	1 NO + 1 NC	—	⊕ B	<b>3SE5 232-0FC05</b>	1	1 unit
	Snap-action contacts • 2 × 2 mm contact gap	1 NO + 1 NC	—	⊕ B	<b>3SE5 232-0GC05</b>	1	1 unit
	Slow-action contacts	1 NO + 2 NC	—	⊕ A	<b>3SE5 232-0KC05</b>	1	1 unit
	Snap-action contacts	1 NO + 2 NC	—	⊕ ▶	<b>3SE5 232-0LC05</b>	1	1 unit
	Slow-action contacts with make-before-break	1 NO + 2 NC	—	⊕ A	<b>3SE5 232-0MC05</b>	1	1 unit
Slow-action contacts	2 NO + 1 NC	—	⊕ A	<b>3SE5 232-0PC05</b>	1	1 unit	
 With increased corrosion protection	<b>With increased corrosion protection<sup>4)</sup></b>						
	Slow-action contacts	1 NO + 1 NC	—	⊕ B	<b>3SE5 232-0BC05-1CA0</b>	1	1 unit
	Snap-action contacts	1 NO + 1 NC	—	⊕ B	<b>3SE5 232-0CC05-1CA0</b>	1	1 unit
	Slow-action contacts	1 NO + 2 NC	—	⊕ B	<b>3SE5 232-0KC05-1CA0</b>	1	1 unit
	Snap-action contacts	1 NO + 2 NC	—	⊕ B	<b>3SE5 232-0LC05-1CA0</b>	1	1 unit
	Slow-action contacts with make-before-break	1 NO + 2 NC	—	⊕ B	<b>3SE5 232-0MC05-1CA0</b>	1	1 unit
Slow-action contacts	2 NO + 1 NC	—	⊕ B	<b>3SE5 232-0PC05-1CA0</b>	1	1 unit	
 With M12 socket	<b>With M12 connector socket, 4-pole (250 V, 4 A)</b>						
	Slow-action contacts	1 NO + 1 NC	—	⊕ B	<b>3SE5 234-0BC05-1AC4</b>	1	1 unit
	Snap-action contacts, integrated <sup>3)</sup>	1 NO + 1 NC	—	⊕ A	<b>3SE5 234-0HC05-1AC4</b>	1	1 unit
	Slow-action contacts	2 NC	—	⊕ B	<b>3SE5 234-0KC05-1AE0</b>	1	1 unit
Snap-action contacts	2 NC	—	⊕ A	<b>3SE5 234-0LC05-1AE0</b>	1	1 unit	
 With 2 LEDs	<b>With 2 LEDs, yellow/green</b>						
	Slow-action contacts	1 NO + 2 NC	24 V DC	⊕ B	<b>3SE5 232-1KC05</b>	1	1 unit
	Snap-action contacts	1 NO + 2 NC	24 V DC	⊕ B	<b>3SE5 232-1LC05</b>	1	1 unit
	Slow-action contacts	1 NO + 2 NC	230 V AC	⊕ B	<b>3SE5 232-3KC05</b>	1	1 unit
Snap-action contacts	1 NO + 2 NC	230 V AC	⊕ B	<b>3SE5 232-3LC05</b>	1	1 unit	
 With M12 socket and 2 LEDs	<b>With M12 connector socket, 5-pole (125 V, 4 A) and 2 LEDs</b>						
	Slow-action contacts	1 NO + 1 NC	24 V DC	⊕ B	<b>3SE5 234-1BC05-1AF3</b>	1	1 unit
Snap-action contacts	1 NO + 1 NC	24 V DC	⊕ B	<b>3SE5 234-1CC05-1AF3</b>	1	1 unit	

For online configurator see [www.siemens.com/sirius/configurators](http://www.siemens.com/sirius/configurators) .

⊕ Positive opening according to IEC 60947-5-1, Appendix K, or positively driven actuator, necessary in safety circuits.

<sup>1)</sup> A cable gland with seal must be used with the quick-connect method.

<sup>2)</sup> For enclosures with widths of 31mm, the basic switch is a complete unit with rounded plungers.

<sup>3)</sup> Subsequent replacement of contact blocks is not possible.

<sup>4)</sup> Use corresponding high-grade steel lever.











Note:

Selection aid [see page 13/9](#).

# Limit Switches

## SIRIUS 3SE5 International Limit Switches

3SE5, plastic enclosures  
Enclosure width 31 mm acc. to EN 50047

Version	Diameter	DT	Modular system	Price per PU	PU (UNIT, SET, M)	PS*
	mm		Order No.			
<b>Operating mechanisms</b>						
 Roller plunger	<b>Roller plungers, type C acc. to EN 50047</b>					
	Plastic rollers	10	➔ ▶	<b>3SE5 000-0AD03</b>	1	1 unit
	High-grade steel rollers	10	➔ B	<b>3SE5 000-0AD04</b>	1	1 unit
 With central fixing	<b>Roller plungers with central fixing</b>					
	Plastic rollers	10	➔ B	<b>3SE5 000-0AD10</b>	1	1 unit
	High-grade steel rollers	10	➔ B	<b>3SE5 000-0AD11</b>	1	1 unit
 Roller lever	<b>Roller levers, type E acc. to EN 50047</b>					
	Metal lever, plastic roller	13	➔ ▶	<b>3SE5 000-0AE10</b>	1	1 unit
	Metal lever, high-grade steel roller	13	➔ ▶	<b>3SE5 000-0AE11</b>	1	1 unit
	High-grade steel lever, plastic roller	13	➔ B	<b>3SE5 000-0AE12</b>	1	1 unit
	High-grade steel lever, high-grade steel roller	13	➔ B	<b>3SE5 000-0AE13</b>	1	1 unit
 Angular roller lever	<b>Angular roller levers</b>					
	Metal lever, plastic roller	13	➔ ▶	<b>3SE5 000-0AF10</b>	1	1 unit
	Metal lever, high-grade steel roller	13	➔ B	<b>3SE5 000-0AF11</b>	1	1 unit
	High-grade steel lever, plastic roller	13	➔ A	<b>3SE5 000-0AF12</b>	1	1 unit
	High-grade steel lever, high-grade steel roller	13	➔ B	<b>3SE5 000-0AF13</b>	1	1 unit
 Spring rod	<b>Spring rods</b> (for switches with snap-action contacts only)					
	Plastic plunger and high-grade steel spring:					
		• Length 142.5 mm (spring 50 mm, plunger 50 mm)	▶	<b>3SE5 000-0AR01</b>	1	1 unit
		• Length 76 mm (spring 23.5 mm, plunger 10 mm)	▶	<b>3SE5 000-0AR03</b>	1	1 unit
		• Length 242.5 mm (spring 150 mm, plunger 50 mm)	B	<b>3SE5 000-0AR04</b>	1	1 unit
		High-grade steel plunger and spring:				
	• Length 142.5 mm (spring 50 mm, plunger 50 mm)	B	<b>3SE5 000-0AR02</b>	1	1 unit	
<b>Twist actuators</b>						
 Twist actuator	<b>Twist actuators, plastic (without lever)</b>					
	Switching right and/or left, adjustable		➔ ▶	<b>3SE5 000-0AK00</b>	1	1 unit
<b>Levers for twist actuators</b>						
 Twist lever	<b>Twist levers 21 mm, straight, type A acc. to EN 50047</b>					
	Metal lever, plastic roller	19	➔ ▶	<b>3SE5 000-0AA21</b>	1	1 unit
	Metal lever, high-grade steel roller	19	➔ B	<b>3SE5 000-0AA22</b>	1	1 unit
	Metal lever, roller with ball bearing	19	➔ B	<b>3SE5 000-0AA23</b>	1	1 unit
	Metal lever, plastic roller	30	➔ B	<b>3SE5 000-0AA25</b>	1	1 unit
	High-grade steel lever, plastic roller	19	➔ B	<b>3SE5 000-0AA31</b>	1	1 unit
	High-grade steel lever, high-grade steel roller	19	➔ B	<b>3SE5 000-0AA32</b>	1	1 unit
 Twist lever, adjustable length	<b>Twist levers 30 mm, straight<sup>1)</sup></b>					
	Metal lever, plastic roller	19	➔ B	<b>3SE5 000-0AA24</b>	1	1 unit
 Twist lever, adjustable length	<b>Twist levers, adjustable length, with grid hole</b>					
	Metal lever, plastic roller	19	➔ ▶	<b>3SE5 000-0AA60</b>	1	1 unit
	Metal lever, high-grade steel roller	19	➔ ▶	<b>3SE5 000-0AA61</b>	1	1 unit
	Metal lever, plastic roller	50	➔ B	<b>3SE5 000-0AA67</b>	1	1 unit
	Metal lever, rubber roller	50	➔ B	<b>3SE5 000-0AA68</b>	1	1 unit
	High-grade steel lever, plastic roller	19	➔ B	<b>3SE5 000-0AA62</b>	1	1 unit
	High-grade steel lever, high-grade steel roller	19	➔ B	<b>3SE5 000-0AA63</b>	1	1 unit
 Rod actuator	<b>Twist levers, adjustable length</b>					
	Metal lever, plastic roller	19	A	<b>3SE5 000-0AA50</b>	1	1 unit
	Metal lever, high-grade steel roller	19	B	<b>3SE5 000-0AA51</b>	1	1 unit
	Metal lever, plastic roller	30	B	<b>3SE5 000-0AA55</b>	1	1 unit
	Metal lever, plastic roller	50	B	<b>3SE5 000-0AA57</b>	1	1 unit
	Metal lever, rubber roller	50	B	<b>3SE5 000-0AA58</b>	1	1 unit
	High-grade steel lever, plastic roller	19	B	<b>3SE5 000-0AA52</b>	1	1 unit
	High-grade steel lever, high-grade steel roller	19	B	<b>3SE5 000-0AA53</b>	1	1 unit
<b>Rod actuators</b>						
Aluminum rod, length 200 mm	6	▶	<b>3SE5 000-0AA80</b>	1	1 unit	
Spring rod, length 200 mm	6	B	<b>3SE5 000-0AA81</b>	1	1 unit	
Plastic rod, length 200 mm	6	▶	<b>3SE5 000-0AA82</b>	1	1 unit	

➔ Positively driven actuator, necessary in safety circuits.

<sup>1)</sup> Can be clinch mounted (turned through 180°, rear of lever).

# Limit Switches

## SIRIUS 3SE5 International Limit Switches

3SE5, plastic enclosures  
Enclosure width 40 mm acc. to EN 50041

### Selection and ordering data

#### Complete units

2 or 3 contacts · Degree of protection IP66/67 · Cable entry M20 x 1.5

Version	Contacts	LEDs	DT	Complete units	<input type="checkbox"/>	PU (UNIT, SET, M)	PS*
				<b>Configurator</b>			
				Order No.		Price per PU	

#### Complete units<sup>1)</sup> · Enclosure width 40 mm

	<b>Plain plungers</b>						
	<b>With high-grade steel plunger</b>						
	Slow-action contacts	1 NO + 1 NC	—	⊕ B	3SE5 132-0BB01	1	1 unit
	Snap-action contacts	1 NO + 1 NC	—	⊕ B	3SE5 132-0CB01	1	1 unit
	Slow-action contacts	1 NO + 2 NC	—	⊕ B	3SE5 132-0KB01	1	1 unit
	Snap-action contacts	1 NO + 2 NC	—	⊕ B	3SE5 132-0LB01	1	1 unit
	Slow-action contacts	2 NO + 1 NC	—	⊕ B	3SE5 132-0PB01	1	1 unit
	<b>Rounded plungers, type B acc. to EN 50041</b>						
	<b>With plastic plunger</b>						
	Slow-action contacts	1 NO + 1 NC	—	⊕ A	3SE5 132-0BC03	1	1 unit
	Snap-action contacts	1 NO + 1 NC	—	⊕ A	3SE5 132-0CC03	1	1 unit
	Slow-action contacts	1 NO + 2 NC	—	⊕ B	3SE5 132-0KC03	1	1 unit
	Snap-action contacts	1 NO + 2 NC	—	⊕ B	3SE5 132-0LC03	1	1 unit
	Slow-action contacts	2 NO + 1 NC	—	⊕ B	3SE5 132-0PC03	1	1 unit
	<b>Roller plungers, type C acc. to EN 50041</b>						
	<b>With plastic roller 13 mm</b>						
	Slow-action contacts	1 NO + 1 NC	—	⊕ B	3SE5 132-0BD05	1	1 unit
	Snap-action contacts	1 NO + 1 NC	—	⊕ A	3SE5 132-0CD05	1	1 unit
	Slow-action contacts	1 NO + 2 NC	—	⊕ B	3SE5 132-0KD05	1	1 unit
	Snap-action contacts	1 NO + 2 NC	—	⊕ B	3SE5 132-0LD05	1	1 unit
	Slow-action contacts	2 NO + 1 NC	—	⊕ B	3SE5 132-0PD05	1	1 unit
	<b>Roller levers</b>						
	<b>With metal lever and plastic roller 22 mm</b>						
	Slow-action contacts	1 NO + 1 NC	—	⊕ B	3SE5 132-0BE05	1	1 unit
	Snap-action contacts	1 NO + 1 NC	—	⊕ A	3SE5 132-0CE05	1	1 unit
	Slow-action contacts	1 NO + 2 NC	—	⊕ B	3SE5 132-0KE05	1	1 unit
	Snap-action contacts	1 NO + 2 NC	—	⊕ B	3SE5 132-0LE05	1	1 unit
	Slow-action contacts	2 NO + 1 NC	—	⊕ B	3SE5 132-0PE05	1	1 unit
	<b>Angular roller levers</b>						
	<b>With metal lever and plastic roller 22 mm</b>						
	Slow-action contacts	1 NO + 1 NC	—	⊕ B	3SE5 132-0BF05	1	1 unit
	Snap-action contacts	1 NO + 1 NC	—	⊕ B	3SE5 132-0CF05	1	1 unit
	Snap-action contacts	1 NO + 2 NC	—	⊕ B	3SE5 132-0LF05	1	1 unit
	<b>Spring rods</b>						
	<b>Length 142.5 mm, with plastic plunger 50 mm</b>						
	Snap-action contacts	1 NO + 1 NC	—	B	3SE5 132-0CR01	1	1 unit
	Snap-action contacts	1 NO + 2 NC	—	B	3SE5 132-0LR01	1	1 unit

For online configurator see [www.siemens.com/sirius/configurators](http://www.siemens.com/sirius/configurators).

⊕ Positive opening according to IEC 60947-5-1, Appendix K.

<sup>1)</sup> Popular versions.

# Limit Switches

## SIRIUS 3SE5 International Limit Switches

**3SE5, plastic enclosures**  
**Enclosure width 40 mm acc. to EN 50041**

2 or 3 contacts · Degree of protection IP66/IP67 · Cable entry M20 × 1.5

Version	Contacts	LEDs	DT	Complete units	<input type="checkbox"/>	PU (UNIT, SET, M)	PS*
				<b>Configurator</b>			
				Order No.		Price per PU	

### Complete units<sup>1)</sup> · Enclosure width 40 mm



Twist lever

#### Twist levers, type A acc. to EN 50041

##### With metal lever 27 mm and plastic roller 19 mm

Slow-action contacts	1 NO + 1 NC	—		A	<b>3SE5 132-0BJ01</b>	1	1 unit
Snap-action contacts	1 NO + 1 NC	—		▶	<b>3SE5 132-0CJ01</b>	1	1 unit
Slow-action contacts	1 NO + 2 NC	—		B	<b>3SE5 132-0KJ01</b>	1	1 unit
Snap-action contacts	1 NO + 2 NC	—		B	<b>3SE5 132-0LJ01</b>	1	1 unit
Slow-action contacts	2 NO + 1 NC	—		B	<b>3SE5 132-0PJ01</b>	1	1 unit



Twist lever, adjustable length, with grid hole

#### Twist levers, adjustable length

##### With metal lever with grid hole and plastic roller 19 mm

Snap-action contacts	1 NO + 1 NC	—		B	<b>3SE5 132-0CJ60</b>	1	1 unit
Snap-action contacts	1 NO + 2 NC	—		B	<b>3SE5 132-0LJ60</b>	1	1 unit



Twist lever, adjustable length

##### With metal lever and plastic roller 19 mm

Snap-action contacts	1 NO + 1 NC	—		A	<b>3SE5 132-0CJ50</b>	1	1 unit
Snap-action contacts	1 NO + 2 NC	—		B	<b>3SE5 132-0LJ50</b>	1	1 unit



Rod actuator

#### Rod actuators, type D, acc. to EN 50041

##### With aluminum rod, length 200 mm

Snap-action contacts	1 NO + 1 NC	—		B	<b>3SE5 132-0CJ80</b>	1	1 unit
----------------------	-------------	---	--	---	-----------------------	---	--------

##### With plastic rod, length 200 mm

Snap-action contacts	1 NO + 1 NC	—		A	<b>3SE5 132-0CJ82</b>	1	1 unit
----------------------	-------------	---	--	---	-----------------------	---	--------

For online configurator see [www.siemens.com/sirius/configurators](http://www.siemens.com/sirius/configurators).

Positive opening according to IEC 60947-5-1, Appendix K.

<sup>1)</sup> Popular versions.

#### Note:

If the device you require is not available as a complete unit, see "Modular System", page 13/17.





# Limit Switches

## SIRIUS 3SE5 International Limit Switches





3SE5, plastic enclosures  
Enclosure width 40 mm acc. to EN 50041

### Modular system

2 or 3 contacts · Degree of protection IP66/IP67 · Cable entry M20 × 1.5

Version	Contacts	LEDs	DT	Modular system	PU (UNIT, SET, M)	PS*
						
						
				Order No.	Price per PU	

### Basic switches · Enclosure width 40 mm

Image	Description	Contacts	LEDs	DT	DT	Part No.	PU	PS*
	<b>With M20 × 1.5 connecting thread</b>							
	Slow-action contacts	1 NO + 1 NC	—	⊕	B	<b>3SE5 132-0BA00</b>	1	1 unit
	Snap-action contacts	1 NO + 1 NC	—	⊕	A	<b>3SE5 132-0CA00</b>	1	1 unit
	• Gold-plated contacts			⊕	B	<b>3SE5 132-0CA00-1AC1</b>	1	1 unit
	Slow-action contacts	1 NO + 2 NC	—	⊕	B	<b>3SE5 132-0KA00</b>	1	1 unit
	Snap-action contacts	1 NO + 2 NC	—	⊕	B	<b>3SE5 132-0LA00</b>	1	1 unit
	Slow-action contacts with make-before-break	1 NO + 2 NC	—	⊕	B	<b>3SE5 132-0MA00</b>	1	1 unit
Slow-action contacts	2 NO + 1 NC	—	⊕	B	<b>3SE5 132-0PA00</b>	1	1 unit	
	<b>With increased corrosion protection<sup>1)</sup></b>							
	Slow-action contacts	1 NO + 1 NC	—	⊕	B	<b>3SE5 132-0BA00-1CA0</b>	1	1 unit
	Snap-action contacts	1 NO + 1 NC	—	⊕	B	<b>3SE5 132-0CA00-1CA0</b>	1	1 unit
	Slow-action contacts	1 NO + 2 NC	—	⊕	B	<b>3SE5 132-0KA00-1CA0</b>	1	1 unit
	Snap-action contacts	1 NO + 2 NC	—	⊕	B	<b>3SE5 132-0LA00-1CA0</b>	1	1 unit
	Slow-action contacts with make-before-break	1 NO + 2 NC	—	⊕	B	<b>3SE5 132-0MA00-1CA0</b>	1	1 unit
	Slow-action contacts	2 NO + 1 NC	—	⊕	B	<b>3SE5 132-0PA00-1CA0</b>	1	1 unit
	<b>With M12 connector socket, 4-pole (250 V, 4 A)</b>							
	Slow-action contacts	1 NO + 1 NC	—	⊕	B	<b>3SE5 134-0BA00-1AC4</b>	1	1 unit
	Snap-action contacts	1 NO + 1 NC	—	⊕	B	<b>3SE5 134-0CA00-1AC4</b>	1	1 unit
	Slow-action contacts	2 NC	—	⊕	B	<b>3SE5 134-0KA00-1AE0</b>	1	1 unit
	Snap-action contacts	2 NC	—	⊕	B	<b>3SE5 134-0LA00-1AE0</b>	1	1 unit
	<b>With 2 LEDs, yellow/green</b>							
	Slow-action contacts	1 NO + 2 NC	24 V DC	⊕	C	<b>3SE5 132-1KA00</b>	1	1 unit
	Snap-action contacts	1 NO + 2 NC	24 V DC	⊕	C	<b>3SE5 132-1LA00</b>	1	1 unit
	Slow-action contacts	1 NO + 2 NC	230 V AC	⊕	C	<b>3SE5 132-3KA00</b>	1	1 unit
	Snap-action contacts	1 NO + 2 NC	230 V AC	⊕	C	<b>3SE5 132-3LA00</b>	1	1 unit

 For online configurator see [www.siemens.com/sirius/configurators](http://www.siemens.com/sirius/configurators).

 Positive opening according to IEC 60947-5-1, Appendix K, or positively driven actuator, necessary in safety circuits.

<sup>1)</sup> Use corresponding high-grade steel lever.













Note:

Selection aid [see page 13/9](#).

# Limit Switches

## SIRIUS 3SE5 International Limit Switches

3SE5, plastic enclosures  
Enclosure width 40 mm acc. to EN 50041

Version	Diameter	DT	Modular system	Price per PU	PU (UNIT, SET, M)	PS*
	mm		Order No.			
<b>Operating mechanisms</b>						
	<b>Plain plungers</b> High-grade steel plungers	10	⊕ A	<b>3SE5 000-0AB01</b>	1	1 unit
Plain plunger						
	<b>Rounded plungers, type B acc. to EN 50041</b> Plastic plungers	10	⊕ B	<b>3SE5 000-0AC03</b>	1	1 unit
Plunger						
	<b>Roller plungers, type C acc. to EN 50041</b> Plastic plunger, plastic roller Plastic plunger, high-grade steel roller	13 13	⊕ B ⊕ B	<b>3SE5 000-0AD05</b> <b>3SE5 000-0AD06</b>	1 1	1 unit 1 unit
Roller lever						
	<b>Roller levers</b> Metal lever with plastic roller, plastic base	22	⊕ B	<b>3SE5 000-0AE05</b>	1	1 unit
Angular roller lever						
	<b>Angular roller levers</b> Metal lever with plastic roller, plastic base	22	⊕ B	<b>3SE5 000-0AF05</b>	1	1 unit
Spring rod						
	<b>Spring rods</b> (for switches with snap-action contacts only) Plastic plunger and high-grade steel spring: • Length 142.5 mm (spring 50 mm, plunger 50 mm) • Length 76 mm (spring 23.5 mm, plunger 10 mm) • Length 242.5 mm (spring 150 mm, plunger 50 mm) High-grade steel plunger and spring: • Length 142.5 mm (spring 50 mm, plunger 50 mm)	7 7	B B B B	<b>3SE5 000-0AR01</b> <b>3SE5 000-0AR03</b> <b>3SE5 000-0AR04</b> <b>3SE5 000-0AR02</b>	1 1 1 1	1 unit 1 unit 1 unit 1 unit
<b>Twist actuators</b>						
	<b>Twist actuators</b> , plastic (without lever) • For twist levers and rod actuators, switching right and/or left, adjustable		⊕ B	<b>3SE5 000-0AJ00</b>	1	1 unit
Twist actuator						
	<b>Levers for twist actuators</b> <b>Twist levers, offset, type A acc. to EN 50041</b> Metal lever 27 mm, plastic roller Metal lever 27 mm, high-grade steel roller Metal lever 27 mm, roller with ball bearing Metal lever 27 mm, 2 plastic rollers Metal lever 27 mm, plastic roller Metal lever 27 mm, rubber roller High-grade steel lever 27 mm, plastic roller High-grade steel lever 27 mm, high-grade steel roller Metal lever 35 mm, plastic roller	19 19 19 19 30 50 19 19 19	⊕ ▶ ⊕ ▶ ⊕ B ⊕ ▶ ⊕ B ⊕ ▶ ⊕ B ⊕ ▶ ⊕ B	<b>3SE5 000-0AA01</b> <b>3SE5 000-0AA02</b> <b>3SE5 000-0AA03</b> <b>3SE5 000-0AA04</b> <b>3SE5 000-0AA05</b> <b>3SE5 000-0AA08</b> <b>3SE5 000-0AA11</b> <b>3SE5 000-0AA12</b> <b>3SE5 000-0AA15</b>	1 1 1 1 1 1 1 1 1	1 unit 1 unit 1 unit 1 unit 1 unit 1 unit 1 unit 1 unit 1 unit
Twist lever						
	<b>Twist levers 30 mm, straight<sup>1)</sup></b> Metal lever, plastic roller Metal lever, plastic roller	19 30	⊕ B ⊕ B	<b>3SE5 000-0AA24</b> <b>3SE5 000-0AA26</b>	1 1	1 unit 1 unit
Twist lever, adjustable length						
	<b>Twist levers, adjustable length, with grid hole</b> Metal lever, plastic roller Metal lever, high-grade steel roller Metal lever, rubber roller High-grade steel lever, plastic roller High-grade steel lever, high-grade steel roller	19 19 50 19 19	⊕ B ⊕ B ⊕ B ⊕ B ⊕ B	<b>3SE5 000-0AA60</b> <b>3SE5 000-0AA61</b> <b>3SE5 000-0AA68</b> <b>3SE5 000-0AA62</b> <b>3SE5 000-0AA63</b>	1 1 1 1 1	1 unit 1 unit 1 unit 1 unit 1 unit
Twist lever, adjustable length						
	<b>Twist levers, adjustable length</b> Metal lever, plastic roller Metal lever, high-grade steel roller Metal lever, plastic roller Metal lever, rubber roller High-grade steel lever, plastic roller High-grade steel lever, high-grade steel roller	19 19 30 50 19 19	A B B B B B	<b>3SE5 000-0AA50</b> <b>3SE5 000-0AA51</b> <b>3SE5 000-0AA55</b> <b>3SE5 000-0AA58</b> <b>3SE5 000-0AA52</b> <b>3SE5 000-0AA53</b>	1 1 1 1 1 1	1 unit 1 unit 1 unit 1 unit 1 unit 1 unit
Rod actuator						
	<b>Rod actuators, type D acc. to EN 50041</b> Aluminum rod, length 200 mm Spring rod, length 200 mm Plastic rod, length 200 mm	6 6 6	B B B	<b>3SE5 000-0AA80</b> <b>3SE5 000-0AA81</b> <b>3SE5 000-0AA82</b>	1 1 1	1 unit 1 unit 1 unit

⊕ Positively driven actuator, necessary in safety circuits.

<sup>1)</sup> Can be clinch mounted (turned through 180°, rear of lever).

# Limit Switches

## SIRIUS 3SE5 International Limit Switches

3SE5, plastic enclosures  
Enclosure width 50 mm

1  
2  
3  
4  
5  
6  
7  
8  
9  
10  
11  
12  
13

### Selection and ordering data

#### Complete units

2 or 3 contacts · Degree of protection IP66/IP67 · Cable entry 2 × (M20 × 1.5)

Version	Contacts	LEDs	DT	Complete units	PU (UNIT, SET, M)	PS*
				<input type="checkbox"/>		
						
				Order No.	Price per PU	

#### Complete units<sup>1)</sup> · Enclosure width 50 mm



Rounded plunger

##### Rounded plungers

##### With teflon plunger

Slow-action contacts	1 NO + 1 NC	—	⊙ ▶	<b>3SE5 242-0BC05</b>	1	1 unit
Snap-action contacts	1 NO + 1 NC	—	⊙ B	<b>3SE5 242-0CC05</b>	1	1 unit
Snap-action contacts, integrated <sup>2)</sup>	1 NO + 1 NC	—	⊙ ▶	<b>3SE5 242-0HC05</b>	1	1 unit
Snap-action contacts	1 NO + 1 NC	—	⊙ B	<b>3SE5 242-0FC05</b>	1	1 unit
• Short stroke, integrated <sup>2)</sup>						
Snap-action contacts	1 NO + 1 NC	—	⊙ B	<b>3SE5 242-0GC05</b>	1	1 unit
• 2 × 2 mm contact gap						
Slow-action contacts	1 NO + 2 NC	—	⊙ B	<b>3SE5 242-0KC05</b>	1	1 unit
Snap-action contacts	1 NO + 2 NC	—	⊙ B	<b>3SE5 242-0LC05</b>	1	1 unit
Slow-action contacts with make-before-break	1 NO + 2 NC	—	⊙ A	<b>3SE5 242-0MC05</b>	1	1 unit
Slow-action contacts	2 NO + 1 NC	—	⊙ A	<b>3SE5 242-0PC05</b>	1	1 unit



With increased corrosion protection

##### With increased corrosion protection

Slow-action contacts	1 NO + 1 NC	—	⊙ B	<b>3SE5 242-0BC05-1CA0</b>	1	1 unit
Snap-action contacts, integrated <sup>2)</sup>	1 NO + 1 NC	—	⊙ B	<b>3SE5 242-0HC05-1CA0</b>	1	1 unit
Slow-action contacts	1 NO + 2 NC	—	⊙ B	<b>3SE5 242-0KC05-1CA0</b>	1	1 unit
Snap-action contacts	1 NO + 2 NC	—	⊙ B	<b>3SE5 242-0LC05-1CA0</b>	1	1 unit
Slow-action contacts with make-before-break	1 NO + 2 NC	—	⊙ B	<b>3SE5 242-0MC05-1CA0</b>	1	1 unit
Slow-action contacts	2 NO + 1 NC	—	⊙ B	<b>3SE5 242-0PC05-1CA0</b>	1	1 unit



With 2 LEDs

##### With 2 LEDs, yellow/green

Slow-action contacts	1 NO + 2 NC	24 V DC	⊙ B	<b>3SE5 242-1KC05</b>	1	1 unit
Snap-action contacts	1 NO + 2 NC	24 V DC	⊙ B	<b>3SE5 242-1LC05</b>	1	1 unit
Slow-action contacts	1 NO + 2 NC	230 V AC	⊙ B	<b>3SE5 242-3KC05</b>	1	1 unit
Snap-action contacts	1 NO + 2 NC	230 V AC	⊙ B	<b>3SE5 242-3LC05</b>	1	1 unit



Roller plunger

##### Roller plungers

##### With plastic roller 10 mm

Slow-action contacts	1 NO + 1 NC	—	⊙ ▶	<b>3SE5 242-0BD03</b>	1	1 unit
Snap-action contacts, integrated <sup>2)</sup>	1 NO + 1 NC	—	⊙ ▶	<b>3SE5 242-0HD03</b>	1	1 unit
Snap-action contacts	1 NO + 2 NC	—	⊙ ▶	<b>3SE5 242-0LD03</b>	1	1 unit

 For online configurator see [www.siemens.com/sirius/configurators](http://www.siemens.com/sirius/configurators).

⊙ Positive opening according to IEC 60947-5-1, Appendix K.

<sup>1)</sup> Popular versions.

<sup>2)</sup> Subsequent replacement of contact blocks is not possible.

# Limit Switches

## SIRIUS 3SE5 International Limit Switches

**3SE5, plastic enclosures**  
**Enclosure width 50 mm**

2 or 3 contacts · Degree of protection IP66/IP67 · Cable entry 2 × (M20 × 1.5)

Version	Contacts	LEDs	DT	Complete units	<input type="checkbox"/>	PU (UNIT, SET, M)	PS*
				<b>Configurator</b>			
				Order No.	Price per PU		

### Complete units<sup>1)</sup> · Enclosure width 50 mm



Roller lever

#### Roller levers

##### With metal lever and plastic roller 13 mm

Slow-action contacts	1 NO + 1 NC	—		B	<b>3SE5 242-0BE10</b>	1	1 unit
Snap-action contacts, integrated <sup>2)</sup>	1 NO + 1 NC	—			<b>3SE5 242-0HE10</b>	1	1 unit
Snap-action contacts	1 NO + 2 NC	—		B	<b>3SE5 242-0LE10</b>	1	1 unit
<b>With M12 connector socket, 4-pole right (250 V, 4 A)</b>							
Snap-action contacts	2 NC	—		B	<b>3SE5 244-0LE10-1AE0</b>	1	1 unit



Twist lever

#### Twist levers

##### With metal lever 21 mm and plastic roller 19 mm

Slow-action contacts	1 NO + 1 NC	—		B	<b>3SE5 242-0BK21</b>	1	1 unit
Snap-action contacts, integrated <sup>2)</sup>	1 NO + 1 NC	—			<b>3SE5 242-0HK21</b>	1	1 unit
Snap-action contacts	1 NO + 2 NC	—		B	<b>3SE5 242-0LK21</b>	1	1 unit

#### Twist levers, adjustable length

##### With metal lever and plastic roller 19 mm

Snap-action contacts, integrated <sup>2)</sup>	1 NO + 1 NC	—		B	<b>3SE5 242-0HK50</b>	1	1 unit
--	-------------	---	--	---	-----------------------	---	--------

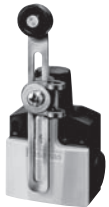

Twist lever, adjustable length

For online configurator see [www.siemens.com/sirius/configurators](http://www.siemens.com/sirius/configurators).

Positive opening according to IEC 60947-5-1, Appendix K.

<sup>1)</sup> Popular versions.

<sup>2)</sup> Subsequent replacement of contact blocks is not possible.

#### Note:

If the device you require is not available as a complete unit, see "Modular System", page 13/21.

# Limit Switches

## SIRIUS 3SE5 International Limit Switches

3SE5, plastic enclosures  
Enclosure width 50 mm

1  
2  
3  
4  
5  
6  
7  
8  
9  
10  
11  
12  
13

### Modular system

2 or 3 contacts · Degree of protection IP66/IP67 · Cable entry 2 × (M20 × 1.5)

Version	Contacts	LEDs	DT	Modular system	PU (UNIT, SET, M)	PS*
				Order No.	Price per PU	

### Basic switches · Enclosure width 50 mm (with rounded plunger<sup>1)</sup>)

	<b>With teflon plunger</b>					
	Slow-action contacts	1 NO + 1 NC	—	⊕ ▶	<b>3SE5 242-0BC05</b>	1 1 unit
	Snap-action contacts	1 NO + 1 NC	—	⊕ B	<b>3SE5 242-0CC05</b>	1 1 unit
	Snap-action contacts, integrated <sup>2)</sup>	1 NO + 1 NC	—	⊕ ▶	<b>3SE5 242-0HC05</b>	1 1 unit
	Snap-action contacts • Short stroke, integrated <sup>2)</sup>	1 NO + 1 NC	—	⊕ B	<b>3SE5 242-0FC05</b>	1 1 unit
	Snap-action contacts • 2 × 2 mm contact gap	1 NO + 1 NC	—	⊕ B	<b>3SE5 242-0GC05</b>	1 1 unit
	Slow-action contacts	1 NO + 2 NC	—	⊕ B	<b>3SE5 242-0KC05</b>	1 1 unit
	Snap-action contacts	1 NO + 2 NC	—	⊕ B	<b>3SE5 242-0LC05</b>	1 1 unit
	Slow-action contacts with make-before-break	1 NO + 2 NC	—	⊕ A	<b>3SE5 242-0MC05</b>	1 1 unit
Slow-action contacts	2 NO + 1 NC	—	⊕ A	<b>3SE5 242-0PC05</b>	1 1 unit	
	<b>With increased corrosion protection<sup>3)</sup></b>					
	Slow-action contacts	1 NO + 1 NC	—	⊕ B	<b>3SE5 242-0BC05-1CA0</b>	1 1 unit
	Snap-action contacts, integrated <sup>2)</sup>	1 NO + 1 NC	—	⊕ B	<b>3SE5 242-0HC05-1CA0</b>	1 1 unit
	Slow-action contacts	1 NO + 2 NC	—	⊕ B	<b>3SE5 242-0KC05-1CA0</b>	1 1 unit
	Snap-action contacts	1 NO + 2 NC	—	⊕ B	<b>3SE5 242-0LC05-1CA0</b>	1 1 unit
	Slow-action contacts with make-before-break	1 NO + 2 NC	—	⊕ B	<b>3SE5 242-0MC05-1CA0</b>	1 1 unit
	<b>With 2 LEDs, yellow/green</b>					
	Slow-action contacts	1 NO + 2 NC	24 V DC	⊕ B	<b>3SE5 242-1KC05</b>	1 1 unit
	Snap-action contacts	1 NO + 2 NC	24 V DC	⊕ B	<b>3SE5 242-1LC05</b>	1 1 unit
	Slow-action contacts	1 NO + 2 NC	230 V AC	⊕ B	<b>3SE5 242-3KC05</b>	1 1 unit
	Snap-action contacts	1 NO + 2 NC	230 V AC	⊕ B	<b>3SE5 242-3LC05</b>	1 1 unit

For online configurator see [www.siemens.com/sirius/configurators](http://www.siemens.com/sirius/configurators).

Positive opening according to IEC 60947-5-1, Appendix K, or positively driven actuator, necessary in safety circuits.

<sup>1)</sup> For enclosures with widths of 50 mm, the basic switch is a complete unit with rounded plungers.

<sup>2)</sup> Subsequent replacement of contact blocks is not possible.

<sup>3)</sup> Use corresponding high-grade steel lever.

Note:

Selection aid [see page 13/9](#).

Version	Diameter	DT	Modular system	PU (UNIT, SET, M)	PS*
	mm				
			Order No.	Price per PU	

### Operating mechanisms







	<b>Roller plungers, type C acc. to EN 50047</b>					
	Plastic rollers	10	⊕ A	<b>3SE5 000-0AD03</b>	1 1 unit	
	High-grade steel rollers	10	⊕ B	<b>3SE5 000-0AD04</b>	1 1 unit	
	<b>Roller plungers with central fixing</b>					
	Plastic rollers	10	⊕ B	<b>3SE5 000-0AD10</b>	1 1 unit	
	High-grade steel rollers	10	⊕ B	<b>3SE5 000-0AD11</b>	1 1 unit	

Positively driven actuator, necessary in safety circuits.

# Limit Switches

## SIRIUS 3SE5 International Limit Switches

3SE5, plastic enclosures  
Enclosure width 50 mm

Version	Diameter	DT	Modular system	PU (UNIT, SET, M)	PS*
	mm		Order No.	Price per PU	
<b>Operating mechanisms</b>					
	<b>Roller levers, type E acc. to EN 50047</b>				
	Metal lever, plastic roller	13	⊕ A	<b>3SE5 000-0AE10</b>	1 1 unit
	Metal lever, high-grade steel roller	13	⊕ B	<b>3SE5 000-0AE11</b>	1 1 unit
	High-grade steel lever, plastic roller	13	⊕ B	<b>3SE5 000-0AE12</b>	1 1 unit
	<b>Angular roller levers</b>				
	Metal lever, plastic roller	13	⊕ A	<b>3SE5 000-0AF10</b>	1 1 unit
	Metal lever, high-grade steel roller	13	⊕ B	<b>3SE5 000-0AF11</b>	1 1 unit
	High-grade steel lever, plastic roller	13	⊕ A	<b>3SE5 000-0AF12</b>	1 1 unit
	<b>Spring rods</b> (for switches with snap-action contacts only)				
	Plastic plunger and high-grade steel spring:	7			
	• Length 142.5 mm (spring 50 mm, plunger 50 mm)		B	<b>3SE5 000-0AR01</b>	1 1 unit
	• Length 76 mm (spring 23.5 mm, plunger 10 mm)		B	<b>3SE5 000-0AR03</b>	1 1 unit
	<b>Twist actuators</b>				
	<b>Twist actuators, plastic (without lever)</b>				
	Switching right and/or left, adjustable		⊕ A	<b>3SE5 000-0AK00</b>	1 1 unit
	<b>Levers for twist actuators</b>				
	<b>Twist levers 21 mm, straight, type A acc. to EN 50047</b>				
	Metal lever, plastic roller	19	⊕ A	<b>3SE5 000-0AA21</b>	1 1 unit
	Metal lever, high-grade steel roller	19	⊕ B	<b>3SE5 000-0AA22</b>	1 1 unit
	Metal lever, roller with ball bearing	19	⊕ B	<b>3SE5 000-0AA23</b>	1 1 unit
	<b>Twist levers 30 mm, straight<sup>1)</sup></b>				
	Metal lever, plastic roller	30	⊕ B	<b>3SE5 000-0AA25</b>	1 1 unit
	High-grade steel lever, plastic roller	19	⊕ B	<b>3SE5 000-0AA31</b>	1 1 unit
	High-grade steel lever, high-grade steel roller	19	⊕ B	<b>3SE5 000-0AA32</b>	1 1 unit
	<b>Twist levers, adjustable length, with grid hole</b>				
	Metal lever, plastic roller	19	⊕ B	<b>3SE5 000-0AA24</b>	1 1 unit
	Metal lever, plastic roller	30	⊕ B	<b>3SE5 000-0AA26</b>	1 1 unit
	Metal lever, plastic roller	19	⊕ B	<b>3SE5 000-0AA60</b>	1 1 unit
	<b>Twist levers, adjustable length</b>				
	Metal lever, high-grade steel roller	19	⊕ B	<b>3SE5 000-0AA61</b>	1 1 unit
	Metal lever, plastic roller	50	⊕ B	<b>3SE5 000-0AA67</b>	1 1 unit
	Metal lever, rubber roller	50	⊕ B	<b>3SE5 000-0AA68</b>	1 1 unit
	<b>Twist levers, adjustable length</b>				
	High-grade steel lever, plastic roller	19	⊕ B	<b>3SE5 000-0AA62</b>	1 1 unit
	High-grade steel lever, high-grade steel roller	19	⊕ B	<b>3SE5 000-0AA63</b>	1 1 unit
	Metal lever, plastic roller	19	A	<b>3SE5 000-0AA50</b>	1 1 unit
	<b>Rod actuators</b>				
	Metal lever, high-grade steel roller	19	B	<b>3SE5 000-0AA51</b>	1 1 unit
	Metal lever, plastic roller	30	B	<b>3SE5 000-0AA55</b>	1 1 unit
	Metal lever, plastic roller	50	B	<b>3SE5 000-0AA57</b>	1 1 unit
	<b>Rod actuators</b>				
	Metal lever, rubber roller	50	B	<b>3SE5 000-0AA58</b>	1 1 unit
	High-grade steel lever, plastic roller	19	B	<b>3SE5 000-0AA52</b>	1 1 unit
	High-grade steel lever, high-grade steel roller	19	B	<b>3SE5 000-0AA53</b>	1 1 unit
	Aluminum rod, length 200 mm	6	B	<b>3SE5 000-0AA80</b>	1 1 unit
	Spring rod, length 200 mm	6	B	<b>3SE5 000-0AA81</b>	1 1 unit
	Plastic rod, length 200 mm	6	B	<b>3SE5 000-0AA82</b>	1 1 unit

⊕ Positively driven actuator, necessary in safety circuits.

<sup>1)</sup> Can be clinch mounted (turned through 180°, rear of lever).

# Limit Switches

## SIRIUS 3SE5 International Limit Switches

3SE5, plastic enclosures  
Ambient temperature to -40 °C

1  
2  
3  
4  
5  
6  
7  
8  
9  
10  
11  
12  
13

### Selection and ordering data

#### Complete units

2 or 3 contacts · Degree of protection IP65 or IP66/IP67 · Cable entry M20 × 1.5

Version	Contacts	LEDs	DT	Complete units	<input type="checkbox"/>	PU (UNIT, SET, M)	PS*	PG
				<b>Configurator</b>				
				Order No.		Price per PU		

#### Complete units<sup>1)</sup> · Enclosure width 31 mm



Roller plunger  
with central  
fixing

##### Roller plungers with central fixing

Snap-action contacts	1 NO + 1 NC	—	⊕ B	<b>3SE5 232-0CD10-1AJ0</b>	1	1 unit	41K
----------------------	-------------	---	-----	----------------------------	---	--------	-----



Twist lever

##### Twist levers, type A acc. to EN 50047

With high-grade steel lever 21 mm and plastic roller 19 mm

Snap-action contacts	1 NO + 1 NC	—	⊕ A	<b>3SE5 232-0CK31-1AJ0</b>	1	1 unit	41K
----------------------	-------------	---	-----	----------------------------	---	--------	-----



Twist lever,  
adjustable  
length

##### Twist levers, adjustable length

With high-grade steel lever with grid hole  
and plastic roller 19 mm

Snap-action contacts	1 NO + 1 NC	—	⊕ A	<b>3SE5 232-0CK62-1AJ0</b>	1	1 unit	41K
----------------------	-------------	---	-----	----------------------------	---	--------	-----

Snap-action contacts	1 NO + 2 NC	—	⊕ B	<b>3SE5 232-0LK62-1AJ0</b>	1	1 unit	41K
----------------------	-------------	---	-----	----------------------------	---	--------	-----

#### Complete units<sup>1)</sup> · Enclosure width 50 mm

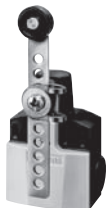

Twist lever,  
adjustable  
length

##### Twist levers

With metal lever 21 mm and plastic roller 19 mm

Snap-action contacts, integrated <sup>2)</sup>	1 NO + 1 NC	—	⊕ B	<b>3SE5 242-0HK21-1AJ0</b>	1	1 unit	41K
--	-------------	---	-----	----------------------------	---	--------	-----

##### Twist levers, adjustable length

With high-grade steel lever with grid hole and plastic roller  
19 mm

Snap-action contacts, integrated <sup>2)</sup>	1 NO + 1 NC	—	⊕ B	<b>3SE5 242-0HK62-1AJ0</b>	1	1 unit	41K
--	-------------	---	-----	----------------------------	---	--------	-----

For online configurator see [www.siemens.com/sirius/configurators](http://www.siemens.com/sirius/configurators).

Positive opening according to IEC 60947-5-1, Appendix K, or positively driven actuator, necessary in safety circuits.

<sup>1)</sup> Popular versions.

<sup>2)</sup> Subsequent replacement of contact blocks is not possible.

#### Note:

If the device you require is not available as a complete unit, see "Modular System", see page 13/24.

# Limit Switches

## SIRIUS 3SE5 International Limit Switches

**3SE5, plastic enclosures**  
**Ambient temperature to -40 °C**

### Modular system

2 or 3 contacts · Degree of protection IP65 or IP66/IP67 · Cable entry M20 × 1.5

Version	Contacts	LEDs	DT	Modular system	Configurator	Order No.	Price per PU	PU (UNIT, SET, M)	PS*

### Basic switches · Enclosure width 31 mm (with rounded plunger<sup>1)</sup>)



#### With teflon plunger

Snap-action contacts	1 NO + 1 NC	—	⊕ B	<b>3SE5 232-0CC05-1AJ0</b>	1	1 unit
Slow-action contacts	1 NO + 2 NC	—	⊕ B	<b>3SE5 232-0KC05-1AJ0</b>	1	1 unit
Snap-action contacts	1 NO + 2 NC	—	⊕ B	<b>3SE5 232-0LC05-1AJ0</b>	1	1 unit

Basic switch

### Basic switches · Enclosure width 50 mm (with rounded plunger<sup>1)</sup>)



#### With teflon plunger

Slow-action contacts	1 NO + 1 NC	—	⊕ B	<b>3SE5 242-0BC05-1AJ0</b>	1	1 unit
Snap-action contacts, integrated <sup>2)</sup>	1 NO + 1 NC	—	⊕ B	<b>3SE5 242-0HC05-1AJ0</b>	1	1 unit

Basic switch

⚙ For online configurator see [www.siemens.com/sirius/configurators](http://www.siemens.com/sirius/configurators).

⊕ Positive opening according to IEC 60947-5-1, Appendix K, or positively driven actuator, necessary in safety circuits.

<sup>1)</sup> For enclosures with widths of 31 and 50 mm, the basic switch is a complete unit with rounded plungers.

<sup>2)</sup> Subsequent replacement of contact blocks is not possible.

Note:

Selection aid [see page 13/9](#).









# Limit Switches

## SIRIUS 3SE5 International Limit Switches

3SE5, plastic enclosures  
Ambient temperature to -40 °C

1  
2  
3  
4  
5  
6  
7  
8  
9  
10  
11  
12  
13

Version	Diameter	DT	Modular system	PU (UNIT, SET, M)	PS*
	mm		Order No. Price per PU		
<b>Operating mechanisms</b>					
 Roller plunger	<b>Roller plungers, type C acc. to EN 50047</b>				
	Plastic rollers	10	⊕ B	<b>3SE5 000-0AD03-1AJ0</b>	1 1 unit
 Roller lever	<b>Roller levers, type E acc. to EN 50047</b>				
	Metal lever, plastic roller	13	⊕ B	<b>3SE5 000-0AE10-1AJ0</b>	1 1 unit
	High-grade steel lever, plastic roller	13	⊕ B	<b>3SE5 000-0AE12-1AJ0</b>	1 1 unit
 Angular roller lever	<b>Angular roller levers</b>				
	Metal lever, plastic roller	13	⊕ B	<b>3SE5 000-0AF10-1AJ0</b>	1 1 unit
	High-grade steel lever, plastic roller	13	⊕ B	<b>3SE5 000-0AF12-1AJ0</b>	1 1 unit
<b>Twist actuators</b>					
 Twist actuator	<b>Twist actuators, plastic (without lever)</b>				
	Switching right and/or left, adjustable		⊕ B	<b>3SE5 000-0AK00-1AJ0</b>	1 1 unit
<b>Levers for twist actuators</b>					
 Twist lever	<b>Twist levers straight, 21 mm, type A acc. to EN 50047</b>				
	Metal lever, plastic roller	19	⊕ B	<b>3SE5 000-0AA21-1AJ0</b>	1 1 unit
	High-grade steel lever, plastic roller	19	⊕ B	<b>3SE5 000-0AA31-1AJ0</b>	1 1 unit
 Twist lever, adjustable length	<b>Twist levers, adjustable length, with grid hole</b>				
	Metal lever, plastic roller	19	⊕ B	<b>3SE5 000-0AA60-1AJ0</b>	1 1 unit
	High-grade steel lever, plastic roller	19	⊕ B	<b>3SE5 000-0AA62-1AJ0</b>	1 1 unit

⊕ Positively driven actuator, necessary in safety circuits.

# Limit Switches

## SIRIUS 3SE5 International Limit Switches

**3SE5, plastic enclosures**  
Ambient temperature to **-40 °C**

### Modular system

2 or 3 contacts · Degree of protection IP66/IP67 · Cable entry M20 × 1.5

Version	Contacts	LEDs	DT	Modular system	PU (UNIT, SET, M)	PS*
				Order No.	Price per PU	

### Basic switches · Enclosure width 40 mm



#### With M20 □ 1.5 connecting thread

Snap-action contacts	1 NO + 1 NC	—		B	<b>3SE5 132-0CA00-1AJ0</b>	1	1 unit
Slow-action contacts	1 NO + 2 NC	—		B	<b>3SE5 132-0KA00-1AJ0</b>	1	1 unit
Snap-action contacts	1 NO + 2 NC	—		B	<b>3SE5 132-0LA00-1AJ0</b>	1	1 unit

Basic switch

For online configurator see [www.siemens.com/sirius/configurators](http://www.siemens.com/sirius/configurators).

Positive opening according to IEC 60947-5-1, Appendix K, or positively driven actuator, necessary in safety circuits.

Note:

Selection aid [see page 13/9](#).

Version	Diameter	DT	Modular system	PU (UNIT, SET, M)	PS*
	mm				
			Order No.	Price per PU	

### Operating mechanisms



#### Rounded plungers, type B acc. to EN 50041

Plastic plunger	10		B	<b>3SE5 000-0AC03-1AJ0</b>	1	1 unit
-----------------	----	--	---	----------------------------	---	--------

Rounded plunger



#### Roller plungers, type C acc. to EN 50041

Plastic plunger, plastic roller	13		B	<b>3SE5 000-0AD05-1AJ0</b>	1	1 unit
---------------------------------	----	--	---	----------------------------	---	--------

Roller plunger



#### Roller levers

Metal lever with plastic roller, plastic base	22		B	<b>3SE5 000-0AE05-1AJ0</b>	1	1 unit
---	----	--	---	----------------------------	---	--------

Roller lever

### Twist actuators



#### Twist actuators, plastic (without lever)

• For twist levers and rod actuators, switching right and/or left, adjustable			B	<b>3SE5 000-0AJ00-1AJ0</b>	1	1 unit
---	--	--	---	----------------------------	---	--------

Twist actuator

#### Levers for twist actuators

##### Twist lever, type A acc. to EN 50041

Metal lever, plastic roller	19		B	<b>3SE5 000-0AA01-1AJ0</b>	1	1 unit
High-grade steel lever, plastic roller	19		B	<b>3SE5 000-0AA11-1AJ0</b>	1	1 unit

Twist levers

##### Twist levers, adjustable length, with grid hole

Metal lever, plastic roller	19		B	<b>3SE5 000-0AA60-1AJ0</b>	1	1 unit
High-grade steel lever, plastic roller	19		B	<b>3SE5 000-0AA62-1AJ0</b>	1	1 unit

Twist lever, adjustable length

Positively driven actuator, necessary in safety circuits.

# Limit Switches

## SIRIUS 3SE5 International Limit Switches

3SE5, metal enclosures  
Enclosure width 31 mm acc. to EN 50047

1

2

3

4

5

6

7

8

9

10

11

12

13







### Selection and ordering data

#### Complete units

2 or 3 contacts · Degree of protection IP66/IP67 · Cable entry M20 × 1.5

Version	Contacts	LEDs	DT	Complete units	<input type="checkbox"/>	PU (UNIT, SET, M)	PS*
				<b>Configurator</b>			
				Order No.		Price per PU	

#### Complete units<sup>1)</sup> · Enclosure width 31 mm

	<b>Rounded plungers, type B, acc. to EN 50047</b>							
	<b>With plunger</b>							
	Slow-action contacts	1 NO + 1 NC	—	⊕ A	<b>3SE5 212-0BC05</b>		1	1 unit
	Snap-action contacts	1 NO + 1 NC	—	⊕ A	<b>3SE5 212-0CC05</b>		1	1 unit
	Slow-action contacts	1 NO + 2 NC	—	⊕ A	<b>3SE5 212-0KC05</b>		1	1 unit
	Snap-action contacts	1 NO + 2 NC	—	⊕ A	<b>3SE5 212-0LC05</b>		1	1 unit
	Slow-action contacts with make-before-break	1 NO + 2 NC	—	⊕ A	<b>3SE5 212-0MC05</b>		1	1 unit
Slow-action contacts	2 NO + 1 NC	—	⊕ A	<b>3SE5 212-0PC05</b>		1	1 unit	
	<b>With increased corrosion protection</b>							
	Slow-action contacts	1 NO + 1 NC	—	⊕ B	<b>3SE5 212-0BC05-1CA0</b>		1	1 unit
	Snap-action contacts	1 NO + 1 NC	—	⊕ B	<b>3SE5 212-0CC05-1CA0</b>		1	1 unit
	Slow-action contacts	1 NO + 2 NC	—	⊕ B	<b>3SE5 212-0KC05-1CA0</b>		1	1 unit
	Snap-action contacts	1 NO + 2 NC	—	⊕ B	<b>3SE5 212-0LC05-1CA0</b>		1	1 unit
	Slow-action contacts with make-before-break	1 NO + 2 NC	—	⊕ B	<b>3SE5 212-0MC05-1CA0</b>		1	1 unit
	Slow-action contacts	2 NO + 1 NC	—	⊕ B	<b>3SE5 212-0PC05-1CA0</b>		1	1 unit
	<b>With M12 connector socket, 5-pole (125 V, 4 A)</b>							
	Slow-action contacts	1 NO + 1 NC	—	⊕ B	<b>3SE5 214-0BC05-1AC5</b>		1	1 unit
	Snap-action contacts	1 NO + 1 NC	—	⊕ B	<b>3SE5 214-0CC05-1AC5</b>		1	1 unit
	Slow-action contacts	2 NC	—	⊕ B	<b>3SE5 214-0KC05-1AE1</b>		1	1 unit
	Snap-action contacts	2 NC	—	⊕ B	<b>3SE5 214-0LC05-1AE1</b>		1	1 unit
	<b>With 2 LEDs, yellow/green</b>							
	Slow-action contacts	1 NO + 2 NC	24 V DC	⊕ B	<b>3SE5 212-1KC05</b>		1	1 unit
	Snap-action contacts	1 NO + 2 NC	24 V DC	⊕ A	<b>3SE5 212-1LC05</b>		1	1 unit
	Slow-action contacts	1 NO + 2 NC	230 V AC	⊕ B	<b>3SE5 212-3KC05</b>		1	1 unit
	Snap-action contacts	1 NO + 2 NC	230 V AC	⊕ B	<b>3SE5 212-3LC05</b>		1	1 unit
	<b>With M12 connector socket, 5-pole (125 V, 4 A) and 2 LEDs</b>							
	Slow-action contacts	1 NO + 1 NC	24 V DC	⊕ B	<b>3SE5 214-1BC05-1AF3</b>		1	1 unit
	Snap-action contacts	1 NO + 1 NC	24 V DC	⊕ B	<b>3SE5 214-1CC05-1AF3</b>		1	1 unit
	<b>Plain plungers</b>							
	<b>With high-grade steel plunger</b>							
	Slow-action contacts	1 NO + 1 NC	—	⊕ B	<b>3SE5 212-0BB01</b>		1	1 unit
	Snap-action contacts	1 NO + 1 NC	—	⊕ B	<b>3SE5 212-0CB01</b>		1	1 unit
	Slow-action contacts	1 NO + 2 NC	—	⊕ B	<b>3SE5 212-0KB01</b>		1	1 unit
Snap-action contacts	1 NO + 2 NC	—	⊕ B	<b>3SE5 212-0LB01</b>		1	1 unit	
	<b>Roller plungers, type C acc. to EN 50047</b>							
	<b>With plastic roller 10 mm</b>							
	Slow-action contacts	1 NO + 1 NC	—	⊕ A	<b>3SE5 212-0BD03</b>		1	1 unit
	Snap-action contacts	1 NO + 1 NC	—	⊕ B	<b>3SE5 212-0CD03</b>		1	1 unit
	Slow-action contacts	1 NO + 2 NC	—	⊕ A	<b>3SE5 212-0KD03</b>		1	1 unit
Snap-action contacts	1 NO + 2 NC	—	⊕ B	<b>3SE5 212-0LD03</b>		1	1 unit	

For online configurator see [www.siemens.com/sirius/configurators](http://www.siemens.com/sirius/configurators).

⊕ Positive opening according to IEC 60947-5-1, Appendix K.

<sup>1)</sup> Popular versions.

# Limit Switches

## SIRIUS 3SE5 International Limit Switches

**3SE5, metal enclosures**  
**Enclosure width 31 mm acc. to EN 50047**

2 or 3 contacts · Degree of protection IP66/IP67 · Cable entry M20 × 1.5

Version	Contacts	LEDs	DT	Complete units	<input type="checkbox"/>	PU (UNIT, SET, M)	PS*
				<b>Configurator</b>			
				Order No.	Price per PU		

### Complete units<sup>1)</sup> · Enclosure width 31 mm



Roller lever

#### Roller levers, type E acc. to EN 50047

##### With metal lever and plastic roller 13 mm

Slow-action contacts	1 NO + 1 NC	—	⊕ A	<b>3SE5 212-0BE10</b>		1	1 unit
Snap-action contacts	1 NO + 1 NC	—	⊕ B	<b>3SE5 212-0CE10</b>		1	1 unit
Slow-action contacts	1 NO + 2 NC	—	⊕ B	<b>3SE5 212-0KE10</b>		1	1 unit
Snap-action contacts	1 NO + 2 NC	—	⊕ B	<b>3SE5 212-0LE10</b>		1	1 unit

#### Angular roller levers

##### With metal lever and plastic roller 13 mm

Slow-action contacts	1 NO + 1 NC	—	⊕ B	<b>3SE5 212-0BF10</b>		1	1 unit
Snap-action contacts	1 NO + 1 NC	—	⊕ B	<b>3SE5 212-0CF10</b>		1	1 unit
Slow-action contacts	1 NO + 2 NC	—	⊕ B	<b>3SE5 212-0KF10</b>		1	1 unit
Snap-action contacts	1 NO + 2 NC	—	⊕ B	<b>3SE5 212-0LF10</b>		1	1 unit



Angular roller lever

#### Twist levers, type A acc. to EN 50047

##### With metal lever 21 mm and plastic roller 19 mm

Slow-action contacts	1 NO + 1 NC	—	⊕ A	<b>3SE5 212-0BK21</b>		1	1 unit
Snap-action contacts	1 NO + 1 NC	—	⊕ A	<b>3SE5 212-0CK21</b>		1	1 unit
Slow-action contacts	1 NO + 2 NC	—	⊕ B	<b>3SE5 212-0KK21</b>		1	1 unit
Snap-action contacts	1 NO + 2 NC	—	⊕ B	<b>3SE5 212-0LK21</b>		1	1 unit



Twist lever

#### Twist levers, adjustable length

##### With metal lever with grid hole and plastic roller 19 mm

Snap-action contacts	1 NO + 1 NC	—	⊕ A	<b>3SE5 212-0CK60</b>		1	1 unit
Slow-action contacts	1 NO + 2 NC	—	⊕ B	<b>3SE5 212-0KK60</b>		1	1 unit
Snap-action contacts	1 NO + 2 NC	—	⊕ B	<b>3SE5 212-0LK60</b>		1	1 unit



Twist lever, adjustable length

##### With metal lever and plastic roller 19 mm

Slow-action contacts	1 NO + 1 NC	—	A	<b>3SE5 212-0BK50</b>		1	1 unit
Snap-action contacts	1 NO + 1 NC	—	B	<b>3SE5 212-0CK50</b>		1	1 unit
Snap-action contacts	1 NO + 2 NC	—	B	<b>3SE5 212-0LK50</b>		1	1 unit

For online configurator see [www.siemens.com/sirius/configurators](http://www.siemens.com/sirius/configurators).

Positive opening according to IEC 60947-5-1, Appendix K.

<sup>1)</sup> Popular versions.

#### Note:

If the device you require is not available as a complete unit, see "Modular System", see page 13/29.

# Limit Switches

## SIRIUS 3SE5 International Limit Switches

3SE5, metal enclosures  
Enclosure width 31 mm acc. to EN 50047





1  
2  
3  
4  
5  
6  
7  
8  
9  
10  
11  
12  
13

### Modular system

2 or 3 contacts · Degree of protection IP66/IP67 · Cable entry M20 × 1.5

Version	Contacts	LEDs	DT	Modular system	☒	PU (UNIT, SET, M)	PS*
				<b>Configurator</b>	⚙️		
				Order No.	Price per PU		

### Basic switches · Enclosure width 31 mm (with rounded plunger<sup>1)</sup>)

Version	Contacts	LEDs	DT	Modular system	☒	PU (UNIT, SET, M)	PS*
 Basic switch	<b>With plunger</b>						
	Slow-action contacts	1 NO + 1 NC	—	⊕ A	<b>3SE5 212-0BC05</b>	1	1 unit
	Snap-action contacts	1 NO + 1 NC	—	⊕ A	<b>3SE5 212-0CC05</b>	1	1 unit
	Slow-action contacts	1 NO + 2 NC	—	⊕ A	<b>3SE5 212-0KC05</b>	1	1 unit
	Snap-action contacts	1 NO + 2 NC	—	⊕ A	<b>3SE5 212-0LC05</b>	1	1 unit
	Slow-action contacts with make-before-break	1 NO + 2 NC	—	⊕ A	<b>3SE5 212-0MC05</b>	1	1 unit
Slow-action contacts	2 NO + 1 NC	—	⊕ A	<b>3SE5 212-0PC05</b>	1	1 unit	
 With increased corrosion protection	<b>With increased corrosion protection<sup>2)</sup></b>						
	Slow-action contacts	1 NO + 1 NC	—	⊕ B	<b>3SE5 212-0BC05-1CA0</b>	1	1 unit
	Snap-action contacts	1 NO + 1 NC	—	⊕ B	<b>3SE5 212-0CC05-1CA0</b>	1	1 unit
	Slow-action contacts	1 NO + 2 NC	—	⊕ B	<b>3SE5 212-0KC05-1CA0</b>	1	1 unit
	Snap-action contacts	1 NO + 2 NC	—	⊕ B	<b>3SE5 212-0LC05-1CA0</b>	1	1 unit
	Slow-action contacts with make-before-break	1 NO + 2 NC	—	⊕ B	<b>3SE5 212-0MC05-1CA0</b>	1	1 unit
Slow-action contacts	2 NO + 1 NC	—	⊕ B	<b>3SE5 212-0PC05-1CA0</b>	1	1 unit	
 With M12 socket	<b>With M12 connector socket, 5-pole (125 V, 4 A)</b>						
	Slow-action contacts	1 NO + 1 NC	—	⊕ B	<b>3SE5 214-0BC05-1AC5</b>	1	1 unit
	Snap-action contacts	1 NO + 1 NC	—	⊕ B	<b>3SE5 214-0CC05-1AC5</b>	1	1 unit
	Slow-action contacts	2 NC	—	⊕ B	<b>3SE5 214-0KC05-1AE1</b>	1	1 unit
	Snap-action contacts	2 NC	—	⊕ B	<b>3SE5 214-0LC05-1AE1</b>	1	1 unit
 With 2 LEDs	<b>With 2 LEDs, yellow/green</b>						
	Slow-action contacts	1 NO + 2 NC	24 V DC	⊕ B	<b>3SE5 212-1KC05</b>	1	1 unit
	Snap-action contacts	1 NO + 2 NC	24 V DC	⊕ A	<b>3SE5 212-1LC05</b>	1	1 unit
	Slow-action contacts	1 NO + 2 NC	230 V AC	⊕ B	<b>3SE5 212-3KC05</b>	1	1 unit
	Snap-action contacts	1 NO + 2 NC	230 V AC	⊕ B	<b>3SE5 212-3LC05</b>	1	1 unit
 With M12 socket and 2 LEDs	<b>With M12 connector socket, 5-pole (125 V, 4 A) and 2 LEDs</b>						
	Slow-action contacts	1 NO + 1 NC	24 V DC	⊕ B	<b>3SE5 214-1BC05-1AF3</b>	1	1 unit
	Snap-action contacts	1 NO + 1 NC	24 V DC	⊕ B	<b>3SE5 214-1CC05-1AF3</b>	1	1 unit

⚙️ For online configurator see [www.siemens.com/sirius/configurators](http://www.siemens.com/sirius/configurators).

⊕ Positive opening according to IEC 60947-5-1, Appendix K, or positively driven actuator, necessary in safety circuits.

<sup>1)</sup> For enclosures with widths of 31mm, the basic switch is a complete unit with rounded plungers.



<sup>2)</sup> Use corresponding high-grade steel lever.

Note:

Selection aid see page 13/9.

Version	Diameter	DT	Modular system	☒	PU (UNIT, SET, M)	PS*
	mm		Order No.	Price per PU		

### Operating mechanisms









 Plain plunger	<b>Plain plungers</b>						
	High-grade steel plungers	10	⊕ A	<b>3SE5 000-0AB01</b>	1	1 unit	
 Roller plunger	<b>Roller plungers, type C acc. to EN 50047</b>						
	Plastic rollers	10	⊕ A	<b>3SE5 000-0AD03</b>	1	1 unit	
	High-grade steel rollers	10	⊕ B	<b>3SE5 000-0AD04</b>	1	1 unit	

⊕ Positively driven actuator, necessary in safety circuits.

# Limit Switches

## SIRIUS 3SE5 International Limit Switches

3SE5, metal enclosures  
Enclosure width 31 mm acc. to EN 50047

Version	Diameter	DT	Modular system	Price per PU	PU (UNIT, SET, M)	PS*
	mm		Order No.			
<b>Operating mechanisms</b>						
	<b>Roller plungers with central fixing</b>					
	Plastic rollers	10	⊕ B	<b>3SE5 000-0AD10</b>	1	1 unit
	High-grade steel rollers	10	⊕ B	<b>3SE5 000-0AD11</b>	1	1 unit
With central fixing						
	<b>Roller levers, type E acc. to EN 50047</b>					
	Metal lever, plastic roller	13	⊕ A	<b>3SE5 000-0AE10</b>	1	1 unit
	Metal lever, high-grade steel roller	13	⊕ B	<b>3SE5 000-0AE11</b>	1	1 unit
	High-grade steel lever, plastic roller	13	⊕ B	<b>3SE5 000-0AE12</b>	1	1 unit
	High-grade steel lever, high-grade steel roller	13	⊕ B	<b>3SE5 000-0AE13</b>	1	1 unit
Roller lever						
	<b>Angular roller levers</b>					
	Metal lever, plastic roller	13	⊕ A	<b>3SE5 000-0AF10</b>	1	1 unit
	Metal lever, high-grade steel roller	13	⊕ B	<b>3SE5 000-0AF11</b>	1	1 unit
	High-grade steel lever, plastic roller	13	⊕ A	<b>3SE5 000-0AF12</b>	1	1 unit
	High-grade steel lever, high-grade steel roller	13	⊕ B	<b>3SE5 000-0AF13</b>	1	1 unit
Angular roller lever						
	<b>Spring rods (for switches with snap-action contacts only)</b>					
	Plastic plunger and high-grade steel spring:					
	• Length 142.5 mm (spring 50 mm, plunger 50 mm)	7	B	<b>3SE5 000-0AR01</b>	1	1 unit
	• Length 76 mm (spring 23.5 mm, plunger 10 mm)		B	<b>3SE5 000-0AR03</b>	1	1 unit
	• Length 242.5 mm (spring 150 mm, plunger 50 mm)		B	<b>3SE5 000-0AR04</b>	1	1 unit
	High-grade steel plunger and spring:	7				
• Length 142.5 mm (spring 50 mm, plunger 50 mm)		B	<b>3SE5 000-0AR02</b>	1	1 unit	
Spring rod						
<b>Twist actuators</b>						
	<b>Twist actuators, plastic (without lever)</b>					
	Switching right and/or left, adjustable		⊕ A	<b>3SE5 000-0AK00</b>	1	1 unit
Twist actuator						
	<b>Levers for twist actuators</b>					
	<b>Twist levers, straight, type A acc. to EN 50047</b>					
	Metal lever 21 mm, plastic roller	19	⊕ A	<b>3SE5 000-0AA21</b>	1	1 unit
	Metal lever 21 mm, high-grade steel roller	19	⊕ B	<b>3SE5 000-0AA22</b>	1	1 unit
	Metal lever 21 mm, roller with ball bearing	19	⊕ B	<b>3SE5 000-0AA23</b>	1	1 unit
	Metal lever 21 mm, plastic roller	30	⊕ B	<b>3SE5 000-0AA25</b>	1	1 unit
	High-grade steel lever 21 mm, plastic roller	19	⊕ B	<b>3SE5 000-0AA31</b>	1	1 unit
	High-grade steel lever 21 mm, high-grade steel roller	19	⊕ B	<b>3SE5 000-0AA32</b>	1	1 unit
	<b>Twist levers 30 mm, straight<sup>1)</sup></b>					
	Metal lever, plastic roller	19	⊕ B	<b>3SE5 000-0AA24</b>	1	1 unit
Metal lever, plastic roller	30	⊕ B	<b>3SE5 000-0AA26</b>	1	1 unit	
Twist levers						
	<b>Twist levers, adjustable length, with grid hole</b>					
	Metal lever, plastic roller	19	⊕ B	<b>3SE5 000-0AA60</b>	1	1 unit
	Metal lever, high-grade steel roller	19	⊕ B	<b>3SE5 000-0AA61</b>	1	1 unit
	Metal lever, plastic roller	50	⊕ B	<b>3SE5 000-0AA67</b>	1	1 unit
	Metal lever, rubber roller	50	⊕ B	<b>3SE5 000-0AA68</b>	1	1 unit
	High-grade steel lever, plastic roller	19	⊕ B	<b>3SE5 000-0AA62</b>	1	1 unit
	High-grade steel lever, high-grade steel roller	19	⊕ B	<b>3SE5 000-0AA63</b>	1	1 unit
	<b>Twist levers, adjustable length</b>					
Metal lever, plastic roller	19	A	<b>3SE5 000-0AA50</b>	1	1 unit	
Metal lever, high-grade steel roller	19	B	<b>3SE5 000-0AA51</b>	1	1 unit	
Metal lever, plastic roller	30	B	<b>3SE5 000-0AA55</b>	1	1 unit	
Metal lever, plastic roller	50	B	<b>3SE5 000-0AA57</b>	1	1 unit	
Metal lever, rubber roller	50	B	<b>3SE5 000-0AA58</b>	1	1 unit	
High-grade steel lever, plastic roller	19	B	<b>3SE5 000-0AA52</b>	1	1 unit	
High-grade steel lever, high-grade steel roller	19	B	<b>3SE5 000-0AA53</b>	1	1 unit	
Twist lever, adjustable length						
	<b>Rod actuators, type D acc. to EN 50041</b>					
	Aluminum rod, length 200 mm	6	B	<b>3SE5 000-0AA80</b>	1	1 unit
	Spring rod, length 200 mm	6	B	<b>3SE5 000-0AA81</b>	1	1 unit
	Plastic rod, length 200 mm	6	B	<b>3SE5 000-0AA82</b>	1	1 unit
	Plastic rod, length 330 mm	6	B	<b>3SE5 000-0AA83</b>	1	1 unit
Rod actuator						

⊕ Positively driven actuator, necessary in safety circuits.

<sup>1)</sup> Can be clinch mounted (turned through 180°, rear of lever).

# Limit Switches

## SIRIUS 3SE5 International Limit Switches

3SE5, metal enclosures  
Enclosure width 40 mm acc. to EN 50041

1  
2  
3  
4  
5  
6  
7  
8  
9  
10  
11  
12  
13







### Selection and ordering data

#### Complete units

2 or 3 contacts · Degree of protection IP66/IP67 · Cable entry M20 × 1.5

Version	Contacts	LEDs	DT	Complete units	<input type="checkbox"/>	PU (UNIT, SET, M)	PS*
				<b>Configurator</b>			
				Order No.		Price per PU	

#### Complete units<sup>1)</sup> · Enclosure width 40 mm

	<b>Plain plungers</b>						
	<b>With high-grade steel plunger</b>						
	Slow-action contacts	1 NO + 1 NC	—	⊕ A	<b>3SE5 112-0BB01</b>	1	1 unit
	Snap-action contacts	1 NO + 1 NC	—	⊕ A	<b>3SE5 112-0CB01</b>	1	1 unit
	Slow-action contacts	1 NO + 2 NC	—	⊕ ▶	<b>3SE5 112-0KB01</b>	1	1 unit
	Snap-action contacts	1 NO + 2 NC	—	⊕ B	<b>3SE5 112-0LB01</b>	1	1 unit
	<b>Rounded plungers, type B acc. to EN 50041</b>						
	<b>With high-grade steel plungers, with 3 mm overtravel</b>						
	Slow-action contacts	1 NO + 1 NC	—	⊕ ▶	<b>3SE5 112-0BC02</b>	1	1 unit
	Snap-action contacts	1 NO + 1 NC	—	⊕ ▶	<b>3SE5 112-0CC02</b>	1	1 unit
	Slow-action contacts	1 NO + 2 NC	—	⊕ B	<b>3SE5 112-0KC02</b>	1	1 unit
	Snap-action contacts	1 NO + 2 NC	—	⊕ B	<b>3SE5 112-0LC02</b>	1	1 unit
	<b>Roller plungers, type C acc. to EN 50041</b>						
	<b>With high-grade steel roller 13 mm, with 3 mm overtravel</b>						
	Slow-action contacts	1 NO + 1 NC	—	⊕ ▶	<b>3SE5 112-0BD02</b>	1	1 unit
	Snap-action contacts	1 NO + 1 NC	—	⊕ ▶	<b>3SE5 112-0CD02</b>	1	1 unit
	Slow-action contacts	1 NO + 2 NC	—	⊕ ▶	<b>3SE5 112-0KD02</b>	1	1 unit
	Snap-action contacts	1 NO + 2 NC	—	⊕ ▶	<b>3SE5 112-0LD02</b>	1	1 unit
	<b>With M12 connector socket, 5-pole (125 V, 4 A) and 2 LEDs</b>						
	Snap-action contacts	1 NO + 1 NC	24 V DC	⊕ B	<b>3SE5 114-1CD02-1AF3</b>	1	1 unit
	<b>Roller levers</b>						
	<b>With metal lever and plastic roller 22 mm</b>						
	Slow-action contacts	1 NO + 1 NC	—	⊕ ▶	<b>3SE5 112-0BE01</b>	1	1 unit
	Snap-action contacts	1 NO + 1 NC	—	⊕ ▶	<b>3SE5 112-0CE01</b>	1	1 unit
	Slow-action contacts	1 NO + 2 NC	—	⊕ B	<b>3SE5 112-0KE01</b>	1	1 unit
	Snap-action contacts	1 NO + 2 NC	—	⊕ B	<b>3SE5 112-0LE01</b>	1	1 unit
	<b>Angular roller levers</b>						
	<b>With metal lever and plastic roller 22 mm</b>						
	Slow-action contacts	1 NO + 1 NC	—	⊕ B	<b>3SE5 112-0BF01</b>	1	1 unit
	Snap-action contacts	1 NO + 1 NC	—	⊕ ▶	<b>3SE5 112-0CF01</b>	1	1 unit
	Snap-action contacts	1 NO + 2 NC	—	⊕ B	<b>3SE5 112-0LF01</b>	1	1 unit
	<b>Spring rods</b>						
	<b>Length 142.5 mm, with plastic plunger 50 mm</b>						
	Snap-action contacts	1 NO + 1 NC	—	▶	<b>3SE5 112-0CR01</b>	1	1 unit

For online configurator see [www.siemens.com/sirius/configurators](http://www.siemens.com/sirius/configurators).

⊕ Positive opening according to IEC 60947-5-1, Appendix K.

<sup>1)</sup> Popular versions.

# Limit Switches

## SIRIUS 3SE5 International Limit Switches

**3SE5, metal enclosures**  
**Enclosure width 40 mm acc. to EN 50041**

2 or 3 contacts · Degree of protection IP66/IP67 · Cable entry M20 × 1.5

Version	Contacts	LEDs	DT	Complete units	<input type="checkbox"/>	PU (UNIT, SET, M)	PS*
				<b>Configurator</b>			
				Order No.	Price per PU		

### Complete units<sup>1)</sup> · Enclosure width 40 mm



Twist lever

#### Twist levers, type A acc. to EN 50041

##### With metal lever 27 mm and plastic roller 19 mm

Slow-action contacts	1 NO + 1 NC	—	⊕ ▶	<b>3SE5 112-0BH01</b>		1	1 unit
Snap-action contacts	1 NO + 1 NC	—	⊕ ▶	<b>3SE5 112-0CH01</b>		1	1 unit
Slow-action contacts	1 NO + 2 NC	—	⊕ ▶	<b>3SE5 112-0KH01</b>		1	1 unit
Snap-action contacts	1 NO + 2 NC	—	⊕ B	<b>3SE5 112-0LH01</b>		1	1 unit

##### With M12 connector socket, 5-pole (125 V, 4 A)

Snap-action contacts	1 NO + 1 NC	—	⊕ A	<b>3SE5 114-0CH01-1AC5</b>		1	1 unit
----------------------	-------------	---	-----	----------------------------	--	---	--------

##### With M12 connector socket, 5-pole (125 V, 4 A) and 2 LEDs

Snap-action contacts	1 NO + 1 NC	24 V DC	⊕ B	<b>3SE5 114-1CH01-1AF3</b>		1	1 unit
----------------------	-------------	---------	-----	----------------------------	--	---	--------

##### With metal lever 27 mm and high-grade steel roller 19 mm

Slow-action contacts	1 NO + 1 NC	—	⊕ B	<b>3SE5 112-0BH02</b>		1	1 unit
Snap-action contacts	1 NO + 1 NC	—	⊕ ▶	<b>3SE5 112-0CH02</b>		1	1 unit

##### With M12 connector socket, 5-pole (125 V, 4 A) and 2 LEDs

Snap-action contacts	1 NO + 1 NC	—	⊕ B	<b>3SE5 114-1CH02-1AF3</b>		1	1 unit
----------------------	-------------	---	-----	----------------------------	--	---	--------

##### With metal lever 30 mm and plastic roller 19 mm

Snap-action contacts	1 NO + 1 NC	—	⊕ A	<b>3SE5 112-0CH24</b>		1	1 unit
----------------------	-------------	---	-----	-----------------------	--	---	--------

#### Twist levers, adjustable length

##### With metal lever with grid hole and plastic roller 19 mm

Slow-action contacts	1 NO + 1 NC	—	⊕ ▶	<b>3SE5 112-0BH60</b>		1	1 unit
Snap-action contacts	1 NO + 1 NC	—	⊕ ▶	<b>3SE5 112-0CH60</b>		1	1 unit
Snap-action contacts	1 NO + 2 NC	—	⊕ B	<b>3SE5 112-0LH60</b>		1	1 unit



Twist lever, adjustable length, with grid hole

##### With metal lever and plastic roller 19 mm

Slow-action contacts	1 NO + 1 NC	—	B	<b>3SE5 112-0BH50</b>		1	1 unit
Snap-action contacts	1 NO + 1 NC	—	▶	<b>3SE5 112-0CH50</b>		1	1 unit
Snap-action contacts	1 NO + 2 NC	—	B	<b>3SE5 112-0LH50</b>		1	1 unit



Twist lever, adjustable length

##### With M12 connector socket, 8-pole (30 V, 2 A) and 2 LEDs

Snap-action contacts	1 NO + 2 NC	24 V DC	B	<b>3SE5 114-1LH50-1AD4</b>		1	1 unit
----------------------	-------------	---------	---	----------------------------	--	---	--------

##### With metal lever and high-grade steel roller 19 mm

Snap-action contacts	1 NO + 1 NC	—	B	<b>3SE5 112-0CH51</b>		1	1 unit
----------------------	-------------	---	---	-----------------------	--	---	--------

#### Fork levers, latching

##### With metal lever and 2 plastic rollers 19 mm

Snap-action contacts	1 NO + 1 NC	—	⊕ B	<b>3SE5 112-0CT11</b>		1	1 unit
----------------------	-------------	---	-----	-----------------------	--	---	--------



Fork lever

#### Rod actuators, type D, acc. to EN 50041

##### With aluminum rod, length 200 mm

Snap-action contacts	1 NO + 1 NC	—	▶	<b>3SE5 112-0CH80</b>		1	1 unit
----------------------	-------------	---	---	-----------------------	--	---	--------

##### With plastic rod, length 200 mm

Snap-action contacts	1 NO + 1 NC	—	B	<b>3SE5 112-0CH82</b>		1	1 unit
----------------------	-------------	---	---	-----------------------	--	---	--------



Rod actuator

For online configurator see [www.siemens.com/sirius/configurators](http://www.siemens.com/sirius/configurators).

Positive opening according to IEC 60947-5-1, Appendix K.

<sup>1)</sup> Popular versions.

#### Note:

If the device you require is not available as a complete unit, see "Modular System", page 13/33.













# Limit Switches

## SIRIUS 3SE5 International Limit Switches

3SE5, metal enclosures  
Enclosure width 40 mm acc. to EN 50041

### Modular system

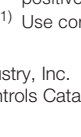
2 or 3 contacts · Degree of protection IP66/IP67 · Cable entry M20 × 1.5

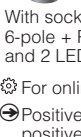
Version	Contacts	LEDs	DT	Modular system	PU (UNIT, SET, M)	PS*
				Configurator		
				Order No.	Price per PU	
<b>Basic switches · Enclosure width 40 mm</b>						
	<b>With M20 × 1.5 connecting thread</b>					
	Slow-action contacts	1 NO + 1 NC	—	⊕ ▶	<b>3SE5 112-0BA00</b>	1 1 unit
	Snap-action contacts	1 NO + 1 NC	—	⊕ ▶	<b>3SE5 112-0CA00</b>	1 1 unit
	• Gold-plated contacts			⊕ B	<b>3SE5 112-0CA00-1AC1</b>	1 1 unit
	Slow-action contacts	1 NO + 2 NC	—	⊕ A	<b>3SE5 112-0KA00</b>	1 1 unit
	Snap-action contacts	1 NO + 2 NC	—	⊕ ▶	<b>3SE5 112-0LA00</b>	1 1 unit
	Slow-action contacts with make-before-break	1 NO + 2 NC	—	⊕ ▶	<b>3SE5 112-0MA00</b>	1 1 unit
	Slow-action contacts	2 NO + 1 NC	—	⊕ ▶	<b>3SE5 112-0PA00</b>	1 1 unit
	<b>With increased corrosion protection<sup>1)</sup></b>					
	Slow-action contacts	1 NO + 1 NC	—	⊕ B	<b>3SE5 112-0BA00-1CA0</b>	1 1 unit
	Snap-action contacts	1 NO + 1 NC	—	⊕ B	<b>3SE5 112-0CA00-1CA0</b>	1 1 unit
	Slow-action contacts	1 NO + 2 NC	—	⊕ B	<b>3SE5 112-0KA00-1CA0</b>	1 1 unit
	Snap-action contacts	1 NO + 2 NC	—	⊕ B	<b>3SE5 112-0LA00-1CA0</b>	1 1 unit
	Slow-action contacts with make-before-break	1 NO + 2 NC	—	⊕ B	<b>3SE5 112-0MA00-1CA0</b>	1 1 unit
	Slow-action contacts	2 NO + 1 NC	—	⊕ B	<b>3SE5 112-0PA00-1CA0</b>	1 1 unit
	<b>With M12 connector socket, 5-pole (125 V, 4 A)</b>					
	Slow-action contacts	1 NO + 1 NC	—	⊕ B	<b>3SE5 114-0BA00-1AC5</b>	1 1 unit
	Snap-action contacts	1 NO + 1 NC	—	⊕ ▶	<b>3SE5 114-0CA00-1AC5</b>	1 1 unit
	Slow-action contacts	2 NC	—	⊕ B	<b>3SE5 114-0KA00-1AE1</b>	1 1 unit
	Snap-action contacts	2 NC	—	⊕ B	<b>3SE5 114-0LA00-1AE1</b>	1 1 unit
	<b>With connector socket, 6-pole + PE (250 V, 10 A)</b>					
	Slow-action contacts	1 NO + 2 NC	—	⊕ B	<b>3SE5 115-0KA00-1AD1</b>	1 1 unit
	Snap-action contacts	1 NO + 2 NC	—	⊕ ▶	<b>3SE5 115-0LA00-1AD1</b>	1 1 unit
	<b>With connector socket, 6-pole + PE (250 V, 10 A) and quick-release device</b>					
	Snap-action contacts	1 NO + 1 NC	—	⊕ B	<b>3SE5 115-0CA00-1AD0</b>	1 1 unit
	<b>With 2 LEDs, yellow/green</b>					
	Slow-action contacts	1 NO + 2 NC	24 V DC	⊕ B	<b>3SE5 112-1KA00</b>	1 1 unit
	Snap-action contacts	1 NO + 2 NC	24 V DC	⊕ ▶	<b>3SE5 112-1LA00</b>	1 1 unit
	Slow-action contacts	1 NO + 2 NC	230 V AC	⊕ B	<b>3SE5 112-3KA00</b>	1 1 unit
	Snap-action contacts	1 NO + 2 NC	230 V AC	⊕ B	<b>3SE5 112-3LA00</b>	1 1 unit
	<b>With M12 connector socket, 5-pole (125 V, 4 A) and 2 LEDs</b>					
	Slow-action contacts	1 NO + 1 NC	24 V DC	⊕ B	<b>3SE5 114-1BA00-1AF3</b>	1 1 unit
	Snap-action contacts	1 NO + 1 NC	24 V DC	⊕ B	<b>3SE5 114-1CA00-1AF3</b>	1 1 unit
	<b>With M12 connector socket, 8-pole (30 V, 2 A) and 2 LEDs</b>					
	Snap-action contacts	1 NO + 2 NC	24 V DC	⊕ B	<b>3SE5 114-1LA00-1AD4</b>	1 1 unit
	<b>With connector socket, 6-pole + PE (10 A), and 2 LEDs</b>					
	Slow-action contacts	1 NO + 1 NC	24 V DC	⊕ B	<b>3SE5 115-1BA00-1AF2</b>	1 1 unit
	Snap-action contacts	1 NO + 1 NC	24 V DC	⊕ B	<b>3SE5 115-1CA00-1AF2</b>	1 1 unit
	Snap-action contacts	2 NC	24 V DC	⊕ B	<b>3SE5 115-1LA00-1AD2</b>	1 1 unit

For online configurator see [www.siemens.com/sirius/configurators](http://www.siemens.com/sirius/configurators).

⊕ Positive opening according to IEC 60947-5-1, Appendix K, or positively driven actuator, necessary in safety circuits.

<sup>1)</sup> Use corresponding high-grade steel lever.





Note:

Selection aid, see page 13/9.

# Limit Switches

## SIRIUS 3SE5 International Limit Switches

3SE5, metal enclosures  
Enclosure width 40 mm acc. to EN 50041

Version	Diameter	DT	Modular system	Price per PU	PU (UNIT, SET, M)	PS*	
	mm		Order No.				
<b>Operating mechanisms</b>							
	<b>Plain plungers</b>						
	High-grade steel plungers	10	⊕ A	<b>3SE5 000-0AB01</b>	1	1 unit	
	<b>Rounded plungers, type B acc. to EN 50041</b>						
	High-grade steel plungers, with 3 mm overtravel	10	⊕ ▶	<b>3SE5 000-0AC02</b>	1	1 unit	
	<b>Roller plungers, type C acc. to EN 50041</b>						
	High-grade steel roller, with 3 mm overtravel	13	⊕ ▶	<b>3SE5 000-0AD02</b>	1	1 unit	
	<b>Roller levers</b>						
	Metal lever, plastic roller	22	⊕ ▶	<b>3SE5 000-0AE01</b>	1	1 unit	
	Metal lever, high-grade steel roller	22	⊕ ▶	<b>3SE5 000-0AE02</b>	1	1 unit	
	High-grade steel lever, plastic roller	22	⊕ B	<b>3SE5 000-0AE03</b>	1	1 unit	
	<b>Angular roller levers</b>						
	Metal lever, plastic roller	22	⊕ ▶	<b>3SE5 000-0AF01</b>	1	1 unit	
	Metal lever, high-grade steel roller	22	⊕ B	<b>3SE5 000-0AF02</b>	1	1 unit	
	High-grade steel lever, plastic roller	22	⊕ B	<b>3SE5 000-0AF03</b>	1	1 unit	
	<b>Spring rods (for switches with snap-action contacts only)</b>						
	Plastic plunger and high-grade steel spring:	7					
	• Length 142.5 mm (spring 50 mm, plunger 50 mm)		B	<b>3SE5 000-0AR01</b>	1	1 unit	
	• Length 76 mm (spring 23.5 mm, plunger 10 mm)		B	<b>3SE5 000-0AR03</b>	1	1 unit	
	<b>High-grade steel lever, high-grade steel roller</b>						
	High-grade steel plunger and spring:	7					
	• Length 242.5 mm (spring 150 mm, plunger 50 mm)		B	<b>3SE5 000-0AR04</b>	1	1 unit	
	• Length 142.5 mm (spring 50 mm, plunger 50 mm)		B	<b>3SE5 000-0AR02</b>	1	1 unit	
<b>Twist actuators</b>							
	<b>Twist actuators, metal (without lever)</b>						
	• For twist levers and rod actuators, switching right and/or left, adjustable		⊕ A	<b>3SE5 000-0AH00</b>	1	1 unit	
	<b>Lever for twist actuators</b>						
	• For fork levers, latching		⊕ ▶	<b>3SE5 000-0AT10</b>	1	1 unit	
	<b>Twist levers, offset, type A acc. to EN 50041</b>						
	Metal lever 27 mm, plastic roller	19	⊕ A	<b>3SE5 000-0AA01</b>	1	1 unit	
	Metal lever 27 mm, high-grade steel roller	19	⊕ A	<b>3SE5 000-0AA02</b>	1	1 unit	
	Metal lever 27 mm, roller with ball bearing	19	⊕ B	<b>3SE5 000-0AA03</b>	1	1 unit	
	Metal lever 27 mm, 2 plastic rollers	19	⊕ B	<b>3SE5 000-0AA04</b>	1	1 unit	
	Metal lever 27 mm, plastic roller	30	⊕ B	<b>3SE5 000-0AA05</b>	1	1 unit	
	Metal lever 27 mm, rubber roller	50	⊕ B	<b>3SE5 000-0AA08</b>	1	1 unit	
	High-grade steel lever 27 mm, plastic roller	19	⊕ B	<b>3SE5 000-0AA11</b>	1	1 unit	
	High-grade steel lever 27 mm, high-grade steel roller	19	⊕ B	<b>3SE5 000-0AA12</b>	1	1 unit	
	Metal lever 35 mm, plastic roller	19	⊕ B	<b>3SE5 000-0AA15</b>	1	1 unit	
	<b>Twist levers 30 mm, straight<sup>1)</sup></b>						
	Metal lever, plastic roller	19	⊕ B	<b>3SE5 000-0AA24</b>	1	1 unit	
<b>Twist levers, adjustable length, with grid hole</b>							
Metal lever, plastic roller	19	⊕ B	<b>3SE5 000-0AA60</b>	1	1 unit		
Metal lever, high-grade steel roller	19	⊕ B	<b>3SE5 000-0AA61</b>	1	1 unit		
Metal lever, rubber roller	50	⊕ B	<b>3SE5 000-0AA68</b>	1	1 unit		
High-grade steel lever, plastic roller	19	⊕ B	<b>3SE5 000-0AA62</b>	1	1 unit		
High-grade steel lever, high-grade steel roller	19	⊕ B	<b>3SE5 000-0AA63</b>	1	1 unit		
<b>Twist levers, adjustable length</b>							
Metal lever, plastic roller	19	A	<b>3SE5 000-0AA50</b>	1	1 unit		
Metal lever, high-grade steel roller	19	B	<b>3SE5 000-0AA51</b>	1	1 unit		
Metal lever, plastic roller	30	B	<b>3SE5 000-0AA55</b>	1	1 unit		
Metal lever, rubber roller	50	B	<b>3SE5 000-0AA58</b>	1	1 unit		
High-grade steel lever, plastic roller	19	B	<b>3SE5 000-0AA52</b>	1	1 unit		
High-grade steel lever, high-grade steel roller	19	B	<b>3SE5 000-0AA53</b>	1	1 unit		
<b>Fork levers (for switches with snap-action contacts only)</b>							
2 metal levers, 2 plastic rollers	19	⊕ ▶	<b>3SE5 000-0AT01</b>	1	1 unit		
2 metal levers, 2 high-grade steel rollers	19	⊕ B	<b>3SE5 000-0AT02</b>	1	1 unit		
2 high-grade steel levers, 2 plastic rollers	19	⊕ B	<b>3SE5 000-0AT03</b>	1	1 unit		
<b>Rod actuators, type D acc. to EN 50041</b>							
Aluminum rod, length 200 mm	6	B	<b>3SE5 000-0AA80</b>	1	1 unit		
Spring rod, length 200 mm	6	B	<b>3SE5 000-0AA81</b>	1	1 unit		
Plastic rod, length 200 mm	6	B	<b>3SE5 000-0AA82</b>	1	1 unit		

⊕ Positively driven actuator, necessary in safety circuits.

<sup>1)</sup> Can be clinch mounted (turned through 180°, rear of lever).

# Limit Switches

## SIRIUS 3SE5 International Limit Switches

3SE5, metal enclosures  
Enclosure width 56 mm

1  
2  
3  
4  
5  
6  
7  
8  
9  
10  
11  
12  
13

### Selection and ordering data

#### Complete units

2 or 3 contacts · Degree of protection IP66/IP67 · Cable entry 3 × (M20 × 1.5)

Version	Contacts	LEDs	DT	Complete units	<input type="checkbox"/>	PU (UNIT, SET, M)	PS*
				<b>Configurator</b>			
				Order No.		Price per PU	

#### Complete units<sup>1)</sup> · Enclosure width 56 mm



Plain plunger

#### Plain plungers

##### With high-grade steel plunger

Slow-action contacts	1 NO + 1 NC	—	⊕ B	<b>3SE5 122-0BB01</b>		1	1 unit
Snap-action contacts	1 NO + 1 NC	—	⊕ B	<b>3SE5 122-0CB01</b>		1	1 unit
Slow-action contacts	1 NO + 2 NC	—	⊕ B	<b>3SE5 122-0KB01</b>		1	1 unit
Snap-action contacts	1 NO + 2 NC	—	⊕ B	<b>3SE5 122-0LB01</b>		1	1 unit
Slow-action contacts	2 NO + 1 NC	—	⊕ B	<b>3SE5 122-0PB01</b>		1	1 unit



Rounded plunger

#### Rounded plungers

##### With high-grade steel plungers, with 3 mm overtravel

Slow-action contacts	1 NO + 1 NC	—	⊕ B	<b>3SE5 122-0BC02</b>		1	1 unit
Snap-action contacts	1 NO + 1 NC	—	⊕ ▶	<b>3SE5 122-0CC02</b>		1	1 unit
Slow-action contacts	1 NO + 2 NC	—	⊕ B	<b>3SE5 122-0KC02</b>		1	1 unit
Snap-action contacts	1 NO + 2 NC	—	⊕ B	<b>3SE5 122-0LC02</b>		1	1 unit
Slow-action contacts	2 NO + 1 NC	—	⊕ B	<b>3SE5 122-0PC02</b>		1	1 unit



Roller plunger

#### Roller plungers

##### With high-grade steel roller 13 mm, with 3 mm overtravel

Slow-action contacts	1 NO + 1 NC	—	⊕ ▶	<b>3SE5 122-0BD02</b>		1	1 unit
Snap-action contacts	1 NO + 1 NC	—	⊕ ▶	<b>3SE5 122-0CD02</b>		1	1 unit
Slow-action contacts	1 NO + 2 NC	—	⊕ ▶	<b>3SE5 122-0KD02</b>		1	1 unit
Snap-action contacts	1 NO + 2 NC	—	⊕ B	<b>3SE5 122-0LD02</b>		1	1 unit



Roller lever

#### Roller levers

##### With metal lever and plastic roller 22 mm

Slow-action contacts	1 NO + 1 NC	—	⊕ ▶	<b>3SE5 122-0BE01</b>		1	1 unit
Snap-action contacts	1 NO + 1 NC	—	⊕ ▶	<b>3SE5 122-0CE01</b>		1	1 unit
Slow-action contacts	1 NO + 2 NC	—	⊕ ▶	<b>3SE5 122-0KE01</b>		1	1 unit
Snap-action contacts	1 NO + 2 NC	—	⊕ B	<b>3SE5 122-0LE01</b>		1	1 unit
Slow-action contacts	2 NO + 1 NC	—	⊕ B	<b>3SE5 122-0PE01</b>		1	1 unit

##### With metal lever and high-grade steel roller 22 mm

Snap-action contacts	1 NO + 1 NC	—	⊕ B	<b>3SE5 122-0CE02</b>		1	1 unit
----------------------	-------------	---	-----	-----------------------	--	---	--------



Angular roller lever

#### Angular roller levers

##### With metal lever and plastic roller 22 mm

Slow-action contacts	1 NO + 1 NC	—	⊕ B	<b>3SE5 122-0BF01</b>		1	1 unit
Snap-action contacts	1 NO + 1 NC	—	⊕ ▶	<b>3SE5 122-0CF01</b>		1	1 unit
Slow-action contacts	2 NO + 1 NC	—	⊕ B	<b>3SE5 122-0PF01</b>		1	1 unit

For online configurator see [www.siemens.com/sirius/configurators](http://www.siemens.com/sirius/configurators).

⊕ Positive opening according to IEC 60947-5-1, Appendix K.

<sup>1)</sup> Popular versions.

# Limit Switches

## SIRIUS 3SE5 International Limit Switches

3SE5, metal enclosures  
Enclosure width 56 mm

2 or 3 contacts · Degree of protection IP66/IP67 · Cable entry 3 × (M20 × 1.5)

Version	Contacts	LEDs	DT	Complete units	<input type="checkbox"/>	PU (UNIT, SET, M)	PS*
				<b>Configurator</b>			
				Order No.	Price per PU		

### Complete units<sup>1)</sup> · Enclosure width 56 mm



Spring rod

#### Spring rods

Length 142.5 mm, with plastic plunger 50 mm

Snap-action contacts

1 NO + 1 NC —



**3SE5 122-0CR01**

1

1 unit



Twist lever

#### Twist levers

With metal lever 27 mm and plastic roller 19 mm

Slow-action contacts

1 NO + 1 NC —



**3SE5 122-0BH01**

1

1 unit

Snap-action contacts

1 NO + 1 NC —



**3SE5 122-0CH01**

1

1 unit

Slow-action contacts

1 NO + 2 NC —



**3SE5 122-0KH01**

1

1 unit

Snap-action contacts

1 NO + 2 NC —



**3SE5 122-0LH01**

1

1 unit

Slow-action contacts

2 NO + 1 NC —



**3SE5 122-0PH01**

1

1 unit

With metal lever 27 mm and high-grade steel roller 19 mm

Snap-action contacts

1 NO + 1 NC —



**3SE5 122-0CH02**

1

1 unit

Snap-action contacts

1 NO + 2 NC —



**3SE5 122-0LH02**

1

1 unit



Twist lever, adjustable length

#### Twist levers, adjustable length

With metal lever with grid hole and plastic roller 19 mm

Slow-action contacts

1 NO + 1 NC —



**3SE5 122-0BH60**

1

1 unit

Snap-action contacts

1 NO + 1 NC —



**3SE5 122-0CH60**

1

1 unit

Snap-action contacts

1 NO + 2 NC —



**3SE5 122-0LH60**

1

1 unit

With metal lever and plastic roller 19 mm

Slow-action contacts

1 NO + 1 NC —

B

**3SE5 122-0BH50**

1

1 unit

Snap-action contacts

1 NO + 1 NC —



**3SE5 122-0CH50**

1

1 unit

Snap-action contacts

1 NO + 2 NC —

B

**3SE5 122-0LH50**

1

1 unit



Fork lever

#### Fork levers, latching

With metal lever and 2 plastic rollers 19 mm

Snap-action contacts

1 NO + 1 NC —



**3SE5 122-0CT11**

1

1 unit



Rod actuator

#### Rod actuators

With aluminum rod, length 200 mm

Snap-action contacts

1 NO + 1 NC —

B

**3SE5 122-0CH80**

1

1 unit

With plastic rod, length 200 mm

Snap-action contacts

1 NO + 1 NC —

B

**3SE5 122-0CH82**

1

1 unit

#### Note:

If the device you require is not available as a complete unit, see "Modular System", page 13/37.

For online configurator see [www.siemens.com/sirius/configurators](http://www.siemens.com/sirius/configurators).

Positive opening according to IEC 60947-5-1, Appendix K.

<sup>1)</sup> Popular versions.

# Limit Switches

## SIRIUS 3SE5 International Limit Switches

3SE5, metal enclosures  
Enclosure width 56 mm

### Modular system

2 or 3 contacts · Degree of protection IP66/IP67 · Cable entry 3 × (M20 × 1.5)

Version	Contacts	LEDs	DT	Modular system	PU (UNIT, SET, M)	PS*
				Order No.	Price per PU	

### Basic switches · Enclosure width 56 mm

Version	Contacts	LEDs	DT	Modular system	PU (UNIT, SET, M)	PS*
<b>With 3 x M20 x 1.5 connecting thread</b>						
	Slow-action contacts	1 NO + 1 NC	—	➔ ▶ 3SE5 122-0BA00	1	1 unit
	Snap-action contacts	1 NO + 1 NC	—	➔ ▶ 3SE5 122-0CA00	1	1 unit
	Slow-action contacts	1 NO + 2 NC	—	➔ B 3SE5 122-0KA00	1	1 unit
	Snap-action contacts	1 NO + 2 NC	—	➔ A 3SE5 122-0LA00	1	1 unit
	Slow-action contacts with make-before-break	1 NO + 2 NC	—	➔ A 3SE5 122-0MA00	1	1 unit
	Slow-action contacts	2 NO + 1 NC	—	➔ ▶ 3SE5 122-0PA00	1	1 unit
<b>With increased corrosion protection<sup>1)</sup></b>						
	Slow-action contacts	1 NO + 1 NC	—	➔ B 3SE5 122-0BA00-1CA0	1	1 unit
	Snap-action contacts	1 NO + 1 NC	—	➔ B 3SE5 122-0CA00-1CA0	1	1 unit
	Slow-action contacts	1 NO + 2 NC	—	➔ B 3SE5 122-0KA00-1CA0	1	1 unit
	Snap-action contacts	1 NO + 2 NC	—	➔ B 3SE5 122-0LA00-1CA0	1	1 unit
	Slow-action contacts with make-before-break	1 NO + 2 NC	—	➔ B 3SE5 122-0MA00-1CA0	1	1 unit
	Slow-action contacts	2 NO + 1 NC	—	➔ B 3SE5 122-0PA00-1CA0	1	1 unit
<b>With 2 LEDs, yellow/green</b>						
	Slow-action contacts	1 NO + 2 NC	24 V DC	➔ B 3SE5 122-1KA00	1	1 unit
	Snap-action contacts	1 NO + 2 NC	24 V DC	➔ B 3SE5 122-1LA00	1	1 unit
	Slow-action contacts	1 NO + 2 NC	230 V AC	➔ B 3SE5 122-3KA00	1	1 unit
	Snap-action contacts	1 NO + 2 NC	230 V AC	➔ B 3SE5 122-3LA00	1	1 unit

For online configurator see [www.siemens.com/sirius/configurators](http://www.siemens.com/sirius/configurators).

Positive opening according to IEC 60947-5-1, Appendix K, or positively driven actuator, necessary in safety circuits.

<sup>1)</sup> Use corresponding high-grade steel lever.

Note:

Selection aid see page 13/9.

Version	Diameter	DT	Modular system	PU (UNIT, SET, M)	PS*
	mm				
			Order No.	Price per PU	





### Operating mechanisms

Version	Diameter	DT	Modular system	PU (UNIT, SET, M)	PS*
<b>Plain plungers</b>					
	High-grade steel plungers	10	➔ A 3SE5 000-0AB01	1	1 unit
	<b>Rounded plungers, type B acc. to EN 50041</b>				
	High-grade steel plungers, with 3 mm overtravel	10	➔ B 3SE5 000-0AC02	1	1 unit
	<b>Roller plungers, type C acc. to EN 50041</b>				
	High-grade steel roller, with 3 mm overtravel	13	➔ B 3SE5 000-0AD02	1	1 unit
	<b>Roller levers</b>				
	Metal lever, plastic roller	22	➔ A 3SE5 000-0AE01	1	1 unit
	Metal lever, high-grade steel roller	22	➔ B 3SE5 000-0AE02	1	1 unit
	High-grade steel lever, plastic roller	22	➔ B 3SE5 000-0AE03	1	1 unit
	High-grade steel lever, high-grade steel roller	22	➔ B 3SE5 000-0AE04	1	1 unit
<b>Angular roller levers</b>					
	Metal lever, plastic roller	22	➔ A 3SE5 000-0AF01	1	1 unit
	Metal lever, high-grade steel roller	22	➔ B 3SE5 000-0AF02	1	1 unit
	High-grade steel lever, plastic roller	22	➔ B 3SE5 000-0AF03	1	1 unit
	High-grade steel lever, high-grade steel roller	22	➔ B 3SE5 000-0AF04	1	1 unit
<b>Spring rods (for switches with snap-action contacts only)</b>					
	Plastic plunger and high-grade steel spring:	7			
	• Length 142.5 mm (spring 50 mm, plunger 50 mm)		B 3SE5 000-0AR01	1	1 unit
	• Length 76 mm (spring 23.5 mm, plunger 10 mm)		B 3SE5 000-0AR03	1	1 unit
	• Length 242.5 mm (spring 150 mm, plunger 50 mm)		B 3SE5 000-0AR04	1	1 unit
	High-grade steel plunger and spring:	7			
	• Length 142.5 mm (spring 50 mm, plunger 50 mm)		B 3SE5 000-0AR02	1	1 unit

# Limit Switches

## SIRIUS 3SE5 International Limit Switches

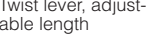
3SE5, metal enclosures  
Enclosure width 56 mm

Version	Diameter	DT	Modular system	PU (UNIT, SET, M)	PS*	
	mm		Order No.	Price per PU		
<b>Twist actuators</b>						
	<b>Twist actuators, metal (without lever)</b>					
	<ul style="list-style-type: none"> <li>For twist levers and rod actuators, switching right and/or left, adjustable</li> <li>For fork levers, latching</li> </ul>	<ul style="list-style-type: none"> <li>⊕ A</li> <li>⊕ B</li> </ul>	<ul style="list-style-type: none"> <li><b>3SE5 000-0AH00</b></li> <li><b>3SE5 000-0AT10</b></li> </ul>	<ul style="list-style-type: none"> <li>1</li> <li>1</li> </ul>	<ul style="list-style-type: none"> <li>1 unit</li> <li>1 unit</li> </ul>	
<b>Levers for twist actuators</b>						
	<b>Twist levers 27 mm, offset, type A acc. to EN 50041</b>					
	Metal lever, plastic roller	19	⊕ A	<b>3SE5 000-0AA01</b>	1	1 unit
	Metal lever, high-grade steel roller	19	⊕ A	<b>3SE5 000-0AA02</b>	1	1 unit
	Metal lever, roller with ball bearing	19	⊕ B	<b>3SE5 000-0AA03</b>	1	1 unit
	Metal lever, 2 plastic rollers	19	⊕ B	<b>3SE5 000-0AA04</b>	1	1 unit
	Metal lever, plastic roller	30	⊕ B	<b>3SE5 000-0AA05</b>	1	1 unit
	Metal lever, plastic roller	50	⊕ B	<b>3SE5 000-0AA07</b>	1	1 unit
	Metal lever, rubber roller	50	⊕ B	<b>3SE5 000-0AA08</b>	1	1 unit
	High-grade steel lever, plastic roller	19	⊕ B	<b>3SE5 000-0AA11</b>	1	1 unit
	High-grade steel lever, high-grade steel roller	19	⊕ B	<b>3SE5 000-0AA12</b>	1	1 unit
	<b>Twist levers 35 mm, offset</b>					
	Metal lever, plastic roller	19	⊕ B	<b>3SE5 000-0AA15</b>	1	1 unit
	<b>Twist levers 30 mm, straight<sup>1)</sup></b>					
	Metal lever, plastic roller	19	⊕ B	<b>3SE5 000-0AA24</b>	1	1 unit
	Metal lever, plastic roller	30	⊕ B	<b>3SE5 000-0AA26</b>	1	1 unit
	<b>Twist levers, adjustable length, with grid hole</b>					
	Metal lever, plastic roller	19	⊕ B	<b>3SE5 000-0AA60</b>	1	1 unit
	Metal lever, high-grade steel roller	19	⊕ B	<b>3SE5 000-0AA61</b>	1	1 unit
	Metal lever, plastic roller	50	⊕ B	<b>3SE5 000-0AA67</b>	1	1 unit
	Metal lever, rubber roller	50	⊕ B	<b>3SE5 000-0AA68</b>	1	1 unit
	High-grade steel lever, plastic roller	19	⊕ B	<b>3SE5 000-0AA62</b>	1	1 unit
	High-grade steel lever, high-grade steel roller	19	⊕ B	<b>3SE5 000-0AA63</b>	1	1 unit
	<b>Twist levers, adjustable length</b>					
	Metal lever, plastic roller	19	A	<b>3SE5 000-0AA50</b>	1	1 unit
	Metal lever, high-grade steel roller	19	B	<b>3SE5 000-0AA51</b>	1	1 unit
	Metal lever, plastic roller	30	B	<b>3SE5 000-0AA55</b>	1	1 unit
	Metal lever, plastic roller	50	B	<b>3SE5 000-0AA57</b>	1	1 unit
	Metal lever, rubber roller	50	B	<b>3SE5 000-0AA58</b>	1	1 unit
	High-grade steel lever, plastic roller	19	B	<b>3SE5 000-0AA52</b>	1	1 unit
	High-grade steel lever, high-grade steel roller	19	B	<b>3SE5 000-0AA53</b>	1	1 unit
	<b>Fork levers (for switches with snap-action contacts only)</b>					
	2 metal levers, 2 plastic rollers	19	⊕ B	<b>3SE5 000-0AT01</b>	1	1 unit
	2 metal levers, 2 high-grade steel rollers	19	⊕ B	<b>3SE5 000-0AT02</b>	1	1 unit
	2 high-grade steel levers, 2 plastic rollers	19	⊕ B	<b>3SE5 000-0AT03</b>	1	1 unit
	2 high-grade steel levers, 2 high-grade steel rollers	19	⊕ B	<b>3SE5 000-0AT04</b>	1	1 unit
	<b>Rod actuators, type D acc. to EN 50041</b>					
	Aluminum rod, length 200 mm	6	B	<b>3SE5 000-0AA80</b>	1	1 unit
	Spring rod, length 200 mm	6	B	<b>3SE5 000-0AA81</b>	1	1 unit
	Plastic rod, length 200 mm	6	B	<b>3SE5 000-0AA82</b>	1	1 unit

⊕ Positively driven actuator, necessary in safety circuits.

<sup>1)</sup> Can be clinch mounted (turned through 180°, rear of lever).

# Limit Switches

## SIRIUS 3SE5 International Limit Switches

Metal enclosures  
Enclosure width 56 mm, XL

1  
2  
3  
4  
5  
6  
7  
8  
9  
10  
11  
12  
13

### Selection and ordering data

#### Complete units

4 or 5 contacts · Degree of protection IP66/IP67 · Cable entry 3 × (M20 × 1.5)

Version	Contacts	LEDs	DT	Complete units	PU (UNIT, SET, M)	PS*
				<input type="checkbox"/>		
						
				Order No.	Price per PU	

#### Complete units<sup>1)</sup> · Enclosure width 56 mm, XL



Plain plunger

#### Plain plungers

##### With high-grade steel plunger

Snap-action contacts 2 × (1 NO + 1 NC) —  B 3SE5 162-0CB01 1 1 unit



Rounded plunger

#### Rounded plungers

##### With high-grade steel plungers, with 3 mm overtravel

Slow-action contacts 1 NO + 1 NC and  B 3SE5 162-0EC02 1 1 unit  
 Slow-action contacts with make-before-break 1 NO + 2 NC  
 2 mm travel difference



Roller plunger

#### Roller plungers

##### With high-grade steel roller 13 mm, with 3 mm overtravel

Slow-action contacts 2 × (1 NO + 1 NC) —  B 3SE5 162-0BD02 1 1 unit  
 Snap-action contacts 2 × (1 NO + 1 NC) —  A 3SE5 162-0CD02 1 1 unit



Roller lever

#### Roller levers

##### With metal lever and plastic roller 22 mm

Slow-action contacts 2 × (1 NO + 1 NC) —  B 3SE5 162-0BE01 1 1 unit  
 Snap-action contacts 2 × (1 NO + 1 NC) —  A 3SE5 162-0CE01 1 1 unit

##### With metal lever and high-grade steel roller 22 mm

Snap-action contacts 2 × (1 NO + 1 NC) —  B 3SE5 162-0CE02 1 1 unit



Angular roller lever

#### Angular roller levers

##### With metal lever and plastic roller 22 mm

Snap-action contacts 2 × (1 NO + 1 NC) —  B 3SE5 162-0CF01 1 1 unit



Twist lever

#### Twist levers

##### With metal lever 27 mm and plastic roller 19 mm

Snap-action contacts 2 × (1 NO + 1 NC) —  A 3SE5 162-0CH01 1 1 unit

 For online configurator see [www.siemens.com/sirius/configurators](http://www.siemens.com/sirius/configurators).

 Positive opening according to IEC 60947-5-1, Appendix K.

<sup>1)</sup> Popular versions.

#### Note:

If the device you require is not available as a complete unit, see "Modular System", page 13/40.

# Limit Switches

## SIRIUS 3SE5 International Limit Switches

**Metal enclosures**  
Enclosure width 56 mm, XL

### Modular system

4 or 6 contacts · Degree of protection IP66/IP67 · Cable entry 3 × (M20 × 1.5)

Version	Contacts	LEDs	DT	Modular system	PU (UNIT, SET, M)	PS*
				Order No.	Price per PU	

### Basic switches · Enclosure width 56 mm, XL



Basic switch

With 3 x M20 x 1.5 connecting thread						
Slow-action contacts	2 × (1 NO + 1 NC)	—	⊕ ▶	<b>3SE5 162-0BA00</b>	1	1 unit
Snap-action contacts	2 × (1 NO + 1 NC)	—	⊕ A	<b>3SE5 162-0CA00</b>	1	1 unit
Slow-action contacts with make-before-break	2 × (1 NO + 2 NC)	—	⊕ A	<b>3SE5 162-0DA00</b>	1	1 unit
With increased corrosion protection <sup>1)</sup>						
Slow-action contacts	2 × (1 NO + 1 NC)	—	⊕ B	<b>3SE5 162-0BA00-1CA0</b>	1	1 unit
Snap-action contacts	2 × (1 NO + 1 NC)	—	⊕ B	<b>3SE5 162-0CA00-1CA0</b>	1	1 unit
Slow-action contacts with make-before-break	2 × (1 NO + 2 NC)	—	⊕ B	<b>3SE5 162-0DA00-1CA0</b>	1	1 unit

For online configurator see [www.siemens.com/sirius/configurators](http://www.siemens.com/sirius/configurators).

Positive opening according to IEC 60947-5-1, Appendix K, or positively driven actuator, necessary in safety circuits.

<sup>1)</sup> Use corresponding high-grade steel lever.

Note:

Selection aid [see page 13/9](#).

Version	Diameter	DT	Modular system	PU (UNIT, SET, M)	PS*
	mm				
			Order No.	Price per PU	

### Operating mechanisms



Plain plunger

Plain plungers						
High-grade steel plungers	10	⊕ A	<b>3SE5 000-0AB01</b>	1	1 unit	



Rounded plunger

Rounded plungers, type B acc. to EN 50041						
High-grade steel plungers, with 3 mm overtravel	10	⊕ B	<b>3SE5 000-0AC02</b>	1	1 unit	



Roller plunger

Roller plungers, type C acc. to EN 50041						
High-grade steel roller, with 3 mm overtravel	13	⊕ B	<b>3SE5 000-0AD02</b>	1	1 unit	



Roller lever

Roller levers						
Metal lever, plastic roller	22	⊕ A	<b>3SE5 000-0AE01</b>	1	1 unit	
Metal lever, high-grade steel roller	22	⊕ B	<b>3SE5 000-0AE02</b>	1	1 unit	
High-grade steel lever, plastic roller	22	⊕ B	<b>3SE5 000-0AE03</b>	1	1 unit	
High-grade steel lever, high-grade steel roller	22	⊕ B	<b>3SE5 000-0AE04</b>	1	1 unit	



Angular roller lever

Angular roller levers						
Metal lever, plastic roller	22	⊕ A	<b>3SE5 000-0AF01</b>	1	1 unit	
Metal lever, high-grade steel roller	22	⊕ B	<b>3SE5 000-0AF02</b>	1	1 unit	
High-grade steel lever, plastic roller	22	⊕ B	<b>3SE5 000-0AF03</b>	1	1 unit	
High-grade steel lever, high-grade steel roller	22	⊕ B	<b>3SE5 000-0AF04</b>	1	1 unit	



Spring rod

Spring rods (for switches with snap-action contacts only)						
Plastic plunger and high-grade steel spring:	7					
• Length 142.5 mm (spring 50 mm, plunger 50 mm)		B	<b>3SE5 000-0AR01</b>	1	1 unit	
• Length 76 mm (spring 23.5 mm, plunger 10 mm)		B	<b>3SE5 000-0AR03</b>	1	1 unit	
• Length 242.5 mm (spring 150 mm, plunger 50 mm)		B	<b>3SE5 000-0AR04</b>	1	1 unit	
High-grade steel plunger and spring:	7					
• Length 142.5 mm (spring 50 mm, plunger 50 mm)		B	<b>3SE5 000-0AR02</b>	1	1 unit	

Positively driven actuator, necessary in safety circuits.







# Limit Switches

## SIRIUS 3SE5 International Limit Switches

**Metal enclosures**  
Enclosure width 56mm and 56mm, XL

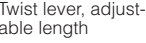
1  
2  
3  
4  
5  
6  
7  
8  
9  
10  
11  
12  
13

Version	Diameter	DT	Modular system	PU (UNIT, SET, M)	PS*	
	mm		Order No.	Price per PU		
<b>Twist actuators</b>						
	<b>Twist actuators, metal (without lever)</b>					
	<ul style="list-style-type: none"> <li>For twist levers and rod actuators, switching right and/or left, adjustable</li> <li>For fork levers, latching</li> </ul>	<ul style="list-style-type: none"> <li>⊕ A</li> <li>⊕ B</li> </ul>	<ul style="list-style-type: none"> <li><b>3SE5 000-0AH00</b></li> <li><b>3SE5 000-0AT10</b></li> </ul>	<ul style="list-style-type: none"> <li>1</li> <li>1</li> </ul>	<ul style="list-style-type: none"> <li>1 unit</li> <li>1 unit</li> </ul>	
<b>Levers for twist actuators</b>						
	<b>Twist levers 27 mm, offset, type A acc. to EN 50041</b>					
	Metal lever, plastic roller	19	⊕ A	<b>3SE5 000-0AA01</b>	1	1 unit
	Metal lever, high-grade steel roller	19	⊕ A	<b>3SE5 000-0AA02</b>	1	1 unit
	Metal lever, roller with ball bearing	19	⊕ B	<b>3SE5 000-0AA03</b>	1	1 unit
	Metal lever, 2 plastic rollers	19	⊕ B	<b>3SE5 000-0AA04</b>	1	1 unit
	Metal lever, plastic roller	30	⊕ B	<b>3SE5 000-0AA05</b>	1	1 unit
	Metal lever, plastic roller	50	⊕ B	<b>3SE5 000-0AA07</b>	1	1 unit
	Metal lever, rubber roller	50	⊕ B	<b>3SE5 000-0AA08</b>	1	1 unit
	High-grade steel lever, plastic roller	19	⊕ B	<b>3SE5 000-0AA11</b>	1	1 unit
	High-grade steel lever, high-grade steel roller	19	⊕ B	<b>3SE5 000-0AA12</b>	1	1 unit
	<b>Twist levers 35 mm, offset</b>					
	Metal lever, plastic roller	19	⊕ B	<b>3SE5 000-0AA15</b>	1	1 unit
	<b>Twist levers 30 mm, straight<sup>1)</sup></b>					
	Metal lever, plastic roller	19	⊕ B	<b>3SE5 000-0AA24</b>	1	1 unit
Metal lever, plastic roller	30	⊕ B	<b>3SE5 000-0AA26</b>	1	1 unit	
	<b>Twist levers, adjustable length, with grid hole</b>					
	Metal lever, plastic roller	19	⊕ B	<b>3SE5 000-0AA60</b>	1	1 unit
	Metal lever, high-grade steel roller	19	⊕ B	<b>3SE5 000-0AA61</b>	1	1 unit
	Metal lever, plastic roller	50	⊕ B	<b>3SE5 000-0AA67</b>	1	1 unit
	Metal lever, rubber roller	50	⊕ B	<b>3SE5 000-0AA68</b>	1	1 unit
	High-grade steel lever, plastic roller	19	⊕ B	<b>3SE5 000-0AA62</b>	1	1 unit
	High-grade steel lever, high-grade steel roller	19	⊕ B	<b>3SE5 000-0AA63</b>	1	1 unit
	<b>Twist levers, adjustable length</b>					
	Metal lever, plastic roller	19	A	<b>3SE5 000-0AA50</b>	1	1 unit
	Metal lever, high-grade steel roller	19	B	<b>3SE5 000-0AA51</b>	1	1 unit
	Metal lever, plastic roller	30	B	<b>3SE5 000-0AA55</b>	1	1 unit
	Metal lever, plastic roller	50	B	<b>3SE5 000-0AA57</b>	1	1 unit
	Metal lever, rubber roller	50	B	<b>3SE5 000-0AA58</b>	1	1 unit
	High-grade steel lever, plastic roller	19	B	<b>3SE5 000-0AA52</b>	1	1 unit
	High-grade steel lever, high-grade steel roller	19	B	<b>3SE5 000-0AA53</b>	1	1 unit
	<b>Fork levers (for switches with snap-action contacts only)</b>					
	2 metal levers, 2 plastic rollers	19	⊕ B	<b>3SE5 000-0AT01</b>	1	1 unit
	2 metal levers, 2 high-grade steel rollers	19	⊕ B	<b>3SE5 000-0AT02</b>	1	1 unit
	2 high-grade steel levers, 2 plastic rollers	19	⊕ B	<b>3SE5 000-0AT03</b>	1	1 unit
	2 high-grade steel levers, 2 high-grade steel rollers	19	⊕ B	<b>3SE5 000-0AT04</b>	1	1 unit
	<b>Rod actuators, type D acc. to EN 50041</b>					
	Aluminum rod, length 200 mm	6	B	<b>3SE5 000-0AA80</b>	1	1 unit
	Spring rod, length 200 mm	6	B	<b>3SE5 000-0AA81</b>	1	1 unit
	Plastic rod, length 200 mm	6	B	<b>3SE5 000-0AA82</b>	1	1 unit
	Plastic rod, length 330 mm	6	B	<b>3SE5 000-0AA83<sup>2)</sup></b>	1	1 unit

⊕ Positively driven actuator, necessary in safety circuits.

<sup>1)</sup> Can be clinch mounted (turned through 180°, rear of lever).

<sup>2)</sup> For Enclosure width 56mm XL only.



# Limit Switches

## SIRIUS 3SE5 International Limit Switches

3SE5, metal enclosures  
Ambient temperature to -40 °C

### Complete units

2 or 3 contacts · Degree of protection IP66/IP67 · Cable entry M20 × 1.5

Version	Contacts	LEDs	DT	Complete units	Configurator	Order No.	Price per PU	PU (UNIT, SET, M)	PS*

#### Complete units · Enclosure width 40 mm



Rounded plunger

##### Rounded plungers, type B acc. to EN 50041

With high-grade steel plungers, with 3 mm overtravel

Snap-action contacts	1 NO + 1 NC	—	⊕ B	3SE5 112-0CC02-1AJ0	1	1 unit
----------------------	-------------	---	-----	---------------------	---	--------



Twist lever, adjustable length

##### Twist levers, adjustable length

With high-grade steel lever with grid hole and plastic roller 19 mm

Snap-action contacts	1 NO + 1 NC	—	⊕ B	3SE5 112-0CH62-1AJ0	1	1 unit
----------------------	-------------	---	-----	---------------------	---	--------

For online configurator see [www.siemens.com/sirius/configurators](http://www.siemens.com/sirius/configurators).

⊕ Positive opening according to IEC 60947-5-1, Appendix K or positively driven actuator, necessary in safety circuits.

#### Note:

If the device you require is not available as a complete unit, see "Modular System".

### Modular system

2, 3 or 4 contacts · Degree of protection IP66/IP67 · Cable entry M20 × 1.5

Version	Contacts	LEDs	DT	Modular system	Configurator	Order No.	Price per PU	PU (UNIT, SET, M)	PS*

#### Basic switches · Enclosure width 40 mm



Basic switch

##### With M20 □ 1.5 connecting thread

Snap-action contacts	1 NO + 1 NC	—	⊕ B	3SE5 112-0CA00-1AJ0	1	1 unit
Slow-action contacts	1 NO + 2 NC	—	⊕ B	3SE5 112-0KA00-1AJ0	1	1 unit
Snap-action contacts	1 NO + 2 NC	—	⊕ B	3SE5 112-0LA00-1AJ0	1	1 unit

#### Basic switches · Enclosure width 56 mm



Basic switch

##### With 3 x M20 x 1.5 connecting thread

Snap-action contacts	1 NO + 1 NC	—	⊕ B	3SE5 122-0CA00-1AJ0	1	1 unit
Slow-action contacts	1 NO + 2 NC	—	⊕ B	3SE5 122-0KA00-1AJ0	1	1 unit
Snap-action contacts	1 NO + 2 NC	—	⊕ B	3SE5 122-0LA00-1AJ0	1	1 unit

#### Basic switches · Enclosure width 56 mm, XL



Basic switch

##### With 3 x M20 x 1.5 connecting thread

Slow-action contacts	2 × (1 NO + 1 NC)	—	⊕ B	3SE5 162-0BA00-1AJ0	1	1 unit
Snap-action contacts	2 × (1 NO + 1 NC)	—	⊕ B	3SE5 162-0CA00-1AJ0	1	1 unit

For online configurator see [www.siemens.com/sirius/configurators](http://www.siemens.com/sirius/configurators).

⊕ Positive opening according to IEC 60947-5-1, Appendix K or positively driven actuator, necessary in safety circuits.







#### Note:

Selection aid [see page 13/9](#).

# Limit Switches

## SIRIUS 3SE5 International Limit Switches

3SE5, metal enclosures  
Ambient temperature to -40 °C

Version	Diameter	DT	Modular system	PU (UNIT, SET, M)	PS*
	mm		Order No. Price per PU		
<b>Operating mechanisms</b>					
	<b>Rounded plungers, type B acc. to EN 50041</b> High-grade steel plungers, with 3 mm overtravel	10	⊕ B	<b>3SE5 000-0AC02-1AJ0</b>	1 1 unit
Rounded plunger					
	<b>Roller plungers, type C acc. to EN 50041</b> High-grade steel roller, with 3 mm overtravel	10	⊕ B	<b>3SE5 000-0AD02-1AJ0</b>	1 1 unit
Roller plunger					
<b>Roller levers</b>					
	Metal lever, plastic roller	13	⊕ B	<b>3SE5 000-0AE01-1AJ0</b>	1 1 unit
Roller lever	High-grade steel lever, plastic roller	13	⊕ B	<b>3SE5 000-0AE03-1AJ0</b>	1 1 unit
<b>Angular roller levers</b>					
	Metal lever, plastic roller	13	⊕ B	<b>3SE5 000-0AF01-1AJ0</b>	1 1 unit
Angular roller lever	High-grade steel lever, plastic roller	13	⊕ B	<b>3SE5 000-0AF03-1AJ0</b>	1 1 unit
<b>Twist actuators</b>					
	<b>Twist actuators, metal (without lever)</b> Switching right and/or left, adjustable		⊕ B	<b>3SE5 000-0AH00-1AJ0</b>	1 1 unit
Twist actuator					
<b>Levers for twist actuators</b>					
	<b>Twist levers, type A acc. to EN 50041</b> Metal lever, plastic roller	19	⊕ B	<b>3SE5 000-0AA01-1AJ0</b>	1 1 unit
Twist lever	High-grade steel lever, plastic roller	19	⊕ B	<b>3SE5 000-0AA11-1AJ0</b>	1 1 unit
<b>Twist levers, adjustable length, with grid hole</b>					
	Metal lever, plastic roller	19	⊕ B	<b>3SE5 000-0AA60-1AJ0</b>	1 1 unit
Twist lever, adjustable length	High-grade steel lever, plastic roller	19	⊕ B	<b>3SE5 000-0AA62-1AJ0</b>	1 1 unit

⊕ Positively driven actuator, necessary in safety circuits.

### Overview

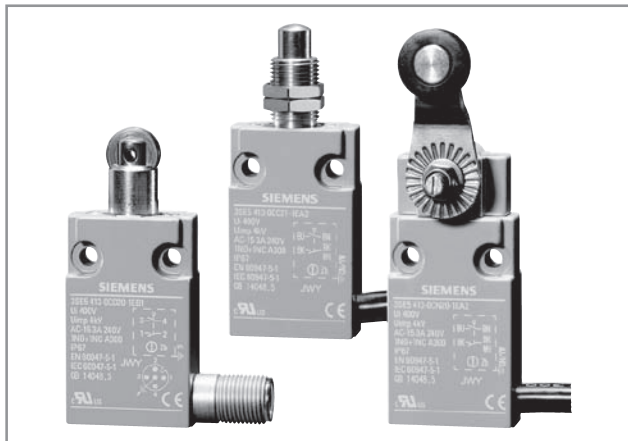

Compact design in width 30 mm

Particularly in harsh environments or on equipment with limited space, the small 3SE5 4 position switches in compact design with a depth of 16 mm and a weight of only 80 g (without cable) are ideal. Above all the versions with molded cable can be mounted in the most confined places.

3SE5 4 compact position switches are available in two different widths as complete units:

- The 3SE5 413 series complies with the EU standard and features a 30 mm wide enclosure with drilled holes at a distance of 20 mm.
- The 3SE5 423 series meets the requirements of the US market and features a 40 mm wide enclosure with drilled holes at a spacing of 25 mm.

Both the enclosure and the twist actuator are made of metal and comply with the high IP67 degree of protection. Following actuators are available:

- Rounded plungers
- Rounded plungers with central fixing
- Rounded plungers with external seal
- Roller plungers
- Roller plunger with central fixing
- Twist levers

The contact block is designed with snap-action contacts 1 NO + 1 NC. The NC contact complies with the requirements for positive opening acc. to IEC 60947-5-1.

Use in safety circuits up to Category 4 according to EN ISO 13849-1.

Connection:

- With molded cable, 2 m or 5 m long
- With M12 connector socket

### Benefits

- Very compact yet with the same rating as the 3SE51 standard switches, for notable space savings in confined installation conditions
- Various actuator versions available
- Actuator heads rotatable in increments of 90°
- Time is saved when mounting the fully assembled unit
- With metal enclosure of degree of protection IP67, ideal for use in rough industrial environments
- Insensitive to electromagnetic interference

# Limit Switches

## SIRIUS 3SE5 International Limit Switches

3SE5, metal enclosures  
Compact design

### Selection and ordering data

2 snap-action contacts 1 NO + 1 NC · Degree of protection IP67 · With connecting cable or M12 connector socket

Operating mechanism	Enclosure width	DT	Configurator	PU (UNIT, SET, M)	PS*
	mm		Order No. Price per PU		

### Complete units · Enclosure width 30 or 40 mm

#### Rounded plungers

- Standard mounting
  - With 2 m cable 5 x 0.75 mm<sup>2</sup>
  - With 5 m cable 5 x 0.75 mm<sup>2</sup>
  - With M12 connector socket



Rounded plunger

- With central fixing M12 x 1
  - With 2 m cable 5 x 0.75 mm<sup>2</sup>



With central fixing

- With external seal
  - With 2 m cable 5 x 0.75 mm<sup>2</sup>



With external seal

#### Roller plungers

- Standard mounting
  - With 2 m cable 5 x 0.75 mm<sup>2</sup>
  - With 5 m cable 5 x 0.75 mm<sup>2</sup>
  - With M12 connector socket



Roller plunger

- With central fixing M12 x 1
  - With 2 m cable 5 x 0.75 mm<sup>2</sup>



With plug

- Actuator head rotated 90°
  - With 2 m cable 5 x 0.75 mm<sup>2</sup>



With plug, enclosure width 40 mm

#### Twist levers

- Standard mounting
  - With 2 m cable 5 x 0.75 mm<sup>2</sup>
  - With 5 m cable 5 x 0.75 mm<sup>2</sup>
  - With M12 connector socket



Twist lever

30	⊕ A	<b>3SE5 413-0CC20-1EA2</b>	1	1 unit
40	⊕ ▶	<b>3SE5 423-0CC20-1EA2</b>	1	1 unit
30	⊕ B	<b>3SE5 413-0CC20-1EA5</b>	1	1 unit
30	⊕ A	<b>3SE5 413-0CC20-1EB1</b>	1	1 unit
40	⊕ A	<b>3SE5 423-0CC20-1EB1</b>	1	1 unit
30	⊕ ▶	<b>3SE5 413-0CC21-1EA2</b>	1	1 unit
40	⊕ A	<b>3SE5 423-0CC21-1EA2</b>	1	1 unit
30	⊕ A	<b>3SE5 413-0CC22-1EA2</b>	1	1 unit
40	⊕ A	<b>3SE5 423-0CC22-1EA2</b>	1	1 unit
30	⊕ ▶	<b>3SE5 413-0CD20-1EA2</b>	1	1 unit
40	⊕ ▶	<b>3SE5 423-0CD20-1EA2</b>	1	1 unit
30	⊕ B	<b>3SE5 413-0CD20-1EA5</b>	1	1 unit
30	⊕ A	<b>3SE5 413-0CD20-1EB1</b>	1	1 unit
40	⊕ A	<b>3SE5 423-0CD20-1EB1</b>	1	1 unit
30	⊕ A	<b>3SE5 413-0CD21-1EA2</b>	1	1 unit
40	⊕ A	<b>3SE5 423-0CD21-1EA2</b>	1	1 unit
30	⊕ A	<b>3SE5 413-0CD23-1EA2</b>	1	1 unit
30	⊕ ▶	<b>3SE5 413-0CN20-1EA2</b>	1	1 unit
40	⊕ A	<b>3SE5 423-0CN20-1EA2</b>	1	1 unit
30	⊕ A	<b>3SE5 413-0CN20-1EA5</b>	1	1 unit
30	⊕ A	<b>3SE5 413-0CN20-1EB1</b>	1	1 unit
40	⊕ A	<b>3SE5 423-0CN20-1EB1</b>	1	1 unit

⚙ For online configurator see [www.siemens.com/sirius/configurators](http://www.siemens.com/sirius/configurators).

⊕ Positive opening according to IEC 60947-5-1, Appendix K.

# Limit Switches

## SIRIUS 3SE5 International Limit Switches

3SE5, open-type design

1

2

3

4

5

6

7

8

9

10

11

12

13

### Overview



Open-type design

Their compact design makes these switches particularly suitable for use in confined conditions. The fixing dimensions and operating points are according to EN 50047.

The switches are equipped with two or three contacts in slow-action or snap-action versions. The stroke is 6 mm.

The empty enclosure can be equipped with all switch block versions (see page 13/49).

### Selection and ordering data

2 or 3 contacts · Degree of protection IP20 (2 contacts), IP10 (3 contacts)

Version	Contacts	DT	Configurator	Order No.	Price per PU	PU (UNIT, SET, M)	PS*
---------	----------	----	--------------	-----------	--------------	-------------------	-----

#### Plastic enclosures · Enclosure width 30 mm

##### With teflon plunger, Ø 6 mm



2 contacts

Slow-action contacts	1 NO + 1 NC	⊕ ▶	<b>3SE5 250-0BC05</b>			1	1 unit
Snap-action contacts	1 NO + 1 NC	⊕ ▶	<b>3SE5 250-0CC05</b>			1	1 unit



3 contacts

Slow-action contacts	1 NO + 2 NC	⊕ ▶	<b>3SE5 250-0KC05</b>			1	1 unit
Snap-action contacts	1 NO + 2 NC	⊕ ▶	<b>3SE5 250-0LC05</b>			1	1 unit
Slow-action contacts with make-before-break	1 NO + 2 NC	⊕ A	<b>3SE5 250-0MC05</b>			1	1 unit
Slow-action contacts	2 NO + 1 NC	⊕ ▶	<b>3SE5 250-0PC05</b>			1	1 unit



Empty enclosures

Empty enclosures without contact block	—	⊕ B	<b>3SE5 250-0AC05</b>			1	1 unit
--	---	-----	-----------------------	--	--	---	--------



2 contacts

Contact blocks with 2 contacts for open-type design <sup>1)</sup>							
• Slow-action contacts	1 NO + 1 NC	⊕ B	<b>3SE5 050-0BA00</b>			1	1 unit
• Snap-action contacts	1 NO + 1 NC						
- Standard		⊕ B	<b>3SE5 050-0CA00</b>			1	1 unit
- 2 × 2 mm switching interval		⊕ B	<b>3SE5 050-0GA00</b>			1	1 unit
- Short stroke		⊕ B	<b>3SE5 050-0NA00</b>			1	1 unit

⚙ For online configurator see [www.siemens.com/sirius/configurators](http://www.siemens.com/sirius/configurators).

⊕ Positive opening according to IEC 60947-5-1, Appendix K.

<sup>1)</sup> Contact blocks with 3 contacts see page 13/49.

# Limit Switches

## SIRIUS 3SE5 International Limit Switches

### Accessories

#### Selection and ordering data

Version	DT	Order No.	List Price \$ per PU	PU (UNIT, SET, M)	PS*	PG	Weight per PU approx. kg
<b>Plug-in connections for M20 × 1.5 connecting threads</b>							
 3SY3 131	 3SY3 136	<b>Connector sockets (6-pole+PE), for M20×1.5</b> B For max. 250 V, 10 A With 0.75 mm <sup>2</sup> connecting cable, plastic, degree of protection IP65, ambient temperature -40 to +90 °C	3SY3 131	1	1 unit	102	0.030
		<b>Cable boxes (6-pole + PE)<sup>1)</sup></b> A With terminal compartment, can be pre-assembled, plastic, degree of protection IP65	3SY3 136	1	1 unit	102	0.065
 3SY3 127	 3RX8 000	<b>Connector sockets (4-pole), M12, for M20 × 1.5, fixed</b> B For max 250 V, 4 A, $U_{imp} = 2500$ V With four 0.25 mm <sup>2</sup> connecting cables, plastic, degree of protection IP67, ambient temperature -40 to +85 °C	3SY3 127	1	1 unit	102	0.010
		<b>Cable boxes (4-pole), M12, with terminal compartment, can be pre-assembled</b> A <b>Angular cable boxes (4-pole), M12, with terminal compartment, can be pre-assembled</b> A	3RX8 000-0CB45 3RX8 000-0CC45	1 1	1 unit 1 unit	574 574	0.015 0.015
 3SY3 127	 3RX8 000	<b>Connector sockets (5-pole), M12, for M20 × 1.5, fixed</b> B For max 125 V, 4 A, $U_{imp} = 1500$ V With five 0.25 mm <sup>2</sup> connecting cables, plastic, degree of protection IP67, ambient temperature -40 to +85 °C	3SY3 128	1	1 unit	102	0.010
		<b>Cable boxes (5-pole), M12, with terminal compartment, can be pre-assembled</b> A <b>Angular cable boxes (5-pole), M12, with terminal compartment, can be pre-assembled</b> A	3RX8 000-0CB55 3RX8 000-0CC55	1 1	1 unit 1 unit	574 574	0.016 0.016
 3SY3 134		<b>Connector sockets (8-pole), M12, for M20 × 1.5, fixed, metal version</b> B For max 30 V, 2 A, $U_{imp} = 800$ V With eight 0.25 mm <sup>2</sup> connecting cables, metal, degree of protection IP67, ambient temperature -40 to +85 °C	3SY3 134	1	1 unit	102	0.025
		<b>Cable boxes (8-pole), M12</b> A With 5 m PUR cable, 8 × 0.25 mm <sup>2</sup> , IP67	3RX8 000-0CB81-1GF0	1	1 unit	574	0.335
<b>Adaptors for 3SE. (with M 16)</b>							
 3SX1997		metal M16 x 1.5 to 1/2" NPT	▶ 3SX1997	1	1 unit		0.022
<b>Adaptors for 3SE2 (with M 20)</b>							
 3SX9918		plastic M20 x 1.5 wire gland	▶ 3SB3901-OCK	1	1 unit		0.011
 3SX1998	 3SX9918	metal M20 x 1.5 to 1/2" NPT	▶ 3SX1998	1	1 unit		0.022
 3SX1998	 3SX9918	plastic M20 x 1.5 to 1/2" NPT	▶ 3SX9918	1	1 unit		0.012
 3SX9926		plastic cable gland, M20 x 1.5	▶ 3SX9926	1	1 unit		0.010
<b>Adaptors for 3SE. (with M 25)</b>							
 3SX1999		metal M 25 x 1.5 to 1/2" NPT	▶ 3SX1999	1	1 unit		0.022

<sup>1)</sup> For wiring, a crimping tool is necessary, max. conductor cross-section 1 mm<sup>2</sup>.









# Limit Switches

## SIRIUS 3SE5 International Limit Switches

### Accessories and spare parts

1  
2  
3  
4  
5  
6  
7  
8  
9  
10  
11  
12  
13

Version	Color/ contacts	DT	Order No.	Price per PU	PU (UNIT, SET, M)	PS*
<b>Optional accessories for 3SE52</b>						
	<b>Protective caps, rubber,</b> for rounded plungers acc. to EN 50047, 3SE5 ...-...C05	Black	A	<b>3SE5 000-0AC30</b>	1	1 unit
<b>Spare parts for 3SE51, 3SE52</b>						
	<b>Empty enclosures, plastic</b>	Turquoise				
	Enclosure width 31 mm		B	<b>3SE5 232-0AC05</b>	1	1 unit
	• With increased corrosion protection		B	<b>3SE5 232-0AC05-1CA0</b>	1	1 unit
	Enclosure width 50 mm		B	<b>3SE5 242-0AC05</b>	1	1 unit
	• With increased corrosion protection		B	<b>3SE5 242-0AC05-1CA0</b>	1	1 unit
Enclosure width 31 mm						
	<b>Empty enclosures, metal</b>	Turquoise				
	Enclosure width 31 mm		B	<b>3SE5 212-0AC05</b>	1	1 unit
	• With increased corrosion protection		B	<b>3SE5 212-0AC05-1CA0</b>	1	1 unit
	Enclosure width 40 mm		B	<b>3SE5 112-0AA00</b>	1	1 unit
	• With increased corrosion protection		B	<b>3SE5 112-0AA00-1CA0</b>	1	1 unit
	Enclosure width 56 mm		B	<b>3SE5 122-0AA00</b>	1	1 unit
	• With increased corrosion protection		B	<b>3SE5 122-0AA00-1CA0</b>	1	1 unit
Enclosure width 40 mm	Enclosure width 56 mm, XL <sup>1)</sup>		B	<b>3SE5 162-0AA00</b>	1	1 unit
	<b>Contact blocks with 2 contacts<sup>2)</sup></b>					
	• Slow-action contacts	1 NO + 1 NC	⊕ ▶	<b>3SE5 000-0BA00</b>	1	1 unit
	• Snap-action contacts	1 NO + 1 NC				
	- Standard		⊕ B	<b>3SE5 000-0CA00</b>	1	1 unit
	- Gold-plated contacts		⊕ B	<b>3SE5 000-0CA00-1AC1</b>	1	1 unit
	- 2 x 2 mm switching interval		⊕ B	<b>3SE5 000-0GA00</b>	1	1 unit
	- Short stroke		⊕ B	<b>3SE5 000-0NA00</b>	1	1 unit
2 contacts						
	<b>Contact blocks with 3 contacts</b>					
	• Slow-action contacts	1 NO + 2 NC	⊕ B	<b>3SE5 000-0KA00</b>	1	1 unit
	• Snap-action contacts	1 NO + 2 NC	⊕ B	<b>3SE5 000-0LA00</b>	1	1 unit
	• Slow-action contacts with make-before-break	1 NO + 2 NC	⊕ A	<b>3SE5 000-0MA00</b>	1	1 unit
	• Slow-action contacts	2 NO + 1 NC	A	<b>3SE5 000-0PA00</b>	1	1 unit
3 contacts						
	<b>Contact blocks for enclosure XL<sup>1)</sup></b>					
	• Slow-action contacts	1 NO + 1 NC	⊕ B	<b>3SE5 060-0BA00</b>	1	1 unit
	• Snap-action contacts	1 NO + 1 NC	⊕ B	<b>3SE5 060-0CA00</b>	1	1 unit
	• Slow-action contacts with make-before-break	1 NO + 2 NC	⊕ B	<b>3SE5 060-0MA00</b>	1	1 unit
2 contacts						

⊕ Positive opening according to IEC 60947-5-1, Appendix K.







1) Equip XL enclosures only with contact combinations according to pages 12/11, 12/42 and 12/43.

2) Unsuitable for open-type position switches; see page 13/47.

# Limit Switches

## SIRIUS 3SE5 International Limit Switches

### Accessories and spare parts

Version	Rated voltage LED	DT	Order No.	Price per PU	PU (UNIT, SET, M)	PS*
V						
<b>Spare parts for 3SE51, 3SE52</b>						
 31 mm, turquoise with LED	<b>Covers for plastic enclosures, width 31 mm</b>					
	• Turquoise with LED	24 DC	B	<b>3SE5 230-1AA00</b>		1 1 unit
		230 AC	B	<b>3SE5 230-3AA00</b>		1 1 unit
	• Yellow	—	B	<b>3SE5 230-0AA00-1AG0</b>		1 1 unit
	• Yellow with LED	24 DC	B	<b>3SE5 230-1AA00-1AG0</b>		1 1 unit
		230 AC	B	<b>3SE5 230-3AA00-1AG0</b>		1 1 unit
 40 mm, yellow with LED	<b>Covers for plastic enclosures, width 40 mm</b>					
	• Turquoise with LED	24 DC	B	<b>3SE5 130-1AA00</b>		1 1 unit
		230 AC	B	<b>3SE5 130-3AA00</b>		1 1 unit
	• Yellow	—	B	<b>3SE5 130-0AA00-1AG0</b>		1 1 unit
	• Yellow with LED	24 DC	B	<b>3SE5 130-1AA00-1AG0</b>		1 1 unit
		230 AC	B	<b>3SE5 130-3AA00-1AG0</b>		1 1 unit
 50 mm, turquoise with LED	<b>Covers for plastic enclosures, width 50 mm</b>					
	• Turquoise with LED	24 DC	B	<b>3SE5 240-1AA00</b>		1 1 unit
		230 AC	B	<b>3SE5 240-3AA00</b>		1 1 unit
	• Yellow	—	B	<b>3SE5 240-0AA00-1AG0</b>		1 1 unit
	• Yellow with LED	24 DC	B	<b>3SE5 240-1AA00-1AG0</b>		1 1 unit
		230 AC	B	<b>3SE5 240-3AA00-1AG0</b>		1 1 unit
 31 mm, turquoise with LED	<b>Covers for metal enclosures, width 31 mm</b>					
	• Turquoise with LED	24 DC	B	<b>3SE5 210-1AA00</b>		1 1 unit
		230 AC	B	<b>3SE5 210-3AA00</b>		1 1 unit
	• Yellow	—	B	<b>3SE5 210-0AA00-1AG0</b>		1 1 unit
	• Yellow with LED	24 DC	B	<b>3SE5 210-1AA00-1AG0</b>		1 1 unit
		230 AC	B	<b>3SE5 210-3AA00-1AG0</b>		1 1 unit
 40 mm, yellow with LED	<b>Covers for metal enclosures, width 40 mm</b>					
	• Turquoise with LED	24 DC	B	<b>3SE5 110-1AA00</b>		1 1 unit
		230 AC	B	<b>3SE5 110-3AA00</b>		1 1 unit
	• Yellow	—	B	<b>3SE5 110-0AA00-1AG0</b>		1 1 unit
	• Yellow with LED	24 DC	B	<b>3SE5 110-1AA00-1AG0</b>		1 1 unit
		230 AC	B	<b>3SE5 110-3AA00-1AG0</b>		1 1 unit
 56 mm, yellow with LED	<b>Covers for metal enclosures, width 56 mm</b>					
	• Turquoise with LED	24 DC	B	<b>3SE5 120-1AA00</b>		1 1 unit
		230 AC	B	<b>3SE5 120-3AA00</b>		1 1 unit
	• Yellow	—	B	<b>3SE5 120-0AA00-1AG0</b>		1 1 unit
	• Yellow with LED	24 DC	B	<b>3SE5 120-1AA00-1AG0</b>		1 1 unit
		230 AC	B	<b>3SE5 120-3AA00-1AG0</b>		1 1 unit
<b>Covers for XL metal enclosures, width 56 mm</b>						
• Yellow	—	B	<b>3SE5 160-0AA00-1AG0</b>		1 1 unit	

#### Technical specifications

Type		3SE5 1..., 3SE5 2..	3SE5 41.	3SE5 42.
<b>General data</b>				
<b>Standards</b>		IEC 60947-5-1, EN 60947-5-1		
<b>Rated insulation voltage <math>U_i</math></b>	V	400	400	
<b>Pollution degree</b> acc. to IEC 60664-1		Class 3	Class 3	
<b>Rated impulse withstand voltage <math>U_{imp}</math></b>	kV	6	4	
<b>Rated operational voltage <math>U_e</math></b>	V	400 V AC, over 300 V AC only for equal potential <sup>1)</sup>		300 AC
<b>Conventional thermal current <math>I_{th}</math></b>	A	10	6	10
<b>Rated operational current <math>I_e</math></b>		2-pole	3-pole	2-pole
• With alternating current 50/60 Hz		$I_e/AC-15$	$I_e/AC-15$	$I_e/AC-15$
- At 24 V	A	6	6	6
- At 120 V	A	6	3	6
- At 240 V	A	3	1.5	3
• For direct current		$I_e/DC-13$	$I_e/DC-13$	$I_e/DC-13$
- At 24 V	A	3	3	3
- At 125 V	A	0.55	0.55	0.55
- At 250 V	A	0.27	0.27	0.27
<b>Short-circuit protection<sup>2)</sup></b>				
• With DIAZED fuse links, gG operational class	A	6		
• With miniature circuit breaker, Char. C	A	1	2	1
<b>Mechanical endurance</b>				
• Basic switches		15 × 10 <sup>6</sup> operating cycles	30 × 10 <sup>6</sup> operating cycles	30 × 10 <sup>6</sup> operating cycles
• With spring rod, 3SE5 ...-...R..		10 × 10 <sup>6</sup> operating cycles	—	—
• With fork lever 3SE5 1...-...T..		1 × 10 <sup>6</sup> operating cycles	—	—
<b>Electrical endurance</b>				
• With 3RH.1, 3RT contactors in size S00, S0		10 × 10 <sup>6</sup> operating cycles	10 × 10 <sup>6</sup> operating cycles	5 × 10 <sup>6</sup> operating cycles
• For utilization category AC-15 when switching off $I_e/AC-15$ at 240 V		0.1 × 10 <sup>6</sup> operating cycles	—	—
• With utilization category DC-12/DC-13		For direct current depending on the loading of the switch		
<b>Switching frequency</b>		6000 operating cycles/h	1800 operating cycles/h	
With 3RH.1, 3RT contactors in size S00, S0				
<b>Switching accuracy</b>	mm	0.05		
For repeated switching, measured at the plunger of the contact block				
• With twist actuators		1°		
<b>Rated data acc. to <math>\mathcal{E}</math>, <math>\mathcal{R}</math> and <math>\mathcal{V}</math></b>				
• Rated voltage	V	300		
• Uninterrupted current	A	6		
• Switching capacity		Heavy duty, A 300 / B 300 / Q 300	A 300 / Q 300	

<sup>1)</sup> For slow-action contacts 1 NO + 2 NC with make-before-break and 2 NO + 1 NC the following applies: over 250 V AC only equal potential

<sup>2)</sup> Without any welds according to IEC 60947-5-1.

Type		3SE5 23.	3SE5 13	3SE5 24.	3SE5 21.	3SE5 11.	3SE5 12., 3SE5 16.	3SE5 4..	3SE5 25.
<b>Enclosure</b>									
<b>Enclosure</b>		Ultramid A3X2G7			Zinc diecasting GD Zn Al4 Cu1			—	
• Material									
• Width	mm	31	40	50	31	40	56	30 / 40	30
<b>Degree of protection</b> acc. to IEC 60529		IP65	IP66/IP67 <sup>1)</sup>					IP67	IP20, IP10
<b>Ambient temperature</b>									
• During operation	°C	-25 ... +85						-25 ... +85	-25 ... +85
• In operation, switch with LEDs	°C	-25 ... +70						—	—
• Storage, transport	°C	-40 ... +90						-40 ... +90	-40 ... +90
<b>Mounting position</b>		Any							
<b>Connection</b>									
<b>Cable entry</b>		1 × (M20 × 1.5)		2 × (M20 × 1.5)	1 × (M20 × 1.5)		3 × (M20 × 1.5)	—	—
<b>Conductor cross-sections<sup>2)</sup></b>									
• Solid	mm <sup>2</sup>	2 × (0.5 ... 0.75), 1 × (0.5 ... 1.5)							
• Finely stranded with end sleeve	mm <sup>2</sup>	2 × (0.5 ... 1.5)							
<b>Tightening torque</b> , contact block	Nm	0.8 ... 1.0							
<b>Protective conductor connection</b> inside enclosure		—			M3.5		—		

<sup>1)</sup> For twist actuators with spring rod and rod actuators: IP65/IP67.

<sup>2)</sup> For the maximum number of connectable conductors for the respective contact block see operating instructions.

# Limit Switches

## SIRIUS 3SE5 International Limit Switches

3SE5, plastic enclosures  
Enclosure widths 31 mm and 50 mm

### Configuration

#### Actuation and operating travel (angle) for enclosure width 31 mm and 50 mm

Operation by bar (standard)		Slow-action contacts		Snap-action contacts	
<ul style="list-style-type: none"> <li>○ Operating point acc. to EN 50047 (snap-action)</li> <li>* Operating point on return (snap-action)</li> <li>⊕ Positive opening acc. to EN 60947-5-1</li> <li>→ Direction of operation</li> <li><math>v_{max}</math> Max. actuating speed</li> <li>■ Contact closed</li> <li>□ Contact open</li> </ul>	<p><b>1 NO + 1 NC</b></p> <p>Ident. No. <b>11</b></p>	<p><b>1 NO + 2 NC</b></p> <p>Ident. No. <b>12</b></p>	<p><b>1 NO + 1 NC</b></p> <p>Ident. No. <b>11</b></p>	<p><b>1 NO + 2 NC</b></p> <p>Ident. No. <b>12</b></p>	
<p><b>Rounded plungers, type B</b></p> <p><b>3SE5 2...-C05</b></p> <p><math>v_{max} = 1 \text{ m/s}</math> Minimum force required in direction of operation: 18 N</p>		<p>Actuation along plunger axis</p> <p><b>-BC05</b></p> <p>Ident. No. NSCO_00831a</p>		<p>Actuation along plunger axis</p> <p><b>-KC05</b></p> <p>Ident. No. NSCO_00833a</p>	
		<p>Actuation along plunger axis</p> <p><b>-CC05, -HC05</b></p> <p>Ident. No. NSCO_00832a</p>		<p>Actuation along plunger axis</p> <p><b>-FC05</b></p> <p>Ident. No. NSCO_00835a</p>	
		<p>Actuation along plunger axis</p> <p><b>-GC05</b></p> <p>Ident. No. NSCO_00836a</p>		<p>Actuation along plunger axis</p> <p><b>-LC05</b></p> <p>Ident. No. NSCO_00834a</p>	
		<p>Actuation along plunger axis</p> <p><b>-BF10</b></p> <p>Ident. No. NSCO_00857a</p>		<p>Actuation along plunger axis</p> <p><b>-KF10</b></p> <p>Ident. No. NSCO_00858a</p>	
		<p>Actuation along plunger axis</p> <p><b>-HF10</b></p> <p>Ident. No. NSCO_00858a</p>		<p>Actuation along plunger axis</p> <p><b>-FC05 + head<sup>1)</sup></b></p> <p>Ident. No. NSCO_00843</p>	
		<p>Actuation along plunger axis</p> <p><b>-GC05 + head<sup>1)</sup></b></p> <p>Ident. No. NSCO_00858a</p>		<p>Actuation along plunger axis</p> <p><b>-LF10</b></p> <p>Ident. No. NSCO_00860a</p>	
		<p>Actuation along plunger axis</p> <p><b>-BF10</b></p> <p>Ident. No. NSCO_00857a</p>		<p>Actuation along plunger axis</p> <p><b>-KF10</b></p> <p>Ident. No. NSCO_00858a</p>	
		<p>Actuation along plunger axis</p> <p><b>-HF10</b></p> <p>Ident. No. NSCO_00858a</p>		<p>Actuation along plunger axis</p> <p><b>-FC05 + head<sup>1)</sup></b></p> <p>Ident. No. NSCO_00843</p>	
		<p>Actuation along plunger axis</p> <p><b>-GC05 + head<sup>1)</sup></b></p> <p>Ident. No. NSCO_00858a</p>		<p>Actuation along plunger axis</p> <p><b>-LF10</b></p> <p>Ident. No. NSCO_00860a</p>	
<p><b>Operation by bar (standard)</b></p> <ul style="list-style-type: none"> <li>○ Operating point acc. to EN 50047 (snap-action)</li> <li>* Operating point on return (snap-action)</li> <li>⊕ Positive opening acc. to EN 60947-5-1</li> <li>→ Direction of operation</li> <li><math>v_{max}</math> Max. actuating speed</li> </ul>		<p><b>Slow-action contacts</b></p> <ul style="list-style-type: none"> <li>■ Contact closed</li> <li>□ Contact open</li> </ul>		<p><b>Snap-action contacts</b></p> <ul style="list-style-type: none"> <li>■ Contact closed</li> <li>□ Contact open</li> </ul>	
<p><b>Roller plungers</b></p> <p><b>3SE5 2...-D03, -D04</b> <b>3SE5 2...-D10, -D11</b></p> <p><b>Form C</b> <b>Central fixing</b></p> <p><math>v_{max} = 1 \text{ m/s}</math> Minimum force required in direction of operation: 18 N</p>		<p>Lateral actuation</p> <p><b>1 NO + 1 NC</b></p> <p>Ident. No. <b>11</b></p>		<p>Lateral actuation</p> <p><b>3SE5 2...-BD03</b></p> <p>Ident. No. NSCO_00837a</p>	
		<p>Lateral actuation</p> <p><b>1 NO + 1 NC</b></p> <p>Ident. No. <b>11</b></p>		<p>Lateral actuation</p> <p><b>3SE5 2...-HD03, -HD10</b></p> <p>Ident. No. NSCO_00838a</p>	
		<p>Lateral actuation</p> <p><b>1 NO + 1 NC</b></p> <p>Ident. No. <b>11</b></p>		<p>Lateral actuation</p> <p><b>3SE5 2...-FC05 + head<sup>1)</sup></b></p> <p>Ident. No. NSCO_00841</p>	
		<p>Lateral actuation</p> <p><b>1 NO + 2 NC</b></p> <p>Ident. No. <b>12</b></p>		<p>Lateral actuation</p> <p><b>3SE5 2...-LD03</b></p> <p>Ident. No. NSCO_00840a</p>	
		<p>Lateral actuation</p> <p><b>1 NO + 2 NC</b></p> <p>Ident. No. <b>12</b></p>		<p>Lateral actuation</p> <p><b>3SE5 2...-LD03</b></p> <p>Ident. No. NSCO_00840a</p>	

<sup>1)</sup> The basic switch and actuator head/actuator head must be ordered separately.

# Limit Switches

## SIRIUS 3SE5 International Limit Switches

3SE5, plastic enclosures  
Enclosure widths 31 mm and 50 mm

### Configuration

Actuation and operating travel (angle) for enclosure width 31 mm and 50 mm

Operation by bar (standard)	Slow-action contacts	Snap-action contacts
<ul style="list-style-type: none"> <li>○ Operating point acc. to EN 50047 (snap-action)</li> <li>* Operating point on return (snap-action)</li> <li>⊕ Positive opening acc. to EN 60947-5-1</li> <li>→ Direction of operation</li> <li><math>v_{max}</math> Max. actuating speed</li> </ul>	<ul style="list-style-type: none"> <li>■ Contact closed</li> <li>□ Contact open</li> </ul>	<ul style="list-style-type: none"> <li>■ Contact closed</li> <li>□ Contact open</li> </ul>
<b>Roller levers, type E</b>		
<p><b>3SE5 2...-E1.</b></p> <p><math>v_{max} = 1 \text{ m/s}</math> Minimum force required in direction of operation: 9 N</p>	<p>Lateral actuation</p> <p><b>1 NO + 1 NC</b> <b>3SE5 2...-BE10</b> NSCO_00849a</p> <p>Ident. No. <b>11</b></p>	<p>Lateral actuation</p> <p><b>1 NO + 1 NC</b> <b>3SE5 2...-HE10</b> NSCO_00850a</p> <p>Ident. No. <b>11</b></p>
	<p><b>1 NO + 2 NC</b> <b>3SE5 2...-KE10</b> NSCO_00851a</p> <p>Ident. No. <b>12</b></p>	<p><b>1 NO + 1 NC</b> <b>3SE5 2...-FC05 + head<sup>2)</sup></b> NSCO_00842</p> <p>Short stroke</p> <p>Ident. No. <b>11</b></p>
	<p><b>1 NO + 2 NC</b> <b>3SE5 2...-LE10</b> NSCO_00852a</p> <p>Ident. No. <b>12</b></p>	<p><b>1 NO + 2 NC</b> <b>3SE5 2...-LC05 + head<sup>2)</sup></b> NSCO_00868a</p> <p>Short stroke</p> <p>Ident. No. <b>11</b></p>
	<p><b>1 NO + 2 NC</b> <b>3SE5 2...-LK21</b> NSCO_00868a</p> <p>Ident. No. <b>12</b></p>	<p><b>1 NO + 2 NC</b> <b>3SE5 2...-LC05 + head<sup>2)</sup></b> NSCO_00868a</p> <p>Ident. No. <b>12</b></p>
<b>Twist levers<sup>1)</sup>, type A</b>		
<p><b>3SE5 2...-K2.</b></p> <p><math>v_{max} = 1.5 \text{ m/s}</math> Minimum torque in direction of operation: 0.25 Nm</p>	<p>Deflection in direction of rotation</p> <p><b>1 NO + 1 NC</b> <b>3SE5 2...-BK21</b> NSCO_00865a</p> <p>Ident. No. <b>11</b></p>	<p>Deflection in direction of rotation</p> <p><b>1 NO + 1 NC</b> <b>3SE5 2...-HK21</b> NSCO_00866a</p> <p>Ident. No. <b>11</b></p>
	<p><b>1 NO + 2 NC</b> <b>3SE5 2...-KK21</b> NSCO_00867a</p> <p>Ident. No. <b>12</b></p>	<p><b>1 NO + 1 NC</b> <b>3SE5 2...-FC05 + head<sup>2)</sup></b> NSCO_00926</p> <p>Short stroke</p> <p>Ident. No. <b>11</b></p>
	<p><b>1 NO + 2 NC</b> <b>3SE5 2...-KC05 + head<sup>2)</sup></b> NSCO_00867a</p> <p>Ident. No. <b>12</b></p>	<p><b>1 NO + 2 NC</b> <b>3SE5 2...-LC05 + head<sup>2)</sup></b> NSCO_00868a</p> <p>Ident. No. <b>12</b></p>
	<p><b>1 NO + 2 NC</b> <b>3SE5 2...-LK21</b> NSCO_00868a</p> <p>Ident. No. <b>12</b></p>	<p><b>1 NO + 2 NC</b> <b>3SE5 2...-LC05 + head<sup>2)</sup></b> NSCO_00868a</p> <p>Ident. No. <b>12</b></p>
<b>Twist levers<sup>1)</sup>, adjustable length</b>		
<p><b>3SE5 2...-K6.</b></p> <p><math>v_{max} = 1.5 \text{ m/s}</math> Minimum torque in direction of operation: 0.25 Nm</p>	<p>Deflection in direction of rotation</p> <p><b>1 NO + 1 NC</b> <b>3SE5 2...-BC05 + head<sup>2)</sup></b> NSCO_00865a</p> <p>Ident. No. <b>11</b></p>	<p>Deflection in direction of rotation</p> <p><b>1 NO + 1 NC</b> <b>3SE5 2...-HK60</b> NSCO_00866a</p> <p>Ident. No. <b>11</b></p>
	<p><b>1 NO + 2 NC</b> <b>3SE5 2...-KC05 + head<sup>2)</sup></b> NSCO_00867a</p> <p>Ident. No. <b>12</b></p>	<p><b>1 NO + 1 NC</b> <b>3SE5 2...-FC05 + head<sup>2)</sup></b> NSCO_00926</p> <p>Short stroke</p> <p>Ident. No. <b>11</b></p>
	<p><b>1 NO + 2 NC</b> <b>3SE5 2...-KC05 + head<sup>2)</sup></b> NSCO_00867a</p> <p>Ident. No. <b>12</b></p>	<p><b>1 NO + 2 NC</b> <b>3SE5 2...-LC05 + head<sup>2)</sup></b> NSCO_00868a</p> <p>Ident. No. <b>12</b></p>
	<p><b>1 NO + 2 NC</b> <b>3SE5 2...-LK21</b> NSCO_00868a</p> <p>Ident. No. <b>12</b></p>	<p><b>1 NO + 2 NC</b> <b>3SE5 2...-LC05 + head<sup>2)</sup></b> NSCO_00868a</p> <p>Ident. No. <b>12</b></p>

<sup>1)</sup> Adjustment of the lever in increments of 10°, maximum deflection 90°.

<sup>2)</sup> The basic switch and actuator head must be ordered separately.

# Limit Switches

## SIRIUS 3SE5 International Limit Switches

**3SE5, plastic enclosures**  
**Enclosure widths 31 mm and 50 mm**

### Operation by bar (standard)

- ⊙ Operating point acc. to EN 50041/47 (snap-action)
- \* Operating point on return (snap-action)
- ⊕ Positive opening acc. to EN 60947-5-1
- Direction of operation
- $v_{max}$  Max. actuating speed

### Slow-action contacts

- Contact closed
- Contact open

### Snap-action contacts

- Contact closed
- Contact open

### Twist levers<sup>1)</sup>, adjustable length

#### 3SE5 2...-K5.

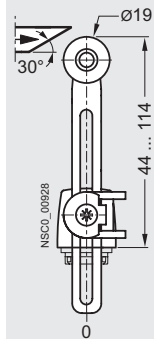

$v_{max} = 1.5$  m/s  
 Minimum torque  
 in direction of operation: 0.25 Nm

#### 1 NO + 1 NC

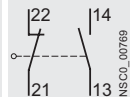

Ident. No. 11

### Deflection in direction of rotation

#### 3SE5 2...-BK50

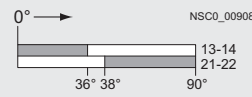

#### 1 NO + 1 NC

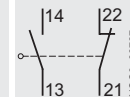

Ident. No. 11

### Deflection in direction of rotation

#### 3SE5 2...-HK50

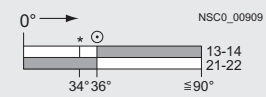

#### 1 NO + 1 NC

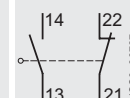

Ident. No. 11

#### 3SE5 2...-FC05 + head<sup>2)</sup>

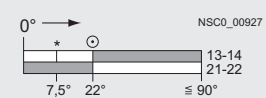

Short stroke

#### 1 NO + 2 NC

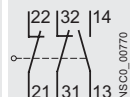

Ident. No. 12

#### 3SE5 2...-KC05 + head<sup>2)</sup>

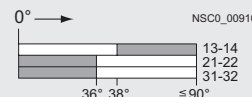

#### 1 NO + 2 NC

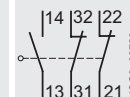

Ident. No. 12

#### 3SE5 2...-LK50

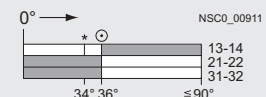

### Rod actuators<sup>1)</sup>, type D

#### 3SE5 2...-K8.

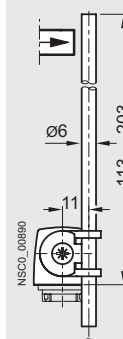

$v_{max} = 1.5$  m/s  
 Minimum torque  
 in direction of operation: 0.25 Nm

#### 1 NO + 1 NC

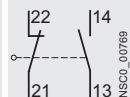

Ident. No. 11

### Deflection in direction of rotation

#### 3SE5 2...-BC05 + head<sup>2)</sup>

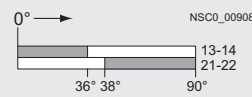

#### 1 NO + 1 NC

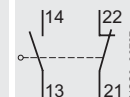

Ident. No. 11

### Deflection in direction of rotation

#### 3SE5 2...-HK80, -HK82

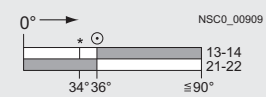

#### 1 NO + 1 NC

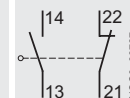

Ident. No. 11

#### 3SE5 2...-FC05 + head<sup>2)</sup>

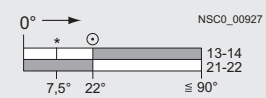

Short stroke

#### 1 NO + 2 NC

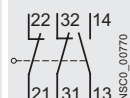

Ident. No. 12

#### 3SE5 2...-KC05 + head<sup>2)</sup>

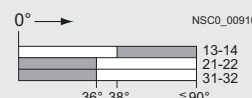

#### 1 NO + 2 NC

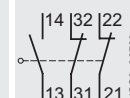

Ident. No. 12

#### 3SE5 2...-LC05 + head<sup>2)</sup>

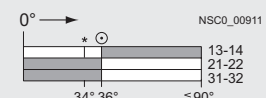

### Spring rods

#### 3SE5 2...-R0.

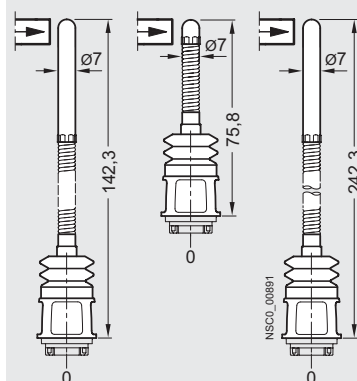

$v_{max} = 1$  m/s  
 Minimum force required  
 in direction of operation: 9 N

The spring rods can be used only with snap-action contacts.

#### 1 NO + 1 NC

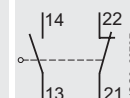

Ident. No. 11

### Deflection of spring rod

#### 3SE5 2...-HR01

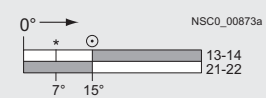

#### 1 NO + 1 NC

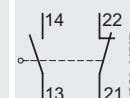

Ident. No. 11

#### 3SE5 2...-FC05 + head<sup>2)</sup>

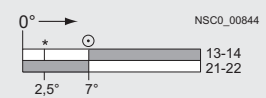

Short stroke

#### 1 NO + 2 NC

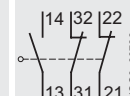

Ident. No. 12

#### 3SE5 2...-LC05 + head<sup>2)</sup>

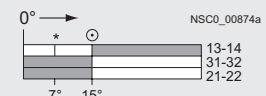

<sup>1)</sup> Adjustment of the lever in increments of 10°, maximum deflection 90°.

<sup>2)</sup> The basic switch and actuator head must be ordered separately.

# Limit Switches



## SIRIUS 3SE5 International Limit Switches

3SE5, metal enclosures  
Enclosure widths 40 mm and 56 mm

1  
2  
3  
4  
5  
6  
7  
8  
9  
10  
11  
13

### Configuration

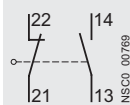
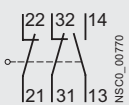
Actuation and operating travel (angle) for enclosure width 40 mm and 56 mm

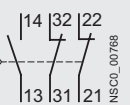
Operation by bar (standard)	Slow-action contacts		Snap-action contacts	
	1 NO + 1 NC	1 NO + 2 NC	1 NO + 1 NC	1 NO + 2 NC
<ul style="list-style-type: none"> <li>⊙ Operating point acc. to EN 50041 (snap-action)</li> <li>* Operating point on return (snap-action)</li> <li>⊕ Positive opening acc. to EN 60947-5-1</li> <li>→ Direction of operation</li> <li><math>v_{max}</math> Max. actuating speed</li> <li> Contact closed</li> <li> Contact open</li> </ul>	 <p>Ident. No. <b>11</b></p>	 <p>Ident. No. <b>12</b></p>	 <p>Ident. No. <b>11</b></p>	 <p>Ident. No. <b>12</b></p>

### Rounded plungers, type B

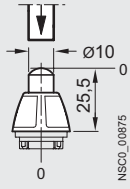
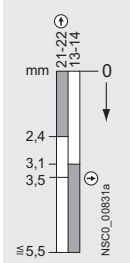
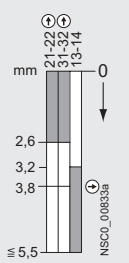
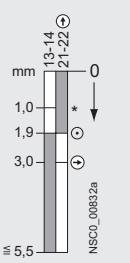
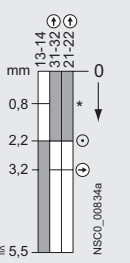
	Actuation along plunger axis		Actuation along plunger axis	
<b>3SE5 1...-C02</b>  <p><math>v_{max} = 1.5 \text{ m/s}</math> Minimum force required in direction of operation: 18 N</p>	<b>3SE5 1...-BC02</b> 	<b>3SE5 1...-KC02</b> 	<b>3SE5 1...-CC02</b> 	<b>3SE5 1...-LC02</b> 

### Angular roller levers

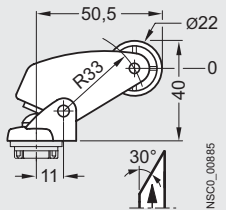
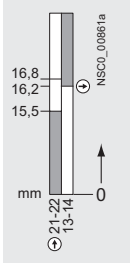
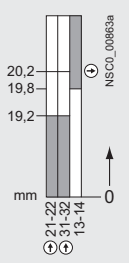
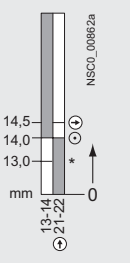
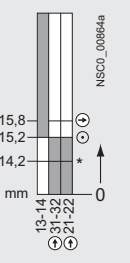
	Actuation along plunger axis		Actuation along plunger axis	
<b>3SE5 112...F0.</b>  <p><math>v_{max} = 2.5 \text{ m/s}</math> Minimum force required in direction of operation: 9 N</p>	<b>3SE5 1...-BF01</b> 	<b>3SE5 1...-KA00 + head<sup>1)</sup></b> 	<b>3SE5 1...-CF01</b> 	<b>3SE5 1...-LF01</b> 

Operation by bar (standard)	Slow-action contacts	Snap-action contacts
<ul style="list-style-type: none"> <li>⊙ Operating point acc. to EN 50041 (snap-action)</li> <li>* Operating point on return (snap-action)</li> <li>⊕ Positive opening acc. to EN 60947-5-1</li> <li>→ Direction of operation</li> <li><math>v_{max}</math> Max. actuating speed</li> </ul>	<ul style="list-style-type: none"> <li> Contact closed</li> <li> Contact open</li> </ul>	<ul style="list-style-type: none"> <li> Contact closed</li> <li> Contact open</li> </ul>

### Roller plungers, type C

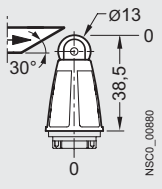
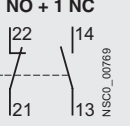
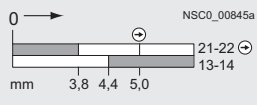
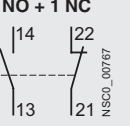
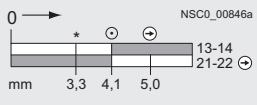
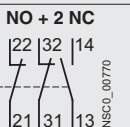
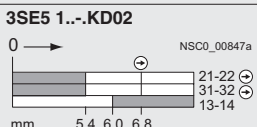
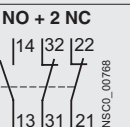
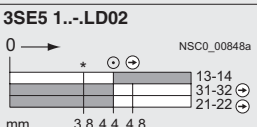
	Lateral actuation		Lateral actuation	
<b>3SE5 1...-D02</b>  <p><math>v_{max} = 1 \text{ m/s}</math> Minimum force required in direction of operation: 18 N</p>	<b>1 NO + 1 NC</b>  <p>Ident. No. <b>11</b></p>	<b>3SE5 1...-BD02</b> 	<b>1 NO + 1 NC</b>  <p>Ident. No. <b>11</b></p>	<b>3SE5 1...-CD02</b> 
	<b>1 NO + 2 NC</b>  <p>Ident. No. <b>12</b></p>	<b>3SE5 1...-KD02</b> 	<b>1 NO + 2 NC</b>  <p>Ident. No. <b>12</b></p>	<b>3SE5 1...-LD02</b> 

<sup>1)</sup> The basic switch and actuator head must be ordered separately.

# Limit Switches

## SIRIUS 3SE5 International Limit Switches

**3SE5, plastic enclosures**  
**Enclosure widths 31 mm and 50 mm**

### Configuration

*Actuation and operating travel (angle) for enclosure width 40 mm and 56 mm*

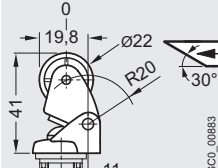
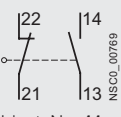
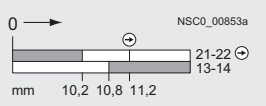
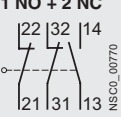
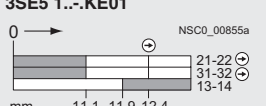
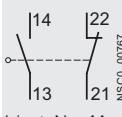
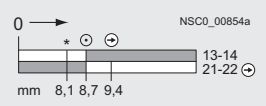
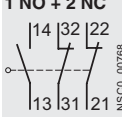
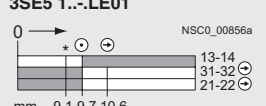
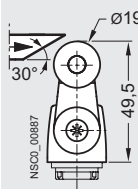
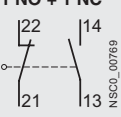
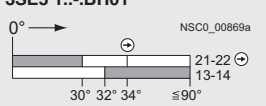
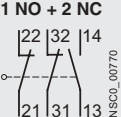
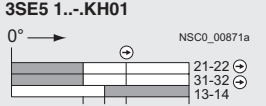
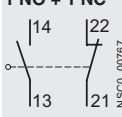
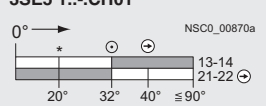
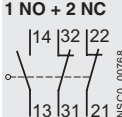
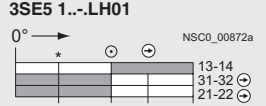
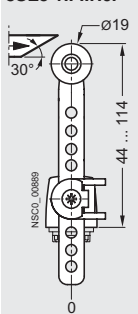
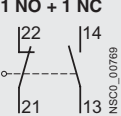
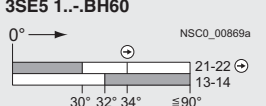
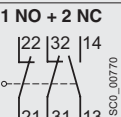
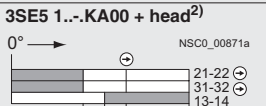
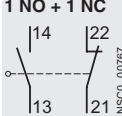
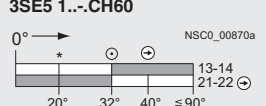
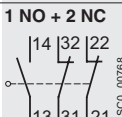
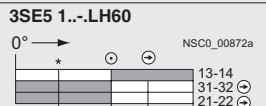
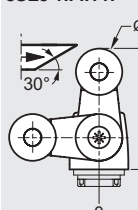
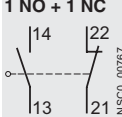
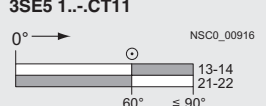
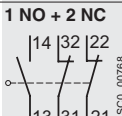
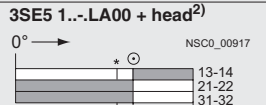
<b>Operation by bar (standard)</b> ○ Operating point acc. to EN 50041 (snap-action) * Operating point on return (snap-action) → Positive opening acc. to EN 60947-5-1 → Direction of operation V <sub>max</sub> Max. actuating speed	<b>Slow-action contacts</b> ■ Contact closed □ Contact open	<b>Snap-action contacts</b> ■ Contact closed □ Contact open
<b>Roller levers</b> <b>3SE5 1...-E0.</b>  <p>V<sub>max</sub> = 2.5 m/s                  Minimum force required in direction of operation: 9 N</p>	<b>Lateral actuation</b> <b>1 NO + 1 NC</b>  <p>Ident. No. <b>11</b></p> <b>3SE5 1...-BE01</b>  <p>Ident. No. <b>11</b></p> <b>1 NO + 2 NC</b>  <p>Ident. No. <b>12</b></p> <b>3SE5 1...-KE01</b>  <p>Ident. No. <b>12</b></p>	<b>Lateral actuation</b> <b>1 NO + 1 NC</b>  <p>Ident. No. <b>11</b></p> <b>3SE5 1...-CE01</b>  <p>Ident. No. <b>11</b></p> <b>1 NO + 2 NC</b>  <p>Ident. No. <b>12</b></p> <b>3SE5 1...-LE01</b>  <p>Ident. No. <b>12</b></p>
<b>Twist levers<sup>1)</sup>, type A</b> <b>3SE5 1...-H0.</b>  <p>V<sub>max</sub> = 1.5 m/s                  Minimum torque in direction of operation: 0.25 Nm</p>	<b>Deflection in direction of rotation</b> <b>1 NO + 1 NC</b>  <p>Ident. No. <b>11</b></p> <b>3SE5 1...-BH01</b>  <p>Ident. No. <b>11</b></p> <b>1 NO + 2 NC</b>  <p>Ident. No. <b>12</b></p> <b>3SE5 1...-KH01</b>  <p>Ident. No. <b>12</b></p>	<b>Deflection in direction of rotation</b> <b>1 NO + 1 NC</b>  <p>Ident. No. <b>11</b></p> <b>3SE5 1...-CH01</b>  <p>Ident. No. <b>11</b></p> <b>1 NO + 2 NC</b>  <p>Ident. No. <b>12</b></p> <b>3SE5 1...-LH01</b>  <p>Ident. No. <b>12</b></p>
<b>Twist levers<sup>1)</sup>, adjustable length</b> <b>3SE5 1...-H6.</b>  <p>V<sub>max</sub> = 1.5 m/s                  Minimum torque in direction of operation: 0.25 Nm</p>	<b>Deflection in direction of rotation</b> <b>1 NO + 1 NC</b>  <p>Ident. No. <b>11</b></p> <b>3SE5 1...-BH60</b>  <p>Ident. No. <b>11</b></p> <b>1 NO + 2 NC</b>  <p>Ident. No. <b>12</b></p> <b>3SE5 1...-KA00 + head<sup>2)</sup></b>  <p>Ident. No. <b>12</b></p>	<b>Deflection in direction of rotation</b> <b>1 NO + 1 NC</b>  <p>Ident. No. <b>11</b></p> <b>3SE5 1...-CH60</b>  <p>Ident. No. <b>11</b></p> <b>1 NO + 2 NC</b>  <p>Ident. No. <b>12</b></p> <b>3SE5 1...-LH60</b>  <p>Ident. No. <b>12</b></p>
<b>Fork levers<sup>1)</sup></b> <b>3SE5 1...-T1.</b>  <p>V<sub>max</sub> = 1.5 m/s                  Minimum torque in direction of operation: 0.25 Nm</p>	The fork levers can be used only with snap-action contacts.	<b>Deflection in direction of rotation</b> <b>1 NO + 1 NC</b>  <p>Ident. No. <b>11</b></p> <b>3SE5 1...-CT11</b>  <p>Ident. No. <b>11</b></p> <b>1 NO + 2 NC</b>  <p>Ident. No. <b>12</b></p> <b>3SE5 1...-LA00 + head<sup>2)</sup></b>  <p>Ident. No. <b>12</b></p>

<sup>1)</sup> Adjustment of the lever in increments of 10°, maximum deflection 90°.

<sup>2)</sup> The basic switch and actuator head must be ordered separately.



# Limit Switches

## SIRIUS 3SE5 International Limit Switches

3SE5, metal enclosures  
Enclosure widths 40 mm and 56 mm

### Operation by bar (standard)

- Operating point acc. to EN 50041/47 (snap-action)
- \* Operating point on return (snap-action)
- ⊕ Positive opening acc. to EN 60947-5-1
- Direction of operation
- $v_{ma}$  Max. actuating speed

### Slow-action contacts

- Contact closed
- Contact open

### Snap-action contacts

- Contact closed
- Contact open

### Twist levers<sup>1)</sup>, adjustable length

#### 3SE5 1...-H5.

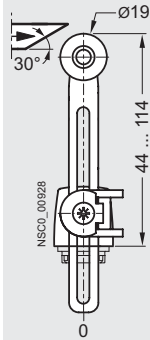

$v_{max} = 1.5 \text{ m/s}$   
Minimum torque  
in direction of operation: 0.25 Nm

#### 1 NO + 1 NC

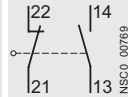

Ident. No. 11

### Deflection in direction of rotation

#### 3SE5 1...-BH50

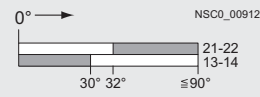

#### 1 NO + 1 NC

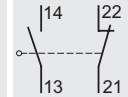

Ident. No. 11

### Deflection in direction of rotation

#### 3SE5 1...-CH50, -CH51

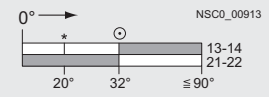

#### 1 NO + 2 NC

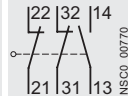

Ident. No. 12

#### 3SE5 1...-KA00 + head<sup>2)</sup>

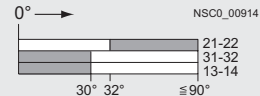

#### 1 NO + 2 NC

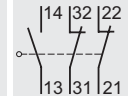

Ident. No. 12

#### 3SE5 1...-LH50

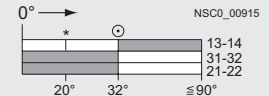

### Rod actuators<sup>1)</sup>, type D

#### 3SE5 1...-H8.

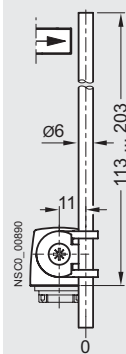

$v_{max} = 1.5 \text{ m/s}$   
Minimum torque  
in direction of operation: 0.25 Nm

#### 1 NO + 1 NC

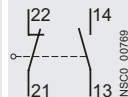

Ident. No. 11

### Deflection in direction of rotation

#### 3SE5 1...-BA00 + head<sup>2)</sup>

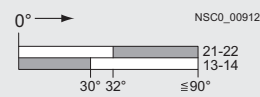

#### 1 NO + 1 NC

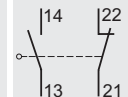

Ident. No. 11

### Deflection in direction of rotation

#### 3SE5 1...-CH80, -CH82

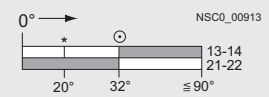

#### 1 NO + 2 NC

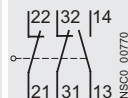

Ident. No. 12

#### 3SE5 1...-KA00 + head<sup>2)</sup>

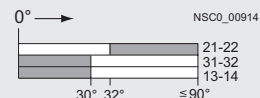

#### 1 NO + 2 NC

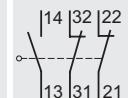

Ident. No. 12

#### 3SE5 1...-LA00 + head<sup>2)</sup>

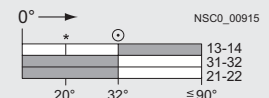

### Spring rods

#### 3SE5 1...-R0.

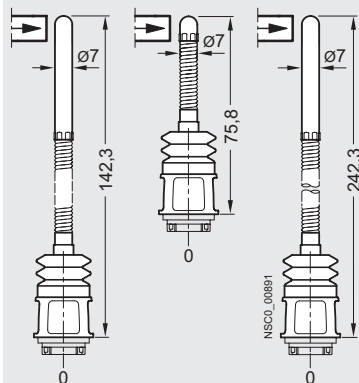

$v_{max} = 1 \text{ m/s}$   
Minimum force required  
in direction of operation: 9 N

The spring rods can be used only with snap-action contacts.

#### 1 NO + 1 NC

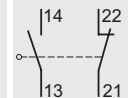

Ident. No. 11

### Deflection of spring rod

#### 3SE5 1...-CR01

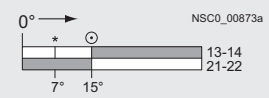

#### 1 NO + 2 NC

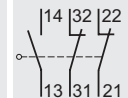

Ident. No. 12

#### 3SE5 1...-LA00 + head<sup>2)</sup>

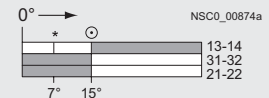

<sup>1)</sup> Adjustment of the lever in increments of 10°, maximum deflection 90°.

<sup>2)</sup> The basic switch and actuator head must be ordered separately.

# Limit Switches

## SIRIUS 3SE5 International Limit Switches

### Dimensional drawings

#### Dimensions of the basic switches

Enclosure width 31 mm, EN 50047, with M20 x 1.5 connecting thread 3SE5 232, 3SE5 212

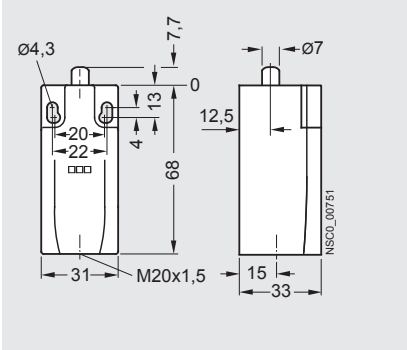

Enclosure width 31 mm, EN 50047, rear with fixing holes 3SE5 232, 3SE5 212

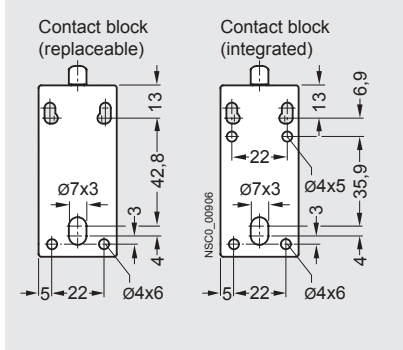

Enclosure width 31 mm, EN 50047, with M12 connector socket 3SE5 234, 3SE5 212

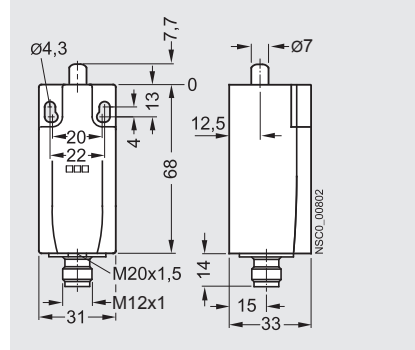

Enclosure width 50 mm, with M20 x 1.5 connecting thread 3SE5 242

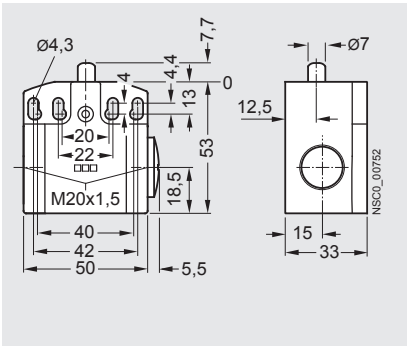

Enclosure width 50 mm, rear with fixing holes 3SE5 242

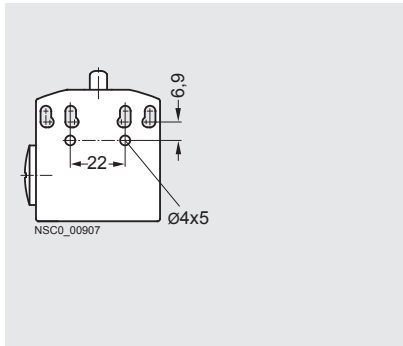

Enclosure width 40 mm, EN 50041, with M20 x 1.5 connecting thread 3SE5 112, 3SE5 132

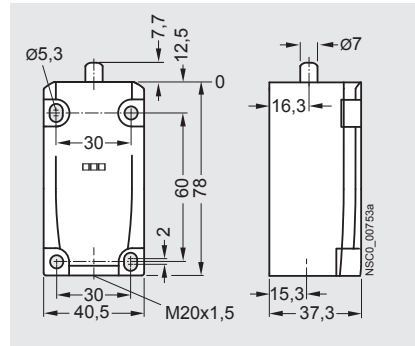

Enclosure width 40 mm, EN 50041, with 6-pole connector socket 3SE5 115

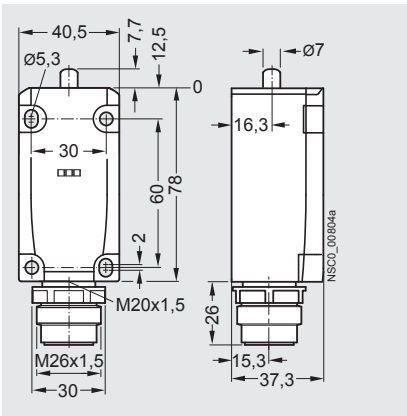

Enclosure width 56 mm, with M20 x 1.5 connecting thread 3SE5 122

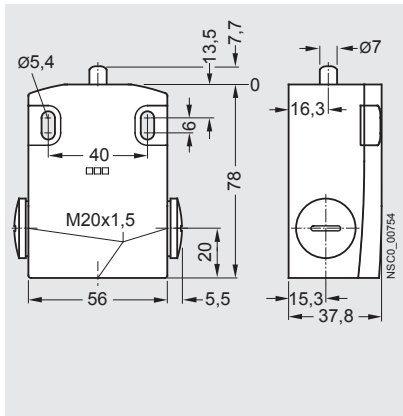

XL enclosure, width 56 mm, with M20 x 1.5 connecting thread 3SE5 162

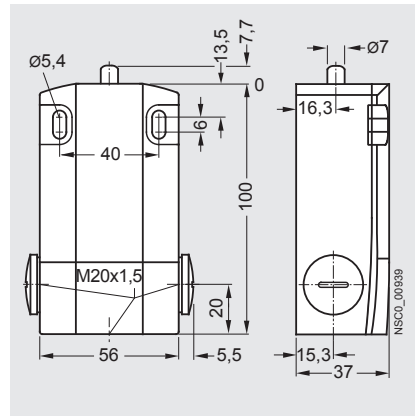

Operating mechanisms for basic switches, see pages 13/59 and 13/60.

# Limit Switches

## SIRIUS 3SE5 International Limit Switches

3SE5, open-type design

### Operating mechanisms for enclosure width 31 mm and 50 mm

Roller plunger, type C acc. to EN 50047

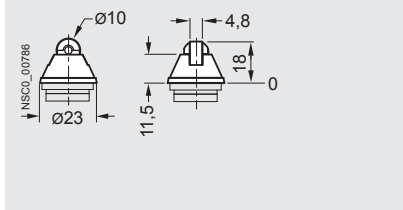

Roller plunger with central fixing

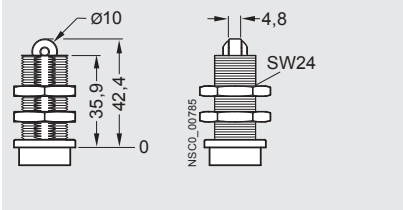

Roller lever, type E acc. to EN 50047

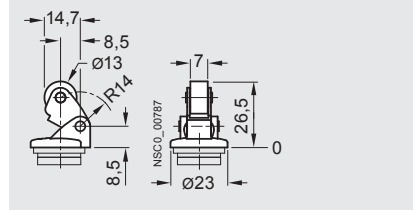

Angular roller lever

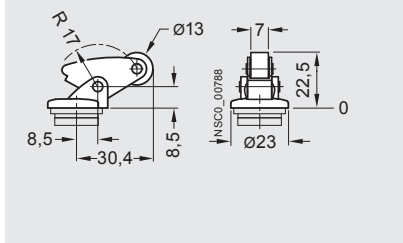

Twist lever, type A acc. to EN 50047

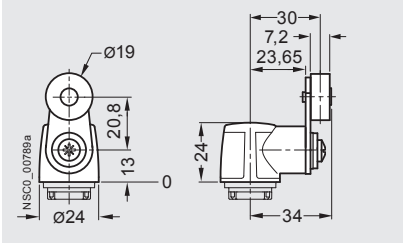

Twist lever, roller 30 mm

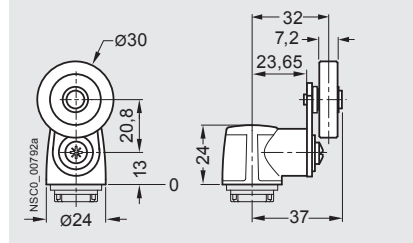

### Operating mechanism for enclosure width 40 mm and 56 mm

Plain plunger



Rounded plunger, type B acc. to EN 50041

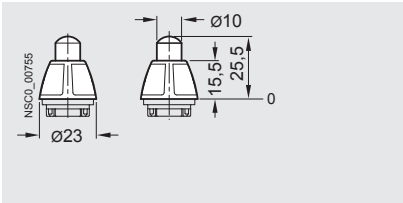

Roller plunger, type C acc. to EN 50041

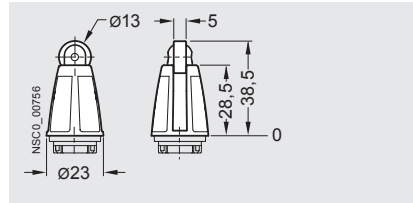

Roller lever

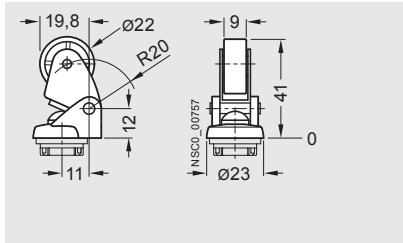

Angular roller lever

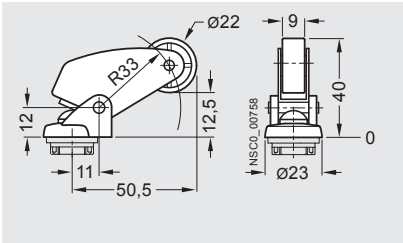

Twist lever, type A acc. to EN 50041

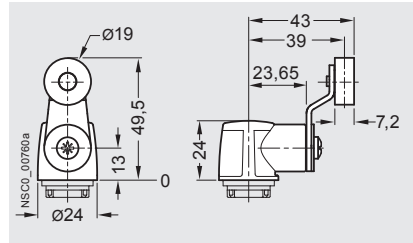

Twist lever, 2 rollers 19 mm

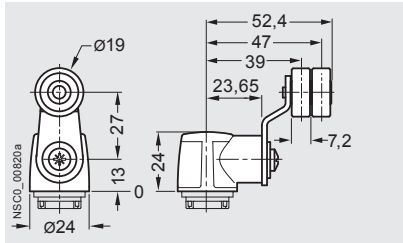

Fork lever, roller 19 mm

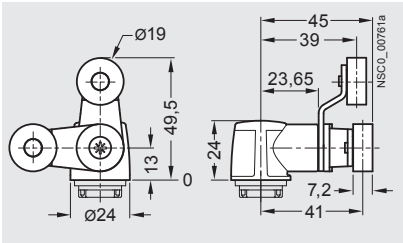

Twist lever, roller 30 mm

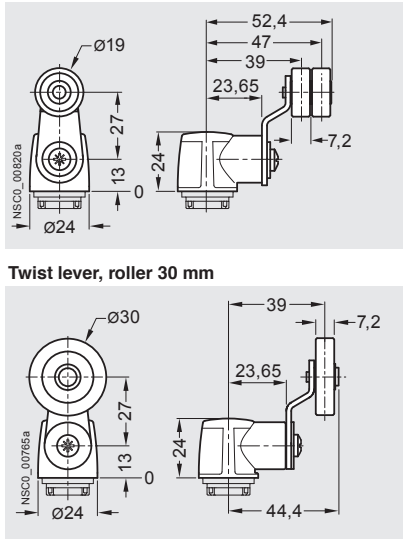

Twist lever, roller 50 mm

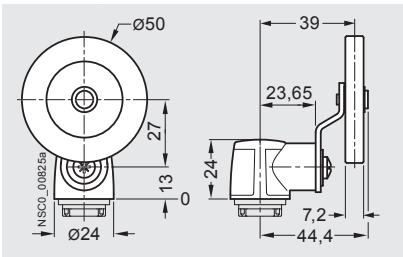

Twist lever, rubber roller 50 mm

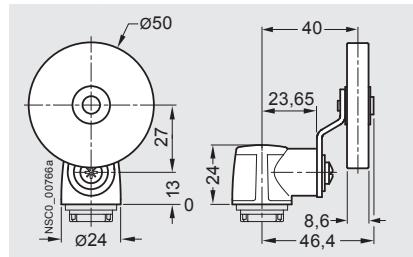

# Limit Switches

## SIRIUS 3SE5 International Limit Switches

### Dimensional drawings

#### Operating mechanisms for all enclosure widths

Twist lever, adjustable length, roller 19 mm

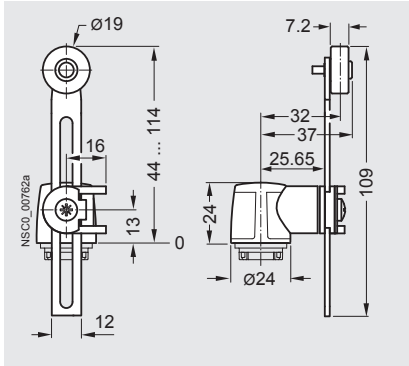

Twist lever, adjustable length, with grid hole, roller 19 mm

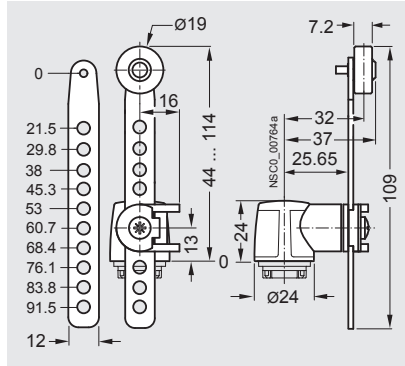

Twist lever, adjustable length, roller 30 mm

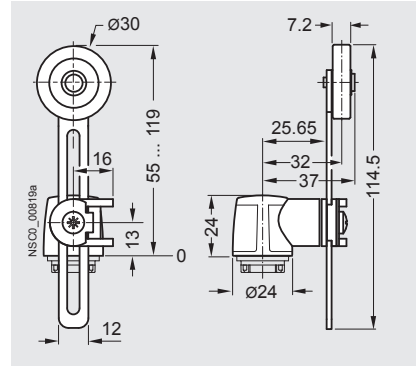

Twist lever, adjustable length, roller 50 mm

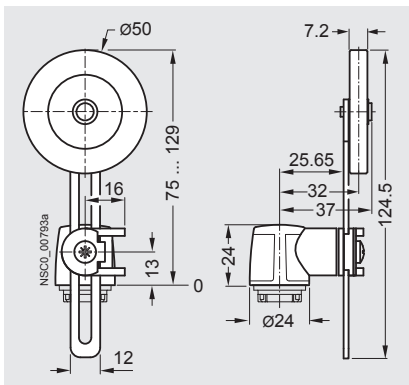

Twist lever, adjustable length, rubber roller 50 mm

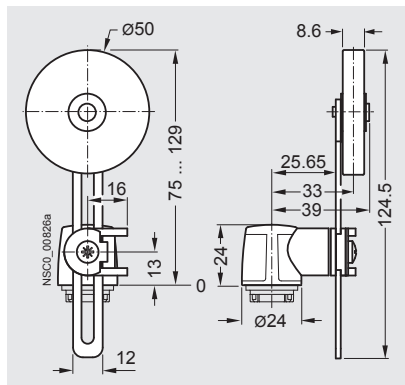

Twist lever, adjustable length, with grid hole, rubber roller 50 mm

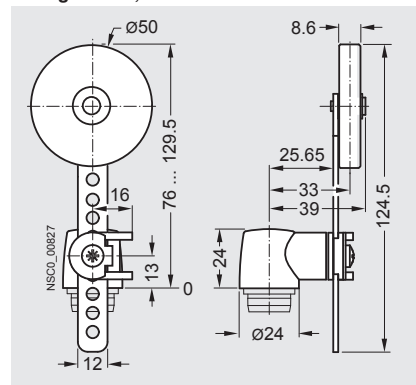

Rod actuator

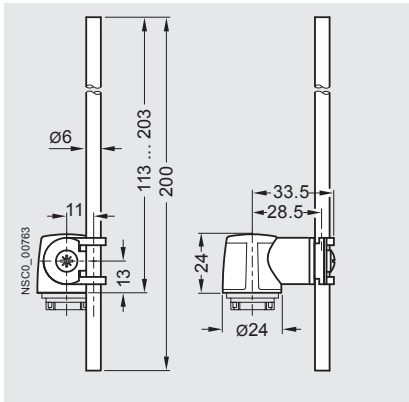

Spring rod, length 142.5 mm

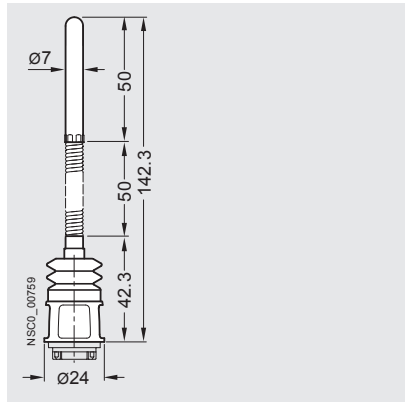

Spring rod, length 242.5 mm

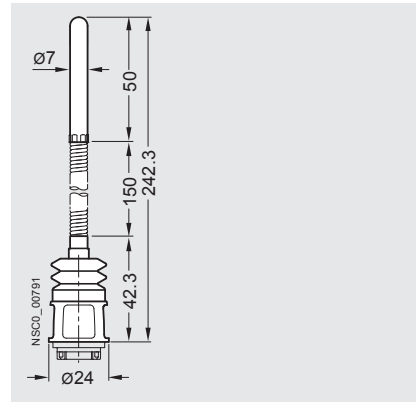

Spring rod, length 76 mm

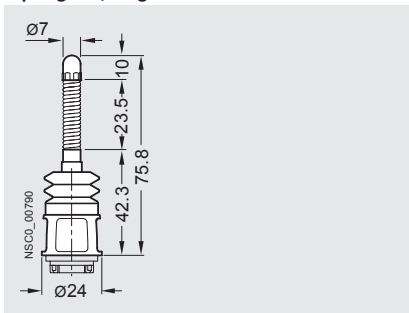

# Limit Switches

## SIRIUS 3SE5 International Limit Switches

### Dimensional drawings

#### Circuit diagrams

Enclosure widths 31, 40, 50 and 56 mm

**Slow-action contacts**  
1 NO + 1 NC  
3SE5 ...-B..., -R...

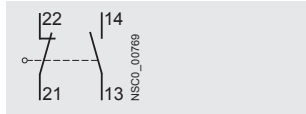

**Slow-action contacts**  
2 NO + 1 NC  
3SE5 ...-P...

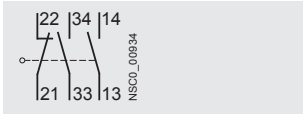

**Snap-action contacts**  
1 NO + 1 NC  
3SE5 ...-C..., -F..., -G..., -H..., -N...

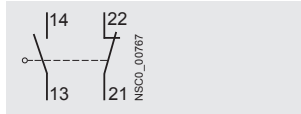

**Slow-action contacts**  
1 NO + 2 NC  
3SE5 ...-K..., -Q...

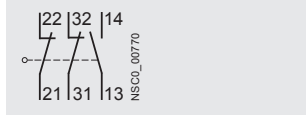

**Slow-action contacts**  
1 NO + 2 NC with make-before-break, 3SE5 ...-M...

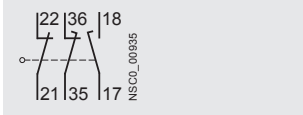

**Snap-action contacts**  
1 NO + 2 NC  
3SE5 ...-L...

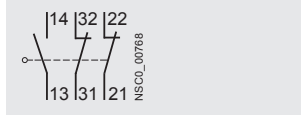

XL enclosures, width 56 mm

**Slow-action contacts**  
2 x (1 NO + 1 NC)  
3SE5 162-0B...

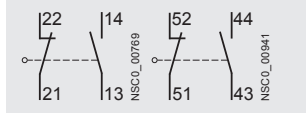

**Slow-action contacts**  
2 x (1 NO + 2 NC) with make-before-break, 3SE5 162-0D...

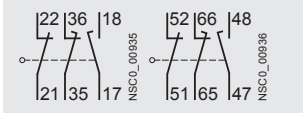

**For slow-action contacts**  
1 NO + 2 NC with make-before-break, 1 NO + 1 NC, 3SE5 162-0E...

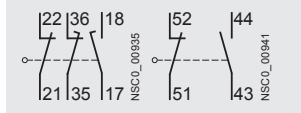

**Snap-action contacts**  
2 x (1 NO + 1 NC)  
3SE5 162-0C...

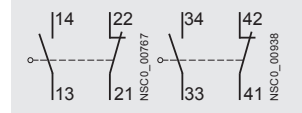

#### 3SE5 connector assignment

**M12 connector socket, 4-pole**  
3SY3 127

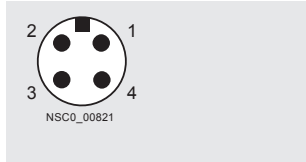

**M12 connector socket, 5-pole**  
3SY3 128

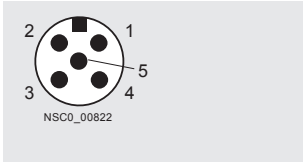

**M12 connector socket, 8-pole**  
3SY3 134

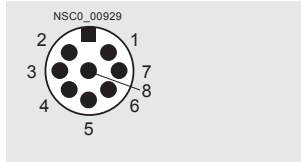

**Connector sockets, 6-pole + PE**  
3SY3 131

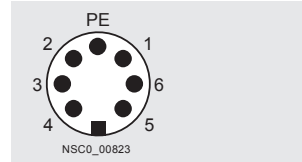

Order No.	Connector sockets		LEDs	Connections								
	Type	Version		Pin 1	Pin 2	Pin 3	Pin 4	Pin 5	Pin 6	Pin 7	Pin 8	PE
<b>M12 connector sockets (4-, 5- or 8-pole)</b>												
3SE5..4-0.....1AC4	3SY3 127	1 NO + 1 NC	—	21	22	13	14	—	—	—	—	—
3SE5..4-0.....1AC5	3SY3 128	1 NO + 1 NC	—	21	22	13	14	PE	—	—	—	—
3SE5..4-0.....1AE0	3SY3 127	2 NC	—	21	22	31	32	—	—	—	—	—
3SE5..4-0.....1AE1	3SY3 128	2 NC	—	21	22	31	32	PE	—	—	—	—
3SE5..4-1C....1AF3	3SY3 128	1 NO + 1 NC snap action	2 LEDs	21	22	13 / LED gn	14 / LED ye	Ground LED	—	—	—	—
3SE5..4-1B....1AF3	3SY3 128	1 NO + 1 NC slow-action	2 LEDs	21	22	14 / LED gn	13 / LED ye	Ground LED	—	—	—	—
3SE5..4-1L....1AD4	3SY3 134	1 NO + 2 NC snap action	2 LEDs	21	22	13 / LED gn	14 / LED ye	31	32	Ground LED	PE	—
3SE5..4-1K....1AD4	3SY3 134	1 NO + 2 NC slow-action	2 LEDs	21	22	14 / LED gn	13 / LED ye	31	32	Ground LED	PE	—
<b>Connector sockets, 6-pole + PE</b>												
3SE5..5-0.....1AD0	3SY3 131	1 NO + 1 NC	—	21	22	13	14	—	—	—	—	✓
3SE5..5-0.....1AD1	3SY3 131	1 NO + 2 NC	—	21	22	13	14	31	32	—	—	✓
3SE5..5-C....1AF2	3SY3 131	1 NO + 1 NC snap action	2 LEDs	21	22	13 / LED gn	14 / LED ye	—	Ground LED	—	—	✓
3SE5..5-B....1AF2	3SY3 131	1 NO + 1 NC slow-action	2 LEDs	21	22	14 / LED gn	13 / LED ye	—	Ground LED	—	—	✓
3SE5..5-L....1AD2	3SY3 131	2 NC snap-action	2 LEDs	21	22	31	32	13 / LED gn	Ground LED	—	—	✓
3SE5..5-K....1AD2	3SY3 131	2 NC slow-action	2 LEDs	21	22	31	32	14 / LED gn	Ground LED	—	—	✓

gn Green  
ye Yellow

✓ Connected  
— Not available

# Limit Switches

## 3SE03 North American Limit Switches

### General Information

#### Features

Modular plug-in



Prewired receptacle with pin connector



Prewired cable



#### Features

- UL Listed, CSA Certified.
- UL File: E47512
- All Metal Captive Screws.
- Keyed, Four-Directional Head.
- Steel-Reinforced Diaphragm Seal Between Operational Head And Switch Body.
- Permanent Instructions for Adjusting Operational Head.
- Modular, Plug-In Housing
  1. Heavy-Duty, Bifurcated, Plug-In Prongs.
  2. Ample Receptacle Wiring Space with 1/2 - NPT threaded conduit opening.
  3. Stepped Terminals On Single Pole; Deep Center Trough On Double Pole.
- NEMA Type 6P Submersible
  1. Completely Sealed With Epoxy.
  2. SOOW-A Cable or Prewired Receptacle With Pin Connector.
  3. Factory wired cable features a 350 pound pullput capacity.
- Rotary heads are field convertible CW, CCW, or both without special tools.

#### Design

##### Modular Plug-In Housing

These heavy duty plug-in limit switches may be provided as complete devices using a composite catalog number; or, separately as components; operating head, plug-in module and base receptacle.

##### Example:

Complete Switch:

##### 3SE03-AR1

Single Pole, Double Throw contacts with Side Rotary, Momentary Head

Components

##### 3SE03-SA<sup>⓪</sup>

Single Pole, Double Throw Plug-in Module

##### 3SE03-DR1

Side Rotary Head, Momentary

##### 3SE03-RA<sup>⓪</sup>

Standard, Single Pole Receptacle, 1 NO + 1 NC

Since components may be interchanged, operating heads, plug-in modules and receptacles may be combined to satisfy most of your everyday limit switch requirements. This leads to less inventory with greater flexibility.

Operating heads include side rotary; plain and roller plunger; and, wobble. A variety of levers are available.

The zinc die-cast housing has an epoxy finish to protect against corrosion. All screws on the module and head are captive.

#### NEMA Type 6P Submersible

These heavy duty prewired, factory sealed switches meet the demanding enclosure requirements of UL (NEMA) Type 3, 4, 4X, 6P, 12, and 13. They are intended for wet environments where the integrity of the threaded conduit and switch body seals must be assured.

The switch body cavity including threaded conduit entry is completely sealed with epoxy. An 8 foot, 5 or 9 conductor SOOW-A cable; or 5 or 9 pin prewired receptacle with pin connector is provided as standard.

Switches are provided as complete devices using composite catalog numbers; or, separately as components; operating head and switch body.

UL (NEMA) Type 6P switches are designed to provide a degree of protection against the entry of water during prolonged submersion at limited depths (tested with a 6 foot head of water for 24 hours).

Both the Modular Plug-in and the (NEMA) Type 6P Submersible styles provide 60 Amp make and 6 Amp break—120V AC and 10 Amp continuous current for 120, 240, 480 and 600V AC. The circuit contact configuration depends on the device selected and the application criteria.

Switches are available with momentary or maintained operating heads; and, single pole, double pole or center neutral (modular, plug-in only) contact configurations.

3SE03 limit switches offer a new standard of reliability and quality in automatic control circuits under heavy duty applications.

<sup>⓪</sup> Plug-in module and receptacle are keyed.

# Limit Switches

## 3SE03 North American Limit Switches

Modular, plug-in and  
NEMA type 6P submersible

1  
2  
3  
4  
5  
6  
7  
8  
9  
10  
11  
12  
13

### Technical data

Type	Modular, Plug-in and NEMA Type 6P Submersible					
<b>Mechanical life</b>	Side rotary: $13 \times 10^6$ make-break operations minimum All others: $10 \times 10^6$ make-break operations minimum					
<b>Electrical life</b>	Single Pole: $1 \times 10^6$ operations typical at full load Double Pole: $1 \times 10^5$ operations typical at full load					
<b>Switching frequency</b>	$8 \times 10^3$ make-break operations per hour (maximum)					
<b>Operating point accuracy</b>	Side operated: 0.0012 in. (modular, plug-in housing) Side rotary: 0.0014 in. (modular plug-in). Top operated: 0.0003 in. (modular, plug-in housing)					
<b>Cable entry</b>	1/2 in.-NPT, Prewired Cable or Prewired Receptacle with Pin Connector					
<b>Ambient temperature</b>	Without Cable: $-10^\circ$ to $+121^\circ\text{C}$ , $14^\circ$ to $250^\circ\text{F}$ With Cable: $-10^\circ$ to $+105^\circ\text{C}$ , $14^\circ$ to $221^\circ\text{F}$					
<b>Degree of protection</b>	NEMA Type 1, 3, 3S, 4, 4X, 6, 6P, 13; IP67					
<b>Conductor size</b>	22–12 AWG (modular, plug-in housing), single or stranded wire 5 or 9 conductor, 16 AWG yellow jacketed type SOOW-A cable (prewired cable) 5 or 9 pin, 0.87 in. (22 mm) diameter receptacle (prewired receptacle with pin connector)					
<b>Mounting</b>	Any position					
<b>Tightening Torque</b>	Switch body screws: 25–30 lb-in. Operating head screws: 14–18 lb-in.					
<b>NEMA rating</b>	<b>DC, NEMA R300</b>			<b>AC, NEMA A600</b>		
<b>Maximum current at</b>	<b>125V</b>	<b>250V</b>	<b>120V</b>	<b>240V</b>	<b>480V</b>	<b>600V</b>
<b>Make</b>	0.22A	0.11A	60A	30A	15A	12A
<b>Break</b>	0.22A	0.11A	6A	3A	1.5A	1.2A
<b>Max. volt-ampere</b>						
<b>Make</b>	28VA	28VA	7200VA	7200VA	7200VA	7200VA
<b>Break</b>	28VA	28VA	720VA	720VA	720VA	720VA
<b>Rated thermal current</b>	DC, 1A		AC, 10A			
<b>Rated operating voltage</b>	DC, 300V		AC, 600V			

### Operating temperature <sup>1) 2)</sup>

Temperature rating	Operation		Temperature range	
	Type	Return	Without cable	With cable
<b>1</b>	Side rotary <sup>3)</sup>	Momentary CW only or CCW only	$10^\circ\text{F}$ to $200^\circ\text{F}$ $-12^\circ\text{C}$ to $94^\circ\text{C}$	$10^\circ\text{F}$ to $200^\circ\text{F}$ $-12^\circ\text{C}$ to $94^\circ\text{C}$
<b>2</b>	Center neutral Side rotary Side plunger Two-sided plunger Roller side plunger <sup>4)</sup>	Momentary CW or CCW Maintained Momentary Maintained Momentary	$14^\circ\text{F}$ to $200^\circ\text{F}$ $-10^\circ\text{C}$ to $94^\circ\text{C}$	$14^\circ\text{F}$ to $200^\circ\text{F}$ $-10^\circ\text{C}$ to $94^\circ\text{C}$
<b>3</b>	Top plunger Top roller plunger <sup>4)</sup> Wobble head	Momentary Momentary Momentary	$14^\circ\text{F}$ to $250^\circ\text{F}$ $-10^\circ\text{C}$ to $121^\circ\text{C}$	$14^\circ\text{F}$ to $221^\circ\text{F}$ $-10^\circ\text{C}$ to $105^\circ\text{C}$

1) Temperature ranges below  $+32^\circ\text{F}$  ( $0^\circ\text{C}$ ) are based on absence of freezing moisture or water.

2) For temperature rating of specific switch, refer to page 13/70, Operating Heads.

3) For CW only or CCW only operation, upper temperature limit increases to  $250^\circ\text{F}$  ( $121^\circ\text{C}$ ) without cable, and  $221^\circ\text{F}$  ( $105^\circ\text{C}$ ) with pre-wired cable.











4) Roller direction can be converted in the field.

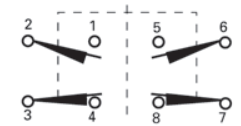



# Limit Switches

## 3SE03 North American Limit Switches

Modular, plug-in metal housing

### Complete switches without lever - threaded cable entry:

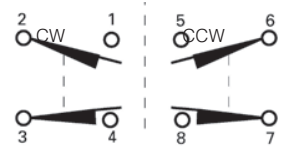
	<b>Plug-In module type</b>	Standard single pole 1 NO + 1 NC (3SE03-SA)	Standard double pole 2 NO + 2 NC (3SE03-SB)				
	<b>Receptacle type surface mount</b>	Single pole (3SE03-RA) 	Double pole (3SE03-RB) 				
<b>Composite catalog number consisting of head, module and receptacle</b>							
<b>Operating head type</b>		<b>DT</b>	<b>Catalog Number</b>	<b>List Price \$ 1 unit</b>	<b>DT</b>	<b>Catalog Number</b>	<b>List Price \$ 1 unit</b>
	<b>Side rotary</b> CW and CCW operation convertible to CW only or CCW only	Standard momentary (3SE03-DR1)	▶ 3SE03-AR1 <sup>①</sup>		▶ 3SE03-BR1 <sup>①</sup>		
		Standard maintained (3SE03-DM1)	▶ 3SE03-AM1		▶ 3SE03-BM1		
		Low torqued momentary (3SE03-DL1)	▶ 3SE03-AL1 <sup>②</sup>		3SE03-BL1 <sup>②</sup>		
	<b>Plain side plunger</b>	Momentary (3SE03-DS1)	▶ 3SE03-AS1		▶ 3SE03-BS1		
	<b>Roller side plunger</b>	Momentary (3SE03-DS3)	▶ 3SE03-AS3		3SE03-BS3		
	<b>Two-sided plunger</b>	Maintained (3SE03-DH1)		3SE03-AH1		3SE03-BH1	
	<b>Plain top plunger</b>	Momentary (3SE03-DT1)	▶ 3SE03-AT1		3SE03-BT1		
	<b>Roller top plunger</b>	Momentary (3SE03-DT3)		3SE03-AT3	▶ 3SE03-BT3		
	<b>Wobble head (without lever)</b>	Momentary (3SE03-DW1)	▶ 3SE03-AW1		▶ 3SE03-BW1		

	<b>Plug-In module type</b>	Center neutral Double pole 2 NO + 2 NC (3SE03-SN)		
	<b>Receptacle type surface mount</b>	Center neutral (3SE03-RB) 		
<b>Composite catalog number consisting of head, module and receptacle</b>				
<b>Operating head type</b>		<b>DT</b>	<b>Catalog Number</b>	<b>List Price \$ 1 unit</b>
	<b>Side rotary (momentary)</b>	Center (3SE03-DN1)	▶ 3SE03-NN1 <sup>①</sup>	
		Neutral (3SE03-DN2)	▶ 3SE03-NN2 <sup>②</sup>	

① 5° pretravel to operate contacts.

② 15° pretravel to operate contacts.











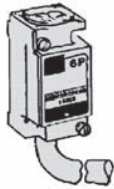

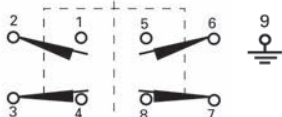
# Limit Switches

## 3SE03 North American Limit Switches

NEMA type 6P submersible, prewired cable

### Complete switches without lever - prewired cable:

 <p>Switch body type—prewired cable with 8 foot cable</p>	<p>Single pole 1 NO + 1 NC (3SE03-SA6P)</p> <p>Cable color code 1 - White 2 - Black 3 - Red 4 - Orange 5 - Green</p>	<p>Double pole 2 NO + 2 NC (3SE03-SB6P)</p> <p>Cable color code 1 - White      6 - Pink 2 - Black      7 - Yellow 3 - Red        8 - Blue 4 - Orange     9 - Green 5 - Brown</p>
		

Operating head type		Composite catalog number consisting of head and switch body				
		DT	Catalog Number	List Price \$ 1 unit	Catalog Number	List Price \$ 1 unit
 <p><b>Side rotary</b> CW and CCW operation convertible to CW only or CCW only</p>	Standard momentary (3SE03-DR1)	▶	3SE03-AR16P		3SE03-BR16P	
	Standard maintained (3SE03-DM1)		3SE03-AM16P		3SE03-BM16P	
	Low torqued momentary (3SE03-DL1)		3SE03-AL16P		3SE03-BL16P	
 <p><b>Plain side plunger</b></p>	Momentary (3SE03-DS1)		3SE03-AS16P		3SE03-BS16P	
 <p><b>Roller side plunger</b></p>	Momentary (3SE03-DS3)		3SE03-AS36P		3SE03-BS36P	
 <p><b>Two-sided plunger</b></p>	Maintained (3SE03-DH1)		3SE03-AH16P		Not available	
 <p><b>Plain top plunger</b></p>	Momentary (3SE03-DT1)		3SE03-AT16P		3SE03-BT16P	
 <p><b>Roller top plunger</b></p>	Momentary (3SE03-DT3)		3SE03-AT36P		3SE03-BT36P	
 <p><b>Wobble head (without lever)</b></p>	Momentary (3SE03-DW1)		3SE03-AW16P		3SE03-BW16P	





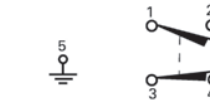
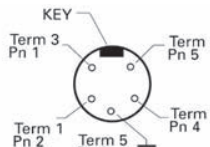
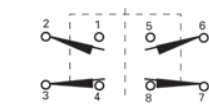
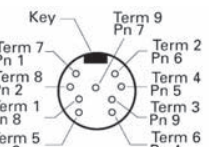

# Limit Switches

## 3SE03 North American Limit Switches

**NEMA type 6P submersible,  
prewired receptacle**

**Complete switches without lever - prewired receptacle with pin connector:**

 <p>Switch Body Type—prewired receptacle with pin connector</p>	<p>Single pole 1 NO + 1 NC (3SE03-SA6PC)</p>  	<p>Double pole 2 NO + 2 NC (3SE03-SB6PC)</p>  
--	--	--



Operating head type		Composite catalog number consisting of head and switch body				
		DT	Catalog Number	List Price \$ 1 unit	Catalog Number	List Price \$ 1 unit
 <p><b>Side rotary</b> CW and CCW operation convertible to CW only or CCW only</p>	Standard momentary (3SE03-DR1)	▶	3SE03-AR16PC		3SE03-BR16PC	
	Standard maintained (3SE03-DM1)		3SE03-AM16PC		3SE03-BM16PC	
	Low torqued momentary (3SE03-DL1)		3SE03-AL16PC		3SE03-BL16PC	
 <p><b>Plain side plunger</b></p>	Momentary (3SE03-DS1)		3SE03-AS16PC		3SE03-BS16PC	
 <p><b>Roller side plunger</b></p>	Momentary (3SE03-DS3)		3SE03-AS36PC		3SE03-BS36PC	
 <p><b>Two-sided plunger</b></p>	Maintained (3SE03-DH1)		3SE03-AH16PC		Not available	
 <p><b>Plain top plunger</b></p>	Momentary (3SE03-DT1)		3SE03-AT16PC		3SE03-BT16PC	
 <p><b>Roller top plunger</b></p>	Momentary (3SE03-DT3)		3SE03-AT36PC		3SE03-BT36PC	
 <p><b>Wobble head (without lever)</b></p>	Momentary (3SE03-DW1)		3SE03-AW16PC		3SE03-BW16PC	

# Limit Switches



## 3SE03 North American Limit Switches

Modular, plug-in and  
NEMA type 6P submersible









### Components:

 <b>Plug-in module</b>	<b>Plug-in module</b>	<b>DT</b>	<b>Catalog Number</b>	<b>List Price \$ 1 unit</b>
	Standard single pole 1 NO + 1 NC	▶	3SE03-SA	
	Standard double pole 2 NO + 2 NC	▶	3SE03-SB	
	Center neutral 2 NO + 2 NC <sup>①</sup>	▶	3SE03-SN	
 <b>Receptacle</b>	<b>Receptacle for plug-in module</b>		<b>Catalog Number</b>	<b>List Price \$ 1 unit</b>
	Single pole 1 NO + 1 NC (5 terminals)	▶	3SE03-RA	
	Single pole 2 NO + 2 NC (9 terminals)		3SE03-RB	

### Switch body—NEMA type 6P submersible:

 <b>Prewired cable</b>	<b>Switch body</b>	<b>Prewired cable 8 foot length</b>			<b>Prewired receptacle with pin connector</b>		
		<b>DT</b>	<b>Catalog Number</b>	<b>List Price \$ 1 unit</b>	<b>DT</b>	<b>Catalog Number</b>	<b>List Price \$ 1 unit</b>
 <b>Prewired receptacle</b>	Single pole 1 NO + 1 NC	▶	3SE03-SA6P			—	—
	Single pole 2 NO + 2 NC	▶	3SE03-SB6P			—	—
	Single pole 1 NO + 1 NC		—	—	▶	3SE03-SA6PC	
	Single pole 2 NO + 2 NC		—	—	▶	3SE03-SB6PC	

### Operating heads<sup>②</sup>:

 <b>Operating head type</b>		<b>Nominal operating data</b>								
		<b>Total travel</b>	<b>Pretravel</b>	<b>Operating force</b>	<b>Release position</b>	<b>Minimum return force</b>	<b>Operating temp range<sup>④</sup></b>	<b>DT</b>	<b>Catalog Number</b>	<b>List Price \$ 1 unit</b>
 <b>Side rotary<sup>⑤</sup></b>	Standard momentary <sup>⑥</sup>	90°	5°	3 lb-in.	2°	4.5 oz-in.	1	▶	3SE03-DR1	
	Low torqued momentary <sup>⑥</sup>	90°	15°	1.5 lb-in.	6°	2.5 oz-in.	1	▶	3SE03-DL1	
	Standard maintained	90°	50°	3 lb-in.	50°	—	—	2	▶	3SE03-DM1
 <b>Plain side plunger</b>	Momentary	0.25 in.	0.065 in.	4 lbs	0.03 in.	8 oz.	2	▶	3SE03-DS1	
 <b>Roller side plunger</b>	Momentary <sup>⑦</sup>	0.25 in.	0.065 in.	4 lbs	0.03 in.	8 oz.	2	▶	3SE03-DS3	
 <b>Two-sided plunger</b>	Maintained	0.32 in.	0.2 in.	5 lbs	0.13 in.	5 lbs	2	▶	3SE03-DH1	
 <b>Plain top plunger</b>	Momentary	0.28 in.	0.04 in.	4 lbs	0.02 in.	8 oz.	3	▶	3SE03-DT1	
 <b>Roller top plunger</b>	Momentary	0.28 in.	0.04 in.	4 lbs	0.02 in.	8 oz.	3	▶	3SE03-DT3	
 <b>Wobble head<sup>⑧</sup></b>	Momentary	15°	10°	2 lb-in.	6°	2.4 oz-in.	3	▶	3SE03-DW1	
 <b>Center neutral<sup>⑨</sup></b>	Momentary	90°	5°	1.8 lb-in.	2°	2.5 oz-in.	2	▶	3SE03-DN1	
		90°	15°	1.8 lb-in.	2°	2.5 oz-in.	2	▶	3SE03-DN2	

<sup>①</sup> For use with 3SE03-DN1, -DN2 operating heads and 3SE03-RB receptacle only.

<sup>②</sup> For use with modular, Plug-in and NEMA Type 6P.

<sup>③</sup>

<sup>④</sup> Refer to "Operating Temperature", Catalog page 13/118 for Temperature Ranges.

<sup>⑤</sup> Without Operating Levers.

<sup>⑥</sup> CW and CCW operation. Convertible to CW or CCW operation only.

<sup>⑦</sup> Convertible—Horizontal to Vertical.

<sup>⑧</sup> Requires Lever.





<sup>⑨</sup> For use with 3SE03-SN plug-in module only.

# Limit Switches

## 3SE03 North American Limit Switches

Modular, plug-in metal housing

### Levers for plug-in and non-plug-in versions—most widely used

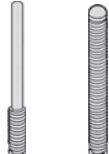
Description	Length <sup>①</sup>	Roller mounted on side of lever	Roller material	Roller diameter	Roller face width	Max required <sup>②</sup> return torque (oz-in.)	DT	Catalog Number	List Price \$ 1 unit
	1.5 (38)	Front	Nylatron	0.75 (19)	0.31 (8)	0.53	▶	3SX03-KL200	
	1.5 (38)	Front	Cast aluminum	0.75 (19)	0.31 (8)	1.10	▶	3SX03-KL355	
	1.5 (38)	Back	Cast aluminum	0.75 (19)	0.31 (8)	1.10	▶	3SX03-KL579	
	1.5 (38)	Back / back	Nylatron	0.75 (19)	0.31	-	▶	3SX03-KL204	
	1-3.5 (25-89)	Front	Nylatron	0.75 (19)	0.31 (8)	1.90 <sup>⑤</sup>	▶	3SX03-KL201	
	1-3.5 (25-89)	Front	Metal	0.75 (19)	0.31 (8)	3.40 <sup>⑤</sup>	▶	3SX03-KL538	
	9 (229)	-	Stainless steel	-	-	7.00 <sup>⑤</sup>	▶	3SX03-KL220	
	Adjustable spring rod	12.125 (308)	-	Nylon	-	-	3.50 <sup>⑤</sup>	▶	3SX03-KL556
	6 (152)	-	Nylatron	-	-	0.40	▶	3SX03-KL142	
<b>Levers</b>									
	Rod	-	-	Nylon	-	-	▶	3SX03-KW2	
	Coil spring	-	-	Coil spring	-	-	▶	3SX03-KW4	
	For plunger actuated switches wobble actuators	⑥							

### Levers for plug-in and non-plug-in versions:

Operator	Length <sup>①</sup>	Roller			Max required <sup>②</sup> return torque (oz-in.)	Catalog Number			List Price \$ 1 unit
		Type	Diameter	Face (width)		Stainless steel	DT	Cast aluminum	
	0.87 (22)	Metal	0.75 (19)	0.31 (8)	0.62	-		3SX03-KL39	
	1.37 (35)	Metal	0.75 (19)	0.31 (8)	0.95	-	▶	3SX03-KL40	
	1.50 (38)	Nylatron	0.75 (19)	1.00 (25)	0.92	-	▶	3SX03-KL337	
		Ball bearing	0.69 (17)	0.25 (6)	0.77	-		3SX03-KL531	
		Without roller	-	-	0.32	-		3SX03-KL32	
	2.00 (51)	Nylatron	0.75 (19)	0.31 (8)	0.71	-	▶	3SX03-KL546	
Nylatron		0.75 (19)	1.00 (25)	1.45	-		3SX03-KL572		
Metal		0.75 (19)	0.31 (8)	1.5	-	▶	3SX03-KL549		
250 (64)	Ball bearing	0.69 (17)	0.25 (6)	1.1	-		3SX03-KL552		
	Nylatron	0.75 (19)	0.31 (8)	1.0	-		3SX03-KL547		
	Nylatron	0.75 (19)	1.00 (25)	1.8	-		3SX03-KL573		
	Nylatron	1.5 (38)	0.28 (7)	1.4	-		3SX03-KL575		
	Metal	0.75 (19)	0.31 (8)	2.0	-		3SX03-KL550		
Cast aluminum	Ball bearing	0.69 (17)	0.25 (6)	1.5	-	▶	3SX03-KL553		
	Nylatron	0.75 (19)	0.31 (8)	1.3	-	▶	3SX03-KL548		
	Nylatron	0.75 (19)	1.00 (25)	2.3	-	▶	3SX03-KL574		
	Nylatron	1.5 (38)	0.28 (7)	1.8	-	▶	3SX03-KL576		
	Metal	0.75 (19)	0.31 (8)	2.5	-	▶	3SX03-KL551		
3.00 (76)	Ball bearing	0.69 (17)	0.25 (6)	1.8	-		3SX03-KL554		

All dimensions shown in inches and (millimeters). For reference purposes only. Not to be used for design or construction purposes.

① Roller lever: Length from the operating shaft axis to the roller axis.  
All other: Length from the operating shaft axis to the tip.

② Caution—When selecting lever, required return torque should not exceed minimum return torque in operating head.

③ Cap screw accommodates 3/64 inch Allen wrench.  
④ By re-assembling lever minimum can be reduced another 0.50 (13).

⑤ Applies when lever extended to maximum dimension.

⑥ See dimensions page 13/76.







# Limit Switches

## 3SE03 North American Limit Switches

Modular, plug-in and  
NEMA type 6P submersible

1  
2  
3  
4  
5  
6  
7  
8  
9  
10  
11  
12  
13

### Levers for plug-in and non-plug-in versions—most widely used

Operator	Length <sup>①</sup> Inches (mm)	Roller			Min. required return torque oz-in <sup>⑤</sup>	Catalog Number				
		Type	Diameter In. (mm)	Face width in. (mm)		DT	Stainless steel	Cast aluminum	List Price \$ 1 unit	
<b>Roller levers</b>										
	Roller on reverse side	1.50 (38)	Nylatron	0.75 (19)	0.31 (8)	0.53	▶	–	3SX03-KL310	
			Nylatron	1.5 (38)	0.28 (7)	0.96	–	–	3SX03-KL536	
			Ball bearing	0.69 (17)	0.25 (6)	0.77	–	–	3SX03-KL580	
	Offset lever (Inboard roller shown)	1.50 (38)	Inboard roller	Nylatron	0.75 (19)	0.31 (8)	0.65	▶	3SX03-KL24	–
				Metal	0.75 (19)	0.31 (8)	1.20	▶	3SX03-KL25	–
				Ball bearing	0.69 (17)	0.25 (6)	0.90	▶	3SX03-KL26	–
		1.50 (38)	outboard roller	Nylatron	0.75 (19)	0.31 (8)	0.65	▶	3SX03-KL27	–
				Metal	0.75 (19)	0.31 (8)	1.20	▶	3SX03-KL28	–
				Ball bearing	0.69 (17)	0.25 (6)	0.90	▶	3SX03-KL29	–
Nylatron	0.75 (19)	1 (25)	1.10	▶	3SX03-KL30	–				
	Bantam lever	0.69 (18)	Metal	0.88 (22)	0.19 (5)	0.45	▶	3SX03-KL532		
	Precision adjustment	1.50 (38) <sup>②</sup>	Nylatron	0.75 (19)	0.31 (8)	0.65	–	3SX03-KL340		
			Metal	0.75 (19)	0.31 (8)	1.20	–	3SX03-KL465		
			Ball bearing	0.69 (17)	0.25 (6)	0.90	▶	3SX03-KL535		
	Adjustable roller	1–3.75 (25–95) <sup>③</sup> 1–3.75 (25–95) <sup>③</sup> 1.62–3.75 (41–95) <sup>③</sup> 0.50–3.75 (13–95) 1–3.75 (25–95) <sup>③</sup> 0.50–3.75 (13–95)	Nylatron	0.75 (19)	0.5 (13)	1.90 <sup>④</sup>	▶	3SX03-KL599		
			Nylatron	0.75 (19)	1 (25)	3.10 <sup>④</sup>	▶	3SX03-KL537		
			Nylatron	1.5 (38)	0.28 (7)	2.50 <sup>④</sup>	▶	3SX03-KL443		
			Large nylatron	4 (102)	0.11 (3)	4.50 <sup>④</sup>	▶	3SX03-KL598		
			Ball bearing	0.69 (17)	0.25 (6)	2.50 <sup>④</sup>	▶	3SX03-KL539		
			Without roller	–	–	1.20 <sup>④</sup>	▶	3SX03-KL31		
	Fork lever _ both rollers one side	1.50 (38)	Nylatron	0.75 (19)	1 (25)	–	▶	3SX03-KL543		
			Metal	0.75 (19)	0.31 (8)	–	▶	3SX03-KL544		
			Ball bearing	0.69 (17)	0.25 (6)	–	▶	3SX03-KL545		
	Fork lever _ both rollers outside, one side	1.50 (38)	Nylatron	0.75 (19)	0.31 (8)	–	▶	3SX03-KL203		
			Metal	0.75 (19)	0.31 (8)	–	▶	3SX03-KL541		
			Ball bearing	0.69 (17)	0.25 (6)	–	▶	3SX03-KL542		

### Levers for plug-in and non-plug-in versions:

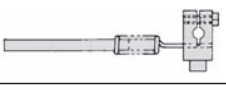
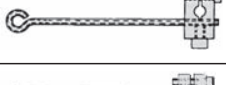
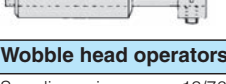
Operator		Length <sup>①</sup> Inches (mm)	Description Inches (mm)	Min. required return force oz-in. <sup>⑤</sup>	DT	Catalog Number	List Price \$ 1 unit
	Adjustable rod	5.50 (140) Max.	Nylon Rod—0.19 (5) Dia.	0.40 <sup>④</sup>	▶	3SX03-KL399	
		5.50 (140) Max.	Metal Rod—0.12 (3) Dia.	0.92 <sup>④</sup>	▶	3SX03-KL202	
		8.75 (222) Max.	Metal Rod (Square)—0.12 (3) Max.	2.20 <sup>④</sup>	▶	3SX03-KL581	
		12 (305) Max.	Steel (Formable) Rod—0.12 (3) Dia.	5.00 <sup>④</sup>	▶	3SX03-KL226	
		–	Clamp Only—0.19 (5) Hole	–	▶	3SX03-KL35	
		–	Clamp Only—0.12 (3) Hole	–	▶	3SX03-KL36	
	Spring rod	11.62 (295)	Metal rod	2.80		3SX03-KL421	
	Adjustable wire	12.12 (308) max.	Nylon covered wire	1.50 <sup>④</sup>	▶	3SX03-KL533	
	Adjustable wide roller lever	3.9 (99)	0.75 (19) Dia. Nylatron Roller 0.19 (30) Dia. Rod	4.50 <sup>④</sup>	▶	3SX03-KL37	
<b>Wobble head operators</b>							
See dimensions page 13/76	Stainless steel rod	–	Rod diameter - 0.06 (2)	–	▶	3SX03-KW3	

① Length from operating shaft axis to the roller axis.

② Maximum dimensions, precision adjustable to lesser dimensions.

③ By re-assembling lever minimum can be reduced by 1/2 in.

④ Applies when lever extended to maximum dimension.

⑤ Caution—When selecting lever, required return torque should not exceed minimum return force in operating head.

All dimensions shown in inches and (millimeters). For reference purposes only. Not to be used for design or construction purposes.

# Limit Switches

## 3SE03 North American Limit Switches

Modular, plug-in and  
NEMA type 6P submersible

### Wiring diagrams

Single Pole  
1 NO - 1 NC

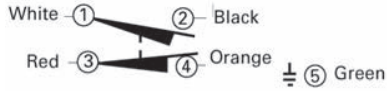

Double Pole  
1 NO - 1 NC

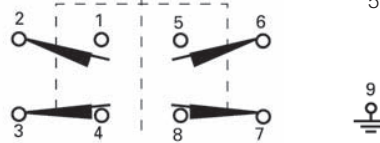

Cable color code  
1 - White 6 - Pink  
2 - Black 7 - Yellow  
3 - Red 8 - Blue  
4 - Orange 9 - Green  
5 - Brown  
Pre-wired cable

### Modular, plug-in and prewired cable

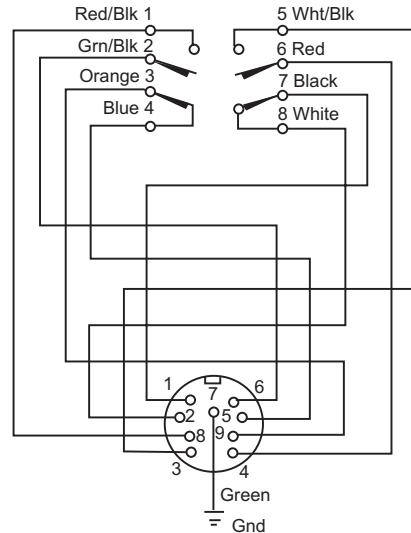
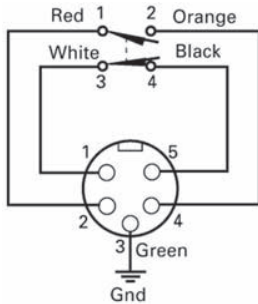

### Prewired receptacle with pin connector

#### Typical connector cable (supplied by user)

Cable length ft.	Manufacturers part number			
	Daniel Woodhead Brad Harrison	Cooper Crouse-Hinds	Molex (Industrial Interface)	Lumberg USA
<b>5 Pin connector cable</b>				
3	105000A01F030	5000111-3_	14541	RK50-77/1M
6	105000A01F060	5000111-4_	14542	RK50-77/2M
12	105000A01F120	5000111-5_	14544	RK50-77/4M
<b>9 Pin connector cable</b>				
3	309000A01F030	X8990-3	-	-
6	309000A01F060	X8990-4	-	-
12	309000A01F120	X8990-5	-	-

# Limit Switches

## 3SE03 North American Limit Switches

Modular, plug-in and  
NEMA type 6P submersible

1

2

3

4

5

6

7

8

9

10

11

12

13

### Dimension drawings

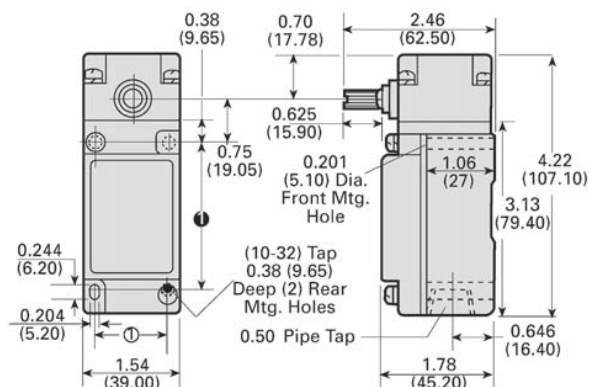

Plain side plunger

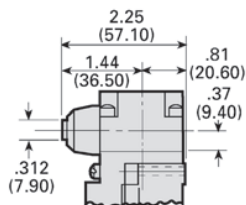

Roller side plunger

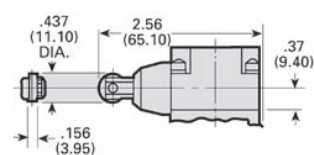

Two side plungers

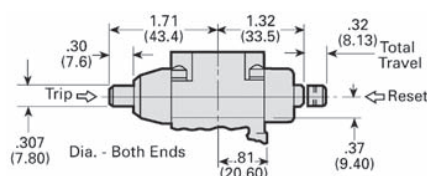

Plain top plunger

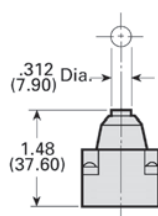

Roller top plunger

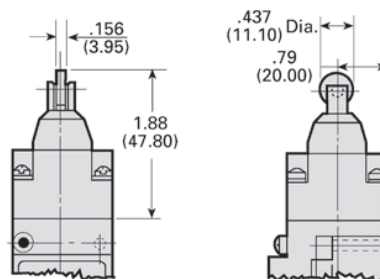

### Rotary lever operators

Catalog Number	Dimensions						Catalog Number	Dimensions					
	A	B	C	D	E	F		A	B	C	D	E	F
3SX03-KL200	1.50 (38.1)	0.75 (19.0)	0.32 (8.1)	0.44 (11.2)	0.20 (5.1)	0.24 (6.1)	3SX03-KL554	3.00 (76.2)	0.688 (17.5)	0.25 (6.4)	0.42 (10.7)	0.12 (3.0)	0.18 (4.6)
3SX03-KL355	1.50 (38.1)	0.75 (19.0)	0.32 (8.1)	0.44 (11.2)	0.20 (5.1)	0.24 (6.1)	3SX03-KL572	2.00 (50.8)	0.75 (19.0)	1.00 (25.4)	0.42 (10.7)	0.90 (22.9)	0.90 (22.9)
3SX03-KL377	1.50 (38.1)	0.75 (19.0)	1.00 (25.4)	0.44 (11.2)	0.90 (22.9)	0.90 (22.9)	3SX03-KL573	2.50 (63.5)	0.75 (19.0)	1.00 (25.4)	0.42 (10.7)	0.90 (22.9)	0.90 (22.9)
3SX03-KL531	1.50 (38.1)	0.688 (17.5)	0.25 (6.4)	0.44 (11.2)	0.12 (3.0)	0.18 (4.6)	3SX03-KL574	3.00 (76.2)	0.75 (19.0)	1.00 (25.4)	0.42 (10.7)	0.90 (22.9)	0.90 (22.9)
3SX03-KL546	2.00 (50.8)	0.75 (19.0)	0.32 (8.1)	0.42 (10.7)	0.20 (5.1)	0.24 (6.1)	3SX03-KL575	2.50 (63.5)	1.50 (38.1)	0.29 (7.4)	0.42 (10.7)	0.18 (4.6)	0.24 (6.1)
3SX03-KL547	2.50 (63.5)	0.75 (19.0)	0.32 (8.1)	0.42 (10.7)	0.20 (5.1)	0.24 (6.1)	3SX03-KL576	3.00 (76.2)	1.50 (38.1)	0.29 (7.4)	0.42 (10.7)	0.18 (4.6)	0.24 (6.1)
3SX03-KL548	3.00 (76.2)	0.75 (19.0)	0.32 (8.1)	0.42 (10.7)	0.20 (5.1)	0.24 (6.1)	<b>With rollers on reverse side</b>						
3SX03-KL549	2.00 (50.8)	0.75 (19.0)	0.32 (8.1)	0.42 (10.7)	0.20 (5.1)	0.24 (6.1)	3SX03-KL310	1.50 (38.1)	0.75 (19.0)	0.32 (8.1)	0.44 (11.2)	0.34 (8.6)	0.38 (9.7)
3SX03-KL550	2.50 (63.5)	0.75 (19.0)	0.32 (8.1)	0.42 (10.7)	0.20 (5.1)	0.24 (6.1)	3SX03-KL536	1.50 (38.1)	1.50 (38.1)	0.28 (7.1)	0.44 (11.2)	0.30 (7.6)	0.38 (9.7)
3SX03-KL551	3.00 (76.2)	0.75 (19.0)	0.32 (8.1)	0.42 (10.7)	0.20 (5.1)	0.24 (6.1)	3SX03-KL579	1.50 (38.1)	0.75 (19.0)	0.32 (8.1)	0.44 (11.2)	0.34 (8.6)	0.38 (9.7)
3SX03-KL552	2.00 (50.8)	0.688 (17.5)	0.25 (6.4)	0.42 (10.7)	0.12 (3.0)	0.18 (4.6)	3SX03-KL580	1.50 (38.1)	0.688 (17.5)	0.25 (6.4)	0.44 (11.2)	0.25 (6.4)	0.31 (7.9)
3SX03-KL553	2.50 (63.5)	0.688 (17.5)	0.25 (6.4)	0.42 (10.7)	0.12 (3.0)	0.18 (4.6)							

All dimensions shown in inches and (millimeters). For reference purpose only. Not to be used for design or construction purposes.

① Can accommodate both U.S. 1.16 (29.4) x 2.34 (59.5) and DIN 1.18 (30.0) x 2.36 (60.0) mounting dimensions.

# Limit Switches

## 3SE03 North American Limit Switches

Modular, plug-in and  
NEMA type 6P submersible

### Dimension drawings

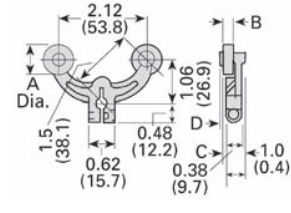
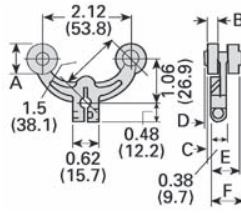
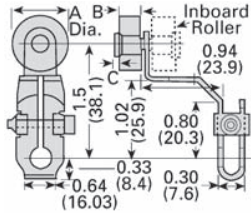

#### Offset roller levers

Catalog Number	Dimensions		
	A	B	C
<b>Outboard roller</b>			
3SX03-KL27	0.75 (19)	0.32 (8)	0.03 (1)
3SX03-KL28	0.75 (19)	0.32 (8)	0.03 (1)
3SX03-KL29	0.69 (18)	0.25 (6)	0.04 (1)
3SX03-KL30	0.75 (19)	1.0 (25)	-
<b>Inboard roller</b>			
3SX03-KL24	0.75 (19)	0.32 (8)	0.03 (1)
3SX03-KL25	0.75 (19)	0.32 (8)	0.03 (1)
3SX03-KL26	0.69 (18)	0.25 (6)	0.04 (1)

#### Fork lever, one roller inside, one roller outside

Catalog Number	Dimensions					
	A	B	C	D	E	F
3SX03-KL203	0.75 (19)	0.32 (8)	0.16 (4)	0.20 (5)	0.73 (19)	0.77 (20)
3SX03-KL541	0.75 (19)	0.32 (8)	0.16 (4)	0.20 (5)	0.73 (19)	0.77 (20)
3SX03-KL542	0.69 (18)	0.25 (6)	0.08 (2)	0.14 (4)	0.64 (16)	0.70 (18)

#### Fork lever - Both rollers on one side

Catalog Number	Dimensions			
	A	B	C	D
3SX03-KL204	0.75 (19)	0.32 (8)	0.16 (4)	0.20 (5)
3SX03-KL543	0.75 (19)	1.0 (25)	0.86 (22)	0.86 (22)
3SX03-KL544	0.75 (19)	0.32 (8)	0.16 (4)	0.20 (5)
3SX03-KL545	0.69 (18)	0.25 (6)	0.08 (2)	0.1 (3)

#### Bantam roller lever

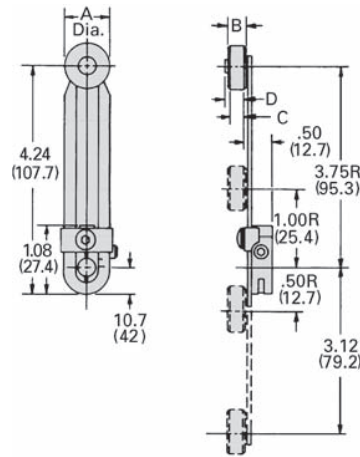
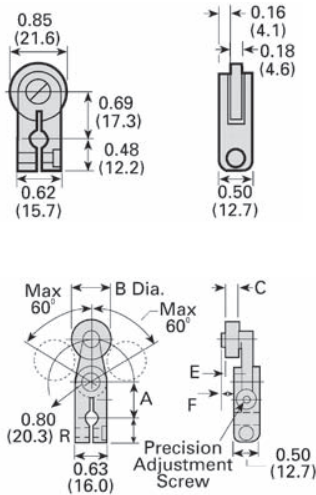

#### Precision adjustment roller lever

Catalog Number	Dimensions					
	A	B	C	D	E	F
3SX03-KL340	0.69 (18)	0.75 (19)	0.32 (8)	0.48 (12)	0.24 (6)	0.28 (7)
3SX03-KL465	0.69 (18)	0.75 (19)	0.32 (8)	0.48 (12)	0.24 (6)	0.28 (7)
3SX03-KL535	0.69 (18)	0.69 (18)	0.25 (6)	0.48 (12)	0.16 (4)	0.22 (6)

#### Adjustable roller lever

Catalog Number	Dimensions			
	A	B	C	D
3SX03-KL201	0.75 (19)	0.32 (8)	0.29 (7)	0.33 (8)
3SX03-KL443	1.5 (38)	0.29 (7)	0.26 (7)	0.32 (8)
3SX03-KL537	0.75 (19)	0.32 (8)	0.29 (7)	0.33 (8)
3SX03-KL538	0.69 (18)	0.25 (6)	0.21 (5)	0.27 (7)
3SX03-KL539	0.69 (18)	0.25 (6)	0.21 (5)	0.27 (7)
3SX03-KL598	0.39 (10)	0.11 (3)	0.11 (3)	0.19 (5)
3SX03-KL599	0.75 (19)	0.5 (13)	0.46 (12)	0.47 (12)

All dimensions shown in inches and (millimeters). For reference purposes only. Not to be used for design or construction purposes.



# Limit Switches

## 3SE03 North American Limit Switches

Modular, plug-in and  
NEMA type 6P submersible

1

2

3

4

5

6

7

8

9

10

11

12

13

### Dimension drawings

Nylon Spring Rod Actuator  
3SX03-KL556

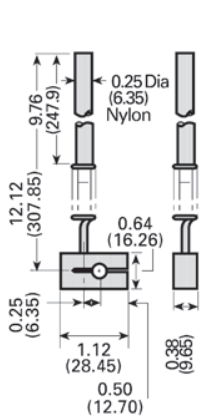

Nylon Covered Wire Actuator  
3SX03-KL533

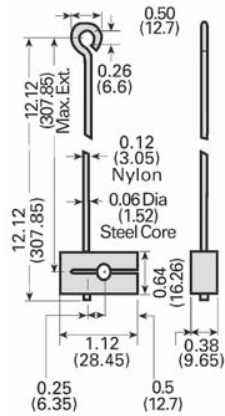

Stainless Steel Spring Actuator  
3SX03-KL421

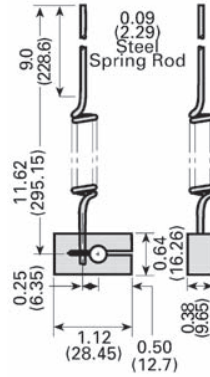

Adjustable Rod Actuator

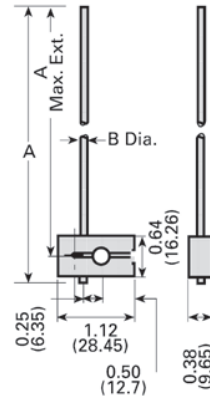

Adjustable Wire Roller Actuator  
3SX03-KL37

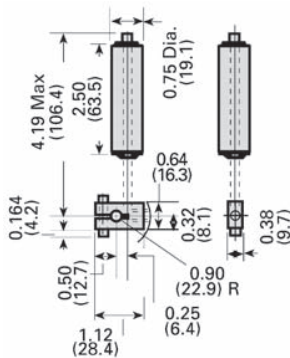

Nylatron Loop Actuator  
3SX03-KL142

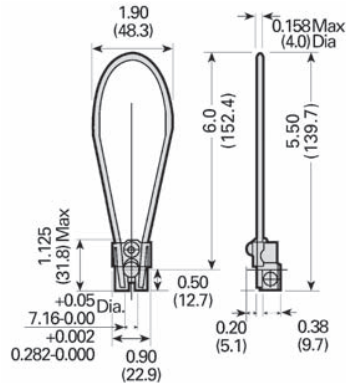

### Adjustable rod actuators

Catalog Number	Material	Dimensions	
		A	B
3SX03-KL202	Steel-Round	5.50 (140)	0.120 (3)
3SX03-KL581	Steel-Square	8.75 (222)	0.125 (3)
3SX03-KL399	Nylon	5.50 (140)	0.190 (5)
3SX03-KL220	Stainless Steel	9.00 (229)	0.190 (5)
3SX03-KL226	Plated Steel	12.0 (305)	0.120 (3)

Wobble head with nylon head  
3SE03-DW1  
3SX03-KW2

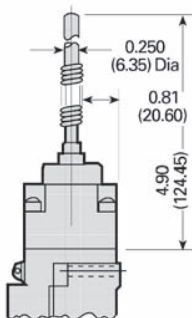

Wobble head with coil spring  
3SE03-DW1  
3SX03-KW4

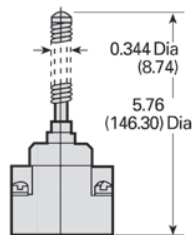

Wobble head with stainless steel rod  
3SE03-DW1  
3SX03-KW3

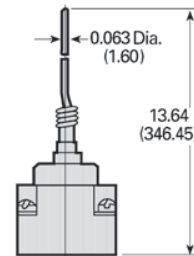

All dimensions shown in inches and (millimeters). For reference purposes only. Not to be used for design or construction purposes.

# Limit Switches

## 3SE03 North American Limit Switches

### 3SE03 Metal enclosure

#### Description

##### Features

- NEMA 1 Enclosed Aluminum Die Cast Housing
- Screw Terminals
- Booted versions for added protection

- 1/2" Conduit Entrance
- NEMA A600, R300 Contacts
- UL Recognized
- CSA Certified
- INO/INC Snap-action contacts (form c)

##### Application

These switches are designed for accurate repeatability. Their compact size makes them ideal for use in space-restricted areas.

Typical applications include overhead, folding and elevator doors, sliding gates and other automated equipment.

#### Overall dimensions

#### Specifications <sup>ⓐ</sup>

DT

Catalog Number

List Price \$ 1 unit

#### Plunger actuator

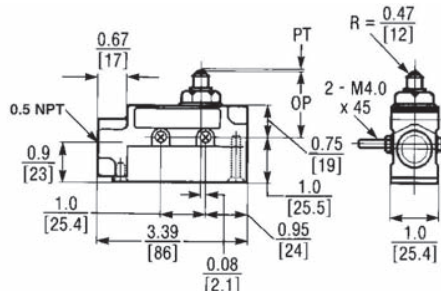

OF Max. - 8.82 - 12.3 oz.  
(250 - 350 g)  
RF Min. 4.02 oz. (114 g)  
PT Max. - 0.016 in. (0.4 mm)  
OT Min. - 0.217 in. (5.5 mm)  
MD Max. - 0.002 in. (0.05 mm)  
OP - 1.504 in. (38.2 mm)



3SE03 - EB05

#### Booted plunger

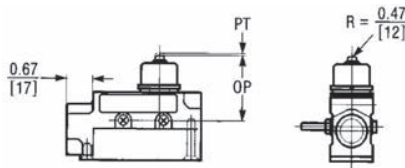

OF Max. - 28.22 oz. (800 g)  
RF Min. 8.46 oz. (240 g)  
PT Max. - 0.079 in. (2.0 mm)  
OT Min. - 0.197 in. (5.0 mm)  
MD Max. - 0.004 in. (0.1 mm)  
OP - 1.803 in. (45.8 mm)



3SE03 - EB06

#### Roller lever

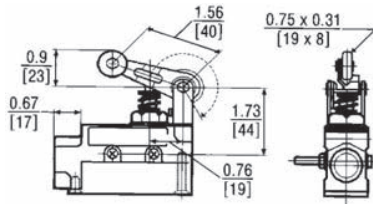

OF Max. - 20.1 oz. (570 g)  
RF Min. 6.0 oz. (170 g)  
PT Max. - 0.157 in. (4.0 mm)  
OT Min. - 0.236 in. (6.0 mm)  
MD Max. - 0.016 in. (0.4 mm)



3SE03 - EB32

#### Booted roller lever

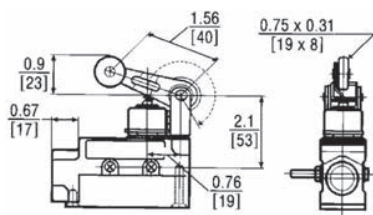

OF Max. - 22.57 oz. (640 g)  
RF Min. 8.11 oz. (230 g)  
PT Max. - 0.197 in. (5.0 mm)  
OT Min. - 0.236 in. (6.0 mm)  
MD Max. - 0.016 in. (0.4 mm)



3SE03 - EB33

<sup>ⓐ</sup> OF = Operating Force  
RF = Return Force  
PT = Pretravel  
OT = Operating Travel  
MD = Movement Differential  
OP = Operating Position

# Limit Switches

## 3SE03 North American Limit Switches

3SE03 Metal enclosure

1  
2  
3  
4  
5  
6  
7  
8  
9  
10  
11  
12  
13

### Dimension drawings

#### Overall dimensions

#### Roller plunger

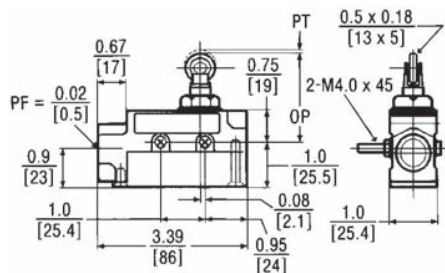

OF Max. - 9.92 - 12.3 oz.  
(250 - 350 g)  
RF Min. 4.02 oz. (114 g)  
PT Max. - 0.02 in. (0.5 mm)  
OT Min. - 0.142 in. (3.6 mm)  
MD Max. - 0.002 in. (0.05 mm)  
OP - 1.957 in. (49.7 mm)

▶ 3SE03 - EB07

#### Booted roller plunger

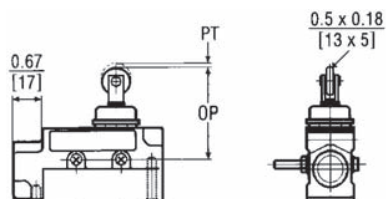

OF Max. - 17.64 oz. (500 g)  
RF Min. 3.53 oz. (100 g)  
PT Max. - 0.039 in. (1.0 mm)  
OT Min. - 0.138 in. (3.5 mm)  
MD Max. - 0.006 in. (0.12 mm)  
OP - 1.957 in. (49.7 mm)

▶ 3SE03 - EB08

#### Technical data

<b>Mechanical Life</b>	3,000,000 operations maximum							
<b>Electrical Life</b>	500,000 operations minimum							
<b>Operating Speed</b>	0.01 m/second to 1m/second							
<b>Cable Entry</b>	1/2" NPT							
<b>Temperature Range</b>	-15° to 80° (5° to 176°F)							
<b>Degree of Protection</b>	NEMA 1							
<b>Mounting</b>	Any Position							
<b>NEMA Rating</b>	A600, R300							
<b>Rated Voltage (V)<sup>1)2)</sup></b>	Non-Inductive Load (A)			Inductive load (A)			Inrush current (A)	
	Resistive load		Lamp load	Inductive load		Motor load	NO	NC
	NC-NO	NO	NC	NC-NO	NO	NC		
<b>125 VAC</b>	15	3	1.5	15	5	2.5	30 maximum	15 maximum
<b>250 VAC</b>	15	2.5	1.25	15	3	1.5		
<b>500 VAC</b>	3	1.5	0.75	2.5	1.5	0.75		
<b>8 VDC</b>	15	3	1.5	15	5	2.5		
<b>14 VDC</b>	15	3	1.5	10	5	2.5		
<b>30 VDC</b>	6 (2)	3	1.5	5	5	2.5		
<b>125 VDC</b>	0.4	0.4	0.4	0.05	0.05	0.05		
<b>250 VDC</b>	0.2	0.2	0.2	0.03	0.03	0.03		

1) Inductive load has power factor of 0.04 minimum (AC) and a time of 7m/second (DC)

2) Lamp load has an inrush current of 6 times steady-state current.

# Mechanical Safety

## 3SE7 Cable-Operated Switches

### General Information

#### Application

Cable-operated switches are used for monitoring or for EMERGENCY-STOP facilities on particularly endangered system sections. They are available with metal enclosures.

As the effective range of a cable-operated switch is limited by the length of the pull-wire, large systems can also be protected.

Cable-operated switches (requiring pulling at both ends) and conveyor belt unbalance trackers are used primarily for monitoring very long belt systems.

#### Specifications

Switches with latching for implementation in EMERGENCY-STOP equipment correspond to the EN 418 standard.

#### Principle of operation

The switch contacts of the cable-operated switches and the conveyor belt unbalance protection devices are positive opening.

Cable-operated switches with one-side operation are held in free position by the pre-tension force on the turnbuckle.

- In the 3SE7 140, -150 and -160 cable-operated switches, both switching contacts are available for cable-break/cable pull signaling. The NO contact is used, for example, for signaling purposes.

For switches with latching, with a pretensioned cable, the locking must be deactivated beforehand in order to return the switch to its free position.

#### Technical data

Type	3SE7 120	3SE7 150	3SE7 140	3SE7 141	3SE7 160	3SE7 310
<b>Standards</b>	IEC 60947-5-1, EN 60947-5-1; IEC 60204-1, EN 60204-1; EN ISO 13850					
<b>Certifications</b>	UL / CSA					
<b>Electrical design</b>	Contacts electrically isolated from each other					
<b>Electrical loading</b>	<ul style="list-style-type: none"> <li>at AC-15</li> <li>minimum</li> </ul>					
	AC 400 V, 6A			AC 250 V, 2A	AC 400 V, 6A	
	AC/DC 24 V, 10 mA					
<b>Short circuit protection</b>	6 A (Slow acting)					
<b>Mechanical endurance</b>	> 1 x 10 <sup>6</sup> operating cycles					
<b>Contact material</b>	Fine silver					
<b>Actuation</b>	By pulling or breaking of a rope (cable)					
<b>Rope length, maximum Spacing between rope supports, maximum</b>	10 m 2.5 m	25 m 3 m	50 m 5 m	75 m <sup>1)</sup> 5 m	2 x 50 m 5 m	– –
<b>Enclosure</b>	GDAL alloy, coated (color), dark black RAL 9005					
<b>Cover</b>	Shock-resistant thermoplastic					
<b>Degree of protection acc. To IEC 60529</b>	IP65			IP67	1P65	
<b>Ambient temperature</b>	-25C to +70C					
<b>Mounting</b>	Designed for M 5					
<b>Mounting space</b>	30 mm and 40 mm					
<b>Cable entry</b>	2x(M20x1.5)	2x(M20x1.5)	1x(M16x1.5)	3x(M20x1.5)	2x(M25x1.5)	
<b>Type of connection</b>	M3.5 screw connection; Self-lifting pressure plate terminals					

#### Travel diagrams

3SE7 120-2DD01

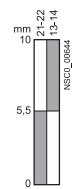

NSC0\_0067 45

Central position

3SE7 140-1.F00

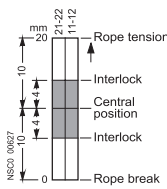

NSC0\_00629

Central position

3SE7 141-1EG10

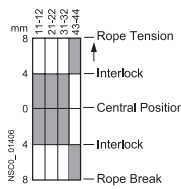

NSC0\_01406

Central position

3SE7 140-1.D0.

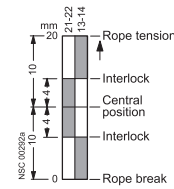

NSC000293

Central position

3SE7 120-1BF00, 3SE7 150-1BF00

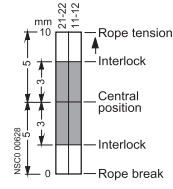

NSC 00629

Central position

3SE7 160-1AE, 3SE7 310-1AE

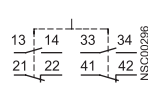
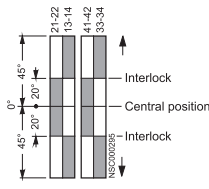

NSC000286

Central position

3SE7 150-1.D00, 3SE7 150-2DD00

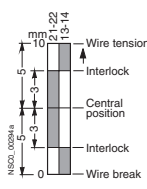

NSC000293

Central position

1) 75 m cable length possible provided the ambient temperature range is strictly observed, otherwise, 50 m.

# Mechanical Safety

## SIRIUS 3SE7 Cable-Operated Switches

Selection

1  
2  
3  
4  
5  
6  
7  
8  
9  
10  
11  
12  
13

### Selection and ordering data

Version	Wire length	Contacts	DT	Order No.	Price per PU	PU (UNIT, SET, M)	PS*	
<b>Cable-operated switches</b>								
 <p>3SE7 120-1BH00</p>	10	<b>Metal enclosures, IP65</b> (cover made of molded plastic)						
		• Without latching, only cable pull monitoring	1 NO + 1 NC	↻	A	<b>3SE7 120-2DD01</b>	1	1 unit
		• With latching and button reset	2 NC	↻	A	<b>3SE7 120-1BF00</b>	1	1 unit
		- With yellow lid	1 NO + 2 NC	↻	A	<b>3SE7 120-1BH00</b>	1	1 unit
 <p>3SE7 150-1BD00 3SE7 150-1BH00</p>	25	<b>Metal enclosures, IP65</b> (cover made of molded plastic), with alignment window						
		• Without latching	1 NO + 1 NC	↻	A	<b>3SE7 150-2DD00</b>	1	1 unit
		• With latching and button reset	1 NO + 1 NC	↻	▶	<b>3SE7 150-1BD00</b>	1	1 unit
			2 NC	↻	▶	<b>3SE7 150-1BF00</b>	1	1 unit
		- With yellow lid	1 NO + 2 NC	↻	▶	<b>3SE7 150-1BH00</b>	1	1 unit
• With latching and key unlatching	1 NO + 1 NC	↻	B	<b>3SE7 150-1CD00</b>	1	1 unit		
 <p>3SE7 150-1BD04</p>	25	<b>Metal enclosures, IP65</b> (cover made of molded plastic), with alignment window, with LED, red, 24 V DC						
		• Without latching	1 NO + 1 NC	↻	B	<b>3SE7 150-2DD04</b>	1	1 unit
		• With latching and button reset	1 NO + 1 NC	↻	▶	<b>3SE7 150-1BD04</b>	1	1 unit
 <p>3SE7 140-1B00</p>	50	<b>Metal enclosures, IP65</b> (cover made of molded plastic)						
		• With latching and button reset	1 NO + 1 NC	↻	A	<b>3SE7 140-1BD00</b>	1	1 unit
			2 NC	↻	▶	<b>3SE7 140-1BF00</b>	1	1 unit
		• In addition with LED, red, 24 V DC	1 NO + 1 NC	↻	B	<b>3SE7 140-1BD04</b>	1	1 unit
		• With latching and key unlatching	1 NO + 1 NC	↻	B	<b>3SE7 140-1CD00</b>	1	1 unit
 <p>3SE7 141-1EG10</p>	75	<b>Metal enclosures, IP67</b> (cover made of molded plastic), with EMERGENCY-STOP mushroom, with rotate-to-unlatch mechanism						
			1 NO + 3 NC	↻	▶	<b>3SE7 141-1EG10</b>	1	1 unit
 <p>3SE7 160-1AE00</p>	2 × 75	<b>Metal enclosures, IP65</b> with actuation on both sides						
		• With latching and button reset	2 NO + 2 NC	↻	A	<b>3SE7 160-1AE00</b>	1	1 unit
			1 NO + 1 NC	↻	B	<b>3SE7 160-1BD00</b>	1	1 unit
		• In addition with LED, red, 24 V DC	2 NO + 2 NC	↻	B	<b>3SE7 160-1AE04</b>	1	1 unit

↻ Positive opening according to IEC 60947-5-1, Appendix K.

# Mechanical Safety

## SIRIUS 3SE7 Cable-Operated Switches

### Selection

Version	Contacts	DT	Order No.	Price per PU	PU (UNIT, SET, M)	PS*
---------	----------	----	-----------	--------------	-------------------	-----

#### Conveyor belt unbalance trackers



3SE7 310-1AE00

#### Metal enclosures, IP65

- With latching and button reset
- In addition with LED, red, 24 V DC

2 NO + 2 NC	↻	B	<b>3SE7 310-1AE00</b>		1	1 unit
2 NO + 2 NC	↻	B	<b>3SE7 310-1AE04</b>		1	1 unit

↻ Positive opening according to IEC 60947-5-1, Appendix K.

Product Category: SFTY

### Accessories

#### Configuration of the cable-operated switches

##### Short lengths of wire up to 25 m

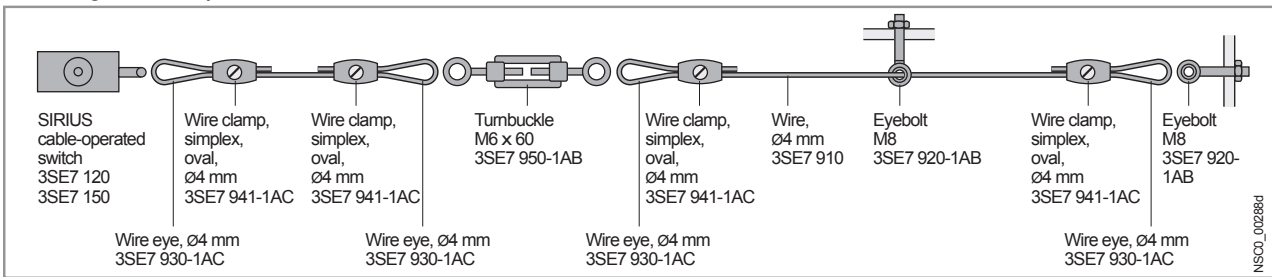

##### Long lengths of wire up to 50 m

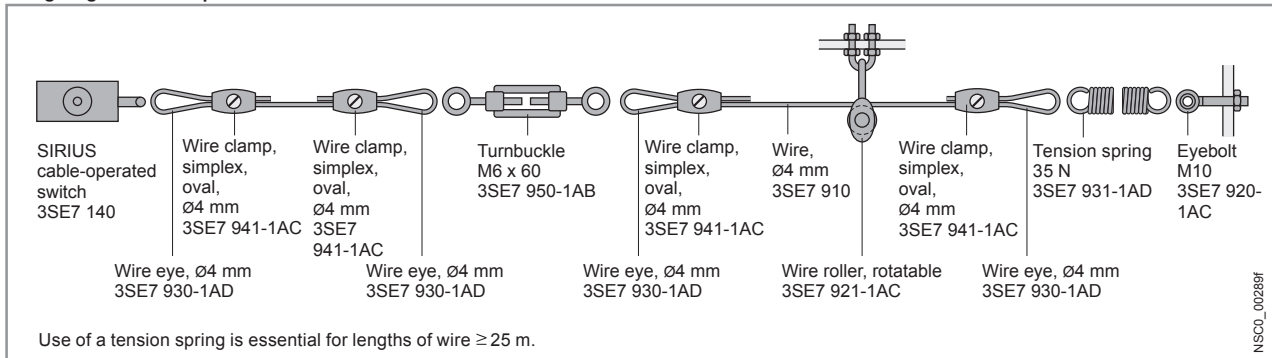

##### Pulling from both sides up to 2 x 75 m

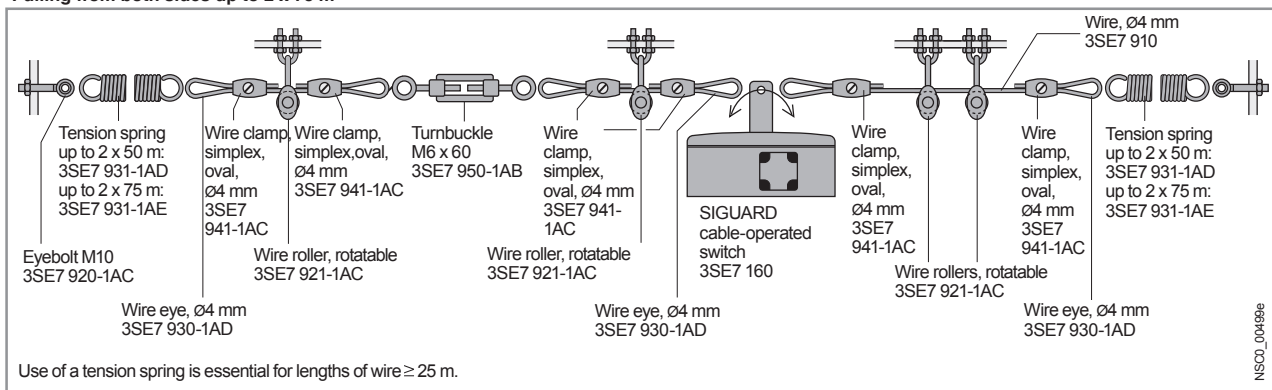

#### Note:

Large temperature fluctuations require corresponding compensation springs. For reliable connection the PVC sheath must be

removed from the clamping area of the steel trip-wire. Wire supports must be used at the recommended intervals.

# Mechanical Safety

## SIRIUS 3SE7 Cable-Operated Switches

### Accessories

1

2

3

4

5

6

7

8









9

10

11

12

13

Version	Wire length/ diameter	DT	Order No.	Price per PU	PU (UNIT, SET, M)	PS*
<b>Trip-wire with fixing</b>						
	<b>Steel wires</b> , with red plastic sheath, Ø 4 mm <sup>1)</sup>	10 m	A	<b>3SE7 910-3AA</b>	1	1 unit
		15 m	A	<b>3SE7 910-3AB</b>	1	1 unit
		20 m	▶	<b>3SE7 910-3AC</b>	1	1 unit
		50 m	A	<b>3SE7 910-3AH</b>	1	1 unit
	<b>Wire clamps</b> , galvanized white					
	• Oval	2 × Ø 4 mm	A	<b>3SE7 941-1AC</b>	1	1 unit
	• Simplex (1 set = 4 units)	2 × Ø 4 mm	▶	<b>3SE7 943-1AC</b>	1	4 units
	• Duplex (1 set = 4 units)	2 × Ø 4 mm	A	<b>3SE7 944-1AC</b>	1	4 units
	• Single (1 set = 4 units)	2 × Ø 4 mm	A	<b>3SE7 942-1AA</b>	1	4 units
	<b>Tension springs</b> (zinc-plated) to maintain the counter tension					
	• 13 N		A	<b>3SE7 931-1AB</b>	1	1 unit
	• 35 N, for trip-wires up to 50 m		▶	<b>3SE7 931-1AD</b>	1	1 unit
	• > 35 N, for trip-wires up to 2 × 75 m		▶	<b>3SE7 931-1AE</b>	1	1 unit
	<b>Wire rollers</b> for changing the direction of the wire, Ø 4 mm rotatable		A	<b>3SE7 921-1AC</b>	1	1 unit
	<b>Fixtures for the wire rollers</b> (incl. fixing nuts)		▶	<b>3SE7 921-1AA</b>	1	1 unit
	<b>Wire eyes</b> for changes in wire direction and improved power transmission at the fixing points (1 set = 4 units)	Ø 4 mm	▶	<b>3SE7 930-1AD</b>	1	4 units
	<b>Eyebolts</b> for fixing the wire					
	• Including M8 nut		A	<b>3SE7 920-1AB</b>	1	1 unit
	• Including M10 nut		▶	<b>3SE7 920-1AC</b>	1	1 unit
	<b>Turnbuckles</b> for precise adjustment of the pretension					
	• M6 × 60		A	<b>3SE7 950-1AB</b>	1	1 unit
	• M6 × 110		A	<b>3SE7 950-1AD</b>	1	1 unit
	<b>Spare parts</b>					
	<b>LED lamps</b> , red 24 V DC 25 mm diameter; for M20 × 1.5 connection		D	<b>3SX3 235</b>	1	1 unit

<sup>1)</sup> Diameter including casing; the diameter of the steel wire is 3.2 mm.

# 3SE Mechanical Safety

## Cable-Operated Switches

### 3SE7, metal enclosures

#### Dimension drawings

##### Metal enclosure

**3SE7 120-2DD.., 3SE7 150-2DD..**  
without latching

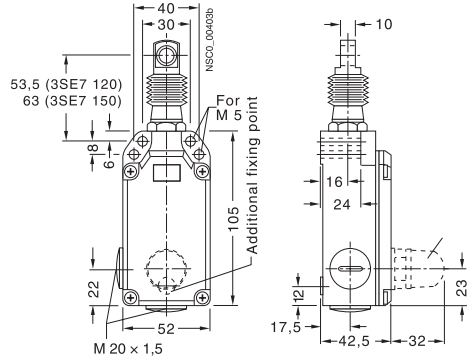

**3SE7 120-1B..., 3SE7 150-1B...**  
with latching and button reset

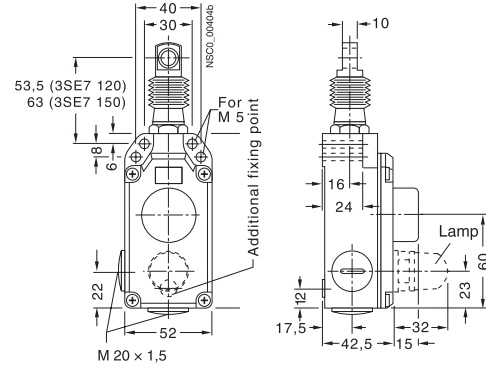

##### Metal enclosure

**3SE7 140-1B...**  
with latching and button reset

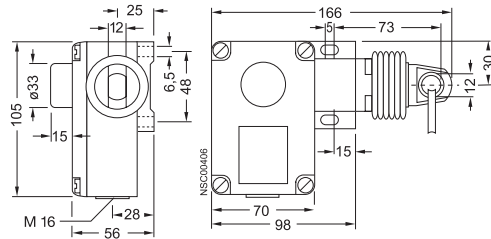

**3SE7 140-1ECD.**  
with latching and key reset

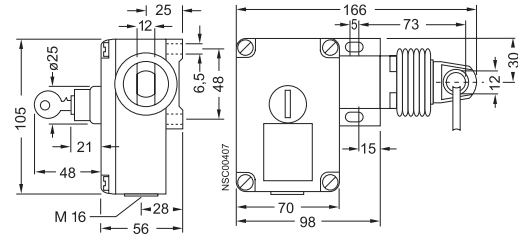

##### Metal enclosure

**3SE7 150-1CD..**  
with latching and key reset

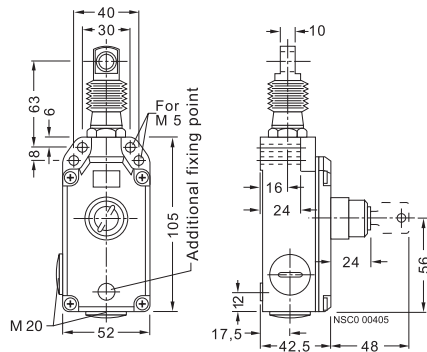

**3SE7 141-1EG10.**  
with EMERGENCY STOP and Lockout release

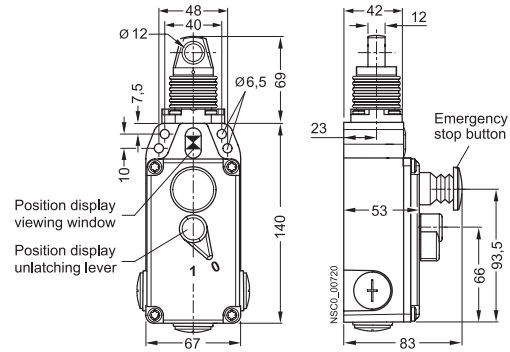

**3SE7 160-1AE..**  
with latching and button reset

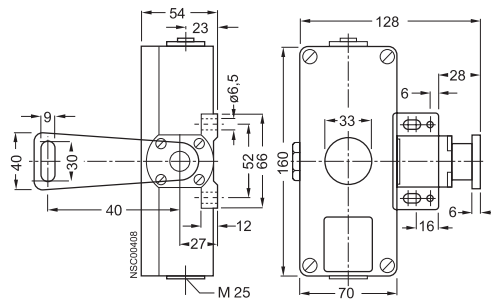

**3SE7 310-1AE.. conveyor belt unbalance protection device**  
with latching and button reset

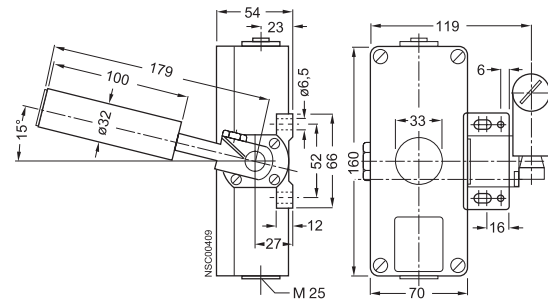



### Overview

Position switches with separate actuator are used where the position of doors, covers or protective grills must be monitored for safety reasons.

3SE5 position switches with separate actuator have the same enclosures as the standard switches (modular system).



Position switches with head for separate actuator

### Design

#### Enclosure sizes

The 3SE5 switches are available in various enclosure sizes:

- Plastic enclosures according to EN 50047, 31 mm wide, IP65, 1 cable entry
- Metal enclosures according to EN 50047, 31 mm wide, IP66/IP67, 1 cable entry
- Plastic and metal enclosures according to EN 50041, 40 mm wide, IP66/IP67, 1 cable entry
- Plastic enclosures, 50 mm wide, IP66/IP67, 2 cable entries
- Metal enclosures, 56 mm wide, IP66/IP67, 3 cable entries

Also available is a switch in the 3SE2 series which has arisen in this form according to general market requirements:

- Molded-plastic enclosures outside of the standards, enclosure width 52 mm, IP67

#### Enclosure versions

Various basic versions can be selected for the enclosures of the 3SE5 series:

- Available with two- or three-pole contact blocks designed as slow-action contacts
- Optional LED status display
- With mounted four- or five-pole M12 connector socket (available for the wide enclosures as an accessory for self-assembly)
- With 6-pole connector socket + PE on the metal enclosures
- Similarly with a combination of connector socket and LED indicators
- Metal enclosures for explosion protection (ATEX) ([see online](#))
- AS-Interface version with integrated ASIsafe electronics for all enclosure designs ([see online](#))

For a description of the basic switches, [see page 13/6](#).

### Operation

The actuator head is included in the scope of supply. For actuation from four directions it can be adjusted through  $4 \times 90^\circ$ . The switches can also be approached from above.

The twist actuators of the 3SE2 243 and 3SE2 257 switches with special enclosures cannot be changed. The switches can be approached from the two broad sides and from above.

The actuators are not included in the scope of supply of the position switch and must be ordered separately from various versions to suit the application ([see page 13/86](#)).

The actuator is encoded. Simple overruling by hand or auxiliary devices is impossible.

#### Radius actuators

The position switches with radius actuators are particularly suitable for rotatable protective devices. The movable actuation key allows even small radii to be approached. Damage to the switch and the actuator due to inaccurate approach is prevented.

#### Locking devices

A high-grade steel blocking insert for attaching up to eight padlocks is available for even more safety ([see page 13/86](#)).



Blocking insert with padlock

#### Dust protection

A rubber cap to protect the twist actuator from contamination is available for operation in dusty environments ([see page 13/86](#)).

#### Contact reliability

The new contact blocks ensure an extremely high contact stability. This applies even when the devices are switching low voltages and currents, e.g. 1 mA at 5 V DC.

#### Positive opening

The NC contacts of the switch are forced open mechanically, positively-driven and reliably by the plunger. This is referred to as "positive opening".

# Limit Switches





## SIRIUS 3SE5 Interlock Switches

3SE5, plastic enclosures  
with separate actuator

### Selection and ordering data

#### Complete units

2 or 3 contacts · 5 directions of approach · Degree of protection IP65 or IP66/IP67 · Cable entry M20 × 1.5

Version <sup>1)</sup>	Contacts	LEDs	DT	Complete units	<input type="checkbox"/>	PU (UNIT, SET, M)	PS*	PG	Weight per PU approx.
				Order No.	List Price \$ per PU				kg
<b>Enclosure width 31 mm to EN 50047</b>									
	<b>5 directions of approach</b>								
	Slow-action contacts	1 NO + 1 NC --	⊕ ▶	<b>3SE5 232-0RV40</b>		1	1 unit	102	0.150
	Slow-action contacts	1 NO + 2 NC --	⊕ ▶	<b>3SE5 232-0QV40</b>		1	1 unit	102	0.155
	<b>With increased minimum pull-out force 30 N</b>								
	Slow-action contacts	1 NO + 1 NC --	⊕ B	<b>3SE5 232-0QV40-1AA1</b>		1	1 unit	102	0.150
	<b>With M12 connector socket, 4-pole (250 V, 4 A)</b>								
	Slow-action contacts	1 NO + 1 NC --	⊕ B	<b>3SE5 234-0RV40-1AC4</b>		1	1 unit	102	0.165
	Slow-action contacts	1 NO + 2 NC --	⊕ B	<b>3SE5 234-0QV40-1AE0</b>		1	1 unit	102	0.170
	<b>With 2 LEDs, yellow/green</b>								
	Slow-action contacts	1 NO + 1 NC 24 V DC	⊕ B	<b>3SE5 232-1RV40</b>		1	1 unit	102	0.155
	Slow-action contacts	1 NO + 1 NC 230 V AC	⊕ B	<b>3SE5 232-3RV40</b>		1	1 unit	102	0.110
	<b>With M12 connector socket, 5-pole (125 V, 4 A) and 2 LEDs</b>								
	Slow-action contacts	1 NO + 1 NC 24 V DC	⊕ C	<b>3SE5 234-1RV40-1AF3</b>		1	1 unit	102	0.175
<b>Enclosure width 50 mm</b>									
	<b>5 directions of approach</b>								
	Slow-action contacts	1 NO + 2 NC --	⊕ B	<b>3SE5 242-0QV40</b>		1	1 unit	102	0.110
	<b>With increased minimum pull-out force 30 N</b>								
	Slow-action contacts	1 NO + 1 NC --	⊕ B	<b>3SE5 242-0RV40-1AA1</b>		1	1 unit	102	0.110
	<b>With 2 LEDs, yellow/green</b>								
	Slow-action contacts	1 NO + 2 NC 24 V DC	⊕ B	<b>3SE5 242-1QV40</b>		1	1 unit	102	0.120
	Slow-action contacts	1 NO + 2 NC 230 V AC	⊕ C	<b>3SE5 242-3QV40</b>		1	1 unit	102	0.120

⊕ Positive opening according to IEC 60947-5-1, Appendix K.

1) Supplied without actuator. Please order separately (see page 13/86).

For 1/2" NPT adaptors and cable glands, see page 13/48.

# Mechanical Safety

## SIRIUS 3SE5 Interlock Switches



3SE5, plastic enclosures  
Enclosure width 40 mm acc. to EN 50041

1  
2  
3  
4  
5  
6  
7  
8  
9  
10  
11  
12  
13

### Selection and ordering data

#### Complete units

2 or 3 contacts · 5 directions of approach · Degree of protection IP66/IP67 · Cable entry M20 × 1.5

Version <sup>1)</sup>	Contacts	LEDs	DT	Complete units	PU (UNIT, SET, M)	PS*
						
						
				Order No.	Price per PU	

#### Enclosure width 40 mm acc. to EN 50041



With separate actuator

5 directions of approach								
Slow-action contacts	1 NO + 2 NC	—	↻ B	<b>3SE5 132-0QV20</b>	1	1 unit		
With 2 LEDs, yellow/green								
Slow-action contacts	1 NO + 2 NC	24 V DC	↻ C	<b>3SE5 132-1QV20</b>	1	1 unit		
Slow-action contacts	1 NO + 2 NC	230 V AC	↻ C	<b>3SE5 132-3QV20</b>	1	1 unit		



With 2 LEDs

 For online configurator see [www.siemens.com/sirius/configurators](http://www.siemens.com/sirius/configurators).

 Positive opening according to IEC 60947-5-1, Appendix K.

1) Supplied without actuator. Please order separately (see page 13/86).

# Limit Switches

## SIRIUS 3SE5 Interlock Switches

3SE5, metal enclosures  
Enclosure width 31 mm acc. to EN 50047

### Selection and ordering data

#### Complete units

2 or 3 contacts · 5 directions of approach · Degree of protection IP66/IP67 · Cable entry M20 × 1.5

Version <sup>1)</sup>	Contacts	LEDs	DT	Complete units	PU (UNIT, SET, M)	PS*
						
				Order No.	Price per PU	

#### Enclosure width 31 mm acc. to EN 50047



With separate actuator

##### 5 directions of approach

Slow-action contacts	1 NO + 1 NC	—	↻ A	<b>3SE5 212-0RV40</b>	1	1 unit
Slow-action contacts	1 NO + 2 NC	—	↻ B	<b>3SE5 212-0QV40</b>	1	1 unit



With 2 LEDs

##### With 2 LEDs, yellow/green

Slow-action contacts	1 NO + 1 NC	24 V DC	↻ B	<b>3SE5 212-1RV40</b>	1	1 unit
Slow-action contacts	1 NO + 1 NC	230 V AC	↻ B	<b>3SE5 212-3RV40</b>	1	1 unit

 For online configurator see [www.siemens.com/sirius/configurators](http://www.siemens.com/sirius/configurators).

 Positive opening according to IEC 60947-5-1, Appendix K.

1) Supplied without actuator. Please order separately (see page 13/86).

# Mechanical Safety

## SIRIUS 3SE5 Interlock Switches

3SE5, metal enclosures  
with separate actuator

1  
2  
3  
4  
5  
6  
7  
8  
9  
10  
11  
12  
13





### Selection and ordering data

#### Complete units



2 or 3 contacts · 5 directions of approach · Degree of protection IP66/IP67 · Cable entry M20 × 1.5

Version <sup>1)</sup>	Contacts	LEDs	DT	Complete units	PU (UNIT, SET, M)	PS*	PG	Weight per PU approx.
				Order No.	List Price \$ per PU			kg

#### Enclosure width 40 mm to EN 50041

	<b>5 directions of approach</b>							
	Slow-action contacts	1 NO + 2 NC --	⊕ ▶	<b>3SE5 112-0QV10</b>	1	1 unit	102	0.360
	<b>With increased minimum pull-out force 30 N</b>							
	Slow-action contacts	1 NO + 2 NC --	⊕ B	<b>3SE5 112-0QV10-1AA7</b>	1	1 unit	102	0.360
	<b>With M12 connector socket, 5-pole (125 V, 4 A)</b>							
	Slow-action contacts	1 NO + 1 NC --	⊕ C	<b>3SE5 114-0RV10-1AC5</b>	1	1 unit	102	0.360
	Slow-action contacts	2 NC --	⊕ C	<b>3SE5 114-0QV10-1AE1</b>	1	1 unit	102	0.360
	<b>With connector socket, 6-pole + PE (250 V, 10 A)</b>							
	Slow-action contacts	1 NO + 2 NC --	⊕ C	<b>3SE5 115-0QV10-1AD1</b>	1	1 unit	102	0.380
	<b>With 2 LEDs, yellow/green</b>							
	Slow-action contacts	1 NO + 2 NC 24 V DC	⊕ B	<b>3SE5 112-1QV10</b>	1	1 unit	102	0.370
	Slow-action contacts	1 NO + 2 NC 230 V AC	⊕ C	<b>3SE5 112-3QV10</b>	1	1 unit	102	0.370
	<b>With M12 connector socket, 5-pole (125 V, 4 A) and 2 LEDs</b>							
	Slow-action contacts	1 NO + 1 NC 24 V DC	⊕ C	<b>3SE5 114-1RV10-1AF3</b>	1	1 unit	102	0.360
	<b>With connector socket, 6-pole + PE (10 A) and 2 LEDs</b>							
	Slow-action contacts	1 NO + 1 NC 24 V DC	⊕ C	<b>3SE5 115-1RV10-1AF2</b>	1	1 unit	102	0.380

#### Enclosure width 56 mm

	<b>5 directions of approach</b>							
	Slow-action contacts	1 NO + 2 NC --	⊕ ▶	<b>3SE5 122-0QV10</b>	1	1 unit	102	0.360
	<b>With increased minimum pull-out force 30 N</b>							
	Slow-action contacts	1 NO + 2 NC --	⊕ B	<b>3SE5 122-0QV10-1AA7</b>	1	1 unit	102	0.360
	<b>With 2 LEDs, yellow/green</b>							
	Slow-action contacts	1 NO + 2 NC 24 V DC	⊕ ▶	<b>3SE5 122-1QV10</b>	1	1 unit	102	0.370
	Slow-action contacts	1 NO + 2 NC 230 V AC	⊕ C	<b>3SE5 122-3QV10</b>	1	1 unit	102	0.370

⊕ Positive opening according to IEC 60947-5-1, Appendix K.

1) Supplied without actuator. Please order separately (see page 13/86).

For 1/2" NPT adaptors and cable glands, see page 13/48.

# Limit Switches

## SIRIUS 3SE5 Interlock Switches

### 3SE5, metal and plastic enclosures Accessories

#### Selection and ordering data

Version	DT	Order No.	List Price \$ per PU	PU (UNIT, SET, M)	PS*	PG	Weight per PU approx. kg
<b>Actuators for 3SE5</b>							
 3SE5 000-0AV01	Standard actuators, length 75.6 mm	A	<b>3SE5 000-0AV01</b>		1	1 unit	102 0.040
 3SE5 000-0AV02	With vertical fixing, length 53 mm	▶	<b>3SE5 000-0AV02</b>		1	1 unit	102 0.070
 3SE5 000-0AV03	With transverse fixing, length 47 mm	▶	<b>3SE5 000-0AV03</b>		1	1 unit	102 0.070
 3SE5 000-0AV06	Radius actuators, length 51 mm • Direction of approach from the left • Direction of approach from the right	▶ A	<b>3SE5 000-0AV04</b> <b>3SE5 000-0AV06</b>		1 1	1 unit 1 unit	102 0.070 102 0.070
 3SE5 000-0AV05	Universal radius actuators, length 77 mm	▶	<b>3SE5 000-0AV05</b>		1	1 unit	102 0.090
 3SE5 000-0AV07	Universal radius actuators, heavy-duty • Length 67 mm • Length 77 mm	A A	<b>3SE5 000-0AV07-1AK2</b> <b>3SE5 000-0AV07</b>		1 1	1 unit 1 unit	102 0.120 102 0.090
<b>Optional accessories for 3SE5</b>							
 3SE5 000-0AV08-1AA2	<b>Protective caps</b> made of black rubber for the actuator head, to protect the actuator openings from contamination Not to be used for 3SE5 2.. plastic enclosures.	B	<b>3SE5 000-0AV08-1AA2</b>		1	1 unit	102 0.010
 3SE5 000-0AV08-1AA3	<b>Blocking inserts</b> , high-grade steel, for actuator head, for up to 8 padlocks	B	<b>3SE5 000-0AV08-1AA3</b>		1	1 unit	102 0.065
<b>Connections for 3SE5, 3SE2</b>							
 3SY3 127	<b>Connector sockets (4-pole), M12, fixed for M20 x 1.5</b> For max. 250 V, 4 A With 0.25 mm <sup>2</sup> connecting cable, plastic, degree of protection IP67, ambient temperature -40 to +85 °C	B	<b>3SY3 127</b>		1	1 unit	102 0.010
 3RX8 000	<b>Cable boxes (4-pole), M12</b> With terminal compartment, can be pre-assembled	A	<b>3RX8 000-0CB45</b>		1	1 unit	574 0.015
	<b>Angular cable boxes (4-pole), M12</b> With terminal compartment, can be pre-assembled	A	<b>3RX8 000-0CC45</b>		1	1 unit	574 0.015
 3SX9 926	<b>Connector sockets (5-pole), M12, fixed for M20 x 1.5</b> For max. 125 V, 4 A With 0.25 mm <sup>2</sup> connecting cable, plastic, degree of protection IP67, ambient temperature -40 to +85 °C	B	<b>3SY3 128</b>		1	1 unit	102 0.010
	<b>Cable boxes (5-pole), M12</b> With terminal compart., can be pre-assembled	A	<b>3RX8 000-0CB55</b>		1	1 unit	574 0.016
	<b>Angular cable boxes (5-pole), M12</b> With terminal compart., can be pre-assembled	A	<b>3RX8 000-0CC55</b>		1	1 unit	574 0.016
	<b>Cable glands M20 x 1.5</b> Plastic	A	<b>3SX9 926</b>		1	1 unit	102 0.010

#### Selection and ordering data

1 contact · 3 contacts · Moving double-break contacts<sup>1) 2)</sup>

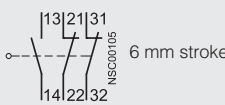
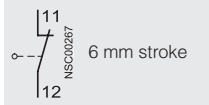
Actuation	Enclosure width	Length of actuator	DT	3SE. position switches with 3 slow-action contacts	3SE. position switches with 1 slow-action contact	Wght. approx.
				 <p>Ident. No. <b>12</b> acc. to EN 50 013</p>	 <p>Ident. No. <b>01</b> acc. to EN 50 013</p>	
	mm	mm		Order No.	List Price \$ 1 unit	kg
				Order No.	List Price \$ 1 unit	kg

#### Molded plastic enclosure IP 67

3SE2 243-0XX

**Top and side entry<sup>1)</sup>**



M20 x 1.5 connecting thread

- Extraction force 5 N 52
- Extraction force 30 N 52
- With automatic ejection 52

M16 x 1.5 connecting thread

- Extraction force 5 N 52
- Extraction force 30 N 52
- With automatic ejection 52

#### Actuators



- Standard actuator ( $r_{min.} = 150$  mm) 28



- Radius actuator (universal) ( $r_{min.} = 45$  mm) 33



- Ball catch (up to 100 N) 28



- Actuator with dust protector and slit cover (1 set) 34

- Radius actuator 82

#### Accessories

- Slit cover only for 3SX3234 (1 set = 3 units)

→ 3SE2 243-0XX40	0.140	→ 3SE2 257-6XX40	0.120
→ 3SE2 243-0XX	0.140	→ 3SE2 257-6XX	0.120
→ 3SE2 243-0XX30	0.140	→ 3SE2 257-6XX30	0.120
→ 3SE2 243-0XX48	0.140	→ 3SE2 257-6XX48	0.140
→ 3SE2 243-0XX18	0.140	→ 3SE2 257-6XX18	0.140
→ 3SE2 243-0XX38	0.140	→ 3SE2 257-6XX38	0.140

3SX3 218	0.020
3SX3 228	0.025
3SX3 217	0.035
3SX3 234	0.035
3SX3 256	0.020
3SX3 233	0.005

For operation, operating speed and travel, see Page 13/92.

→ Positive opening acc. to IEC 60 947-5-1, Appendix K, and DIN VDE 0660 Part 200.

1) Supplied without actuator.

2) For conduit thread adaptors, see page 13/48.

# Limit Switches

## SIRIUS 3SE5 Interlock Switches

### Technical data

#### Benefits

The 3SE5 position switches with separate actuator differ from the previous series through the following new characteristics:

- All enclosure sizes with increased corrosion protection
- All enclosure sizes are optionally available with a LED signaling indicator.
- The three-pole contact block 1 NO + 2 NC is available for all enclosure sizes.
- The plastic enclosure has simple and fast wiring equipment which makes it possible to save from approx. 20 to 25 % of the time when connecting.
- The ASIsafe electric component is integrated for the versions with the AS-Interface connection ([see online](#)); an adapter is not required.

#### Application

Position switches with separate actuator are used where the position of doors, covers or protective grills must be monitored for safety reasons.

The position switch can only be operated with the matching coded actuator. Simple overruling by hand or auxiliary devices is impossible.

Devices are available with enclosure versions to suit the particular ambient conditions. Different control tasks can be performed with the best contact blocks suited for the particular purpose. Dimensions, fixing points of the enclosure are in

accordance with EN 50041 or EN 50047 standards. The devices are suitable for use in any climate.

#### Standards

IEC 60947-5-1 or EN 60947-5-1.

The protective measure of "total insulation" by the molded-plastic enclosure is guaranteed by the use of molded-plastic screw-glands.

#### Safety position switches

For controls according to IEC 60204-1 or EN 60204-1 the devices can be used as a safety position switch. To secure position switches against changes in their position, keyed techniques must be employed on installation.

#### Safety circuits

IEC 60947-5-1 and EN 60947-5-1 require positive opening of the NC contacts, i.e. for the purposes of personal safety, the assured opening of NC contacts is expressly stipulated for the electrical equipment of machines in all safety circuits and marked according to the IEC standard 60947-5-1 with the symbol .

Category 3 according to ISO 13849-1 (EN 954-1) can be attained with a position switch with a separate actuator if the corresponding failsafe evaluation units are selected and correctly installed, e.g. the 3TK28 safety relays or matching units from the ASIsafe, SIMATIC or SINUMERIK product ranges.

Category 4 can be achieved when using an additional position switch.





#### Technical specifications

Type		3SE5 1...-V.., 3SE5 2...-V..	3SE2 257-XX..	3SE2 243-XX..			
<b>General data</b>							
<b>Standards</b>		IEC 60947-5-1, EN 60947-5-1					
<b>Rated insulation voltage <math>U_i</math></b>	V	400	500				
<b>Pollution degree</b> acc. to IEC 60664-1		Class 3	Class 3				
<b>Rated impulse withstand voltage <math>U_{imp}</math></b>	kV	6					
<b>Rated operational voltage <math>U_e</math></b>	V	400 AC; over 300 V AC only equal potential	500 AC; over 380 V AC only equal potential				
<b>Conventional thermal current <math>I_{th}</math></b>	A	6	10				
<b>Rated operational current <math>I_e</math></b>		2-pole	3-pole	1-pole	3-pole		
• With alternating current 50/60 Hz		$I_e/AC-15$	$I_e/AC-15$	$I_e/AC-12$	$I_e/AC-15$	$I_e/AC-12$	$I_e/AC-15$
- At 24 V	A	6	6	10	10	10	10
- At 120 V	A	6	3	10	10	10	10
- At 240 V	A	3	1.5	10	6	10	4
- At 400 V	A	—	—	10	4	10	4
- At 500 V	A	—	—	10	3	10	3
• For direct current		$I_e/DC-13$	$I_e/DC-13$	$I_e/DC-12$	$I_e/DC-13$	$I_e/DC-12$	$I_e/DC-13$
- At 24 V	A	3	3	10	10	10	10
- At 125 V	A	0.55	0.55	—	—	—	—
- At 250 V	A	0.27	0.27	—	—	—	—
- At 110 V	A	—	—	4	1	4	1
- At 220 V	A	—	—	1	0.4	1	0.4
- At 440 V	A	—	—	0.5	0.2	0.5	0.2
<b>Short-circuit protection<sup>1)</sup></b>							
• With DIAZED fuse links, gG operational class	A	6	6				
• With fuse links, quick		—	10				
• With miniature circuit breaker, Char. C	A	1	2	—			
<b>Mechanical endurance</b>		1 × 10 <sup>6</sup> operating cycles					
<b>Electrical endurance</b>							
• With 3RH.1, 3RT contactors in size S00, S0		10 × 10 <sup>6</sup> operating cycles		> 1 × 10 <sup>6</sup> operating cycles			
• For utilization category AC-15 when switching off $I_e/AC-15$ at 240 V		0.1 × 10 <sup>6</sup> operating cycles		0.5 × 10 <sup>6</sup> operating cycles			
<b>Switching frequency</b>		6000 operating cycles/h					
With 3RH.1, 3RT contactors in size S00, S0							
<b>Minimum pull-out force</b> for positive opening	N	20	10		30		



## Configuration

### Operation and operating travel of actuators

<b>Operation by a separate actuator</b>  Positive opening acc. to EN 60947-5-1 $v_{max}$ Max. actuating speed  Direction of operation	<b>Contact blocks</b> Terminal designation acc. to EN 50013	<b>Nominal travel</b>  Contact closed  Contact open Actuator in actuator head: NC is closed
--	--	--

### Separate actuators

#### Standard actuators

Axial and lateral actuation ( $4 \times 90^\circ$ )

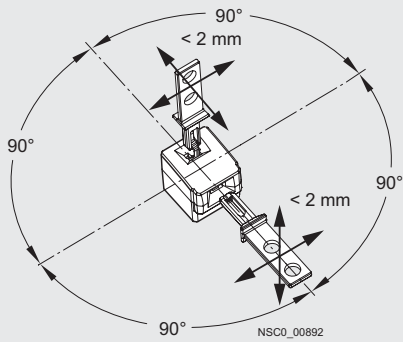

Minimum force required in operating direction 30 N (on retraction)

#### Slow-action contacts

1 NO + 1 NC

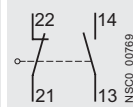

Ident. No. 11

Lateral actuation

3SE5 ...-RV..

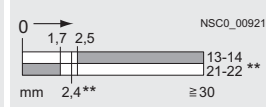

Axial actuation

3SE5 ...-RV..

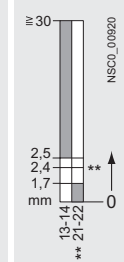

1 NO + 2 NC

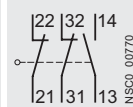

Ident. No. 12

3SE5 ...-QV..

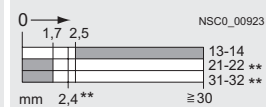

3SE5 ...-QV..

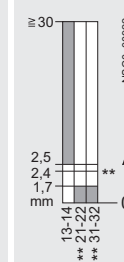

#### Radius actuators (all directions of approach)

Example: direction of approach from the left

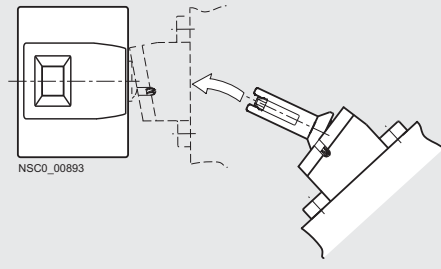

For connector assignment, see page 13/61.

# Limit Switches

## SIRIUS 3SE5 Interlock Switches

3SE5 with separate actuator  
Metal and plastic enclosures

### Dimensional drawings

#### Complete units

Enclosure width 31 mm  
3SE5 23.-.QV40, 3SE5 23.-.RV40

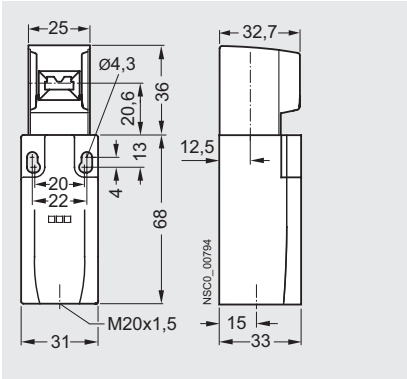

Enclosure width 50 mm  
3SE5 24.-.QV40, 3SE5 24.-.RV40

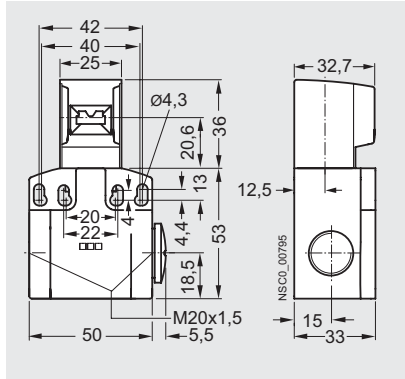

Enclosure width 40 mm  
3SE5 11.-.QV10, 3SE5 11.-.RV10

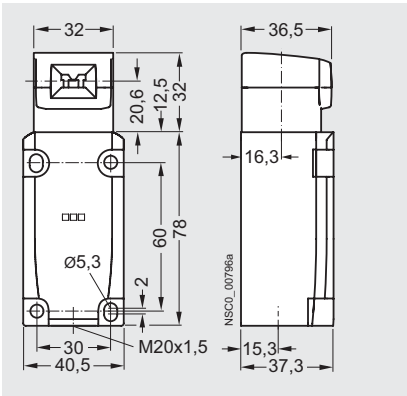

Enclosure width 56 mm  
3SE5 12.-.QV10, 3SE5 12.-.RV10

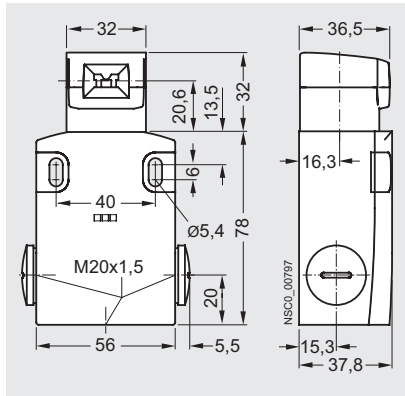

#### Actuators

3SE5 000-0AV01  
standard actuator

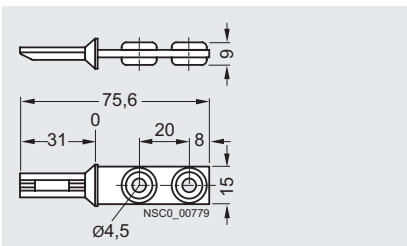

3SE5 000-0AV02  
actuator with vertical fixing

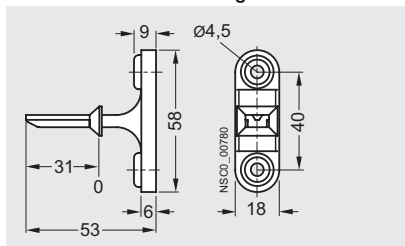

3SE5 000-0AV03  
actuator with horizontal fixing

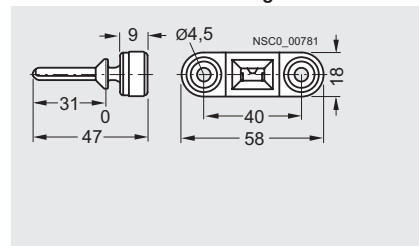

3SE5 000-0AV04  
radius actuator, approach from left

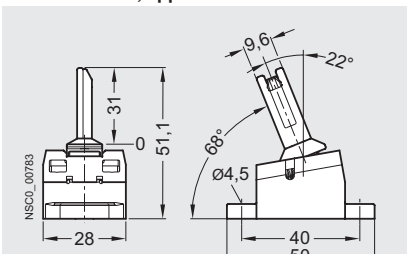

3SE5 000-0AV06  
radius actuator approach from right

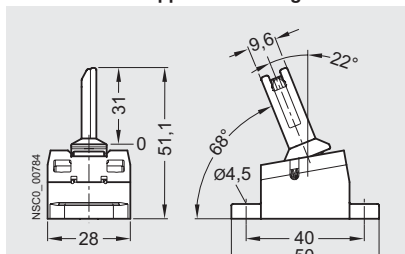

3SE5 000-0AV05  
universal radius actuator

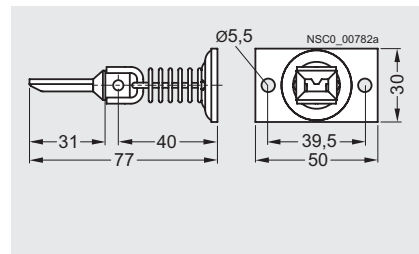

# Mechanical Safety

## SIRIUS 3SE5 Interlock Switches

3SE5 with separate actuator  
Metal and plastic enclosures

1

2

3

4

5

6

7

8

9

10

11

12

13

3SE5 000-0AV07  
universal radius actuator, heavy duty

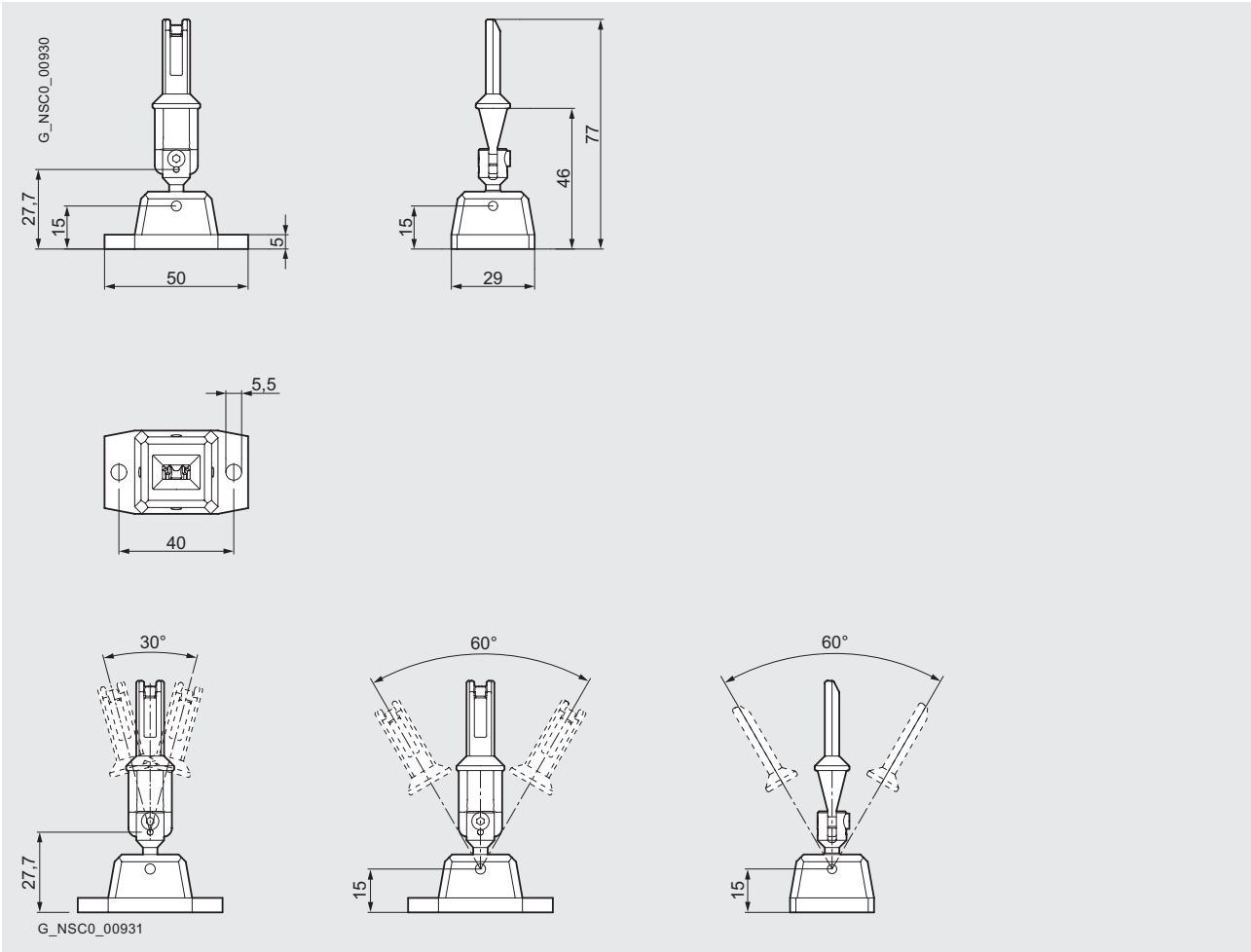



# Limit Switches

## SIRIUS 3SE5 Interlock Switches

**3SE2 with separate actuator**  
Plastic enclosures

### Configuration

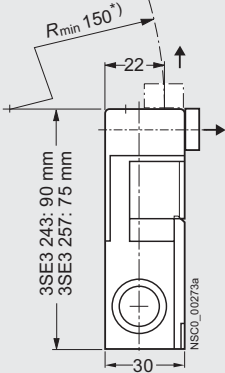
#### Operation and operating travel of actuators

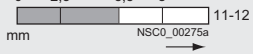
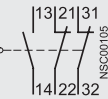
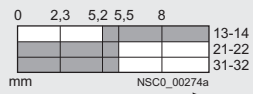
<b>Operation by a separate actuator</b> $v_{max}$ Max. actuating speed → Direction of operation Radius actuation: for all directions of approach	<b>Contact blocks</b> Terminal designation acc. to EN 50013	<b>Nominal travel</b>  Contact closed Contact open Actuator in actuator head: NC is closed	Minimum force required in operating direction on retraction
<b>Separate actuators</b>			
<b>Standard and radius actuators</b>			
Axial and lateral actuation  <p>*) Radius actuator: <math>R_{min} &gt; 38</math> mm.</p>	<b>Slow-action contacts</b> <b>1 NC</b>  Ident. No. <b>01</b>	Lateral actuation <b>3SE2 257-XX..</b>  NSCO_00275a	30 N or 5 N
	<b>1 NO + 2 NC</b>  Ident. No. <b>12</b>	<b>3SE2 243-XX..</b>  NSCO_00274a	30 N or 5 N

### Dimensional drawings

**3SE2 243, lateral and front-end actuation, with 3SX3 218 standard actuator**

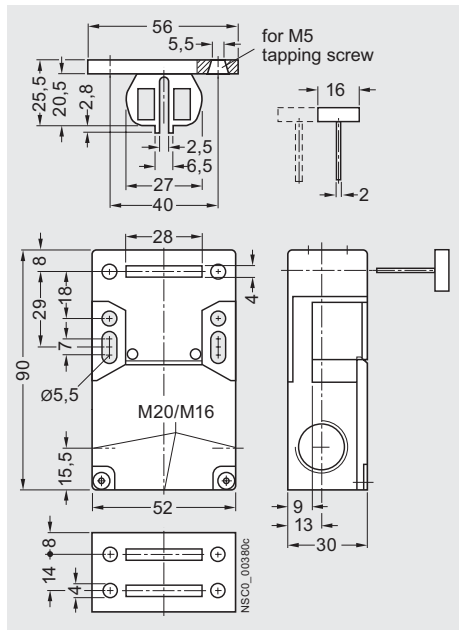

**3SE2 257, lateral and front-end actuation**

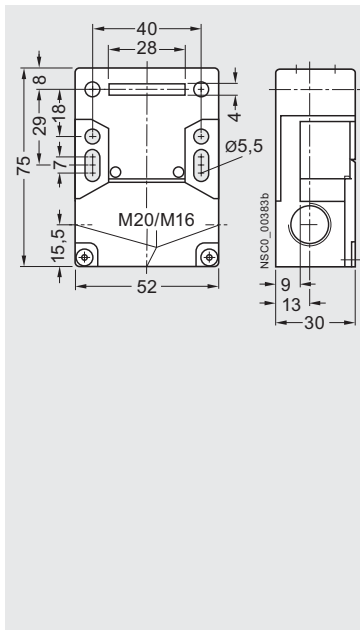

**3SX3 228 universal radius actuator**

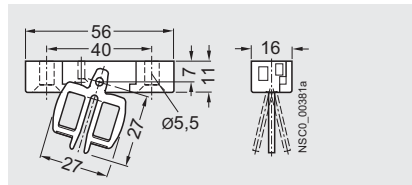

**3SX3 217 actuator with ball locating**

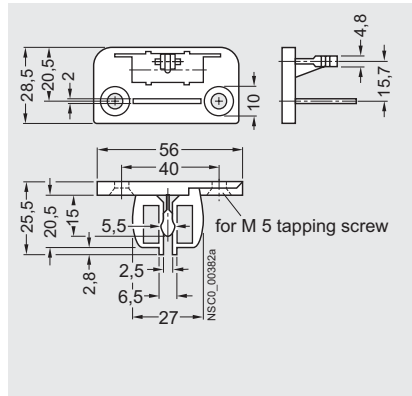

### Overview

The position switches with solenoid interlocking are exceptional, technically safe devices which restrict and prevent an unforeseen or intentional opening of protective doors, protective grilles or other covers as long as a dangerous situation is present (i.e. follow-on motion of the shutdown machine).



The safety position switches with solenoid interlocking are comprised of a switch part with electromechanical interlock and a mechanical actuator which has to be ordered separately.

They are rugged protective devices that enable the greatest possible safety for man and machine.

The position switches with solenoid interlocking are offered in plastic or metal enclosures.

Dimensions (W × H × D):

- 3SE5 3: 54 mm × 185 mm × 43.5 mm,
- 3SE2 8: 90 mm × 100 mm (+ head 41.3 mm) × 45 mm.

### Operation

The actuator head is included in the scope of supply. For actuation from four directions it can be adjusted through 4 × 90°. The 3SE5 3 switches can also be approached from above.

The actuators are not included in the scope of supply of the position switch and must be ordered separately from a choice of six versions to suit the application (see page 13/97).

Actuation data:

- Maximum actuating speed  $v_{\max} = 1.5 \text{ m/s}$
- Minimum actuating speed  $v_{\min} = 0.4 \text{ mm/s}$
- Minimum force in the direction of actuation  $F_{\min} = 30 \text{ N}$

The actuator is encoded. Simple overruling by hand or auxiliary devices is impossible.

### Radius actuators

The position switches with radius actuators are particularly suitable for rotatable protective devices. The movable actuation key allows even small radii to be approached. Damage to the switch and the actuator due to inaccurate approach is prevented.

### Locking devices

A high-grade steel locking device for attaching up to eight padlocks is available for even more safety (see page 13/97).

### Dust protection

A rubber cap to protect the actuator head from contamination is available for operation in dusty environments (see page 13/97).

### Solenoid interlocking

There are two versions for locking the actuator:

- Spring-actuated lock (closed-circuit principle) with various release mechanisms
- Magnetic field lock (open-circuit principle)

The spring-actuated switch is equipped with an auxiliary release for emergency situations or setup mode. Available as options:

- Escape release or
- Emergency release

### Contact blocks

The position switches with solenoid interlocking have one contact block each for:





- Monitoring the actuator or the position of the protective door
- Monitoring the position of the solenoid

The mechanical design of the switch corresponds to the requirements of the failsafe principle according to EN 1088.

### Optical signaling equipment

The position switches with solenoid interlocking are available with an optional optical signaling device.

The signaling device indicates the switch position of the lock and the protective device optically by means of 2 LEDs on the front.

Protective device	Interlock	Display	Meaning
Closed	Released	 <sup>1)</sup>  <sup>2)</sup>	Actuator free to be pulled
Closed	Closed	 <sup>2)</sup>	Actuator locked
Open	Open	 <sup>1)</sup>	Actuator pulled

### Note:

*The voltage of the LEDs at the monitored contacts must be the same as the operational voltage of the solenoid (same potential).*

<sup>1)</sup> Yellow LED.

<sup>2)</sup> Green LED.

# Limit Switches

## SIRIUS 3SE5 Interlock Switches

### 3SE5 / 3SE2 with solenoid locking General data

#### Benefits

The new generation of 3SE5 3 position switches offers:

- More safety through higher locking forces:
  - 1300 N with plastic enclosure
  - 2600 N with metal enclosure
- Various release mechanisms: lock release, escape release and emergency release
- Two contact blocks each with three contacts as standard equipment, hence fewer versions needed
- Same dimensions for all enclosure variants: Plastic, metal or with integrated ASIsafe
- An extensive range of actuators
- An optional LED status display 24 V DC, 115 V AC or 230 V AC for all switch variants

#### Application

The position switches with solenoid interlocking are exceptional, technically safe devices which restrict and prevent an unforeseen or intentional opening of protective doors, protective grilles or other covers as long as a dangerous situation is present (i.e. follow-on motion of the shutdown machine).

The safety position switches with solenoid interlocking have the following functions:

- Enabling the machine or process with closed and locked protective device
- Locking the machine or process with opened protective device
- Position monitoring of the protective device and solenoid

#### Standards

The switches comply with the standards IEC 60947-1 (Low-Voltage Controlgear, General) and IEC 60947-5-1 (Electromechanical Control Devices).

The mechanical design of the switch corresponds to the requirements of the failsafe principle according to EN 1088.

#### Approvals

The switches are approved for use with locking devices according to EN 1088 and EN 292, Parts 1 and 2.

3SE5 3 position switches with solenoid interlocking bear the VDE test mark for tested according to GS-ET19 (Test Principles of the German Trade Association for Locking Devices with Electromagnetic Interlocks).

The 3SE2 8 metal-enclosed position switches with solenoid interlocking have been awarded a test certificate from the BIA (Berufsgenossenschaftliches Institut für Arbeitssicherheit).

Category 3 according to ISO 13849-1 (EN 954-1) can be attained with a position switch with solenoid interlocking if the corresponding failsafe evaluation units are selected and correctly installed, e. g. the 3TK28 safety relays or matching units from the ASIsafe, SIMATIC or SINUMERIK product ranges.

Category 4 can be achieved when using an additional position switch.

They are approved according to UL 508, UL 50 and UL 746-C.

#### Solenoid interlocking

The separate actuator operates in a similar way to the coding of a key and protects against manipulation. It transmits the locking force to the protective device and helps to monitor its position.

There are two versions of locking:

#### Spring-actuated lock (closed-circuit principle)

- In the standard version, the position switch locks by means of spring force and releases by means of electromagnetic force. In the case of voltage failure, it reliably prevents the protective device from opening when machine parts are still moving.
- The switch is equipped with an auxiliary release for emergency situations or setup mode.
- An auxiliary release which can be secured with a lock to prevent misuse is available as a version.



Auxiliary release

Auxiliary release with lock

The new 3SE5 3 position switches are also available with an escape release or an emergency release.

- Personnel working inside the hazard zone can use the escape release feature to manually release the interlock without tools from the escape side (hazardous area side) so that they can exit the hazard area. An intentional act (in this case pulling the gray actuator) is required to release the locking mechanism and restore the normal operating state.
- The emergency release enables someone in an emergency situation to manually release the interlock without tools from the access side (outside the hazardous area). Releasing the lock and restoring the normal operating state must require effort which is comparable to repair activity, in this case disassembly of the red actuator and resetting the mechanical lock.

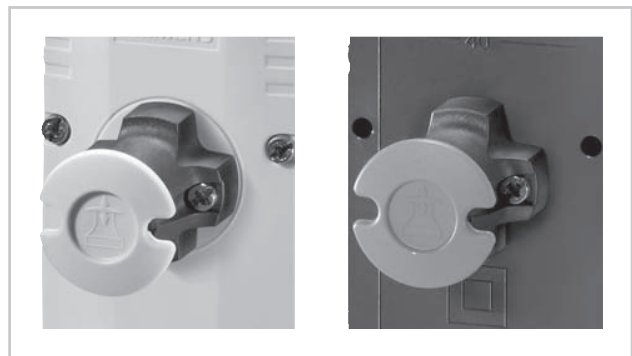

Escape release from the front

Emergency release from the back

#### Magnetic field lock (open-circuit principle)

- The second version offers locking by means of electromagnetic force and release by means of spring force. This version has an advantage when it is necessary to quickly access the machine after a power failure occurs, or in the case of very short overtravel times.

# Mechanical Safety

## SIRIUS 3SE5 Interlock Switches

3SE5, plastic enclosures  
with locking force up to 1200 N







1  
2  
3  
4  
5  
6  
7  
8  
9  
10  
11  
12  
13

### Selection and ordering data

6 slow-action contacts · 5 directions of approach · Cable entry 3 × M20 × 1.5 · Degree of protection IP66/IP67  
Locking force 1300 N (1000 N according to GS-ET 19)

Interlock <sup>1)</sup>	LEDs	Solenoid Rated opera- tional voltage	DT	Complete units Position monitoring: Actuators: 1 NO + 2 NC Solenoid: 1 NO + 2 NC	<input type="checkbox"/>	PU (UNIT, SET, M)	PS*	PG	Weight per PU approx.
		V		Order No.	Price \$ per PU				kg

### 1300 N locking force · Enclosure width 54 mm

Image	Description	Rated operational voltage	DT	Order No.	Price \$ per PU	PU (UNIT, SET, M)	PS*	PG	Weight per PU approx. kg
	<b>Spring-actuated locks</b>								
	• With auxiliary release	--	24 DC	⊕ A	<b>3SE5 322-0SD21</b>	1	1 unit	102	0.590
		--	115 AC	⊕ B	<b>3SE5 322-0SD22</b>	1	1 unit	102	0.590
		--	230 AC	⊕ B	<b>3SE5 322-0SD23</b>	1	1 unit	102	0.590
		Yellow/Green	24 DC	⊕ A	<b>3SE5 322-1SD21</b>	1	1 unit	102	0.590
		Yellow/Green	115 AC	⊕ B	<b>3SE5 322-2SD22</b>	1	1 unit	102	0.590
	Yellow/Green	230 AC	⊕ B	<b>3SE5 322-3SD23</b>	1	1 unit	102	0.590	
	• With auxiliary release	--	24 DC	⊕ ▶	<b>3SE5 322-0SE21</b>	1	1 unit	102	0.745
	With lock	--	115 AC	⊕ B	<b>3SE5 322-0SE22</b>	1	1 unit	102	0.745
		--	230 AC	⊕ B	<b>3SE5 322-0SE23</b>	1	1 unit	102	0.745
		Yellow/Green	24 DC	⊕ B	<b>3SE5 322-1SE21</b>	1	1 unit	102	0.745
		Yellow/Green	115 AC	⊕ B	<b>3SE5 322-2SE22</b>	1	1 unit	102	0.745
		Yellow/Green	230 AC	⊕ B	<b>3SE5 322-3SE23</b>	1	1 unit	102	0.745
	• With escape release from the front	--	24 DC	⊕ B	<b>3SE5 322-0SF21</b>	1	1 unit	102	0.590
		--	115 AC	⊕ B	<b>3SE5 322-0SF22</b>	1	1 unit	102	0.590
		--	230 AC	⊕ B	<b>3SE5 322-0SF23</b>	1	1 unit	102	0.590
		Yellow/Green	24 DC	⊕ B	<b>3SE5 322-1SF21</b>	1	1 unit	102	0.590
		Yellow/Green	115 AC	⊕ B	<b>3SE5 322-2SF22</b>	1	1 unit	102	0.590
		Yellow/Green	230 AC	⊕ B	<b>3SE5 322-3SF23</b>	1	1 unit	102	0.590
	• With escape release from the front and emergency release from back	--	24 DC	⊕ B	<b>3SE5 322-0SL21</b>	1	1 unit	102	0.590
	• For ambient temperature up to to -40 °C	--	24 DC	⊕ B	<b>3SE5 322-0SL21-1AJ0</b>	1	1 unit	102	0.590
	• With escape release from the back and auxiliary release from the front	--	24 DC	⊕ B	<b>3SE5 322-0SG21</b>	1	1 unit	102	0.590
		--	115 AC	⊕ B	<b>3SE5 322-0SG22</b>	1	1 unit	102	0.590
		--	230 AC	⊕ B	<b>3SE5 322-0SG23</b>	1	1 unit	102	0.590
		Yellow/Green	24 DC	⊕ ▶	<b>3SE5 322-1SG21</b>	1	1 unit	102	0.590
		Yellow/Green	115 AC	⊕ B	<b>3SE5 322-2SG22</b>	1	1 unit	102	0.590
		Yellow/Green	230 AC	⊕ B	<b>3SE5 322-3SG23</b>	1	1 unit	102	0.590
	• With escape release from the back and auxiliary release with lock from the front	--	24 DC	⊕ B	<b>3SE5 322-0SH21</b>	1	1 unit	102	0.745
	• With emergency release from the back and auxiliary release from the front	--	24 DC	⊕ B	<b>3SE5 322-0SJ21</b>	1	1 unit	102	0.745
		--	115 AC	⊕ B	<b>3SE5 322-0SJ22</b>	1	1 unit	102	0.745
		--	230 AC	⊕ B	<b>3SE5 322-0SJ23</b>	1	1 unit	102	0.745
		Yellow/Green	24 DC	⊕ B	<b>3SE5 322-1SJ21</b>	1	1 unit	102	0.745
		Yellow/Green	115 AC	⊕ B	<b>3SE5 322-2SJ22</b>	1	1 unit	102	0.745
		Yellow/Green	230 AC	⊕ B	<b>3SE5 322-3SJ23</b>	1	1 unit	102	0.745
	<b>Magnetic field locks</b>	--	24 DC	⊕ ▶	<b>3SE5 322-0SB21</b>	1	1 unit	102	0.590
		--	115 AC	⊕ B	<b>3SE5 322-0SB22</b>	1	1 unit	102	0.590
		--	230 AC	⊕ B	<b>3SE5 322-0SB23</b>	1	1 unit	102	0.590
	Yellow/Green	24 DC	⊕ A	<b>3SE5 322-1SB21</b>	1	1 unit	102	0.590	
	Yellow/Green	115 AC	⊕ B	<b>3SE5 322-2SB22</b>	1	1 unit	102	0.590	
	Yellow/Green	230 AC	⊕ B	<b>3SE5 322-3SB23</b>	1	1 unit	102	0.590	

⊕ Positive opening according to IEC 60947-1, Appendix K.

1) Supplied without actuator. Please order separately (see page 13/97).

For 1/2" NPT adaptors and cable glands, see page 13/48.

# Limit Switches

## SIRIUS 3SE5 Interlock Switches







**3SE5, metal enclosures  
with locking force up to 2000 N**

### Selection and ordering data

6 slow-action contacts · 5 directions of approach · Cable entry 3 × M20 × 1.5 · Degree of protection IP66/IP67  
Locking force 2600 N (2000 N according to GS-ET 19)

Interlock <sup>1)</sup>	LEDs	Solenoid Rated opera- tional voltage	DT	Complete units Position monitoring: Actuators: 1 NO + 2 NC Solenoid: 1 NO + 2 NC	<input type="checkbox"/>	PU (UNIT, SET, M)	PS*	PG	Weight per PU approx.
		V		Order No.	Price \$ per PU				kg

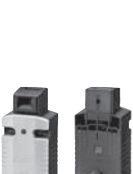
### 2600 N locking force · Enclosure width 54 mm

Spring-actuated locks												
	• With auxiliary release	--	24 DC	⊕ ▶	<b>3SE5 312-0SD11</b>		1	1 unit	102	1.030		
		--	115 AC	⊕ ▶	<b>3SE5 312-0SD12</b>		1	1 unit	102	1.030		
		--	230 AC	⊕ B	<b>3SE5 312-0SD13</b>		1	1 unit	102	1.030		
		Yellow/Green	24 DC	⊕ B	<b>3SE5 312-1SD11</b>		1	1 unit	102	1.040		
		Yellow/Green	115 AC	⊕ ▶	<b>3SE5 312-2SD12</b>		1	1 unit	102	1.040		
		Yellow/Green	230 AC	⊕ B	<b>3SE5 312-3SD13</b>		1	1 unit	102	1.040		
	• With auxiliary release With lock	--	24 DC	⊕ B	<b>3SE5 312-0SE11</b>		1	1 unit	102	1.180		
		--	115 AC	⊕ B	<b>3SE5 312-0SE12</b>		1	1 unit	102	1.180		
		--	230 AC	⊕ B	<b>3SE5 312-0SE13</b>		1	1 unit	102	1.180		
			48 AC/DC	⊕ C	<b>3SE5 312-0SE14</b>		1	1 unit	102	1.180		
		Yellow/Green	24 DC	⊕ B	<b>3SE5 312-1SE11</b>		1	1 unit	102	1.180		
		Yellow/Green	115 AC	⊕ B	<b>3SE5 312-2SE12</b>		1	1 unit	102	1.180		
	• With escape release from the front	--	24 DC	⊕ B	<b>3SE5 312-0SF11</b>		1	1 unit	102	1.180		
		--	115 AC	⊕ B	<b>3SE5 312-0SF12</b>		1	1 unit	102	1.180		
		--	230 AC	⊕ B	<b>3SE5 312-0SF13</b>		1	1 unit	102	1.180		
		Yellow/Green	24 DC	⊕ B	<b>3SE5 312-1SF11</b>		1	1 unit	102	1.180		
		Yellow/Green	115 AC	⊕ B	<b>3SE5 312-2SF12</b>		1	1 unit	102	1.180		
		Yellow/Green	230 AC	⊕ B	<b>3SE5 312-3SF13</b>		1	1 unit	102	1.180		
	• With escape release from the back and auxiliary release from the front	--	24 DC	⊕ B	<b>3SE5 312-0SG11</b>		1	1 unit	102	1.175		
		--	115 AC	⊕ B	<b>3SE5 312-0SG12</b>		1	1 unit	102	1.175		
		--	230 AC	⊕ B	<b>3SE5 312-0SG13</b>		1	1 unit	102	1.175		
		Yellow/Green	24 DC	⊕ ▶	<b>3SE5 312-1SG11</b>		1	1 unit	102	1.180		
		Yellow/Green	115 AC	⊕ B	<b>3SE5 312-2SG12</b>		1	1 unit	102	1.180		
		Yellow/Green	230 AC	⊕ B	<b>3SE5 312-3SG13</b>		1	1 unit	102	1.180		
	• With escape release from the back and auxiliary release with lock from the front	--	24 DC	⊕ B	<b>3SE5 312-0SH11</b>		1	1 unit	102	1.180		
	• With emergency release from the back and auxiliary release from the front	--	24 DC	⊕ B	<b>3SE5 312-0SJ11</b>		1	1 unit	102	1.180		
		--	115 AC	⊕ B	<b>3SE5 312-0SJ12</b>		1	1 unit	102	1.180		
		--	230 AC	⊕ B	<b>3SE5 312-0SJ13</b>		1	1 unit	102	1.180		
		Yellow/Green	24 DC	⊕ B	<b>3SE5 312-1SJ11</b>		1	1 unit	102	1.180		
		Yellow/Green	115 AC	⊕ B	<b>3SE5 312-2SJ12</b>		1	1 unit	102	1.180		
Yellow/Green		230 AC	⊕ B	<b>3SE5 312-3SJ13</b>		1	1 unit	102	1.180			
	<b>Magnetic field locks</b>			--	24 DC	⊕ ▶	<b>3SE5 312-0SB11</b>		1	1 unit	102	1.030
		--	115 AC	⊕ B	<b>3SE5 312-0SB12</b>		1	1 unit	102	1.030		
		--	230 AC	⊕ B	<b>3SE5 312-0SB13</b>		1	1 unit	102	1.030		
		Yellow/Green	24 DC	⊕ B	<b>3SE5 312-1SB11</b>		1	1 unit	102	1.040		
		Yellow/Green	115 AC	⊕ B	<b>3SE5 312-2SB12</b>		1	1 unit	102	1.040		
		Yellow/Green	230 AC	⊕ B	<b>3SE5 312-3SB13</b>		1	1 unit	102	1.040		

⊕ Positive opening according to IEC 60947-5-1, Appendix K.

1) Supplied without actuator. Please order separately (see page 13/97).

For 1/2" NPT adaptors and cable glands, see page 13/48.



# Mechanical Safety

## SIRIUS 3SE5 Interlock Switches

3SE5, metal and plastic enclosures  
Accessories

1

2

3

4

5

6

7

8

9

10

11

12

13

### Selection and ordering data

Version	DT	Order No.	List Price \$ per PU	PU (UNIT, SET, M)	PS*	PG	Weight per PU approx. kg	
<b>Actuators for 3SE5 <sup>1)</sup></b>								
 3SE5 000-0AV01		Standard actuators, length 75.6 mm	A	<b>3SE5 000-0AV01</b>	1	1 unit	102 0.040	
 3SE5 000-0AV02		With vertical fixing, length 53 mm	A	<b>3SE5 000-0AV02</b>	1	1 unit	102 0.070	
 3SE5 000-0AV03		With transverse fixing, length 47 mm	A	<b>3SE5 000-0AV03</b>	1	1 unit	102 0.070	
 3SE5 000-0AV04		Radius actuators, length 51 mm • Direction of approach from the left • Direction of approach from the right	A	<b>3SE5 000-0AV04</b>	1	1 unit	102 0.070	
	A		<b>3SE5 000-0AV06</b>	1	1 unit	102 0.070		
 3SE5 000-0AV05		Universal radius actuators, • Length 77 mm • Length 77 mm, tab rotated 90°	A	<b>3SE5 000-0AV05</b>	1	1 unit	102 0.090	
	A		<b>3SE5 000-0AV05-1AA6</b>	1	1 unit	102 0.090		
 3SE5 000-0AV07		Universal radius actuators, heavy-duty • Length 67 mm • Length 77 mm	A	<b>3SE5 000-0AV07-1AK2</b>	1	1 unit	102 0.120	
	A		<b>3SE5 000-0AV07</b>	1	1 unit	102 0.090		
<b>Optional accessories for 3SE5</b>								
 3SE5 000-0AV08-1AA2		<b>Protective caps</b> made of black rubber for the actuator head, to protect the actuator openings from contamination	B	<b>3SE5 000-0AV08-1AA2</b>	1	1 unit	102 0.010	
 3SE5 000-0AV08-1AA3		<b>Blocking inserts</b> , high-grade steel, for actuator head, for up to 8 padlocks	B	<b>3SE5 000-0AV08-1AA3</b>	1	1 unit	102 0.065	
<b>Connections for 3SE5, 3SE2</b>								
 3SY3 127		<b>Connector sockets (4-pole), M12, fixed for M20 x 1.5</b> For max. 250 V, 4 A With 0.25 mm <sup>2</sup> connecting cable, plastic, degree of protection IP67, ambient temperature -40 to +85 °C	B	<b>3SY3 127</b>	1	1 unit	102 0.010	
	 3RX8 000		<b>Cable boxes (4-pole), M12, non-adjustable</b> With terminal compartment, can be pre-assembled	A	<b>3RX8 000-0CB45</b>	1	1 unit	574 0.015
			<b>Angular cable boxes (4-pole), M12</b> With terminal compartment, can be pre-assembled	A	<b>3RX8 000-0CC45</b>	1	1 unit	574 0.015
 3SX9 926		<b>Connector sockets (5-pole), M12 for M20 x 1.5</b> For max. 125 V, 4 A With 0.25 mm <sup>2</sup> connecting cable, plastic, degree of protection IP67, ambient temperature -40 to +85 °C	B	<b>3SY3 128</b>	1	1 unit	102 0.010	
		<b>Cable boxes (5-pole), M12</b> With terminal compartment, can be pre-assembled	A	<b>3RX8 000-0CB55</b>	1	1 unit	574 0.016	
		<b>Angular cable boxes (5-pole), M12</b> With terminal compartment, can be pre-assembled	A	<b>3RX8 000-0CC55</b>	1	1 unit	574 0.016	
		<b>Cable glands M20 x 1.5</b> Plastic	A	<b>3SX9 926</b>	1	1 unit	102 0.010	

1) See page 13/90 for dimensions drawings.

# Limit Switches

## SIRIUS 3SE5 Interlock Switches

### 3SE5 / 3SE2 with solenoid locking

#### Technical specifications

Type		3SE5 322	3SE5 312	3SE2 83, 3SE2 84
<b>General data</b>				
<b>Standards</b>		IEC 60947-5-1, EN 60947-5-1		
<b>Rated insulation voltage <math>U_i</math></b>	V	250		
<b>Degree of pollution</b> acc. to EN 60664-1		Class 3		
<b>Rated impulse withstand voltage <math>U_{imp}</math></b>	kV	4		6
<b>Rated operational voltage <math>U_e</math></b>				
• DC	V	24		24
• AC 50/60 Hz	V	230		110 ... 130 230
<b>Conventional thermal current <math>I_{th}</math></b>	A	6		10
<b>Rated operational current <math>I_e</math></b>				
• With alternating current 50/60 Hz		$I_e$ /AC-15 or B300		$I_e$ /AC-12 $I_e$ /AC-15
- At 24 V	A	6		10 4
- At 120 V	A	3		10 4
- At 230 V	A	1.5		10 4
• For direct current		$I_e$ /DC-13 or Q300		$I_e$ /DC-12 $I_e$ /DC-13
- At 24 V	A	3		10 3
- At 60 V		--		5 1.5
- At 110 V		--		2.5 0.7
- At 125 V	A	0.55		-- --
- At 220 V		--		1 0.3
- At 250 V	A	0.27		-- --
<b>Magnet</b>				
• Locking force, max.	N	1300	2600	1820
• Locking force acc. to GS-ET 19	N	1000	2000	1400
• Power consumption at $U_c$	W	3.5		5.2
<b>Short-circuit protection<sup>1)</sup></b>				
• With DIAZED fuse links, operational class gG	A	6		6
• Characteristic quick		--		10
• With miniature circuit breaker, Char. C	A	0.5		--
<b>Mechanical endurance</b>		1 × 10 <sup>6</sup> operating cycles		1 × 10 <sup>6</sup> operating cycles
<b>Electrical endurance</b>				
• With 3RH11, 3RT10 16 to 3RT10 26 contactors		1 × 10 <sup>6</sup> operating cycles		1 × 10 <sup>6</sup> operating cycles
• For AC-15 utilization category		1 × 10 <sup>5</sup> operating cycles, when interrupting $I_e$ /AC-15 at 230 V		0.5 × 10 <sup>6</sup> operating cycles, when interrupting $I_e$ /AC-15 at 230 V
• For DC-13 utilization category		With DC current the contact endurance depends not only on the breaking current but also on the voltage, the circuit inductance and the speed of switching. No generally valid information can be given.		
<b>Switching frequency</b>		6 × 10 <sup>3</sup> operating cycles/h		
With 3RH11, 3RT10 16 to 3RT10 26 contactors				
<b>Shock resistance</b> acc. to IEC 60068-2-27		30 g/11 ms		--

Type		3SE5 322	3SE5 312	3SE2 83, 3SE2 84
<b>Enclosure</b>				
<b>Enclosure material</b>		Ultramid A3X2G7	Zinc diecasting GD Zn Al4 Cu1	Aluminum (GD - AISi 12)
<b>Degree of protection</b> acc. to EN 60529		IP66/IP67		IP67
<b>Ambient temperature</b>				
• During operation	°C	-25 ... +60		-30 ... +70
• During storage, transport	°C	-40 ... +80		--
<b>Mounting position</b>		Any		
<b>Connection</b>				
<b>Cable entry</b>		M 20 × 1.5		M 20 × 1.5
<b>Conductor cross-sections</b>				
• Solid	mm <sup>2</sup>	1 × (0.5 ... 1.5)		2 × 2.5
• Finely stranded with end sleeve	mm <sup>2</sup>	2 × (0.5 ... 0.75)		2 × 1.5
<b>Protective conductor connection</b>			M3.5	
Inside enclosure				

<sup>1)</sup> Without any welds according to IEC 60947-5-1.

## Schematics

### 3SE5

#### Monitoring the actuator:

Slow-action contacts 1 NO + 2 NC

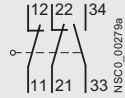

#### Monitoring the solenoid:

Slow-action contacts 1 NO + 2 NC

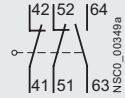

## Configuration

### Operation and operating travel of actuators

#### Operation by a separate actuator

- ⊕ Positive opening acc. to EN 60947-5-1
- $V_{max}$  Max. actuating speed
- Direction of operation

#### Contact blocks

Terminal designation acc. to EN 50013

#### Nominal travel

- Contact closed
- Contact open
- Actuator in actuator head: NC is closed

### Separate actuators with solenoid interlocking

#### Standard actuators

Axial and lateral actuation ( $4 \times 90^\circ$ )

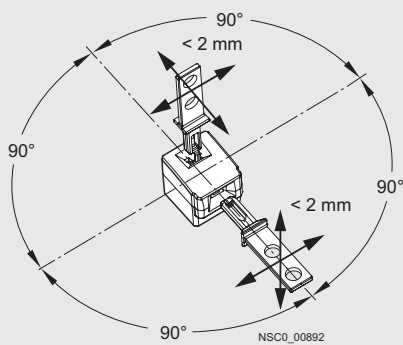

Minimum force required in operating direction 30 N (on retraction)

#### Radius actuators (all directions of approach)

Example: Direction of approach from the left

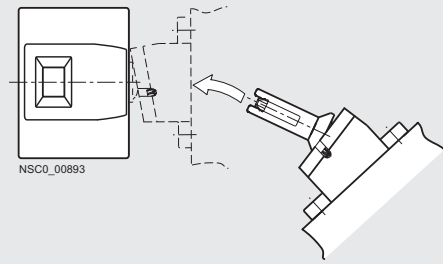

For connector socket assignment, see page 13/61.

#### Slow-action contacts

1 NO + 2 NC

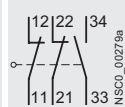

Ident. No. 12

#### Lateral actuation

3SE5 3...-S...

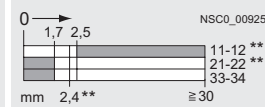

#### Axial actuation

3SE5 3...-S...

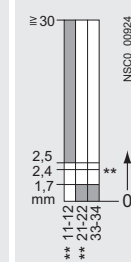



### Overview

3SE5 hinge switches have the same enclosures as the standard switches (modular system).



Hinge switches

### Design

#### Enclosure sizes

The 3SE5 switches are available as complete units in two enclosure sizes:

- Plastic enclosures according to EN 50047, 31 mm wide, IP65, 1 cable entry
- Metal enclosures according to EN 50047, 31 mm wide, IP66/IP67, 1 cable entry
- Plastic and metal enclosures according to EN 50041, 40 mm wide, IP66/IP67, 1 cable entry

#### Enclosure versions

Various basic versions can be selected for the enclosures:

- Available with two or three-pole contact blocks designed as snap-action contacts
- Metal enclosures for explosion protection (ATEX) ([see online](#))
- AS-Interface version with integrated ASIsafe electronics for all enclosure designs ([see online](#))

For a description of the basic switches, [see page 13/6](#).

#### Operating mechanism

The hinge switches are provided for mounting on hinges. The actuator head is included in the scope of supply. There are two versions:

- Operating mechanism with hollow shaft, inner diameter 8 mm, outer 12 mm
- Operating mechanism with solid shaft, diameter 10 mm

### Benefits

The 3SE5 hinge switches differ from the previous series through the following new characteristics:

- All actuators can be turned around the axis in increments of 22.5° ([see picture on page 13/6](#)).
- The new three-pole contact block 1 NO + 2 NC is available for all enclosure sizes ([see picture on page 13/7](#)).
- The plastic enclosure with a width of 31 mm has simple and fast wiring equipment which makes it possible to save from approx. 20 to 25 % of the time when connecting ([see picture on page 13/7](#)).
- The ASIsafe electric component is integrated for the versions with the AS-Interface connection ([see online](#)); an additional adapter is not required.

### Application

The hinge switches are used in those areas where the position of swiveling protective devices such as doors or flaps must be monitored. With these switches, the position of the doors and hinge switches is converted into electric signals. The switches allow shutdown and signaling without delay in the event of a small opening angle through the snap-action contacts with an operating angle of 10°.

Devices are available with enclosure versions to suit the particular ambient conditions. Different control tasks can be performed with the best contact blocks suited for the particular purpose. Dimensions and fixing points of the enclosures are in accordance with EN 50041 or EN 50047 standards.

The devices are suitable for use in any climate.

#### Standards

IEC 60947-5-1 or EN 60947-5-1.

The protective measure of "total insulation" by the molded-plastic enclosure is guaranteed by the use of molded-plastic screw-glands.

#### Safety position switches

For controls according to IEC 60204-1 or EN 60204-1 the devices can be used as a safety position switch. To secure position switches against changes in their position, keyed techniques must be employed on installation.

#### Safety circuits

IEC 60947-5-1 and EN 60947-5-1 require positive opening of the NC contacts, i.e. for the purposes of personal safety, the assured opening of NC contacts is expressly stipulated for the electrical equipment of machines in all safety circuits and marked according to IEC 60947-5-1 with the symbol

Category 4 according to EN 954-1 can be attained with the 3SE5 hinge switches with if the corresponding failsafe evaluation units are selected and correctly installed, e.g. the 3TK28 safety relays or matching devices from the ASIsafe, SIMATIC or SINUMERIK product ranges.

# Mechanical Safety

## SIRIUS 3SE5 Hinge Switches

3SE5, plastic enclosures  
Enclosure width 31 mm / 40 mm

### Selection and ordering data

#### Complete units

2 or 3 contacts · Degree of protection IP65 (31 mm) or IP67/IP68 (40 mm) · Cable entry M20 × 1.5

Version	Snap-action contacts	DT	Complete units	<input type="checkbox"/>	PU (UNIT, SET, M)	PS*
			<b>Configurator</b>			
		Order No.	Price per PU			

#### Plastic enclosures · Enclosure width 31 mm acc. to EN 50047



With hollow shaft

##### With hollow shaft

Operating angle 10°  
Operating angle 10°

1 NO + 1 NC → B  
1 NO + 2 NC → B

**3SE5 232-0HU21**  
**3SE5 232-0LU21**

1 1 unit  
1 1 unit



With solid shaft

##### With solid shaft

Operating angle 10°  
Operating angle 10°

1 NO + 1 NC → B  
1 NO + 2 NC → B

**3SE5 232-0HU22**  
**3SE5 232-0LU22**

1 1 unit  
1 1 unit

#### Plastic enclosures · Enclosure width 40 mm acc. to EN 50041



With hollow shaft

##### With hollow shaft

Operating angle 10°

1 NO + 2 NC → B

**3SE5 132-0LU21**

1 1 unit



With solid shaft

##### With solid shaft

Operating angle 10°

1 NO + 2 NC → B

**3SE5 132-0LU22**

1 1 unit

For online configurator see [www.siemens.com/sirius/configurators](http://www.siemens.com/sirius/configurators).

Positive opening according to IEC 60947-5-1, Appendix K.

#### Spare parts

Version	DT	Order No.	Price per PU	PU (UNIT, SET, M)	PS*
---------	----	-----------	--------------	-------------------------	-----

#### Actuator heads



With hollow shaft

##### With hollow shaft

Operating angle 10°

B

**3SE5 000-0AU21**

1 1 unit



With solid shaft

##### With solid shaft

Operating angle 10°

B

**3SE5 000-0AU22**

1 1 unit

#### Note:

The respective actuators are included in the scope of supply for the complete units.

# Mechanical Safety

## SIRIUS 3SE5 Hinge Switches

3SE5, metal enclosures  
Enclosure width 31 mm / 40 mm

1  
2  
3  
4  
5  
6  
7  
8  
9  
10  
11  
12  
13

### Selection and ordering data

#### Complete units

3 contacts · Degree of protection IP66/IP67 · Cable entry M20 × 1.5

Version	Snap-action contacts	DT	Complete units	<input type="checkbox"/> PU (UNIT, SET, M)
			<b>Configurator</b>	
		Order No.	Price per PU	

#### Metal enclosures · Enclosure width 31 mm acc. to EN 50047



With hollow shaft

Version	Snap-action contacts	DT	Complete units	PU (UNIT, SET, M)
<b>With hollow shaft</b> Operating angle 10°	1 NO + 2 NC	⊕ B	<b>3SE5 212-0LU21</b>	1



With solid shaft

Version	Snap-action contacts	DT	Complete units	PU (UNIT, SET, M)
<b>With solid shaft</b> Operating angle 10°	1 NO + 2 NC	⊕ B	<b>3SE5 212-0LU22</b>	1

#### Metal enclosures · Enclosure width 40 mm acc. to EN 50041



With hollow shaft

Version	Snap-action contacts	DT	Complete units	PU (UNIT, SET, M)
<b>With hollow shaft</b> Operating angle 10°	1 NO + 2 NC	⊕ B	<b>3SE5 112-0LU21</b>	1



With solid shaft

Version	Snap-action contacts	DT	Complete units	PU (UNIT, SET, M)
<b>With solid shaft</b> Operating angle 10°	1 NO + 2 NC	⊕ B	<b>3SE5 112-0LU22</b>	1

For online configurator see [www.siemens.com/sirius/configurators](http://www.siemens.com/sirius/configurators) .

⊕ Positive opening according to IEC 60947-5-1, Appendix K.

#### Spare parts

Version	DT	Order No.	Price per PU	PU (UNIT, SET, M)	PS*
---------	----	-----------	--------------	-------------------	-----



With hollow shaft

Version	DT	Order No.	Price per PU	PU (UNIT, SET, M)	PS*
<b>With hollow shaft</b> Operating angle 10°	B	<b>3SE5 000-0AU21</b>		1	1 unit



With solid shaft

Version	DT	Order No.	Price per PU	PU (UNIT, SET, M)	PS*
<b>With solid shaft</b> Operating angle 10°	B	<b>3SE5 000-0AU22</b>		1	1 unit

#### Note:

The respective actuators are included in the scope of supply for the complete units.

# Mechanical Safety

## 3SE2 Hinge Switches

### 3SE2, plastic enclosures with integrated hinge

#### Overview

The 3SE2 283 hinge switches are particularly suitable for use in doors and flaps of machines that must be closed to ensure the safety of operating personnel. Their thin profile and compact design allow them to be directly mounted on a hinged protective cover and the stable frame.

#### Benefits

- Easy mounting through use of versions with integrated hinge
- Versions with small operating angle of 4°
- Protection against personal injury provided by positively driven NC contacts according to IEC 60947-5-1
- Simultaneous shutdown and reporting by 1 NO + 2 NC contacts

#### Selection and ordering data

3 contacts · Degree of protection IP65 · Cable entry 2 × (M20 × 1.5)

Version	Slow-action contacts	DT	Complete units	<input type="checkbox"/>	PU (UNIT, SET, M)	PS*	PG	Weight per PU approx.
			Order No.	List Price \$ per PU				kg

#### Plastic enclosures with integrated hinge



3SE2 283

**With mounted hinges**  
(delivered with additional hinge and fixing accessories)

- Aluminum hinge

Operating angle	Contacts	DT	Order No.	PU (UNIT, SET, M)	PS*	PG	Weight per PU approx.
- Operating angle 4°	1 NO + 2 NC	⊕ A	<b>3SE2 283-0GA43</b>	1	1 unit	102	0.425
- Operating angle 4°	3 NC	⊕ A	<b>3SE2 283-6GA43</b>	1	1 unit	102	0.425
- Operating angle 8°	1 NO + 2 NC	⊕ D	<b>3SE2 283-0GA53</b>	1	1 unit	102	0.420
- Operating angle 8°	3 NC	⊕ C	<b>3SE2 283-6GA53</b>	1	1 unit	102	0.420

- High-grade steel hinge

Operating angle	Contacts	DT	Order No.	PU (UNIT, SET, M)	PS*	PG	Weight per PU approx.
- Operating angle 4°	1 NO + 2 NC	⊕ A	<b>3SE2 283-0GA44</b>	1	1 unit	102	0.800
- Operating angle 4°	3 NC	⊕ C	<b>3SE2 283-6GA44</b>	1	1 unit	102	0.800

⊕ Positive opening according to IEC 60947-5-1, Appendix K.

#### Accessories/spare parts

Version	DT	Order No.	List Price \$ per PU	PU (UNIT, SET, M)	PS*	PG	Weight per PU approx.
							kg

#### Accessories



3SX3 225

**Additional hinges**  
(delivered with fixing accessories)

- Made of aluminum
- Made of high-grade steel

DT	Order No.	PU (UNIT, SET, M)	PS*	PG	Weight per PU approx.
⊕ D	<b>3SX3 225</b>	1	1 unit	102	0.160
⊕ D	<b>3SX3 231</b>	1	1 unit	102	0.330

For 1/2" NPT adaptors and cable glands, see page 13/48.



### Configuration

#### Contact blocks and operating travel of actuators

Contact blocks	Nominal travel	Contact blocks	Nominal travel
Terminal designation acc. to EN 50013	 Contact closed Contact open	Terminal designation acc. to EN 50013	
Hinge switches		Snap-action contacts	
<b>1 NO + 1 NC</b>  Ident. No. 11	<b>3SE5 ...-0HU2.</b>  NSCO_00918 13-14 21-22 **	<b>1 NO + 2 NC</b>  Ident. No. 12	<b>3SE5 ..-0LU2.</b>  NSCO_00919 13-14 21-22 ** 31-32 **

### Dimensional drawings

**Enclosure width 31 mm with hollow shaft**  
 3SE5 212-0.U21, 3SE5 232-0.U21

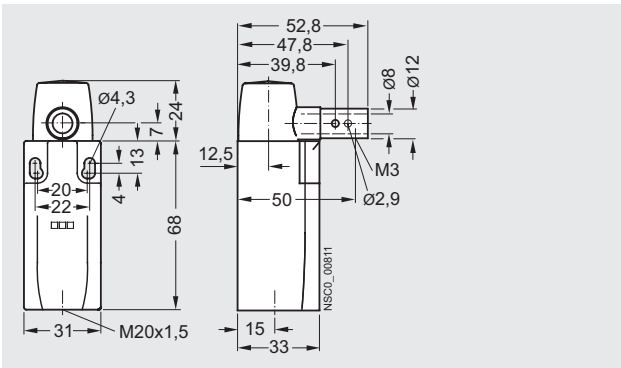

**Enclosure width 31 mm with solid shaft**  
 3SE5 212-0.U22, 3SE5 232-0.U22

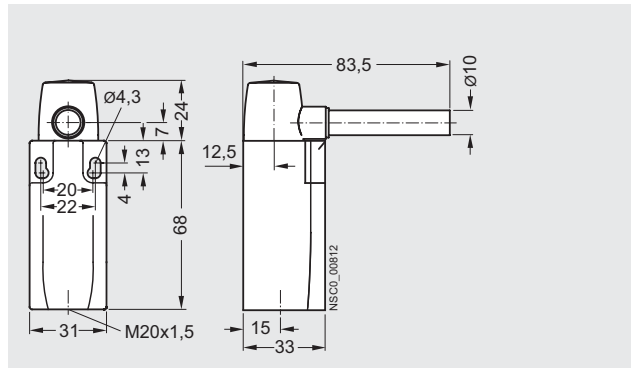

**Enclosure width 40 mm with hollow shaft**  
 3SE5 112-0.U21, 3SE5 132-0.U21

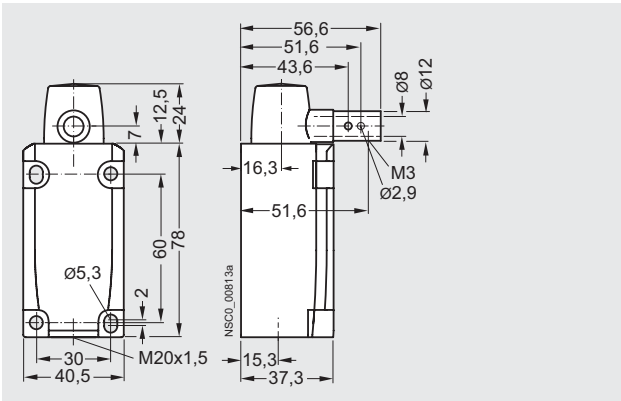

**Enclosure width 40 mm with solid shaft**  
 3SE5 122-0.U22, 3SE5 132-0.U22

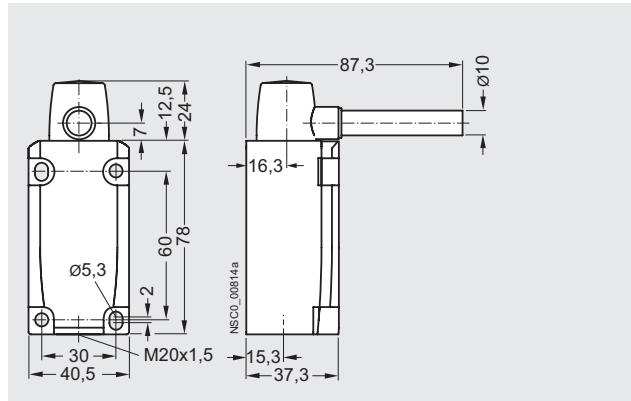

# Mechanical Safety

## 3SE2 Hinge Switches

### 3SE2, plastic enclosures with integrated hinge

#### Overview

The hinge switches are used for monitoring and protecting hinged protective devices such as doors and flaps.

#### Characteristics

- Special design, with 2 × M20 × 1.5 connecting thread
- Degree of protection IP65
- 3 contacts
- Operating angle of 4° or 8°

#### Design

The 3SE2 283 hinge switch has an integrated electromechanical contact block that is actuated when the hinged protective cover is opened. If the cover is opened by 4° or 8°, the NC contact is positively opened by a direct (not spring-action) mechanism. These positively driven contacts guarantee interruption of the electric circuit and stopping of the machine. The NO contact is closed when the cover is moved by 13.5°.

#### Technical specifications

Type	3SE2 283	
Rated insulation voltage $U_i$	V	250
Conventional thermal current $I_{th}$	A	2.5
Rated operational current $I_e$		
• At AC-15, 120 V	A	4.2
• At AC-15, 250 V	A	2
• At DC-13, 24 V	A	1
Min. make-break capacity	> 5 V/1 mA	
Short-circuit protection		
• Operational class gG	A	2
Mechanical endurance	> 1 × 10 <sup>6</sup> operating cycles	
Switching frequency	1200 operating cycles/hour	
Positive opening	2 mm after opening point	
Enclosure material	Plastic	
Degree of protection	IP65	
Ambient temperature	°C	-25 ... +65
Shock resistance	30 g/18 ms	
Resistance to vibrations	20 g/10 ... 200 Hz	
Cable entry	2 × (M20 × 1.5)	
Screw terminals	0.5 ... 1.5 mm <sup>2</sup> /AWG 15	

#### Configuration

##### Contact blocks and operating travel of actuators (operating angle 4°)

Contact blocks	Nominal travel	Contact blocks	Nominal travel
Terminal designation acc. to EN 50013		Terminal designation acc. to EN 50013	
<b>Hinge switches</b>		<b>Slow-action contacts</b>	
<b>1 NO + 2 NC</b>  Ident. No. <b>12</b>	<b>3SE2 283-0GA4.</b>  NSC0_00614a	<b>3 NC</b>  Ident. No. <b>03</b>	<b>3SE2 283-6GA4.</b>  NSC0_00615a

#### Dimensional drawings

3SE2 283-.GA.3 hinge switch with hinge

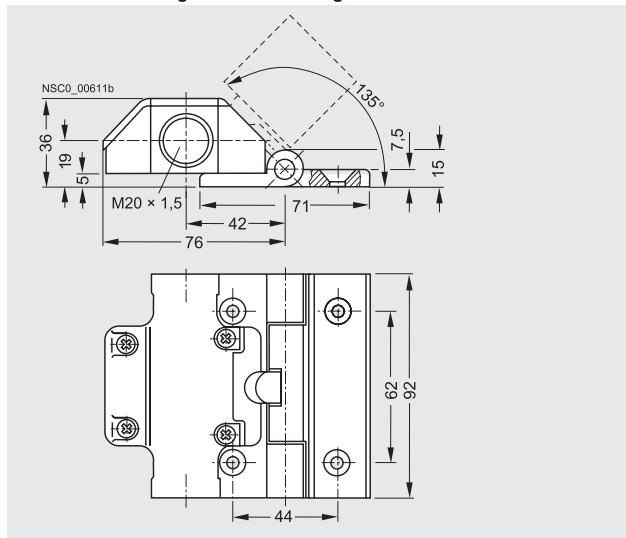

3SX3 225 additional hinge

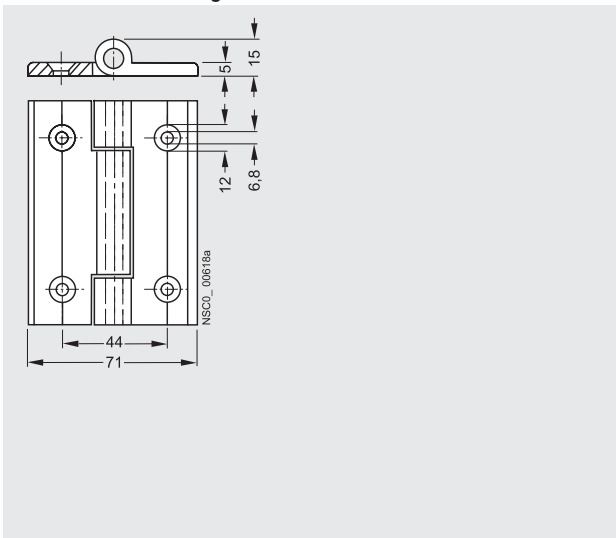

### Overview



Non-contact RFID safety switches with maximum tamper resistance

3SE63 RFID contactless safety switches meet the highest safety requirements, SIL3 or Cat. 4, for monitoring the positions of movable protective devices.

An RFID safety switch consists of a coded RFID switch with an 8-pole M12 connector plug and an identical RFID actuator.

The switch is available in several versions:

- Family coded with M12 plug or with additional 18 N magnetic catch as an option
- Individually coded, programmable once, with M12 plug or with additional 18 N magnetic catch as an option
- Individually coded, programmable more than once (an unlimited number of times), with M12 plug or version with additional 18 N magnetic catch

The actuator is therefore available in two versions:

- Standard
- With 18 N magnetic catch

The magnetic catch keeps doors and hinge switches closed with permanent magnets.

#### Optional accessories

- Covers for sealing mounting holes, also suitable for tamper-proofing screw fixings
- Spacers (approx. 3 mm high) to facilitate cleaning under the installation surface when using pressure washers, for example

#### Mounting and maintenance

Reduction in the number of versions, because

- switches can be mounted on right or left sides
- the actuator can be mounted on all sides

Quick and easy mounting by thanks to universal mounting holes

- Standard gauge/holes for 3SE6 magnetically operated switch
- Fine adjustment thanks to slotted holes

Little adjustment or maintenance required

- Threshold indication by LED on the switch for quick and easy adjustment during installation and maintenance
- Molded switch allows it to be used as an end stop for small and medium-sized doors

#### Note:

Keep metal parts and cuttings away from the vicinity of the switch

Minimum distance between two switches 100 mm

#### Coding

##### Family coded

These safety switches are delivered ready to use, i.e. no programming is necessary.

##### Individually coded, programmable once

The assignment of safety switch and actuator thus created is irreversible.

The actuator is programmed simply by routine during startup, thus permanently preventing any form of tampering by means of a replacement actuator.

##### Individually coded, programmable several times

The procedure for programming a new actuator can be repeated an unlimited number of times. When a new actuator is programmed the previous code becomes invalid. A protected coding process allows new actuators to be programmed for service purposes.

After this, a ten-minute lockout provides enhanced tamper protection. The green LED flashes until the lockout time has ended and the new actuator has been detected. If the operational voltage is interrupted during this time, the ten-minute guard time is restarted.

#### Programming procedure for individual coding

1. Apply operational voltage to safety sensor
2. Move actuator into detecting range: red LED lights up, yellow LED flashes (1 Hz)
3. After 10 s it changes to a shorter flashing frequency (3 Hz). In this state switch off operational voltage.
4. After the next time the operational voltage is switched on, the actuator is detected again to activate the programmed actuator code. The activated code is thus stored permanently.

#### Diagnostics

The RFID safety switch indicates its operating state including faults by means of the LED indicator in the switch and the short-circuit resistant diagnostic output. The signals can then be used for central displays or non-safety-related control tasks.

There are two diagnostics functions:

- Crossover monitoring
- Open-circuit monitoring
- External voltage monitoring
- Ambient temperature too high
- Wrong or defective actuator
- Switching interval threshold identification with LED indication

The signal combination "diagnostics output switched off" and "safety outputs still switched on" can be used to move the machine into a controlled stop position.

Any crossover or a fault that is not currently compromising the safe operation of a safety switch results in the disconnection of the safety channels after a 30 minute delay. However, the diagnostics output switches off instantaneously.

# Mechanical Safety

## SIRIUS 3SE6 RFID Non-Contact Safety Switches

### General data

#### Mode of operation of the diagnostics LEDs

The safety switch indicates not only its operating state, but also faults by means of LEDs in three colors at the ends of the RFID switch.

- The green LED indicates readiness for operation when the control supply voltage is connected.
- The yellow LED indicates that there is an actuator in detecting range. If the actuator is in the switching interval threshold, this is indicated by flashing. This flashing can be used to identify a change in the distance between sensor and actuator at an early stage (e.g. as a result of the sagging of a protective door). The installation should be tested before the distance increases further, the safety outputs switch off and the machine stops.
- The red LED indicates the individual causes of the fault by means of defined flashing frequencies.

### Benefits

- Maximum tamper resistance by means of individual coding of switches and actuators at the highest safety level
- Plastic enclosure with integrated connector
- 2 electronic short-circuit proof safety outputs, each 250 mA
- Integrated crossover, open circuit and external voltage monitoring, with series circuit as far as the control cabinet
- Safety and diagnostics signals can be connected in series
- Series connection of safety circuits in Cat. 4 / PL e / SIL 3
- LED status indication including switching interval threshold indication for quick and easy adjustment during installation and maintenance
- Short-circuit proof conventional diagnostics output
- Optional version with magnetic catch for interlocking hatches or small doors even when de-energized

- Highly rugged thanks to the use of tested enclosure materials, resistant to aggressive cleaning products, with a degree of protection of up to IP69K
- Fine adjustment thanks to slotted holes
- Little adjustment or maintenance required
- Molded switch allows it to be used as an end stop for small and medium-sized doors

### Application

RFID contactless safety switches are designed for use in safety circuits, and are used to monitor the positions of movable protective devices. They monitor the positions of rotating, laterally sliding or removable protective devices using the coded electronic actuator.

Their high degree of protection (IP69K) and the use of cleaning product-resistant materials means that these switches are optimized for use under extreme environmental conditions.

Their electronic operating principle makes these switches ideal for metalworking machinery.

The switches have a larger switching interval and switching displacement than mechanical switches, improve the mounting tolerance of the protective door, and offer a wide range of diagnostics options.

The RFID switches can be connected to all standard evaluation units, e.g. a PLC, 3TK28 safety evaluation units (in which the built-in crossover monitoring function can be deactivated), or the 3RK3 modular safety system.

The following safety categories can be achieved in safety circuits:

- Category 4 according to EN ISO 13849-1 (EN 954-1)
- PL e according to EN ISO 13849-1
- SIL 3 according to IEC 61508

### Technical specifications

Type	3SE6 3	
<b>General data</b>		
Standards	IEC 60947-5-3, IEC 61508, EN ISO 13849-1	
Enclosure material	Fiber-glass strengthened thermoplast, self-extinguishing	
Degree of protection	IP69K	
Ambient temperature		
• During operation	°C	-25 ... +70
• During storage, transport	°C	-25 ... +85
Shock resistance	30 g/11 ms	
Vibration resistance	10 ... 55 Hz amplitude 1 mm	
<b>Electrical specifications</b>		
Rated insulation voltage $U_i$	V	32
Pollution degree acc. to IEC 60664-1		3
Rated impulse withstand voltage $U_{imp}$	V	800
Rated conditional short-circuit current	A	100
Rated operational voltage $U_e$ (PELV acc. to IEC 60204-1)	V DC	24 – 15/+10 %
Protection class	II	
Overvoltage category	III	
Rated operational current $I_e$	A	0.6
Smallest operational current $I_m$	mA	0.5
No-load supply current $I_0$	mA	35

Type	3SE6 3	
<b>Inputs/outputs</b>		
<b>Safety inputs X1/X2</b>		
• Input voltage	V DC	24 – 15/+10 %
• Power consumption per input	mA	5
<b>Safety outputs OSSD1/OSSD2</b>		
		p operation
• Max. rated operational current $I_e$	A	0.25
• Rated operational current $I_e/DC-12/DC-13$ at $U_e$	A	0.25
• Voltage drop $U_e$	V	< 1
• Switching frequency	Hz	1
• Response time, max.	ms	100
• Risk time, max.	ms	200
• Recovery, max.	s	5
<b>Diagnostics output</b>		
		p operation
• Max. rated operational current $I_{e2\max}$	A	0.05
• Rated operational current $I_e/DC-12/DC-13$ at $U_e$	A	0.05
• Voltage drop $U_e$	V	< 2
• Operational current	mA	150
• Conductor capacity, max.	nF	50

# Mechanical Safety

## SIRIUS 3SE6 RFID Non-Contact Safety Switches

### Technical data

1  
2  
3  
4  
5  
6  
7  
8  
9  
10  
11  
12  
13

#### Directions of approach and switching interval

The side area permits a maximum height offset of the switch and actuator of  $\pm 8$  mm (e.g. mounting tolerance or due to sagging of the protective door). The transverse offset also equals max.  $\pm 8$  mm.

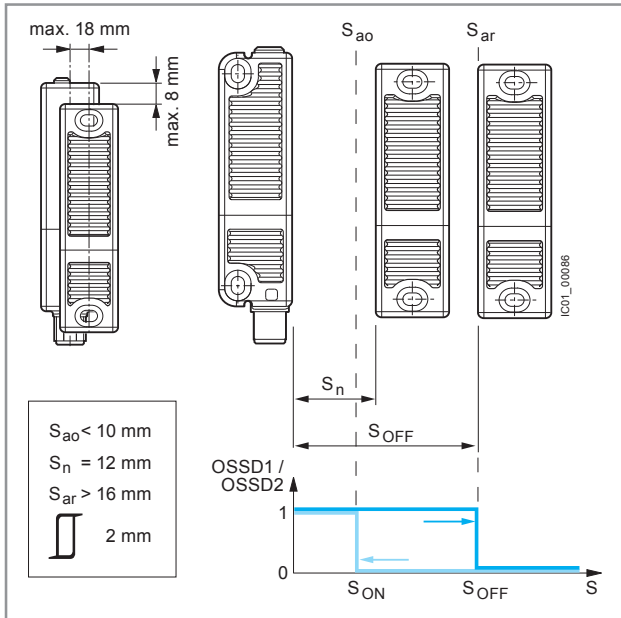

Switching interval: output signal with hysteresis

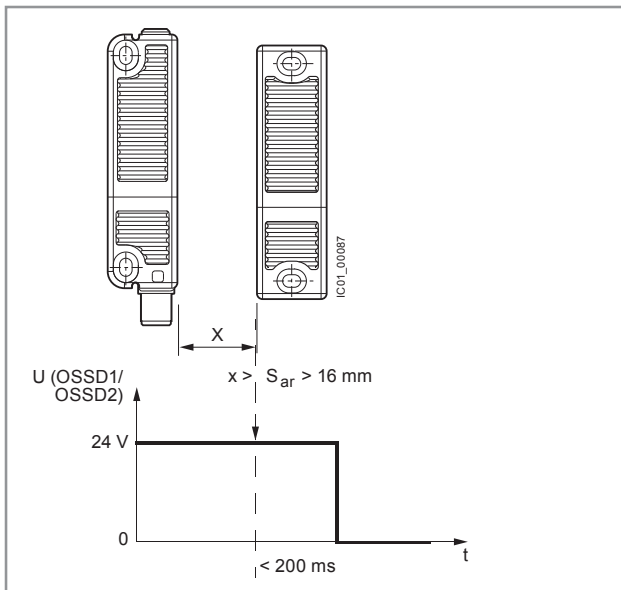

Switching interval: Output signal

#### Connector assignment

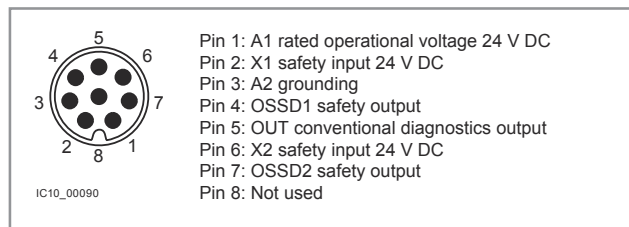

#### Dimensional drawings

##### RFID switches 3SE6 315

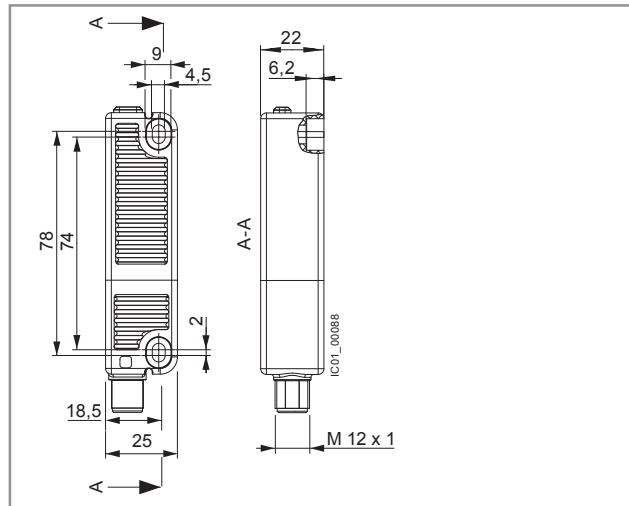

##### RFID actuator 3SE6 310

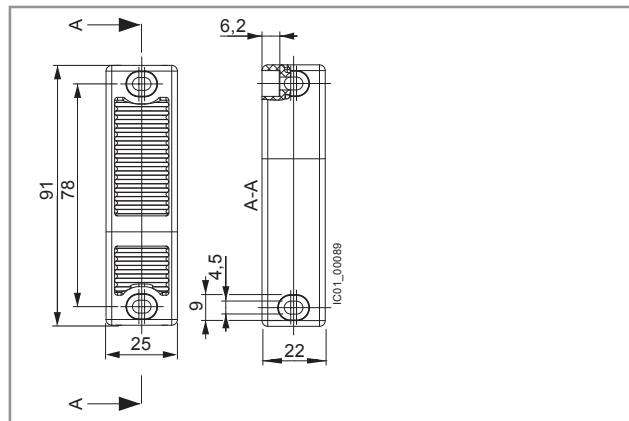





# Mechanical Safety

## SIRIUS 3SE6 RFID Non-Contact Safety Switches

### Selection

#### Selection and ordering data

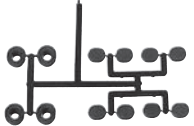
With M12 connector, 8-pole

Version/coding	Latching / length	DT	Order No.	Price per PU	PU (UNIT, SET, M)	PS*
<b>Rectangular safety switches 91 mm x 25 mm</b>						
<b>RFID safety switches</b>						
 3SE6 315	• Family coded	None	▶ <b>3SE6 315-0BB01</b>		1	1 unit
		With 18 N magnetic catch	▶ <b>3SE6 315-1BB01</b>		1	1 unit
	• Individually coded, programmable several times	None	▶ <b>3SE6 315-0BB02</b>		1	1 unit
		With 18 N magnetic catch	▶ <b>3SE6 315-1BB02</b>		1	1 unit
	• Individually coded, programmable once	None	▶ <b>3SE6 315-0BB03</b>		1	1 unit
		With 18 N magnetic catch	▶ <b>3SE6 315-1BB03</b>		1	1 unit
<b>RFID actuators</b>						
 3SE6 310	• Standard	None	▶ <b>3SE6 310-0BC01</b>		1	1 unit
		With 18 N magnetic catch	▶ <b>3SE6 310-1BC01</b>		1	1 unit
<b>Optional accessories</b>						
 3SX5 600-1G	<b>Covers and spacers</b>		A <b>3SX5 600-1G</b>		1	1 unit
	One pack (1 unit) contains 8 covers and 4 spacers					
 3SX5 601-2GA	<b>Connecting cables, 8-pole, with 1 straight M12 socket</b>	Length 3 m	A <b>3SX5 601-2GA03</b>		1	1 unit
		Length 5 m	A <b>3SX5 601-2GA05</b>		1	1 unit
		Length 10 m	A <b>3SX5 601-2GA10</b>		1	1 unit
Rated voltage 30 V						
Rated current 2 A						

For monitoring units see Chapter 14, "Industrial Communication"

### Overview



Switching magnets and contact blocks

A magnetically operated switch is comprised of a coded switching magnet and a contact block (sensor unit). Evaluation requires a safety relay or connection to a bus system.

### 3SE6 806 safety relays

Up to six protective devices (sensors) can be connected to the safety relay.

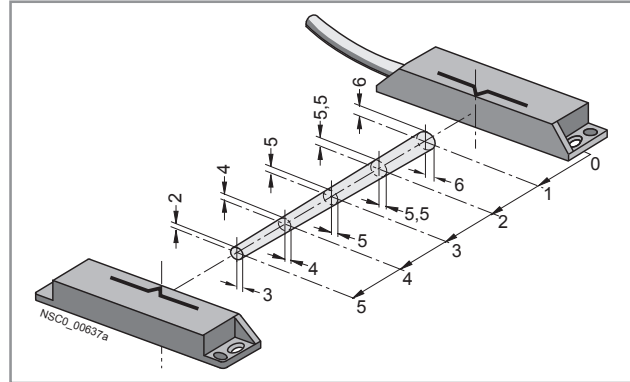

Enabling range (example)

The device has six current-sourcing semiconductor outputs (Y1 ... Y6) which signal the state of the connected protective devices.

The 3SE6 806 safety relay has two floating enabling circuits (safe circuits) as NO contact circuits and one floating signaling circuit as a NC circuit. The number of enabling circuits can be increased by adding one or more 3TK28 30 expansion modules.

### Application

SIRIUS 3SE6 magnetically operated switches are designed for mounting on movable protective guards (hoods, hinge switches, doors, etc.). Evaluation can be performed by means of a safety relay or through connection to a bus system.

The 3SE6 6 non-contact, magnetically operated safety switches stand out due to their enclosed design with degree of protection IP67. They are particularly suitable therefore for areas exposed to contamination, cleaning or disinfecting.

A magnetic monitoring system comprises one or more magnetically operated switches and an evaluation unit, e.g. a safety relay. When contact blocks 1 NO + 1 NC are used the 3SE6 806 safety relay provides a high degree of protection against manipulation and can be installed in safety circuits up to Category 3 according to ISO 13849-1 (EN 954-1).

### Combination of monitoring units and magnetically operated switches

Monitoring units	Magnetically operated switches (contact block + switching magnet)					Achievable category (EN 954-1)/ Performance level (EN ISO 13849-1)		
	1 NO + 1 NC	2 NC	1 NO + 2 NC	3SE6 605-1BA	3SE6 605-2BA		3SE6 605-3BA	3SE6 604-2BA
<b>Relay outputs</b>								
SIRIUS safety relays, 6-fold	3SE6 806-2CD00					Cat. 3		
SIRIUS safety relays	3TK28 20				✓	Cat. 4/e		
	3TK28 26	✓	✓	✓	✓	Cat. 4/e		
<b>Solid-state outputs</b>								
SIRIUS safety relays	3TK28 40				✓	Cat. 3/d		
	3TK28 41, 3TK28 42, 3TK28 45				✓	Cat. 4/e		
SIRIUS safety relays with contactor relay	3TK28 50, 3TK28 51, 3TK28 52				✓	Cat. 3/d		
	3TK28 53				✓	Cat. 4/e		
ASIsafe compact safety modules	3RK1 205, 3RK1 405				✓	Cat. 4		
SIMATIC S7-31xF-2 DP or SIMATIC ET 200M	SM 326 F, 24 DI, 24 V DC, SM 326 F, 8 DI, NAMUR	✓	✓	✓	✓	Cat. 4		
SIMATIC ET 200S PROFIsafe	4/8 F-DI / 3 F-DO, 24 V DC	✓	✓	✓	✓	Cat. 3		
	4/8 F DI, 24 V DC	✓	✓	✓	✓	Cat. 4		
SIMATIC ET 200eco	4/8 F DI, 24 V DC	✓	✓	✓	✓	Cat. 4		
SIMATIC ET 200pro	8/16 F-DI, 24 V DC, 4/8 F-DI / 4 F-DO 2 A, 24 V DC, F-Switch	✓	✓	✓	✓	Cat. 4		
Modular Safety System	3RK3	✓	✓	✓	✓	Cat. 4/e		







✓ Suitable magnetically operated switch

# Mechanical Safety

## 3SE6 Magnetic Monitoring Systems

### Selection

#### Selection and ordering data

Design		Size	S <sub>an</sub> ... S <sub>ab</sub>	Contacts	DT	Order No.	List Price \$	Weight approx.
		mm	mm				1 unit	kg
<b>Round sensor unit. IP67</b>								
3SE6 704-1BA	3SE6 605-1BA	Switching magnet (coded)	M 30			<b>3SE6 704-1BA</b>		0.035
		Switch block with 3 m cable	M 30	5 to 15	1 NO + 1 NC	<b>3SE6 605-1BA</b>		0.166
		Switch block with M12, 4-pole male receptacle <sup>1)</sup>	M 30	5 to 15	1 NO + 1 NC	<b>3SE6 605-1BA02</b>		0.130
<b>Rectangular sensor unit. IP67</b>								
3SE6 605-2BA, 3SE6 704-2BA	3SE6 605-3BA, 3SE6 704-3BA	Switching magnet (coded)	25 × 88			<b>3SE6 704-2BA</b>		0.027
		Switch block with 1 m cable	25 × 88	5 to 15	1 NO + 1 NC 2 NC	<b>3SE6 605-2BA</b> <b>3SE6 604-2BA</b>		0.165 0.165
		Switch block with M8 male receptacle	25 × 88	5 to 15	1 NO + 1 NC 2 NC	<b>3SE6 605-2BA01</b> <b>3SE6 604-2BA01</b>		0.040 0.130
		Switching magnet (coded)	25 × 33			<b>3SE6 704-3BA</b>		0.014
		Switch block with 3 m cable	25 × 33	4 to 14	1 NO + 1 NC	<b>3SE6 605-3BA</b>		0.151
		Switch block with 3 m cable	25 × 33	4 to 14	1 NO + 2 NC	<b>3SE6 606-3BA</b>		0.151
<b>Accessories</b>								
3SX3 260	3SX3 261	Spacer for rectangular sensor unit	25 × 88			<b>3SX3 260</b>		0.015
		Spacer for rectangular sensor unit	25 × 33			<b>3SX3 261</b>		0.010
<b>Monitoring units</b>								
3SE6 806-2CD00		Rated control supply voltage	Width	Enable circuits/signal. circuits	Max. number of connectable sensors	Order No.	List Price \$	Weight approx.
		DC V	mm				1 unit	kg
		24		2 NO / 1 NC	6 1 NO + 1 NC	<b>3SE6 806-2CD00</b>		0.200

1) Pin 1 (S21) + Pin 2 (S22) = Normally Closed; Pin 3 (S13) + Pin 4 (S14) = Normally Open  
Typical 4-pole Female Plugs with black 5 meter cable include: 3RX1542 (right-angle) or 3RX1513 (straight plug).



#### Technical specifications

##### Magnet Switches

Type	3SE6 60.-1BA 3SE6 60.-2BA	3SE6 60.-3BA
<b>Form</b>	M30, 25 mm x 88 mm	25 mm x 33 mm
<b>Standards</b>	DIN EN 50947-5-3 <sup>3)</sup>	
<b>Sensing type</b>	Magnetic	
<b>Rated voltage</b>	AC/DC 100 V, 120 V	DC 24 V
<b>Rated current</b>	400 mA	100 mA
<b>Performance</b>	10 VA/W	1 W
<b>Max. switching frequency</b>	5 Hz	
<b>Max. sensing distance <math>S_{an} \dots S_{ab}</math></b>	5 ... 15 mm	4 ... 14 mm
<b>Housing material</b>	Fiber-glass strengthened with glass fiber	
<b>Degree of protection</b> acc. to IEC 60529	IP67	
<b>Permissible ambient temperature</b>	<ul style="list-style-type: none"> <li>• Operating: -25 to +70 °C</li> <li>• Storage: -25 to +70 °C</li> </ul>	
<b>Shock resistance</b>	10 g/11ms	
<b>Vibration resistance</b>	10 ... 55 Hz, 1 mm amplitude	
<b>Conductor</b>	Cable LiYY 4 x 0.25 mm <sup>2</sup> 3 m length	
<b>Receptacle, male</b>	M12, M8	-
<b>Cable length</b> (max for connecting to monitoring unit)	1000 m	100 m

##### Magnet Switch Monitoring Unit

Type	3SE6 806-2CD00
<b>Standards</b>	EN ISO 13849-1, EN 1088
<b>Rated control supply voltage <math>U_c</math></b>	DC 24 V
<b>Rated control supply voltage tolerance</b>	0.85 ... 1.2 x $U_s$
<b>Rated power</b> (without signal outputs Y1 ... Y6)	3 W
<b>Maximum load current</b>	<ul style="list-style-type: none"> <li>• Signaling circuit Y1 ... Y6: 20 mA</li> <li>• Signaling circuit 31, 32: 2 A</li> </ul>
<b>Inputs</b>	6 sensors (1 NO or 1 NC)
<b>Outputs</b>	6 signaling outputs 1 relay output 2 enabling circuits
<b>Response time</b>	<ul style="list-style-type: none"> <li>• Automatic start: 150 ms typical</li> <li>• Manual start: 25 ms typical</li> </ul>
<b>Release time</b>	20 ms max.
<b>Recovery time</b>	350 ms
<b>Degree of protection to IEC 60529</b>	IP20
<b>Switching capacity<sup>1)</sup></b>	Release circuits (13, 14 and 23, 24) Continuous current, $I_{th}$ : 6 A Rated operational current, $I_e$ <sup>2)</sup> : <ul style="list-style-type: none"> <li>• AC-15 @ 203 V: 6 A</li> <li>• DC-13:               <ul style="list-style-type: none"> <li>- 24 V: 6 A</li> <li>- 115 V: 0.2 A</li> <li>- 230 V: 0.1 A</li> </ul> </li> </ul>
<b>Short circuit protection</b>	DIAZED <ul style="list-style-type: none"> <li>• Fuse type: DIAZED</li> <li>• Duty class:               <ul style="list-style-type: none"> <li>- gL(gC): 6 A</li> <li>- Quick response: 10 A</li> </ul> </li> </ul>
<b>Permissible ambient temperature, <math>T_u</math></b>	<ul style="list-style-type: none"> <li>• Operating: -25 to +45 °C</li> <li>• Storage: -25 to +70 °C</li> </ul>

1) Utilization category per DIN VDE 0660, Part 200, IEC 60947-5-1  
2) With all release circuits loaded

3) In combination with monitoring unit or AS-Interface.

# Mechanical Safety

## 3SE6 Magnetic Monitoring Systems

### Dimensional drawings

#### Dimension drawings

##### Round sensor units

Switch block 3SE6 605-1BA

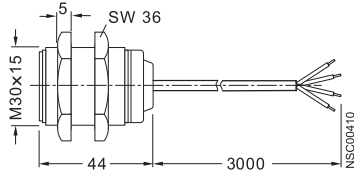

Switch block 3SE6 605-1BA02

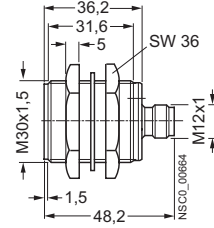

Coded switching magnet 3SE6 704-1BA

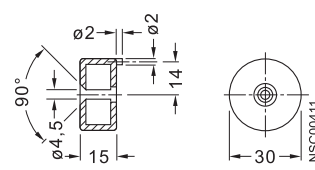

##### Rectangular sensor units

Switch block 3SE6 605-2BA

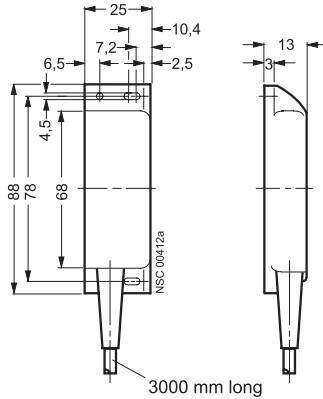

Switching magnet without lead

Switch block 3SE6 60.-2BA0.

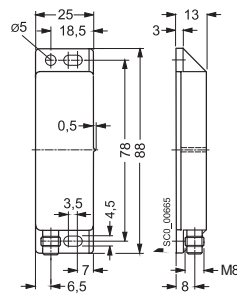

Switch block 3SE7 704-2BA

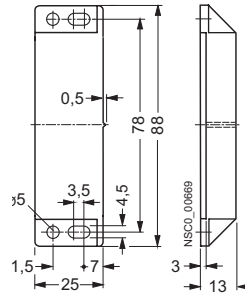

3SX3 260 spacer

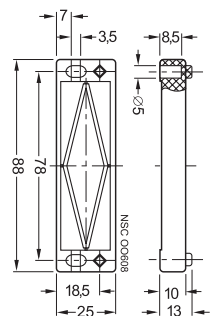

Switch block 3SE6 605-3BA

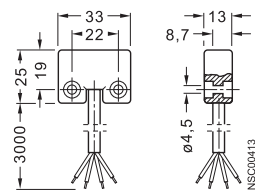

Coded switching magnet 3SE6 704-3BA

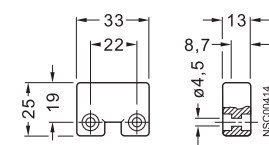

3SX3 261 spacer

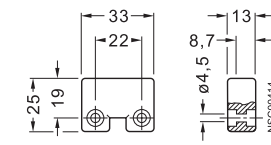

##### Monitoring unit

Magnet Switch Monitor 3SE6 806-2CD00

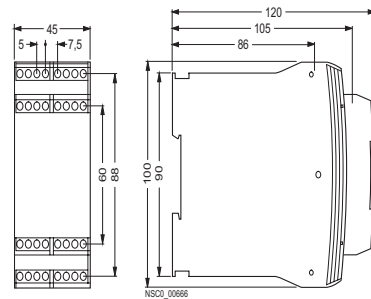

### Circuit diagrams

#### Connection example

#### Single Channel Control, Manual Start, Category 3 to EN ISO 13849-1

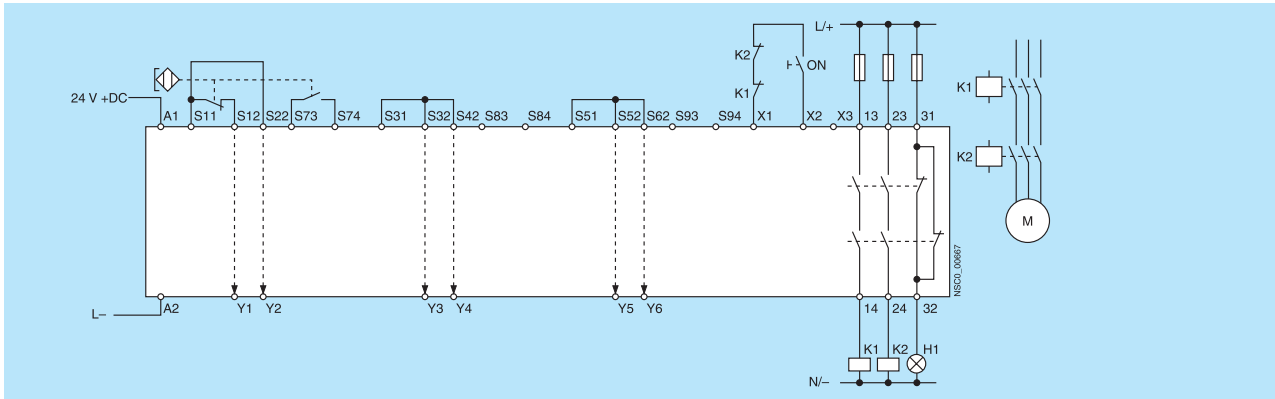

#### Six Channel Control. Automatic Start, Category 3 to EN ISO 13849-1

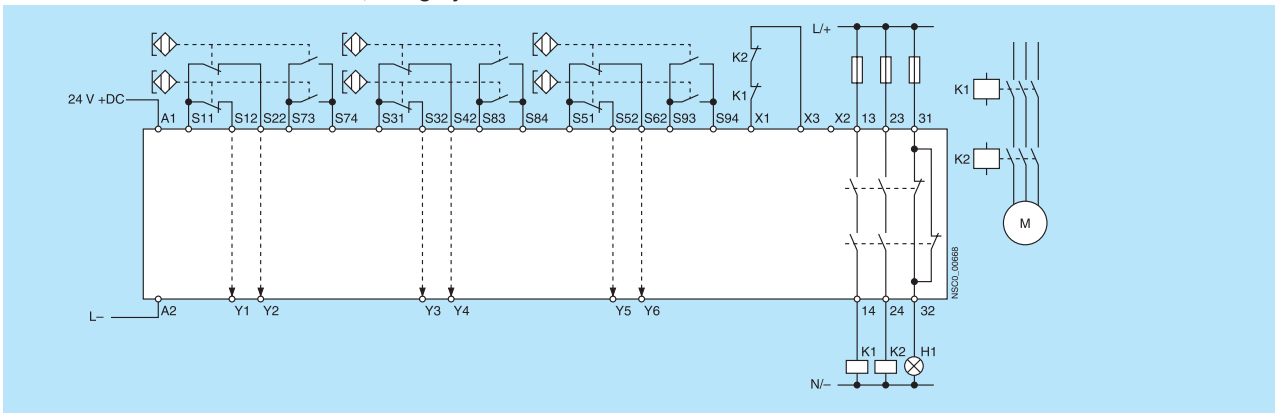

### Terminal Assignments

Power	A1+, L+	U <sub>s</sub>
	A2-, L-	24 V DC
Sensors	S11, S12	Channel 1, NC contact
	S11, S22	Channel 2, NC contact
	S31, S32	Channel 3, NC contact
	S31, S42	Channel 4, NC contact
	S51, S52	Channel 5, NC contact
	S51, S62	Channel 6, NC contact

Sensors (Cont.)	S73, S74	Channel 1+2, NO contact (parallel)
	S83, S84	Channel 3+4, NO contact (parallel)
	S93, S94	Channel 5+6, NO contact (parallel)
Outputs	13, 14	Release circuit 1 (safety NO contact)
	23, 24	Release circuit 2 (safety NO contact)
	31, 32	Floating signaling circuit
	Y1 to Y6	Status of Channels 1 through 6

#### 3SE6 604-2BA magnetically operated switch with 3TK28 safety relay, Category 4 to EN ISO 13849-1

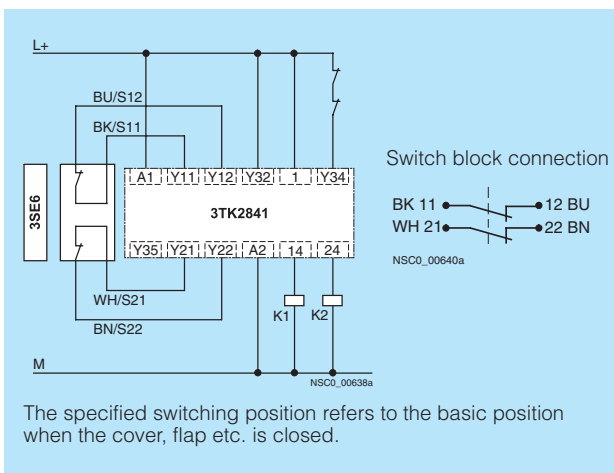

#### 3SE6 604-2BA magnetically operated switch on AS-Interface Safety at Work, safe K45F or K60F compact module, Category 4 to EN ISO 13849-1

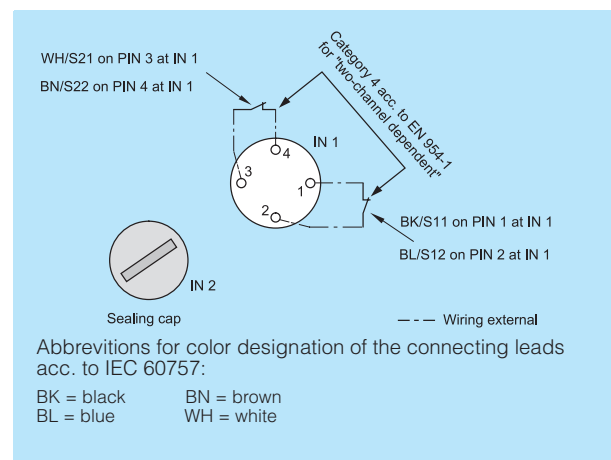

# Mechanical Safety

## 3SB3 Two-Hand Control

### Selection

#### Application

Two-hand operation consoles are required for use with machines and systems that have hazardous areas, in order to direct both hands of the operator to one position.

Operation consoles are primarily used on presses, stamping machines, printing presses and paper converting machines, in the chemical industry and in the rubber and plastics industries.

#### Specifications

Two-hand operation consoles fulfill the requirements laid down in DIN 24 980 and EN 574.

#### Construction

##### Equipment

All consoles are pre-equipped with SIGNUM 3SB3 control devices. The metal version is also available as an unequipped empty enclosure.

The plastic version can be retrofitted with up to 8 command points, in line with the customer's requirements. The surface of the console has premachined breaking points for this purpose.

##### Installation



The two-hand operation consoles can be mounted either on the stand available or directly on the machine by means of the holes in the rear panel.

#### Principle of operation

The control command is given by pressing the two operating elements simultaneously (within

0.5 s of each other) and must be maintained for as long as a hazard exists.

#### Selection and ordering data

Design	DT	Order No.	List Price \$ 1 unit	Weight approx. kg
3SB38 63-4BB 	<b>SIGUARD two-hand operation console</b>			
	Degree of protection IP 65, acc. to DIN 24 980 (EN 574), Standard equipment with 2 black operating elements (mushroom button 3SB30 00-1GA11, Ø 40 mm, 1 NO + 1 NC) and a red EMERGENCY-STOP mushroom button 3SB30 00-1HA20, latching Ø 40 mm, 2 NC			
	<ul style="list-style-type: none"> <li>• <b>Metal version</b> <ul style="list-style-type: none"> <li>- with standard equipment</li> <li>- with standard equipment and 4 additional holes for control devices 22.5 mm</li> <li>- empty enclosure, unequipped</li> </ul> </li> </ul>			
	<ul style="list-style-type: none"> <li>• <b>Plastic version</b> <ul style="list-style-type: none"> <li>- with standard equipment and predetermined breaking points for 8 further command points 22.5 mm</li> <li>- with cable inlet holes for metric screwed cable glands</li> </ul> </li> </ul>			
		<b>3SB38 63-4BB</b>		4.800
		<b>3SB38 63-4BA</b>		4.800
		<b>3SB38 63-4BC</b>		4.800
		<b>3SB38 63-1BB3</b>		2.300
3SB39 01-0AQ 	<b>Stand for SIGUARD two-hand operation consoles</b>			
	<ul style="list-style-type: none"> <li>• with cable inlet holes for metric screwed cable glands</li> </ul>			
		<b>3SB39 01-0AQ3</b>		4.500

#### Dimension drawings

3SB38 63-4 operator panel with metal enclosure

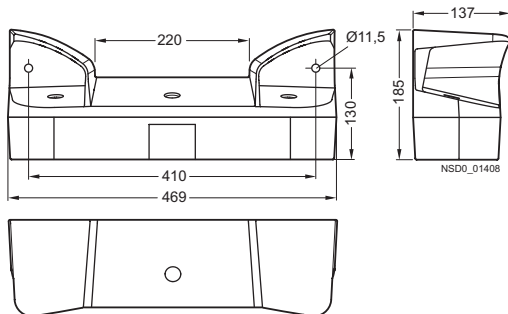

3SB39 01-0AQ stand

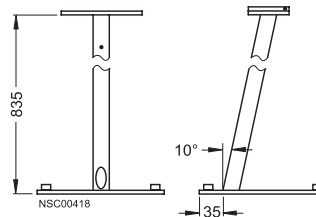

Note:

Also available with AS-Interface connection, contact your local Siemens representative.

### Overview



SIRIUS 3SK1 safety relays

SIRIUS 3SK1 safety relays are the key components of a consistent, cost-effective safety chain. Whether you need EMERGENCY-STOP, protective door monitoring, light arrays, laser scanners or the protection of presses or punches – with the 22.5 mm wide SIRIUS safety relays every safety application can be implemented to optimum effect in terms of engineering and price.

The following safety-oriented functions are available:

- Monitoring the safety functions of sensors
- Monitoring the sensor leads
- Monitoring correct functioning of safety relays
- Monitoring the actuators in the shutdown circuit
- Safety-oriented disconnection when dangers arise

SIRIUS 3SK1 safety relays satisfy the most stringent requirements of IEC 61508/IEC 62061 (SIL 3) and EN ISO 13849-1 (PL e).

SIRIUS 3SK1 safety relays stand out due to their flexibility in both parameterization and system configurations with several evaluation units. Optimized solutions when selecting components are facilitated by a clearly structured component range:

- Standard basic units
- Advanced basic units
- Output expansions
- Input expansions
- Accessories

The 3SK1 Standard basic units are characterized by the following features:

- Compact design
- Simple operation
- Relay and semiconductor outputs
- Economical solution

However, the 3SK1 Advanced basic units also offer the following:

- Universal application options thanks to multi-functionality
- Time-delayed outputs
- Expansion of inputs and outputs

In the case of Advanced basic units, the 3ZY1 device connector allows safety functions involving several sensors and actuators to be constructed very quickly.

The 3SK1 Standard and Advanced series are a high-quality replacement for the 3TK28 safety relays. In their slimmer design, and equipped with greater functionality, they can replace every 3TK28 device. The only exceptions are devices with special functions, such as 3TK28 26, 3TK28 45 and the 3TK28 10 devices. For a code conversion table from 3TK28 to 3SK1 [see page 13/127](#)

# Safety Relays

## SIRIUS 3SK1

### General Data

#### Function overview of the 3SK1 series

Type	Standard basic units		Advanced basic units	
	Relay enabling circuits	Solid-state enabling circuits	Relay enabling circuits	Solid-state enabling circuits
<b>Sensors</b>				
• Mechanical	✓	✓	✓	✓
• Non-floating	✓	✓	✓	✓
• Antivalent	--	--	✓	✓
• Expandable	--	✓ by means of cascading	✓	✓
<b>Parameters</b>				
• Start (auto/monitored)	✓	✓	✓	✓
• Sensor connection 2 x 1-channel/ 1 x 2-channel	--	✓	✓	✓
• Cross-circuit detection	✓ by means of wiring	✓	✓	✓
• Start-up test ON/OFF	--	✓	✓	✓
• Monitoring of two-hand operation consoles	--	--	✓	✓
<b>Enabling circuits</b>				
• Instantaneous	✓	✓	✓	✓
• Delayed	--	--	✓	✓
• Expandable with relay enabling circuits	✓ by means of wiring	✓ by means of wiring	✓	✓
• Device connectors	--	--	✓	✓
<b>Rated control supply voltage</b>				
• 24 V DC	✓	✓	✓ <sup>1)</sup>	✓ <sup>1)</sup>
• 115 ... 240 V AC/DC	✓	--	✓ <sup>1)</sup>	✓ <sup>1)</sup>
✓ Available -- Not available				

<sup>1)</sup> Possible using 3SK1 230 power supply via device connector.

#### Order No. scheme

Digit of the Order No.	1st - 3rd	4th	5th	6th	7th	8th	9th	10th	11th	12th	
Safety relays	3SK										
Generation	□										
Device version	□										
Device series	□										
Type of outputs	□										
Connection type	□										
Rated control supply voltage	□										
Type of rated control supply voltage	□										
Time delay	□										
Example	3SK	1	1	2	1	-	1	A	B	4	0

Note:

The Order No. scheme is presented here merely for information purposes and for better understanding of the logic behind the order numbers.

For your orders, please use the order numbers quoted in the catalog in the selection and ordering data.

#### 3SK1 12 and 3SK1 112 safety relays with DIP switch

The 3SK1 12 and 3SK1 112 safety relays are configurable safety relays. They are used as evaluation units for the typical safety chain (detecting, evaluating, disconnecting). DIP switches on the front can be used to set many different functions. Thus the 3SK1 12 and 3SK1 112 can be used universally.

OFF	Diagram	DIP switch No.	ON
Autostart sensor input		1	Monitored start sensor input
Without cross-circuit detection		2	With cross-circuit detection
2 x single-channel sensor connection		3	1 x two-channel sensor connection
With start-up test		4	Without start-up test

#### Number of safe outputs

	Relay enabling circuits		Solid-state enabling circuits		3ZY1 device connectors
	Instantaneous	Delayed	Instantaneous	Delayed	
<b>3SK1 Standard basic units</b>					
3SK1 111	3	--	--	--	--
3SK1 112	--	--	2	--	--
<b>3SK1 Advanced basic units</b>					
3SK1 120	--	--	1	--	✓
3SK1 121-.AB40	3	--	--	--	✓
3SK1 121-.CB4.	2	2	--	--	✓
3SK1 122-.AB40	--	--	3	--	✓
3SK1 122-.CB4.	--	--	2	2	✓
<b>3SK1 expansion units</b>					
3SK1 211	4	--	--	--	✓
3SK1 213	3	--	--	--	✓
✓ Available -- Not available					

## Benefits

### General

- Suitable for all safety applications because of its compliance with the highest safety requirements (SIL 3 PL e)
- Universal use thanks to adjustable parameters
- Worldwide use thanks to globally valid certificates
- Compact SIRIUS design
- Device connectors with standard rail mounting for flexible interconnectability and expandability
- Removable terminals for greater plant availability
- Yellow terminal covers clearly identify the device as a safety component.
- Sensor cable up to 2 000 m long allows it to be used in large-scale plants.

### Relay outputs

- Different voltages can be switched through the floating contacts
- Higher currents can be switched with relay contacts

### Solid-state outputs

- Wear-free
- Suitable for operation in fast switching applications
- Insensitive to vibrations and dirt
- Good electrical endurance

### Power outputs (3SK1 213 output expansion)

- Different voltages can be switched through the floating contacts
- The power relay contacts allow currents of up to 10 A AC-15/DC-13 to be connected
- High mechanical and electrical endurance
- Protective separation between enabling circuits and between enabling circuits and electronics

### 3ZY1 device connectors

Using 3ZY1 device connectors to combine devices reduces the time required to configure and wire the components. At the same time errors are avoided during wiring, and this considerably reduces the testing required for the fully-configured application.

### Microprocessor systems

- Flexible use thanks to many different integrated functions
- Easy parameterization using DIP switches on the front
- High functional reliability based on extensive monitoring functions
- Operated by the machine control system
- Also connection of non-contact sensors (light arrays, light barriers etc.)

### Configuration and stock keeping

Variable setting options by means of DIP switches, a wide voltage range and a special power supply unit reduce the cost of keeping stocks and the considerations involved in configuration where the evaluation units to be selected are concerned.

### Spring-type terminal with push-in functionality

Push-in connections are a form of spring-type terminals allowing fast wiring without tools for rigid conductors or conductors equipped with end sleeves.

As with other spring-type terminals, a screwdriver (with 3.0 mm x 0.5 mm blade) is required to disconnect the conductor. The same tool can also be used to wire finely-stranded or stranded conductors with no end finishing.

The advantages of the push-in terminals are found, as with all spring-type terminals, in speed of assembly and disassembly and vibration-proof connection. There is no need for the checking and tightening required with screw terminals.

# Safety Relays

## SIRIUS 3SK1

### Standard basic units

#### Overview



3SK1 11 Standard basic units

The 3SK1 11 Standard basic units are characterized by simple, variable functionality. These devices are recommended for safety functions requiring only a few sensors and a small number of outputs on the safety relay.

#### Selection and ordering data



PU (UNIT, SET, M) = 1  
PS\* = 1 unit



3SK1 111-1AB30



3SK1 112-1BB40

Rated control supply voltage $U_s$		DT	<b>Screw terminals</b> 	DT	<b>Spring-type terminals (push-in)</b> 	
At 60 Hz At AC V	At DC V		Order No.	Price per PU	Order No.	Price per PU
<b>Standard basic units with 3 relay enabling circuits</b>						
24	24	A	<b>3SK1 111-1AB30</b>	A	<b>3SK1 111-2AB30</b>	
110 ... 240	110 ... 240	A	<b>3SK1 111-1AW20</b>	A	<b>3SK1 111-2AW20</b>	
<b>Standard basic units with 2 safety-oriented semiconductor outputs</b>						
--	24	A	<b>3SK1 112-1BB40</b>	A	<b>3SK1 112-2BB40</b>	



### Overview



3SK1 12 Advanced basic units

The 3SK1 12 Advanced basic units form an innovative system landscape which allows even complex safety functions with large numbers of sensors and outputs to be configured using the device connectors. It is possible to increase both the number of inputs for sensors and the number of enabling circuits of the basic unit without the need for wiring between the devices.

### Selection and ordering data

PU (UNIT, SET, M) = 1  
PS\* = 1 unit



3SK1 121-1AB40



3SK1 122-1AB40



3SK1 122-1CB41

Rated control supply voltage $U_s$ at DC	Adjustable off-delay time	Number of outputs		Semiconductor outputs		DT	Screw terminals		DT	Spring-type terminals (push-in)	
		Relay contacts		Instantaneous	Delayed		Instantaneous	Delayed		Order No.	Price per PU
V	s	Instantaneous	Delayed	Instantaneous	Delayed						
<b>Advanced basic units with relay outputs</b>											
24	--	3	--	--	--	A	<b>3SK1 121-1AB40</b>	A	<b>3SK1 121-2AB40</b>		
24	0.05 ... 3	2	2	--	--	A	<b>3SK1 121-1CB41</b>	B	<b>3SK1 121-2CB41</b>		
24	0.5 ... 30	2	2	--	--	A	<b>3SK1 121-1CB42</b>	A	<b>3SK1 121-2CB42</b>		
24	5 ... 300	2	2	--	--	B	<b>3SK1 121-1CB44</b>	B	<b>3SK1 121-2CB44</b>		
<b>Advanced basic units with semiconductor outputs</b>											
24	--	--	--	1	--	A	<b>3SK1 120-1AB40</b>	A	<b>3SK1 120-2AB40</b>		
24	--	--	--	3	--	A	<b>3SK1 122-1AB40</b>	A	<b>3SK1 122-2AB40</b>		
24	0.05 ... 3	--	--	2	2	B	<b>3SK1 122-1CB41</b>	B	<b>3SK1 122-2CB41</b>		
24	0.5 ... 30	--	--	2	2	A	<b>3SK1 122-1CB42</b>	A	<b>3SK1 122-2CB42</b>		
24	5 ... 300	--	--	2	2	B	<b>3SK1 122-1CB44</b>	B	<b>3SK1 122-2CB44</b>		

# Safety Relays

## SIRIUS 3SK1

### Output expansion units

#### Overview



3SK1 21 output expansion

The 3SK1 21 output expansions can be used for Standard and Advanced basic units.

#### 3SK1 211 output expansion

The 3SK1 211 output expansion is used to expand the enabling circuits of a basic unit by adding another four enabling circuits. These enabling circuits have a switching capacity of AC-15 4 A at a switching voltage of 230 V. The devices can be connected to any 3SK1 basic unit by means of wiring. In addition the devices with a 24 V DC control supply voltage can also be connected to 3SK1 Advanced basic units by means of the 3ZY1 2 device connector.

#### 3SK1 213 output expansion

The 3SK1 213 output expansion is used to expand the enabling circuits of a basic unit by adding three enabling circuits with high switching capacity. These enabling circuits have a switching capacity of AC-15 10 A at a switching voltage of 230 V. The devices can be connected to any 3SK1 basic unit by means of wiring. As with 3SK1 211, it is also possible to use the version with a control supply voltage of 24 V DC on the 3ZY1 2 device connector.

#### Note:

It is only possible to expand the Standard basic units by means of wiring. Advanced basic units can be expanded using the 3ZY1 2 device connector.

#### Benefits

- Perfect adaptation of the number of outputs
- Simple expansion of instantaneous and time-delayed outputs of Advanced basic units by means of device connector and slide switch on expansion module
- Expansion with power contacts for high AC-15/DC-13 currents in the control circuit
- No enabling circuit required in the evaluation unit to control the expansion modules
- No wiring of the feedback circuit to the expansion units
- Shorter installation times
- Less configuring and testing required

#### Selection and ordering data



PU (UNIT, SET, M) = 1  
PS\* = 1 unit



3SK1 211-1BB00



3SK1 213-1AB40

Rated control supply voltage $U_s$		Number of outputs, switching instantaneously	Rated operational current <sup>1)</sup>		Suitability for use of 3ZY1 2 device connector	DT	Screw terminals 		DT	Spring-type terminals (push-in) 	
At 60 Hz At AC	at DC		AC	DC			Order No.	Price per PU		Order No.	Price per PU
V	V		A	A							
<b>4RO output expansions</b>											
24	--	4	B300	R300	--	B	<b>3SK1 211-1BB00</b>	A		<b>3SK1 211-2BB00</b>	
--	24	4	B300	R300	✓	A	<b>3SK1 211-1BB40</b>	A		<b>3SK1 211-2BB40</b>	
110 ... 240	110 ... 240	4	B300	R300	--	A	<b>3SK1 211-1BW20</b>	B		<b>3SK1 211-2BW20</b>	
<b>3RO output expansions</b>											
--	24	3	A300	P300	✓	A	<b>3SK1 213-1AB40</b>	A		<b>3SK1 213-2AB40</b>	
115	--	3	A300	P300	--	B	<b>3SK1 213-1AJ20</b>	B		<b>3SK1 213-2AJ20</b>	
230	--	3	A300	P300	--	B	<b>3SK1 213-1AL20</b>	B		<b>3SK1 213-2AL20</b>	

- ✓ Available  
-- Not available

<sup>1)</sup> For a detailed description of the NEMA Control Circuit Rating see page 19/7

#### Overview



3SK1 220 sensor expansion

With the input expansions

- 3SK1 220 sensor expansion
- 3SK1 230 power supply

the Advanced basic units can be made more flexible.

#### 3SK1 220 input expansion

The 3SK1 220 input expansion allows additional sensors to be integrated easily and flexibly. The device monitors two 1-channel sensors or one 2-channel sensor, whatever their output technology (floating/single-ended).

#### 3SK1 230 power supply

The 3SK1 230 power supply makes the 3SK1 devices universally usable, whatever control supply voltage is to be used.

Both devices can be combined with the 3SK1 12 basic units in the Advanced series without the need for wiring.

#### Note:

The 3SK1 220 sensor expansion can only be connected to the Advanced basic units by means of the 3ZY1 2 device connector.

Alongside the 3ZY1 2 device connector, the 3SK1 230 power supply can also be wired to act as a power supply for 3SK1 devices.

#### Benefits

- A wide voltage range of 110 ... 240 V AC/DC allows the devices to be used worldwide
- Low stock keeping due to low variance
- Flexible expansion of the number of sensors without the need for additional wiring between the devices
- Perfect adaptation of the number of inputs to suit the application
- Universally usable thanks to the wide range of adjustable parameters for sensor expansion (parameters as for Advanced basic units)

#### Selection and ordering data



PU (UNIT, SET, M) = 1  
PS\* = 1 unit



3SK1 220-1AB40



3SK1 230-1AW20

Version	DT	Screw terminals 	DT	Spring-type terminals (push-in) 	
		Order No.	Price per PU	Order No.	Price per PU
<b>3SK1 220 input expansions</b>					
<b>Sensor expansions</b>					
For safety-oriented expansion of the Advanced basic units by adding a further two-channel sensor or two single-channel sensors					
Note:					
Can only be used in conjunction with 3ZY1 2 device connectors, see page 13/124.					
	A	<b>3SK1 220-1AB40</b>	A	<b>3SK1 220-2AB40</b>	
<b>3SK1 230 power supplies</b>					
<b>Power supplies</b>					
For supplying Advanced basic units via 3ZY1 2 device connectors at voltages of 110 ... 240 V AC/DC					
	A	<b>3SK1 230-1AW20</b>	A	<b>3SK1 230-2AW20</b>	

# Safety Relays

## SIRIUS 3SK1

### Accessories

#### Overview

The following accessories are available for SIRIUS 3SK1 safety relays:

- Device connectors
- Terminals
- Sealable covers
- Push-in lugs
- Adapters
- Connection cables
- Inscription labels
- Tools

#### Device connectors for 3SK1 12. and 3SK1 2..

The device connector allows several safety relays to be interconnected. The last device in a row is placed on a device termination connector. This closes the circuits that were configured with the connectors.

Device connectors are available in various versions specifically for the 3SK1 safety relays:

For type	Device connectors		Device termination connectors	
	3ZY1 212-1BA00 (type 1, width 17.5 mm)	3ZY1 212-2BA00 (type 1, width 22.5 mm)	3ZY1 212-2DA00 (type 1, width 22.5 mm)	3ZY1 212-0FA01 (type 2, set for enclosure 45 mm)

#### 3SK1 Advanced basic units

3SK1 120	✓	--	--	--
3SK1 121	--	✓	✓	--
3SK1 122	--	✓	✓	--

#### Output expansions

3SK1 211	--	✓	✓	--
3SK1 213	--	--	--	✓

#### Input expansions

3SK1 220	✓	--	--	--
3SK1 230	--	✓	--	--

✓ Available

-- Not available

#### Selection and ordering data

Version	DT	Order No.	Price per PU	PU (UNIT, SET, M)	PS*
---------	----	-----------	--------------	-------------------	-----

#### Device connectors for the electrical connection of SIRIUS devices in the industrial enclosure for fixing on TH 35 standard mounting rail



3ZY1 212-1BA00

##### Device connectors

- Type 1, 7-pole, 17.5 mm wide
- Type 1, 7-pole, 22.5 mm wide
- No function, width 22.5 mm

A	3ZY1 212-1BA00	1	1 unit
A	3ZY1 212-2BA00	1	1 unit
X	3ZY1 210-2AA00	1	1 unit



3ZY1 212-2DA00

##### Device termination connectors

- Type 1, 7-pole, 22.5 mm wide
- Type 2, 7-pole, 22.5 mm wide

A	3ZY1 212-2DA00	1	1 unit
▶	3ZY1 212-2FA00	1	1 unit

##### Device termination connector set

Type 2, 7-pole, width > 45 mm, comprising 3ZY1 212-2FA00 and 3ZY1 210-2AA00

A	3ZY1 212-0FA01	1	1 unit
---	----------------	---	--------

#### Terminals for SIRIUS devices in the industrial enclosure for fixing on TH 35 standard mounting rail



3ZY1 121-1BA00

##### Removable terminals

- 2-pole, screw terminals up to 2 x 1.5 mm<sup>2</sup> or 1 x 2.5 mm<sup>2</sup>
- 2-pole, screw terminals up to max. 2 x 2.5 mm<sup>2</sup> or 1 x 4 mm<sup>2</sup>
- 3-pole, screw terminals up to max. 2 x 1.5 mm<sup>2</sup> or 1 x 2.5 mm<sup>2</sup>
- 2-pole, push-in terminals up to max. 2 x 1.5 mm<sup>2</sup>
- 2-pole, push-in terminals up to max. 2 x 2.5 mm<sup>2</sup> or 1 x 4 mm<sup>2</sup>
- 3-pole, push-in terminals up to max. 2 x 1.5 mm<sup>2</sup>

A	3ZY1 121-1BA00	1	6 units
▶	3ZY1 122-1BA00	1	6 units
▶	3ZY1 131-1BA00	1	6 units
▶	3ZY1 121-2BA00	1	6 units
▶	3ZY1 122-2BA00	1	6 units
▶	3ZY1 131-2BA00	1	6 units

Version	DT	Order No.	Price per PU	PU (UNIT, SET, M)	PS*
---------	----	-----------	--------------	-------------------	-----

#### Enclosure accessories



3ZY1 321-2AA00

##### Sealable covers

- 17.5 mm (for 3SK1 120 and 3SK1 220)
- 22.5 mm (for all 3SK1 devices other than 3SK1 120 and 3SK1 220)

▶	<b>3ZY1 321-1AA00</b>	1	5 units
▶	<b>3ZY1 321-2AA00</b>	1	5 units



3ZY 1311-0AA00

##### Push-in lugs for wall mounting

▶	<b>3ZY1 311-0AA00</b>	1	10 units
---	-----------------------	---	----------

#### Adapters and connection cables



3TK28 10-1A

##### Adapters for connecting encoders of type Siemens/Heidenhain

- 15-pole

A	<b>3TK28 10-1A</b>	1	1 unit
---	--------------------	---	--------



3TK28 10-1B

- 25-pole

A	<b>3TK28 10-1B</b>	1	1 unit
---	--------------------	---	--------



3TK28 10-0A

##### Connection cables for connecting the safety relay to the 3TK28 10-1A or 3TK28 10-1B adapter

for connecting the safety relay to the 3TK28 10-1A or 3TK28 10-1B adapter

C	<b>3TK28 10-0A</b>	1	1 unit
---	--------------------	---	--------

#### Blank inscription labels

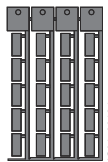

3RT29 00-1SB20

##### Unit labeling plates for SIRIUS devices

20 mm x 7 mm, titanium gray

D	<b>3RT29 00-1SB20</b>	100	340 units
---	-----------------------	-----	-----------

#### Tools for opening spring-type terminals



3RA29 08-1A

##### Screwdrivers for all SIRIUS devices with spring-type terminals;

3.0 mm x 0.5 mm; length approx. 200 mm; titanium gray/black, partially insulated

##### Spring-type terminals



▶	<b>3RA29 08-1A</b>	1	1 unit
---	--------------------	---	--------

# Safety Relays

## SIRIUS 3SK1

### Technical Data

#### Application

SIRIUS 3SK1 safety relays are used mainly in autonomous safety applications which are not connected to a safety-oriented bus system. Their function here is to evaluate the sensors and the safety-oriented shutdown of hazards. Also they check and monitor the sensors, actuators and safety-oriented functions of the safety relay.

#### Technical specifications

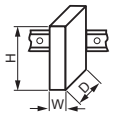
Type		3SK1 safety relays	
Dimensions		mm	22.5
• Width		mm	100
• Height		mm	120
• Depth			
General technical specifications			
<b>Ambient temperature</b>			
• During operation	°C	-25 ... +60	
• During storage	°C	-40 ... +80	
<b>Installation altitude above sea level, maximum</b>		m	2 000
<b>Air pressure</b> according to SN 31205		hPa	900 ... 1 060
<b>Shock resistance</b>			8 g / 11 ms
<b>Vibration resistance</b> according to IEC 60068-2-6			5 ... 500 Hz: 0.75 mm
<b>IP degree of protection of the enclosure</b>			IP20
<b>Touch protection against electric shock</b>			Finger-safe
<b>Rated insulation voltage</b>		V	300
<b>Rated impulse withstand voltage</b>		V	4 000
<b>Safety integrity level (SIL) for time-delayed enabling circuit</b> according to IEC 61508			SIL 3
<b>Performance level (PL) for time-delayed enabling circuit</b> according to ISO 13849-1			e
<b>Electromagnetic compatibility (EMC)</b> EMC emitted interference Certificate of suitability			IEC 60947-5-1, class B Available soon

#### Code conversion table

The table below lists the existing 3TK28 order numbers with the corresponding 3SK1 order numbers.

Order number 3TK28 basic units	Order number 3SK1 Standard basic units	Order number 3SK1 Advanced basic units
<b>3TK28 20</b>		
3TK28 20-1AJ20	3SK1 111-1AW20	3SK1 121-1AB40 + 3SK1 230-1AW20
3TK28 20-1AL20	3SK1 111-1AW20	3SK1 121-1AB40 + 3SK1 230-1AW20
3TK28 20-1CB30	3SK1 111-1AB30	3SK1 121-1AB40
3TK28 20-2AJ20	3SK1 111-2AW20	3SK1 121-2AB40 + 3SK1 230-2AW20
3TK28 20-2AL20	3SK1 111-2AW20	3SK1 121-2AB40 + 3SK1 230-2AW20
3TK28 20-2CB30	3SK1 111-2AB30	3SK1 121-2AB40
<b>3TK28 21</b>		
3TK28 21-1CB30	3SK1 111-1AB30	3SK1 121-1AB40
3TK28 21-2CB30	3SK1 111-2AB30	3SK1 121-2AB40
<b>3TK28 22</b>		
3TK28 22-1CB30	3SK1 111-1AB30	3SK1 121-1AB40
3TK28 22-2CB30	3SK1 111-2AB30	3SK1 121-2AB40
<b>3TK28 23</b>		
3TK28 23-1CB30	3SK1 111-1AB30	3SK1 121-1AB40
3TK28 23-2CB30	3SK1 111-2AB30	3SK1 121-2AB40
<b>3TK28 24</b>		
3TK28 24-1AJ20	3SK1 111-1AW20	3SK1 121-1AB40 + 3SK1 230-1AW20
3TK28 24-1AL20	3SK1 111-1AW20	3SK1 121-1AB40 + 3SK1 230-1AW20
3TK28 24-1BB40	3SK1 111-1AB30	3SK1 121-1AB40
3TK28 24-1CB30	3SK1 111-1AB30	3SK1 121-1AB40
3TK28 24-2AJ20	3SK1 111-2AW20	3SK1 121-2AB40 + 3SK1 230-2AW20
3TK28 24-2AL20	3SK1 111-2AW20	3SK1 121-2AB40 + 3SK1 230-2AW20
3TK28 24-2BB40	3SK1 111-2AB30	3SK1 121-2AB40
3TK28 24-2CB30	3SK1 111-2AB30	3SK1 121-2AB40
<b>3TK28 25</b>		
3TK28 25-1AB20	3SK1 111-1AW20	3SK1 121-1AB40 + 3SK1 230-1AW20
3TK28 25-1AJ20	3SK1 111-1AW20	3SK1 121-1AB40 + 3SK1 230-1AW20
3TK28 25-1AL20	3SK1 111-1AW20	3SK1 121-1AB40 + 3SK1 230-1AW20
3TK28 25-1BB40	3SK1 111-1AB30	3SK1 121-1AB40
3TK28 25-2AB20	3SK1 111-2AW20	3SK1 121-2AB40 + 3SK1 230-2AW20
3TK28 25-2AJ20	3SK1 111-2AW20	3SK1 121-2AB40 + 3SK1 230-2AW20
3TK28 25-2AL20	3SK1 111-2AW20	3SK1 121-2AB40 + 3SK1 230-2AW20
3TK28 25-2BB40	3SK1 111-2AB30	3SK1 121-2AB40
<b>3TK28 27</b>		
3TK28 27-1AB20	--	--
3TK28 27-1AB21	--	--
3TK28 27-1AJ20	--	3SK1 121-1CB42 + 3SK1 230-1AW20
3TK28 27-1AJ21	--	3SK1 121-1CB41 + 3SK1 230-1AW20
3TK28 27-1AL20	--	3SK1 121-1CB42 + 3SK1 230-1AW20
3TK28 27-1AL21	--	3SK1 121-1CB41 + 3SK1 230-1AW20
3TK28 27-1BB40	--	3SK1 121-1CB42
3TK28 27-1BB41	--	3SK1 121-1CB41
3TK28 27-2AB20	--	--
3TK28 27-2AB21	--	--
3TK28 27-2AJ20	--	3SK1 121-2CB42 + 3SK1 230-2AW20
3TK28 27-2AJ21	--	3SK1 121-2CB41 + 3SK1 230-2AW20
3TK28 27-2AL20	--	3SK1 121-2CB42 + 3SK1 230-2AW20
3TK28 27-2AL21	--	3SK1 121-2CB41 + 3SK1 230-2AW20
3TK28 27-2BB40	--	3SK1 121-2CB42
3TK28 27-2BB41	--	3SK1 121-2CB41

Order number 3TK28 basic units	Order number 3SK1 Standard basic units	Order number 3SK1 Advanced basic units
<b>3TK28 28</b>		
3TK28 28-1AB20	--	--
3TK28 28-1AB21	--	--
3TK28 28-1AJ20	--	3SK1 121-1CB42 + 3SK1 230-1AW20
3TK28 28-1AJ21	--	3SK1 121-1CB41 + 3SK1 230-1AW20
3TK28 28-1AL20	--	3SK1 121-1CB42 + 3SK1 230-1AW20
3TK28 28-1AL21	--	3SK1 121-1CB41 + 3SK1 230-1AW20
3TK28 28-1BB40	--	3SK1 121-1CB42
3TK28 28-1BB41	--	3SK1 121-1CB41
3TK28 28-2AB20	--	--
3TK28 28-2AB21	--	--
3TK28 28-2AJ20	--	3SK1 121-2CB42 + 3SK1 230-2AW20
3TK28 28-2AJ21	--	3SK1 121-2CB41 + 3SK1 230-2AW20
3TK28 28-2AL20	--	3SK1 121-2CB42 + 3SK1 230-2AW20
3TK28 28-2AL21	--	3SK1 121-2CB41 + 3SK1 230-2AW20
3TK28 28-2BB40	--	3SK1 121-2CB42
<b>3TK28 30</b>		
3TK28 30-1AJ20	3SK1 211-1BW20	3SK1 211-1BB40
3TK28 30-1AL20	3SK1 211-1BW20	3SK1 211-1BB40
3TK28 30-1CB30	3SK1 211-1BB40	3SK1 211-1BB40
3TK28 30-2AJ20	3SK1 211-2BW20	3SK1 211-2BB40
3TK28 30-2AL20	3SK1 211-2BW20	3SK1 211-2BB40
3TK28 30-2CB30	3SK1 211-2BB40	3SK1 211-2BB40
<b>3TK28 34</b>		
3TK28 34-1AB20	--	--
3TK28 34-1AJ20	--	3SK1 121-1AB40 + 3SK1 230-1AW20
3TK28 34-1AL20	--	3SK1 121-1AB40 + 3SK1 230-1AW20
3TK28 34-1BB40	--	3SK1 121-1AB40
3TK28 34-2AB20	--	--
3TK28 34-2AJ20	--	3SK1 121-2AB40 + 3SK1 230-2AW20
3TK28 34-2AL20	--	3SK1 121-2AB40 + 3SK1 230-2AW20
3TK28 34-2BB40	--	3SK1 121-2AB40
<b>3TK28 40</b>		
3TK28 40-1BB40	3SK1 112-1BB40	3SK1 122-1AB40
3TK28 40-2BB40	3SK1 112-2BB40	3SK1 122-2AB40
<b>3TK28 41</b>		
3TK28 41-1BB40	3SK1 112-1BB40	3SK1 122-1AB40
3TK28 41-2BB40	3SK1 112-2BB40	3SK1 122-2AB40
<b>3TK28 42</b>		
3TK28 42-1BB41	--	3SK1 122-1CB41
3TK28 42-1BB42	--	3SK1 122-1CB42
3TK28 42-1BB44	--	3SK1 122-1CB44
3TK28 42-2BB41	--	3SK1 122-2CB41
3TK28 42-2BB42	--	3SK1 122-2CB42
3TK28 42-2BB44	--	3SK1 122-2CB44
<b>3TK28 50</b>		
3TK28 50-1AJ20	3SK1 111-1AW20 + 3SK1 213-1AJ20	3SK1 120-1AB40 + 3SK1 213-1AB40
3TK28 50-1AL20	3SK1 111-1AW20 + 3SK1 213-1AL20	3SK1 120-1AB40 + 3SK1 213-1AB40
3TK28 50-1BB40	3SK1 111-1AB30 + 3SK1 213-1AB40	3SK1 120-1AB40 + 3SK1 213-1AB40
3TK28 50-2AJ20	3SK1 111-2AW20 + 3SK1 213-2AJ20	3SK1 120-2AB40 + 3SK1 213-2AB40
3TK28 50-2AL20	3SK1 111-2AW20 + 3SK1 213-2AL20	3SK1 120-2AB40 + 3SK1 213-2AB40
3TK28 50-2BB40	3SK1 111-2AB30 + 3SK1 213-2AB40	3SK1 120-2AB40 + 3SK1 213-2AB40

# Safety Relays

## SIRIUS 3SK1

### Cross reference

Order number 3TK28 basic units	Order number 3SK1 Standard basic units	Order number 3SK1 Advanced basic units
<b>3TK28 51</b>		
3TK28 51-1AJ20	3SK1 111-1AW20 + 3SK1 213-1AJ20	3SK1 120-1AB40 + 3SK1 213-1AB40
3TK28 51-1AL20	3SK1 111-1AW20 + 3SK1 213-1AL20	3SK1 120-1AB40 + 3SK1 213-1AB40
3TK28 51-1BB40	3SK1 111-1AB30 + 3SK1 213-1AB40	3SK1 120-1AB40 + 3SK1 213-1AB40
3TK28 51-2AJ20	3SK1 111-2AW20 + 3SK1 213-2AJ20	3SK1 120-2AB40 + 3SK1 213-2AB40
3TK28 51-2AL20	3SK1 111-2AW20 + 3SK1 213-2AL20	3SK1 120-2AB40 + 3SK1 213-2AB40
3TK28 51-2BB40	3SK1 111-2AB30 + 3SK1 213-2AB40	3SK1 120-2AB40 + 3SK1 213-2AB40
<b>3TK28 52</b>		
3TK28 52-1AL20	3SK1 111-1AW20 + 3SK1 213-1AL20	3SK1 120-1AB40 + 3SK1 213-1AB40
3TK28 52-1BB40	3SK1 111-1AB30 + 3SK1 213-1AB40	3SK1 120-1AB40 + 3SK1 213-1AB40
3TK28 52-2AL20	3SK1 111-2AW20 + 3SK1 213-2AL20	3SK1 120-2AB40 + 3SK1 213-2AB40
3TK28 52-2BB40	3SK1 111-2AB30 + 3SK1 213-2AB40	3SK1 120-2AB40 + 3SK1 213-2AB40

Order number 3TK28 basic units	Order number 3SK1 Standard basic units	Order number 3SK1 Advanced basic units
<b>3TK28 53</b>		
3TK28 53-1BB40	3SK1 111-1AB30 + 3SK1 213-1AB40	3SK1 120-1AB40 + 3SK1 213-1AB40
3TK28 53-2BB40	3SK1 111-2AB30 + 3SK1 213-2AB40	3SK1 120-2AB40 + 3SK1 213-2AB40
<b>3TK28 56</b>		
3TK28 56-1BB40	3SK1 213-1AB40	3SK1 213-1AB40
3TK28 56-2BB40	3SK1 213-2AB40	3SK1 213-2AB40
<b>3TK28 57</b>		
3TK28 57-1BB41	--	3SK1 213-1AB40 (delay as for basic unit)
3TK28 57-1BB42	--	3SK1 213-1AB40 (delay as for basic unit)
3TK28 57-1BB44	--	3SK1 213-1AB40 (delay as for basic unit)
3TK28 57-2BB41	--	3SK1 213-2AB40 (delay as for basic unit)
3TK28 57-2BB42	--	3SK1 213-2AB40 (delay as for basic unit)
3TK28 57-2BB44	--	3SK1 213-2AB40 (delay as for basic unit)



## Overview

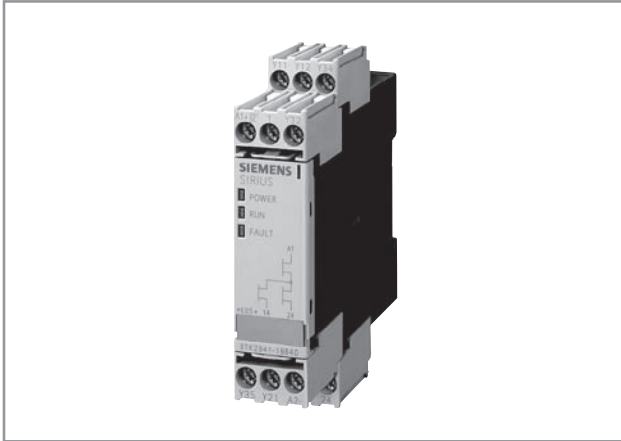

SIRIUS 3TK28 safety relay

SIRIUS safety relays are the key modules of a consistent and cost-effective safety chain. Be it EMERGENCY-STOP disconnection, protective door monitoring or the protection of presses or punches – with SIRIUS safety relays every safety application can be implemented to optimum effect in terms of engineering and price.

SIRIUS safety relays provide numerous safety-related functions:

- Monitoring the safety functions of sensors
- Monitoring the sensor leads
- Monitoring the correct operation of the safety relay
- Monitoring actuators for standstill
- Safety-oriented disconnection when dangers arise

Depending on the version of the device, SIRIUS safety relays satisfy the most stringent requirements (PL e) according to ISO 13849-1 and achieve the highest Safety Integrity Level (SIL 3) acc. to IEC 61508.

### 3TK28 Safety Relays

#### With relay enabling circuits

Basic units

3TK28 26

[See page 13/134](#)

Basic units  $T_v$

3TK28 26

#### With electronic enabling circuits

Multifunction units

3TK28 45

[See page 13/134](#)

#### With special functions

Standstill monitors

3TK28 10-0

[See page 13/134](#)

Overspeed monitors

3TK28 10-1

## Benefits

### General

- Can be used for all safety applications thanks to compliance with the highest safety requirements (PL e according to ISO 13849-1 or SIL 3 according to IEC 61508)
- Suitable for use all over the world through compliance with all globally established certifications
- Compact, service-proven SIRIUS design creates more space in the control cabinet
- Flexible connectability and expandability make subsequent changes easy
- Removable terminal for greater plant availability
- Yellow front plate clearly identifies the device as an item of safety technology
- Sensor cable up to 2000 m long enables use in large-scale plants

### Relay outputs

- Different voltages can be switched through the floating contacts
- Higher currents can be switched with relay contacts

### Solid-state outputs

- Wear-free
- Suitable for operation in fast switching applications
- Insensitive to vibrations and dirt
- Good electrical endurance

### Microprocessor systems

- Flexible use thanks to many different integrated functions
- Easy parameterization using DIP switches on the front
- High functional reliability based on extensive monitoring functions
- Operated by the machine control system
- Also connection of non-contact sensors (light arrays, light barriers etc.)

## Application

SIRIUS safety relays are used mainly in autonomous safety applications which are not connected to a safety-oriented bus system.

Their function here is to evaluate the sensors and the safety-oriented shutdown of hazards. Also they check and monitor the sensors, actuators and safety-oriented functions of the safety relay.

# Safety Relays

## SIRIUS 3TK28

### General data

#### Overview



SIRIUS 3TK28 2. safety relay

#### Safety relays with relay enabling circuits – safety with floating contacts

SIRIUS safety relays with relay enabling circuits not only save a great deal of space thanks to their compact design but also offer extra safety in the form of positively driven pairs of make and break contacts. If one of the contacts becomes welded, the other will disconnect the circuit. A positively driven break contact (NC) then performs the fault detection of the faulty make contact (NO).

#### 3TK28 26 safety relays

The 3TK28 26 is a parameterizable safety relay. It is used as an evaluation unit for typical safety chains (detection, evaluation, disconnection). DIP switches on the front can be used to set many different functions. The 3TK28 26 is therefore universally applicable.

Safety sensors (e.g. EMERGENCY-STOP pushbuttons) are connected at the input side while contactors or valves for disconnecting the "hazardous function" are connected at the output side. The 3TK28 26 performs the monitoring of the sensor and actuator functions as well as the safe disconnection of the outputs (enabling circuits).

3TK28 26 with DIP switch:

OFF	Schematic	DIP switch No.	ON
Without crossover monitoring		1	Switching mat operation
NC/NO evaluation:		2	NC/NC contact evaluation
2 x 1-channel		3	1 x 2-channel
Debounce time for sensor inputs 50 ms		4	Debounce time for sensor inputs 10 ms
Sensor input autostart		5	Sensor input monitored start
Cascading input autostart		6	Cascading input monitored start
With start test		7	Without start test
Automatic start after mains failure (not permitted in connection with a start test)		8	Without automatic start after mains failure

#### Benefits

##### 3TK28 26 safety relays

- Compact design
- Connection of all standard sensor types
- Many functions available in a single unit
- Status indications
- Expanded diagnostics options
- Approvals (EN 13849-1, IEC 61508, UL/CSA)
- Signaling of disconnect faults in the actuator circuit
- Floating outputs
- Units with wide voltage range
- Saving of the sensor status in the event of voltage failure
- Can be used up to an ambient temperature of max. 70 °C

#### Overview

##### 3TK28 45 multi-function units

Evaluation units with solid-state components are being used increasingly in safety applications because their permanent checking of functions and largely wear-free operation results in a far higher switching frequency and electrical endurance of equipment. The compact and lightweight units also permit series connection or normal switching duty, e.g. by a PLC.

Up to now, standard combinations of safety applications such as EMERGENCY-STOP and protective door monitoring were possible only by using several individual safety relays. 3TK28 45 combines several functions in a single unit. Two solid-state and two relay enabling circuits ensure safe disconnection – in just a few actions, quickly and cheaply.

#### Benefits

##### 3TK28 45 safety relays

- 2 sensor inputs (e.g. EMERGENCY-STOP, protective door)
- Also suitable for protective door interlocking and OK buttons
- 2 solid-state enabling circuits and 2 relay enabling circuits
- Permanent function checking
- No wear because switched electronically
- High switching frequency
- Long electrical endurance
- Evaluation of solid-state sensors
- Sensor lead up to max. 2 000 m
- Cascading possible
- Insensitive to vibrations and dirt
- Compact design, low weight

### Overview

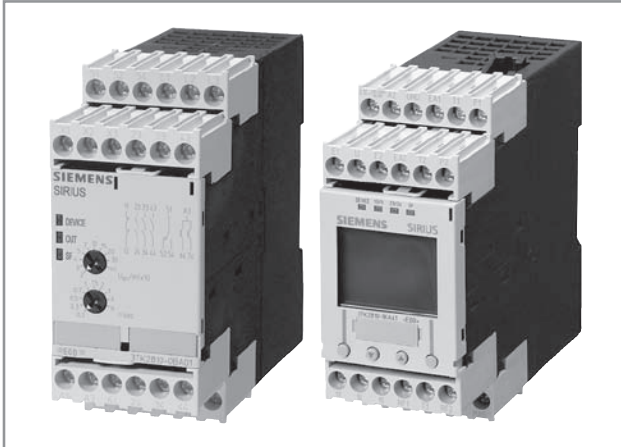

SIRIUS 3TK28 10 safety relays

#### **3TK28 10-0 standstill monitor**

The standstill monitor increases safety in hazardous areas. Without a sensor, it detects motor stoppage from the residual magnetization of the rotating motor. When an adjustable threshold value is undershot, it uses its outputs to allow access to hazardous areas for example by unlocking a protective door.

#### **3TK28 10-1 overspeed monitors**

The overspeed monitor combines two safety functions in one unit by continuously monitoring machines and plants for standstill and speed.

Through simple parameterization and permanent diagnosis on the display, faults can be quickly remedied at any time – often before they cause plant downtimes.

In addition to standstill and speed monitoring the unit also features integrated monitoring of a protective door with spring-type interlocking. An additional evaluation unit is not needed therefore.

### Benefits

#### **3TK28 10-0 standstill monitor**

- No additional sensors required
- Signaling of faults with diagnostics display
- Standstill time can be set
- Unit can be used with frequency converters

#### **3TK28 10-1 overspeed monitors**

- Menu-prompted, easy parameterization
- Direct diagnosis on the display means shorter downtimes thanks to early fault detection
- Integrated protective door monitoring means greater safety because access to the plant is allowed only in the safe state
- Suitable for all standard sensors, i.e. high flexibility

# Safety Relays

## SIRIUS 3TK28

### General data

Type	Basic units				Standstill monitors 3TK28 10-0	Overspeed monitors 3TK28 10-1
	3TK28 26 24 V DC	Wide voltage range	24 V DC $t_V$	Wide voltage range $t_V$		
<b>Sensors</b>						
• Inputs	1	1	1	1	3	4
• Electronic	✓	--	✓	--	--	3
• With contacts	✓	✓	✓	✓	--	1
• Without sensors (measuring inputs)	--	--	--	--	3	--
• Magnetically operated switch (Reed contacts)	✓	✓	✓	✓	--	--
<b>Safety mats</b>	✓	✓	✓	✓	--	--
<b>Start</b>						
• Auto	✓	✓	✓	✓	✓	✓
• Monitored	✓	✓	✓	✓	--	✓
<b>Cascading input 24 V DC</b>	✓	✓	✓	✓	--	--
<b>Key-operated switch</b>	--	--	--	--	--	--
<b>Enabling circuit, floating</b>						
• Stop category 0	4 NO	4 NO	2 NO	2 NO	3 NO + 1 NC	2
• Stop category 1	--	--	2 NO	2 NO	--	--
<b>Enabling circuit, solid-state</b>						
• Stop category 0	--	--	--	--	--	--
• Stop category 1	--	--	--	--	--	--
<b>Signaling outputs</b>						
• Floating	1 NC	1 NO + 1 NC	2 NC	1 NO + 2 NC	1 CO	--
• Electronic	2	--	2	--	2	2
<b>Standards</b>	EN 60204-1, EN ISO 12100, EN 954-1, IEC 61508	EN 60204-1, EN ISO 12100, EN 954-1, IEC 61508	EN 60204-1, EN ISO 12100, EN 954-1, IEC 61508	EN 60204-1, EN ISO 12100, EN 954-1, IEC 61508	EN 60204-1, EN ISO 12100, EN 954-1, IEC 61508	IEC 60947-5-1, EN ISO 13849-1, EN 60204-1, IEC 61508
<b>Compliance to standards</b>	TÜV, UL, CSA	TÜV, UL, CSA	TÜV, UL, CSA	TÜV, UL, CSA	TÜV, UL, CSA	TÜV
<b>Category according to EN 954-1 max</b>	4	4	4	4	4	4
<b>SIL level max. according to IEC 61508</b>	3	3	3	3	3	3
<b>Performance level PL according to ISO 13849-1</b>	e	e	e	e	e	e
<b>Probability of a dangerous failure per hour (PFH<sub>d</sub>)</b>	$7.8 \times 10^{-9}$ 1/h	$7.8 \times 10^{-9}$ 1/h	$7.8 \times 10^{-9}$ 1/h	$7.8 \times 10^{-9}$ 1/h	$1.5 \times 10^{-8}$ 1/h	$3.38 \times 10^{-9}$ 1/h
<b>Rated control supply voltage</b>						
• 24 V DC	✓	--	✓	--	✓	✓
• 24 V AC/DC	--	--	--	--	--	--
• 24 V AC	--	--	--	--	--	--
• 115 V AC	--	--	--	--	--	--
• 230 V AC	--	--	--	--	✓	--
• 400 V AC	--	--	--	--	✓	--
• 24 ... 240 V AC/DC	--	✓	--	✓	--	✓

✓ Available

-- Not available

1) Only possible for instantaneous enabling contacts, otherwise Category 3.

2) For expansion of Siemens safety products.

3) Only possible for instantaneous enabling contacts, otherwise SIL 2 or Performance Level PL d.

1  
2  
3  
4  
5  
6  
7  
8  
9  
10  
11  
12  
13

#### Selection and ordering data

Type	Multi-function units 3TK28 45							
	"Automatic and monitored start"	"Automatic and monitored start" $t_v$	"Monitored start"	"Monitored start" $t_v$	OK button	OK button $t_v$	"Spring-type interlocking" $t_v$	"Magnet-locked interlocking" $t_v$
<b>Sensors</b>								
• Inputs	2	2	2	2	2	2	2	2
• Electronic	✓	✓	✓	✓	✓	✓	✓	✓
• With contacts	✓	✓	✓	✓	✓	✓	✓	✓
• Magnetically operated switch (Reed contacts)	✓	✓	✓	✓	✓	✓	✓	✓
<b>Safety mats</b>	✓	✓	✓	✓	--	--	--	--
<b>Start</b>								
• Auto	1	1	--	--	1	1	--	--
• Monitored	1	1	2	2	1	1	2	2
<b>Cascading input 24 V DC</b>	✓	✓	✓	✓	✓	✓	✓	✓
<b>Key-operated switch</b>	✓	✓	✓	✓	✓	✓	✓	✓
<b>Enabling circuit, floating</b>								
• Stop category 0	2 NO	1 NO	2 NO	1 NO	2 NO	1 NO	1 NO	1 NO
• Stop category 1	--	1 NO	--	1 NO	--	1 NO	1 NO	1 NO
<b>Enabling circuit, solid-state</b>								
• Stop category 0	2	1	2	1	2	1	1	1
• Stop category 1	--	1	--	1	--	1	1	1
<b>Signaling outputs</b>								
• Floating	--	--	--	--	--	--	--	--
• Electronic	1	1	1	1	1	1	1	1
<b>Standards</b>	EN 60204-1, EN ISO 12100, EN 954-1, IEC 61508							
<b>Test certificates</b>								
<b>Category according to EN 954-1 max</b>	4	4	4	4	4	4	4	4
<b>SIL level max. according to IEC 61508</b>	3	3	3	3	3	3	3	3
<b>Performance level PL according to ISO 13849-1</b>	e	e	e	e	e	e	e	e
<b>Probability of a dangerous failure per hour (PFH<sub>d</sub>)</b>	$6.9 \times 10^{-9}$ 1/h	$6.9 \times 10^{-9}$ 1/h	$6.9 \times 10^{-9}$ 1/h	$6.9 \times 10^{-9}$ 1/h	$6.9 \times 10^{-9}$ 1/h	$6.9 \times 10^{-9}$ 1/h	$6.9 \times 10^{-9}$ 1/h	$6.9 \times 10^{-9}$ 1/h
<b>Rated control supply voltage 24 V DC</b>	✓	✓	✓	✓	✓	✓	✓	✓

✓ Available  
-- Not available

1) The outputs are only safe when an external contactor is used.

# Safety Relays

## SIRIUS 3TK28

### Safety relays

PU (UNIT, SET, M) = 1  
 PS\* = 1 unit  
 PG = 41L



3TK28 26-2BB4



3TK28 45-1HB40



3TK28 45-1HB41



3TK28 45-2DB40



3TK28 10-0BA01



3TK28 10-1BA41

Rated control supply voltage $U_s$	Start	OFF-delay $t_v$	DT	Screw terminals	DT	Spring-type terminals
V		s		Order No.	Price per PU	Order No. Price per PU

#### Basic units

##### With floating enabling circuits

3TK28 26						
• 24 DC	Auto/monitored	--		3TK28 26-1BB40	A	3TK28 26-2BB40
• 24 ... 240 AC/DC	Auto/monitored	--		3TK28 26-1CW30	A	3TK28 26-2CW30

##### With time-delay enabling circuits

3TK28 26 $t_v$						
• 24 DC	Auto/monitored	0.05 ... 3	A	3TK28 26-1BB41	A	3TK28 26-2BB41
• 24 ... 240 AC/DC	Auto/monitored	0.05 ... 3	A	3TK28 26-1CW31	A	3TK28 26-2CW31
• 24 DC	Auto/monitored	0.5 ... 30	A	3TK28 26-1BB42	A	3TK28 26-2BB42
• 24 ... 240 AC/DC	Auto/monitored	0.5 ... 30	A	3TK28 26-1CW32	A	3TK28 26-2CW32
• 24 DC	Auto/monitored	5 ... 300	A	3TK28 26-1BB44	A	3TK28 26-2BB44
• 24 ... 240 AC/DC	Auto/monitored	5 ... 300	A	3TK28 26-1CW34	A	3TK28 26-2CW34

#### Multi-function units with electronic enabling circuits

3TK28 45 "Automatic and monitored start"						
• 24 DC	1/1	--	A	3TK28 45-1HB40	B	3TK28 45-2HB40
<b>3TK28 45 <math>t_v</math> "Automatic and monitored start"</b>						
• 24 DC	1/1	0.05 ... 3	A	3TK28 45-1HB41	B	3TK28 45-2HB41
	1/1	0.5 ... 30	A	3TK28 45-1HB42	B	3TK28 45-2HB42
	1/1	5 ... 300	A	3TK28 45-1HB44	B	3TK28 45-2HB44
<b>3TK28 45 "Monitored start"</b>						
• 24 DC	--/2	--	A	3TK28 45-1DB40	B	3TK28 45-2DB40
<b>3TK28 45 <math>t_v</math> "Monitored start"</b>						
• 24 DC	--/2	0.05 ... 3	A	3TK28 45-1DB41	B	3TK28 45-2DB41
	--/2	0.5 ... 30	A	3TK28 45-1DB42	B	3TK28 45-2DB42
	--/2	5 ... 300	C	3TK28 45-1DB44	B	3TK28 45-2DB44
<b>3TK28 45 "OK button"</b>						
• 24 DC	1/1	--	A	3TK28 45-1EB40	B	3TK28 45-2EB40
<b>3TK28 45 <math>t_v</math> "OK button"</b>						
• 24 DC	1/1	0.05 ... 3	A	3TK28 45-1EB41	B	3TK28 45-2EB41
	1/1	0.5 ... 30	A	3TK28 45-1EB42	B	3TK28 45-2EB42
<b>3TK28 45 <math>t_v</math> "Spring-type interlocking"</b>						
• 24 DC	--/2	0.05 ... 3	A	3TK28 45-1FB41	B	3TK28 45-2FB41
	--/2	0.5 ... 30	A	3TK28 45-1FB42	B	3TK28 45-2FB42
	--/2	5 ... 300	B	3TK28 45-1FB44	B	3TK28 45-2FB44
<b>3TK28 45 <math>t_v</math> "Solenoid interlocking"</b>						
• 24 DC	--/2	0.05 ... 3	A	3TK28 45-1GB41	B	3TK28 45-2GB41
	--/2	0.5 ... 30	A	3TK28 45-1GB42	B	3TK28 45-2GB42
	--/2	5 ... 300	C	3TK28 45-1GB44	B	3TK28 45-2GB44







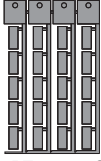

#### Standstill monitors

3TK28 10-0						
• 24 DC		0.2... 6	A	3TK28 10-0BA01	A	3TK28 10-0BA02
• 230 AC		0.2... 6	A	3TK28 10-0GA01	A	3TK28 10-0GA02
• 400 AC		0.2... 6	A	3TK28 10-0JA01	B	3TK28 10-0JA02

#### Overspeed monitors

3TK28 10-1 for NPN/PNP proximity switches and encoders						
• 24 DC		0 ... 600	A	3TK28 10-1BA41	A	3TK28 10-1BA42
• 120 ... 240 AC/DC		0 ... 600	A	3TK28 10-1KA41	A	3TK28 10-1KA42
<b>3TK28 10-1 for NAMUR proximity switches and encoders</b>						
• 24 DC		0 ... 600	A	3TK28 10-1BA41-0AA0	A	3TK28 10-1BA42-0AA0
• 120 ... 240 AC/DC		0 ... 600	A	3TK28 10-1KA41-0AA0	A	3TK28 10-1KA42-0AA0

#### Accessories



Use	Version	DT	Order No.	Price per PU	PU (UNIT, SET, M)	PS*	PG
<b>Blank labels</b>							
 3RT19 00-1SB20	For 3TK28		<b>Unit labeling plates</b> for SIRIUS devices 20 mm x 7 mm, pastel turquoise	▶	<b>3RT19 00-1SB20</b>	100	340 units 41B
	For 3TK28		<b>Inscription labels for sticking</b> for SIRIUS devices				
			<ul style="list-style-type: none"> <li>• 19 mm x 6 mm, pastel turquoise</li> <li>• 19 mm x 6 mm zinc yellow</li> </ul>	C	<b>3RT19 00-1SB60</b>	100	3 060 units 41B
				C	<b>3RT19 00-1SD60</b>	100	3 060 units 41B
<b>Push-in lugs and covers</b>							
 3RP19 03	For 3TK28		<b>Push-in lugs</b> For screw fixing, 2 units are required for each device	▶	<b>3RP19 03</b>	1	10 units 41H
 3RP19 02	For 3TK28 26		<b>Sealable covers</b> for securing against unauthorized adjustment of setting knobs	B	<b>3TK28 26-0DA00-0HA0</b>	1	5 units 41L
<b>Adapters and connection cables for overspeed monitors</b>							
 3TK28 10-1A	For 3TK28 10-1		<b>Adapters</b> for connecting encoders of type Siemens/Heidenhain				
			<ul style="list-style-type: none"> <li>• 15-pole</li> </ul>	A	<b>3TK28 10-1A</b>	1	1 unit 41L
 3TK28 10-1B			<ul style="list-style-type: none"> <li>• 25-pole</li> </ul>	A	<b>3TK28 10-1B</b>	1	1 unit 41L
 3TK28 10-0A	For 3TK28 10-1		<b>Connection cables</b> for connecting the overspeed monitor to the 3TK28 10-1A or 3TK28 10-1B adapter	A	<b>3TK28 10-0A</b>	1	1 unit 41L
<b>Tools for opening spring-type terminals</b>							
 3RA29 08-1A	For auxiliary circuit connections		<b>Screwdrivers</b> For all SIRIUS devices with spring-type terminals 3.0 mm x 0.5 mm, length approx. 200 mm, titanium gray/black, partially insulated	▶	<b>3RA29 08-1A</b>	1	1 unit 41B
					<b>Spring-type terminals</b>		

# Safety Relays

## SIRIUS 3TK28

### 3TK2826 with relay enabling circuits

#### Technical specifications

Type		3TK28 26-.BB40	3TK28 26-.CW30	3TK28 26-.BB41 3TK28 26-.BB42 3TK28 26-.BB44	3TK28 26-.CW31 3TK28 26-.CW32 3TK28 26-.CW44
<b>General data</b>					
<b>Standards</b>		EN 60204-1, EN ISO 12100, EN 954-1, IEC 61508			
<b>Test certificates</b>		TÜV, UL, CSA			
<b>Safety-oriented output contacts</b>					
• Instantaneous $FK_{rel}$		4		2	
• Time-delayed $FK_{rel(t)}$		--		2	
<b>Safety-oriented semiconductor outputs</b>					
• Instantaneous $FK_{el}$		--			
• Time-delay $FK_{el(t)}$		--			
<b>Signaling contacts <math>MK_{rel}</math></b>		1	2		3
<b>Semiconductor signaling outputs <math>MK_{rel}</math></b>		2	--	2	--
<b>Sensor inputs S</b>		1			
<b>Cascading inputs KAS/BS</b>		1			
<b>Degree of protection</b> acc. to EN 60529					
• Enclosure		IP40			
• Terminals		IP20			
<b>Shock resistance</b> sine wave	<i>g</i> /ms	8/10			
<b>Permissible mounting positions</b>		Any			
<b>Touch protection</b> acc. to EN 61140 or EN 60900		Finger-safe			
<b>Height</b>	mm	106: screw terminals; 108: spring-type terminals			
<b>Width</b>	mm	45			
<b>Depth</b>	mm	116			
<b>Weight</b>	kg	0.350			
<b>Connection type</b>		 <b>Screw terminals</b>			
• Terminal screw		M 3 (standard screwdriver, size 2 and Pozidriv 2)			
• Solid	mm <sup>2</sup>	1 x (0.5 ... 4)/2 x (0.5 ... 2.5)			
• Finely stranded with end sleeve	mm <sup>2</sup>	1 x (0.5 ... 2.5)/2 x (0.5 ... 1.5)			
• AWG cables, solid or stranded	AWG	2 x (24 ... 16)			
• Tightening torque	Nm	0.8 ... 1.2			
<b>Connection type</b>		 <b>Spring-type terminals</b>			
• Solid	mm <sup>2</sup>	2 x (0.25 ... 1.5)			
• Finely stranded, with end sleeves acc. to DIN 4622	mm <sup>2</sup>	2 x (0.25 ... 1.0)			
• Finely stranded	mm <sup>2</sup>	2 x (0.25 ... 1.5)			
• Stripped length	mm	10			
<b>Electrical specifications</b>					
<b>Rated control supply voltage <math>U_s</math></b>	V	24 DC	24 ... 240 AC/DC	24 DC	24 ... 240 AC/DC
<b>Operating range</b>					
• AC operation	V	--	0.9 ... 1.1 x $U_s$	--	0.9 ... 1.1 x $U_s$
• DC operation	V	0.85 ... 1.2 x $U_s$	0.9 ... 1.1 x $U_s$	0.85 ... 1.2 x $U_s$	0.9 ... 1.1 x $U_s$
<b>Measurement voltage</b>	V	--			
<b>Response value <math>U_{resp}</math></b>	mV	--			
<b>Rated insulation voltage <math>U_i</math></b>					
• For control circuit	V	--			
• For outputs	V	300			
<b>Rated impulse withstand voltage <math>U_{imp}</math></b>					
• For control circuit	V	--			
• For outputs	V	4000			
<b>Rated power</b>	W	3			
<b>Frequency ranges</b>	Hz	50/60			
<b>Rated operational current <math>I_e</math> (relay outputs) at</b>					
• AC-15 at 115 V	A	13/14, 23/24, 33/34, 43/44: 4 51/52: 3	13/14, 23/24, 33/34, 43/44: 4 51/52: 3	13/14, 23/24, 33/34, 43/44: 4 51/52: 3	13/14, 23/24, 33/34, 43/44: 4 51/52: 3
• AC-15 at 230 V	A	13/14, 23/24, 33/34, 43/44: 4 51/52: 3	13/14, 23/24, 33/34, 43/44: 4 51/52: 3	13/14, 23/24, 47/48, 57/58: 4 31/32, 61/62: 3	13/14, 23/24, 33/34, 43/44: 4 51/52: 3
• DC-13 at 24 V	A	13/14, 23/24, 33/34, 43/44: 4 51/52: 2	13/14, 23/24, 33/34, 43/44: 4 51/52: 2, 63/64: 1	13/14, 23/24, 47/48, 57/58: 4 31/32, 61/62: 2	13/14, 23/24, 47/48, 57/58: 4 31/32, 61/62: 2 73/74: 1
• DC-13 at 115 V	A	0.2	0.2	0.2	0.2
• DC-13 at 230 V	A	0.1	0.1	0.1	0.1
<b>Rated operational current <math>I_e</math> (semiconductor outputs) at</b>					
• DC-13 at 24 V	A	64, 75: 0.5	--	74, 84: 0.5	--
• DC-13 at 230 V	A	--	--	--	--



### 3TK2826 with relay enabling circuits

1  
2  
3  
4  
5  
6  
7  
8  
9  
10  
11  
12  
13

Type		3TK28 26-.BB40	3TK28 26-.CW30	3TK28 26-.BB41 3TK28 26-.BB42 3TK28 26-.BB44	3TK28 26-.CW31 3TK28 26-.CW32 3TK28 26-.CW44
<b>Electrical specifications (continued)</b>					
<b>Electrical endurance</b>	Oper. cycles	--			
<b>Mechanical endurance</b>	Oper. cycles	10 <sup>7</sup>			
<b>Switching frequency z</b>	1/h	2000			
<b>Conventional thermal current I<sub>th</sub></b>	A	Summation current max. 12			
<b>Conventional thermal current I<sub>th</sub></b>					
• 1 contact	A	4			
• 2 contacts	A	4			
• 3 contacts	A	4			
• 4 contacts	A	3			
<b>Fusing for output contacts</b>					
Fuse links LV HRC Type 3NA, DIAZED Type 5SB, NEOZED Type 5SE, gL/gG operational class					
• gL/gG	A	4			
• Quick	A	6			
<b>Maximum line resistance</b>	Ω	1000			
<b>Cable length from terminal to terminal</b>	m	2000			
With Cu 1.5 mm <sup>2</sup> and 150 nF/km					
<b>Times</b>					
<b>Bridging of voltage dips, supply voltage</b>	ms	Min. 10			
(only internal, no outputs)					
<b>Make-time t<sub>E</sub></b>					
• For automatic start typ.	ms	50 + debounce time			
• For automatic start max.	ms	50 + debounce time			
• For automatic start after mains failure typ	ms	Approx. 8000 starting time			
• For automatic start after mains failure max	ms	Approx. 8000 starting time			
• For monitored start typ.	ms	50 + debounce time			
• For monitored start max.	ms	50 + debounce time			
<b>Release time t<sub>R</sub></b>					
• For sensor typ.	ms	50 + deb. time	50 + deb. time	--	--
• For sensor max.	ms	--	--	50+ deb. time	50+ deb. time
• For mains failure typ.	ms	75	--	75	--
• For mains failure max.	ms	125	300	125	320
<b>Recovery time t<sub>W</sub></b>					
• After sensor	ms	Min. 250		Min. 250	Min. 250
• After mains failure	s	Min. 200		Min. 600	Min. 200
<b>Minimum command duration t<sub>B</sub></b>					
• Sensor input	ms	30			
• ON button	s	0.2 ... 5			
• Cascading input	s	--			
<b>Simultaneity t<sub>G</sub></b>	ms	∞			
<b>Temperatures</b>					
<b>Permissible ambient temperature</b>					
• During operation	°C	-25 ... +60			
• During storage	°C	-40 ... +80			
<b>Safety specifications</b>					
<b>Safety integrity level SIL CL</b>		3			
acc. to IEC 61508					
<b>Performance level PL</b>	acc. to ISO 13849-1	e			
<b>Safety category CAT</b>		4			
acc. to EN 954-1					
<b>Type</b>	acc. to EN 574	--			
<b>Probability of a dangerous failure</b>					
• Per hour (PFH <sub>D</sub> )	1/h	7.8 x 10 <sup>-9</sup>	7.8 x 10 <sup>-9</sup>	7.8 x 10 <sup>-9</sup>	7.8 x 10 <sup>-9</sup>
• On demand (PFD)		--	--	--	--
<b>Proof-test interval T1</b>	a	20			
<b>Environmental data</b>					
<b>EMC</b>		EN 60947-5-1			
<b>Vibrations</b>	acc. to EN 60068-2-6				
• Frequency	Hz	5 ... 500			
• Amplitude	mm	0.075			
<b>Climatic withstand capability</b>		EN 60068-2-1, EN 60068-2-2, EN 60068-2-14, EN 60068-2-30			
<b>Clearances in air and creepage distances</b>		EN 60947-1			

<sup>1)</sup> Time-delayed enabling circuit: ≤ 300 ms adjustable.

# Safety Relays

## SIRIUS 3TK28

### 3TK2845 with electronic enabling circuits

#### Technical specifications

Type		3TK28 45...B40	3TK28 45...B41 3TK28 45...B42 3TK28 45...B44
<b>General data</b>			
<b>Standards</b>		EN 60204-1, EN ISO 12100, EN 954-1, IEC 61508	
<b>Test certificates</b>		TÜV, UL, CSA	
<b>Safety-oriented output contacts</b>			
• Instantaneous $FK_{rel}$		2	1
• Time-delayed $FK_{rel}(tv)$		--	1
<b>Safety-oriented semiconductor outputs</b>			
• Instantaneous $FK_{el}$		2	1
• Time-delay $FK_{el}(tv)$		--	1
<b>Signaling contacts <math>MK_{rel}</math></b>			
<b>Semiconductor signaling outputs <math>MK_{rel}</math></b>		1	
<b>Sensor inputs S</b>		2	
<b>Cascading inputs KAS/BS</b>		1	
<b>Degree of protection</b> acc. to EN 60529		IP40 IP20	
• Enclosure			
• Terminals			
<b>Shock resistance</b> sine wave	g/ms	8/10 and 15/5	
<b>Permissible mounting positions</b>		Any	
<b>Touch protection</b> acc. to EN 61140 or EN 60900		Finger-safe	
<b>Height</b>	mm	102: Screw terminals; 104: Spring-type terminals	
<b>Width</b>	mm	45	
<b>Depth</b>	mm	120	
<b>Weight</b>	kg	0.400	
<b>Connection type</b>		⊕ <b>Screw terminals</b>	
• Terminal screw		M 3 (standard screwdriver, size 2 and Pozidriv 2)	
• Solid	mm <sup>2</sup>	1 x (0.5 ... 4)/2 x (0.5 ... 2.5)	
• Finely stranded with end sleeve	mm <sup>2</sup>	1 x (0.5 ... 2.5)/2 x (0.5 ... 1.5)	
• AWG cables, solid or stranded	AWG	2 x (24 ... 16)	
• Tightening torque	Nm	0.8 ... 1.2	
<b>Connection type</b>		∞ <b>Spring-type terminals</b>	
• Solid	mm <sup>2</sup>	2 x (0.25 ... 1.5)	
• Finely stranded, with end sleeves acc. to DIN 46228	mm <sup>2</sup>	2 x (0.25 ... 1.5)	
• Finely stranded	mm <sup>2</sup>	2 x (0.25 ... 1.5)	
<b>Electrical specifications</b>			
<b>Rated control supply voltage <math>U_s</math></b>	V	24 DC	
<b>Operating range</b> DC operation	V	0.85 ... 1.15 × $U_s$	
<b>Rated insulation voltage <math>U_i</math></b>			
• For control circuit	V	50	
• For outputs	V	50/300	
<b>Rated impulse withstand voltage <math>U_{imp}</math></b>			
• For control circuit	V	500	
• For outputs	V	500/4000	
<b>Rated power at <math>U_s</math></b>	W	2.5	
<b>Frequency ranges</b>	Hz	--	
<b>Rated operational current <math>I_e</math> (relay outputs) at</b>			
• AC-15 at 115 V	A	--	
• AC-15 at 230 V	A	3	
• DC-13 at 24 V	A	1	
• DC-13 at 115 V	A	--	
• DC-13 at 230 V	A	0.1	
<b>Rated operational current <math>I_e</math> (semiconductor outputs) at</b>			
• DC-13 at 115 V	A	0.5	
• DC-13 at 230 V	A	--	
<b>Electrical endurance</b>	Operat- ing cycles	Unlimited	
<b>Mechanical endurance</b>	Operat- ing cycles	10 <sup>5</sup>	
<b>Switching frequency z</b>	1/h	2000	

#### Technical specifications



Type		3TK28 45-..B40	3TK28 45-..B41 3TK28 45-..B42 3TK28 45-..B44
<b>Electrical specifications (continued)</b>			
<b>Conventional thermal current <math>I_{th}</math></b>		--	
<b>Conventional thermal current <math>I_{th}</math></b>			
• 1 contact	A	--	
• 2 contacts	A	--	
• 3 contacts	A	--	
• 4 contacts	A	--	
<b>Fusing for output contacts</b>			
Fuse links LV HRC Type 3NA, DIAZED Type 5SB, NEOZED Type 5SE, gL/gG operational class			
• gL/gG		Not required	
• Quick		Not required	
<b>Maximum line resistance</b>	Ω	1000	
<b>Cable length from terminal to terminal</b>	m	1000	
With Cu 1.5 mm <sup>2</sup> and 150 nF/km			
<b>Times</b>			
<b>Bridging of voltage dips, supply voltage (only internal, no outputs)</b>	ms	25	
<b>Make-time <math>t_E</math></b>			
• For automatic start typ.	ms	60	
• For automatic start max.	ms	100	
• For automatic start after mains failure typ.	ms	--	
• For automatic start after mains failure max.	ms	--	
• For monitored start typ.	ms	60	
• For monitored start max.	ms	100	
<b>Release time <math>t_R</math></b>			
• For sensor typ.	ms	45	--
• For sensor max.	ms	--	0.05 ... 300 Adjustable
• For mains failure typ.	ms	25	25
• For mains failure max.	ms	30	30
<b>Recovery time <math>t_W</math></b>			
• After sensor	ms	400	
• After mains failure	s	Max. 8	
<b>Minimum command duration <math>t_G</math></b>			
• Sensor input	ms	45	
• ON button input	ms	200 ... 5000	
• Cascading input	ms	45	
<b>Simultaneity <math>t_G</math></b>	ms	∞	
<b>Temperatures</b>			
<b>Permissible ambient temperature</b>			
• During operation	°C	-25 ... +60	
• During storage	°C	-40 ... +80	
<b>Safety specifications</b>			
<b>Safety integrity level SIL CL</b>		3	
acc. to IEC 61508			
<b>Performance level PL</b>		e	
acc. to ISO 13849-1			
<b>Safety category CAT</b>		4	
acc. to EN 954-1			
<b>Type</b>		acc. to EN 574	
<b>Probability of a dangerous failure</b>			
• Per hour (PFH <sub>D</sub> )	1/h	6.86 x 10 <sup>-9</sup>	
• On demand (PFD)		--	
<b>Proof-test interval T1</b>	a	20	
<b>Environmental data</b>			
<b>EMC</b>		IEC 60947-5-1, IEC 60000-4-3, IEC 60000-4-5, IEC 60000-4-6	
<b>Vibrations</b>			
acc. to EN 60068-2-6			
• Frequency	Hz	5 ... 500	
• Amplitude	mm	0.075	
<b>Climatic withstand capability</b>		EN 60068-2-78	
<b>Clearances in air and creepage distances</b>		EN 60947-1	

# Safety Relays

## SIRIUS 3TK28

### 3TK2810 with special functions

#### Technical specifications

Type		3TK28 10
<b>General data</b>		
<b>Standards</b>		EN 60204-1, EN ISO 12100, EN 954-1, IEC 61508
<b>Test certificates</b>		TÜV, UL, CSA
<b>Safety-oriented output contacts</b>		
• Instantaneous $FK_{rel}$		4
• Time-delayed $FK_{rel(tv)}$		--
<b>Safety-oriented semiconductor outputs</b>		
• Instantaneous $FK_{el}$		--
• Time-delay $FK_{el(tv)}$		--
<b>Signaling contacts <math>MK_{rel}</math></b>		1
<b>Semiconductor signaling outputs <math>MK_{rel}</math></b>		2
<b>Sensor inputs S</b>		1
<b>Cascading inputs KAS/BS</b>		--
<b>Degree of protection</b> acc. to EN 60529		
• Enclosure		IP40
• Terminals		IP20
<b>Shock resistance</b> sine wave	g/ms	8/10
<b>Permissible mounting positions</b>		Any
<b>Touch protection</b> acc. to EN 61140 or EN 60900		Finger-safe
<b>Height</b>	mm	106: screw terminals; 108: spring-type terminals
<b>Width</b>	mm	45
<b>Depth</b>	mm	116
<b>Weight</b>	kg	0.500
<b>Connection type</b>		 <b>Screw terminals</b>
• Terminal screw		M 3 (standard screwdriver, size 2 and Pozidriv 2)
• Solid	mm <sup>2</sup>	1 x (0.5 ... 4)/2 x (0.5 ... 2.5)
• Finely stranded with end sleeve	mm <sup>2</sup>	1 x (0.5 ... 2.5)/2 x (0.5 ... 1.5)
• AWG cables, solid or stranded	AWG	2 x (24 ... 16)
• Tightening torque	Nm	0.8 ... 1.2
<b>Connection type</b>		 <b>Spring-type terminals</b>
• Solid	mm <sup>2</sup>	2 x (0.25 ... 1.5)
• Finely stranded, with end sleeves acc. to DIN 46228	mm <sup>2</sup>	2 x (0.25 ... 1.0)
• Finely stranded	mm <sup>2</sup>	2 x (0.25 ... 1.5)
<b>Electrical specifications</b>		
<b>Rated control supply voltage <math>U_s</math></b>	V	24 DC, 230/400 AC
<b>Operating range</b>		
• AC operation	V	0.8 ... 1.1 x $U_s$
• DC operation	V	0.9 ... 1.15 x $U_s$
<b>Measurement voltage</b>	V	Max. 690
<b>Response value <math>U_{resp}</math></b>	V	20 ... 400 adjustable
<b>Rated insulation voltage <math>U_i</math></b>		
• For control circuit	V	300
• For outputs	V	690
<b>Rated impulse withstand voltage <math>U_{imp}</math></b>		
• For control circuit	V	6/4
• For outputs	V	6
<b>Rated power at <math>U_s</math></b>	W	3
<b>Frequency ranges</b>	Hz	50/60
<b>Rated operational current <math>I_e</math> (relay outputs) at</b>		
• AC-15 at 115 V	A	--
• AC-15 at 230 V	A	3 (NO contacts); 2 (NC contacts)
• DC-13 at 24 V	A	2
• DC-13 at 115 V	A	--
• DC-13 at 230 V	A	--
<b>Rated operational current <math>I_e</math> (semiconductor outputs) at</b>		
• DC-13 at 115 V	A	0.1
• DC-13 at 230 V	A	--
<b>Electrical endurance</b>	Operat- ing cycles	$2 \times 10^5$
<b>Mechanical endurance</b>	Operat- ing cycles	$5 \times 10^7$
<b>Switching frequency z</b>	1/h	1200

#### Technical specifications

Type	3TK28 10	
<b>Electrical specifications (continued)</b>		
<b>Conventional thermal current <math>I_{th}</math></b>	A	5, summation current max. 8
<b>Conventional thermal current <math>I_{th}</math></b>		
• 1 contact	A	5
• 2 contacts	A	5
• 3 contacts	A	5
• 4 contacts	A	--
<b>Fusing for output contacts</b>		
Fuse links LV HRC Type 3NA, DIAZED Type 5SB, NEOZED Type 5SE, gL/gG operational class		
• gL/gG		--
• Quick	A	5
<b>Maximum line resistance</b>	$\Omega$	--
<b>Cable length from terminal to terminal</b>	m	--
With Cu 1,5 mm <sup>2</sup> and 150 nF/km		
<b>Times</b>		
<b>Release time <math>t_R</math></b>		
• For sensor typ.	ms	--
• For sensor max.	ms	6 adjustable
• For mains failure typ.	ms	--
• For mains failure max.	ms	--
<b>Simultaneity <math>t_G</math></b>	ms	$\infty$
<b>Temperatures</b>		
<b>Permissible ambient temperature</b>		
• During operation	$^{\circ}\text{C}$	-25 ... +60
• During storage	$^{\circ}\text{C}$	-40 ... +75
<b>Safety specifications</b>		
<b>Safety integrity level SIL CL</b>		3
acc. to IEC 61508		
<b>Performance level PL</b>		e
acc. to ISO 13849-1		
<b>Safety category CAT</b>		4
acc. to EN 954-1		
<b>Probability of a dangerous failure</b>		
• Per hour (PFH <sub>D</sub> )	1/h	1,49 x 10 <sup>-9</sup>
• On demand (PFD)		--
<b>Proof-test interval T1</b>	a	20

# Safety Relays

## SIRIUS 3TK28

### Dimensional drawings

#### Dimension drawings <sup>1)</sup>

##### 3TK28 safety relays with screw terminals

###### 3TK28 26 with screw terminals

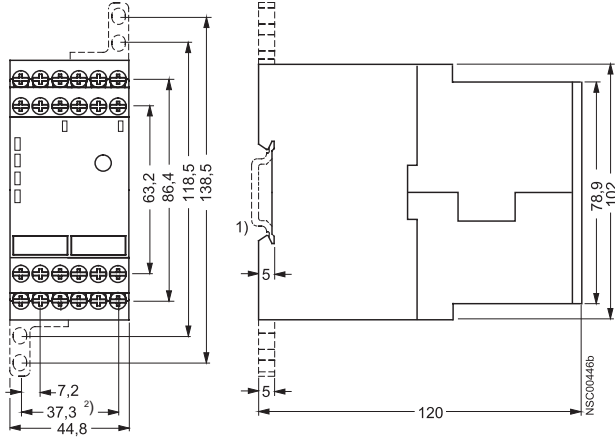

##### 3TK28 safety relays with Spring Loaded terminals

###### 3TK28 with spring loaded terminals

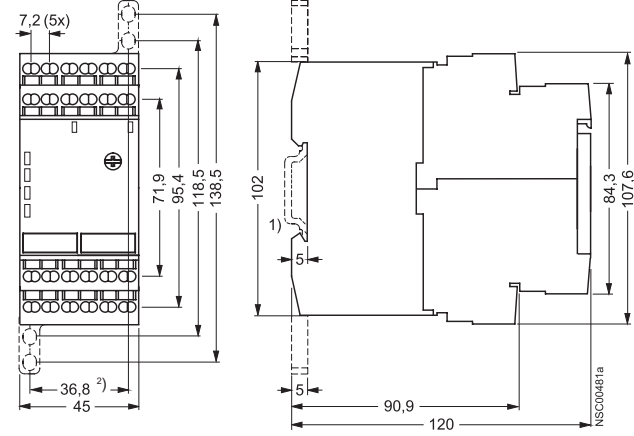

1) For 35 mm standard rail to EN 50 022.

2) Dimension for screw mounting. Screw mounting with 2 plug-in tabs 3RP19 03 per 3TK28 unit.

##### 3TK28 10 with screw terminals

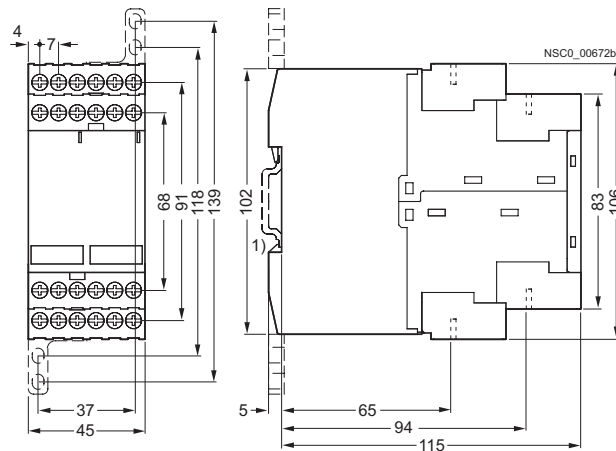

##### 3TK28 10 with spring loaded terminals

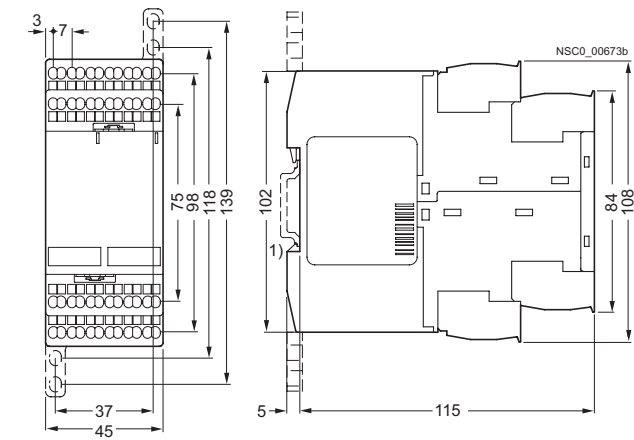

1) For standard mounting rail TH 35 according to EN 60715.

## Overview

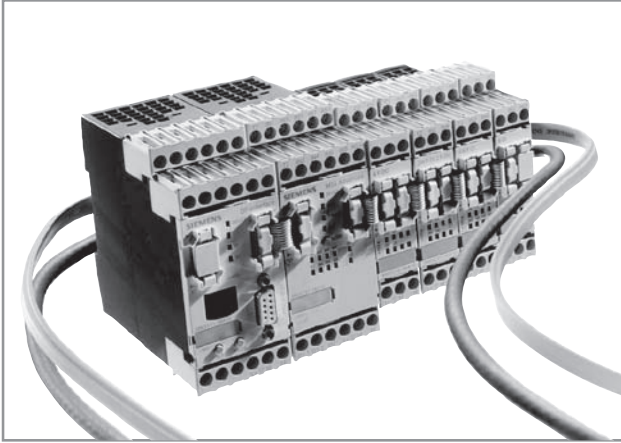

SIRIUS 3RK3 Modular Safety System

The 3RK3 Modular Safety System (MSS) is a freely parameterizable modular safety relay. Depending on the external circuit version, safety-oriented applications up to Performance Level e according to EN ISO 13849-1 or SIL 3 according to IEC 62061 can be realized.

The modular safety relay enables the interconnection of several safety applications.

The comprehensive error and status diagnostics provides the possibility of finding errors in the system and localizing signals from sensors. Plant downtimes can be reduced as the result.

The MSS comprises the following system components:

- Central units
- Expansion modules
- Interface modules
- Diagnostics modules
- Parameterization software
- Accessories

### Central units

#### MSS Basic

The 3RK3 Basic central unit is used wherever more than three safety functions need to be evaluated and the wiring parameterization of safety relays would involve great cost and effort. It reads in inputs, controls outputs and communicates through an interface module with higher-level control systems. An application's entire safety program is processed in the central unit. The 3RK3 Basic central unit is the lowest expansion level and fully functional on its own, without the optional expansion modules.

#### MSS Advanced

The 3RK3 Advanced central unit is the consistent expansion of the Basic central unit with the functionality of an AS-i safety monitor. In addition to having a larger volume of project data and scope of functionality, it can be integrated into AS-Interface and therefore makes use of the many different possibilities offered by this bus system. The function can be optionally activated in the central unit.

The service-proven insulation piercing method of AS-Interface enables not only the distributed expansion of the project data volume using safe AS-i outputs, safe AS-i sensors and other MSS Advanced or safety monitors (F cross traffic) but also a highly flexible adaptation of the application, e.g. very fast connection of AS-i outputs, LV HRC command devices, position switches with and without interlocking, or light arrays.

Safety-oriented disconnection using MSS or by distributed means using safe AS-i outputs and the formation of switch-off groups can be implemented very easily. The same applies for any subsequent modifications. They are now easily possible by re-addressing, i.e. re-wiring is no longer necessary.

The AS-i bus is connected directly to the central unit.

#### MSS ASIsafe

The MSS ASIsafe basic and MSS ASIsafe extended central units are a logical development of the AS-i safety monitors based on the 3RK3 Modular Safety System.

Like MSS Advanced, MSS ASIsafe detects – in a comparable way to the safety monitors – safe sensor technology on the AS-i bus and switches actuators off in a safety-oriented manner via a configurable safety logic. It stands out by virtue of its greater project data volume, wider range of functions and the possibility of increasing the the integrated I/O project data volume by means of expansion modules from the MSS system family. In this case the range of functions, such as the number and type of the logic elements that can be interconnected, is equivalent to that of MSS Advanced.

#### Expansion modules

With the optional expansion modules, both safety-related and standard, the system is flexibly adapted to the required safety applications.

#### Interface modules

The DP interface module is used for transferring diagnostics data and device status data to a higher-level PROFIBUS network, e.g. for purposes of visualization via HMI. When using the Basic central unit, 32-bit cyclic data can be exchanged with the control system. If an Advanced/ASIsafe central unit is used, the number is doubled to 64-bit cycle data. The acyclic calling of diagnostics data is possible with both central units.

#### Diagnostics modules

Faults like a cross-circuit, for instance, are displayed directly on the diagnostic display. The fault is diagnosed directly in plain text by the detailed alarm message. The device is fully functional upon delivery. No programming is required.

#### Parameterization software

Using the MSS ES graphical parameterization tool it is very easy to create the safety functions as well as their logical links on the PC. You can define disconnection ranges, ON-delays, OFF-delays and other dependent factors, for example.

MSS ES also offers comprehensive functions for diagnostics and commissioning. Documentation of the MSS hardware layout and the parameterized logic is drawn up automatically.

# Safety Relays

## SIRIUS 3RK3 Modular Safety System

### General data

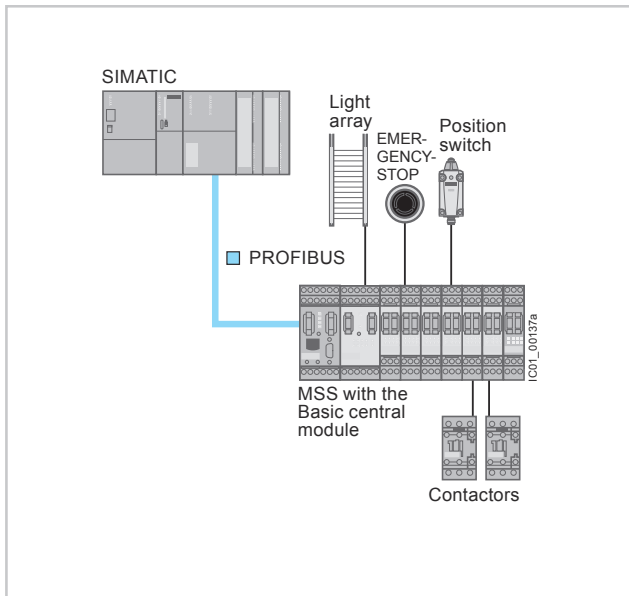

System configuration with the Basic central unit

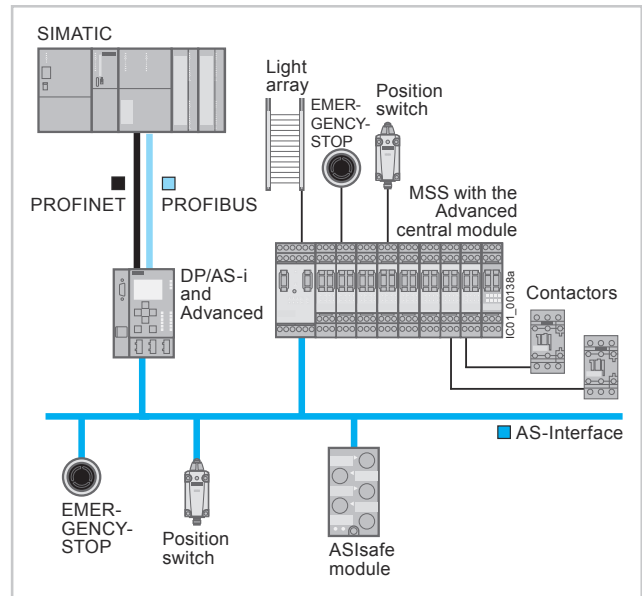

System configuration with the Advanced central unit

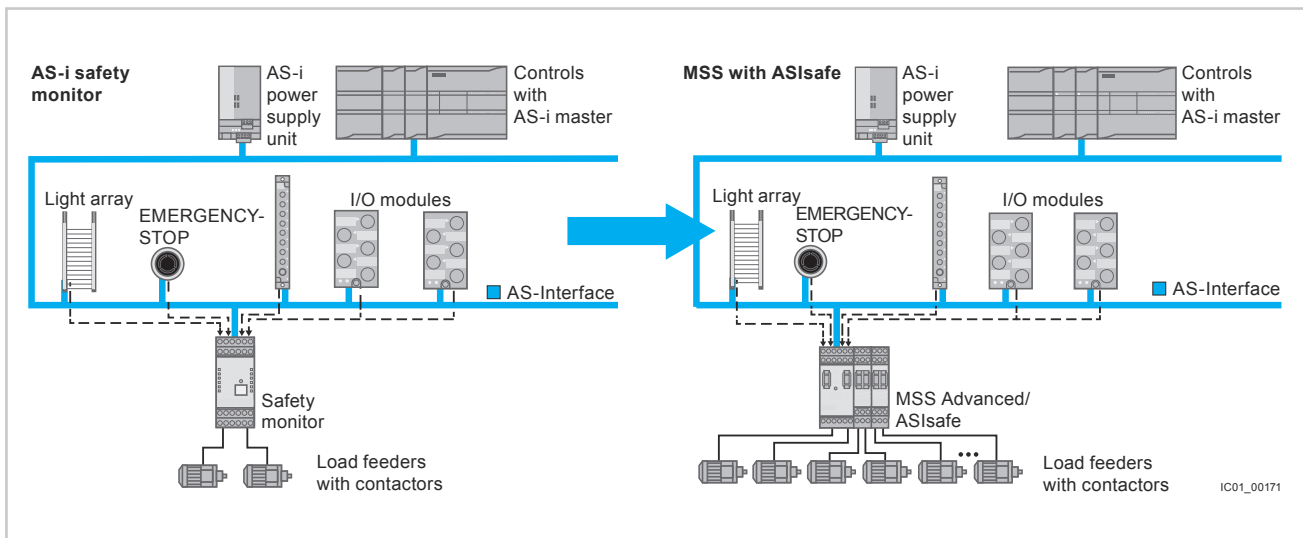

Further development of the system design: from the safety monitor to MSS Advanced/MSS ASIsafe



# Safety Relays

## SIRIUS 3RK3 Modular Safety System

General data

1  
2  
3  
4  
5  
6  
7  
8  
9  
10  
11  
12  
13

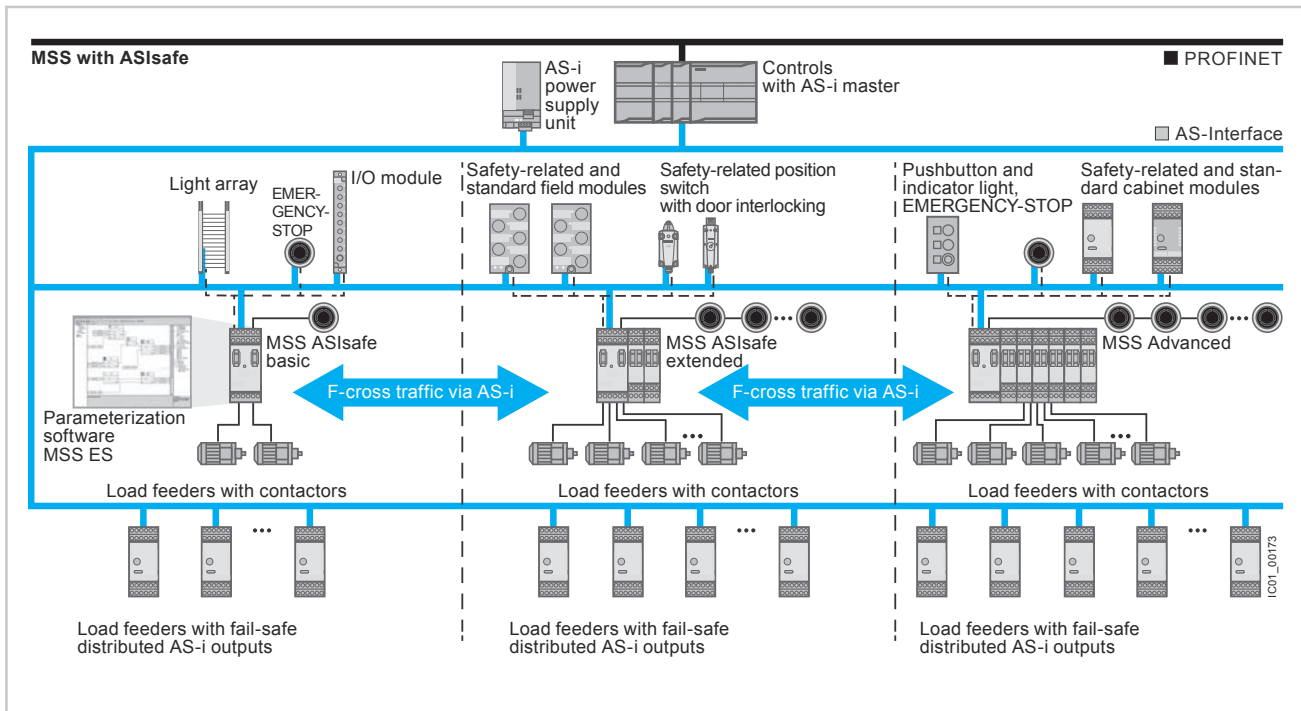

MSS with ASIsafe

### Order No. scheme

Digit of the Order No.	1st - 4th	5th	6th	7th	8th	9th	10th	11th	12th	
	□□□□	□	□	□	-	□	□	□	□	
Modular safety system	3 R K 3									
Device type	□									
Device type	□ □									
Connection type	□									
Communications	□ □ □									
Version	□									
Example	3 R K 3	1	1	1	-	1	A	A	1	0

### Note:

The Order No. scheme is presented here merely for information purposes and for better understanding of the logic behind the order numbers.

For your orders, please use the order numbers quoted in the catalog in the selection and ordering data.

# Safety Relays

## SIRIUS 3RK3 Modular Safety System

### General data

#### Benefits

- More functionality and flexibility through freely configurable safety logic
- Suitable for all safety applications thanks to compliance with the highest safety standards in factory automation
- For use all over the world through compliance with all product-relevant, globally established certifications
- Modular hardware configuration
- Parameterization by means of software instead of wiring
- Removable terminals for greater plant availability
- Distributed collection from sensors and disconnection of actuators through AS-Interface
- All MSS ES logic functions are also usable for AS-Interface, e. g. muting, protective door with interlocking
- Up to 12 independent safe switch-off groups on the AS-i bus
- Volume of project data can be greatly increased by means of AS-Interface
- Up to 50 two-channel enabling circuits per system

#### Communication through PROFIBUS

The 3RK3 Modular Safety System can be connected to PROFIBUS through the DP interface and can exchange data with higher-level control systems.

The MSS supports among other things:

- Baud rates up to 12 Mbit/s
- Automatic baud rate detection
- Cyclic services (DPV0) and acyclic services (DPV1)
- Exchange of 32-bit cyclic data with MSS Basic or 64-bit cyclic data with MSS Advanced/MSS ASIsafe
- Diagnostics using data record invocations

#### AS-Interface communication

The 3RK3 Modular Safety System can be integrated into AS-Interface with the Advanced and ASIsafe central units.

- MSS can read in up to 31 AS-i sensors
- Up to 12 preprocessed signals per MSS can be placed on the AS-i bus, e.g. for F-cross traffic or for disconnecting safe AS-i outputs
- Safe cross-traffic between MSS Advanced and MSS ASIsafe or with other AS-i safety monitors
- Standard signals, e.g. for acknowledgement, can also be placed on the bus

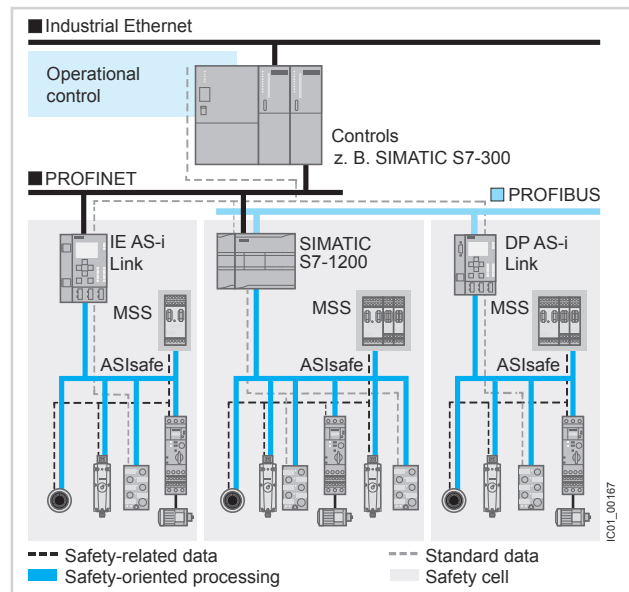

Integration of MSS into AS-Interface as ASIsafe Solution Local

MSS with communication function [see page 13/147 onwards](#).

Accessories [see page 13/149 onwards](#).

For more information on AS-Interface with ASIsafe, [see also Chapter 14 on Industrial Communication](#).

### Selection and ordering data



PU (UNIT, SET, M) = 1  
PS\* = 1 unit



3RK3 111-1AA10



3RK3 121-1AC00  
3RK3 122-1AC00  
3RK3 131-1AC10

Version	DT	Screw terminals 	DT	Spring-type terminals 	
		Order No.	Price per PU	Order No.	Price per PU
<b>Central units</b>					
<b>3RK3 Basic</b>					
Central unit with safety-oriented inputs and outputs					
<ul style="list-style-type: none"> <li>• 8 non-fail-safe inputs</li> <li>• 1 two-channel relay output</li> <li>• 1 two-channel solid-state output</li> </ul>					
Max. 7 expansion modules can be connected					
<u>Note:</u>					
Memory module 3RK3 931-0AA00 is included in the scope of supply.					
	▶	<b>3RK3 111-1AA10</b>	A	<b>3RK3 111-2AA10</b>	
<b>3RK3 Advanced</b>					
Central units for connecting to AS-Interface with safety-oriented inputs and outputs and extended scope of functions					
<ul style="list-style-type: none"> <li>• 8 non-fail-safe inputs</li> <li>• 1 two-channel relay output</li> <li>• 1 two-channel solid-state output</li> </ul>					
Max. 9 expansion modules can be connected					
<u>Note:</u>					
Memory module 3RK3 931-0AA00 is included in the scope of supply.					
	▶	<b>3RK3 131-1AC10</b>	A	<b>3RK3 131-2AC10</b>	
<b>3RK3 ASIsafe basic</b>					
Central units for connecting to AS-Interface with safety-oriented inputs and outputs and extended scope of functions					
<ul style="list-style-type: none"> <li>• 2 fail-safe inputs</li> <li>• 6 non-fail-safe inputs</li> <li>• 1 two-channel relay output</li> <li>• 1 two-channel solid-state output</li> </ul>					
No expansion modules can be connected					
<u>Note:</u>					
Memory module 3RK3 931-0AA00 is included in the scope of supply.					
	A	<b>3RK3 121-1AC00</b>	A	<b>3RK3 121-2AC00</b>	
<b>3RK3 ASIsafe extended</b>					
Central units for connecting to AS-Interface with safety-oriented inputs and outputs and extended scope of functions					
<ul style="list-style-type: none"> <li>• 4 fail-safe inputs</li> <li>• 4 non-fail-safe inputs</li> <li>• 1 two-channel relay output</li> <li>• 1 two-channel solid-state output</li> </ul>					
Max. 2 expansion modules can be connected					
<u>Note:</u>					
Memory module 3RK3 931-0AA00 is included in the scope of supply.					
	A	<b>3RK3 122-1AC00</b>	A	<b>3RK3 122-2AC00</b>	

Note:

More information on the Internet at [www.siemens.com/sirius-mss](http://www.siemens.com/sirius-mss).

# Safety Relays

## SIRIUS 3RK3 Modular Safety System

Expansion modules, interface modules,  
operating & monitoring modules

### Selection and ordering data

PU (UNIT, SET, M) = 1  
PS\* = 1 unit



3RK3 211-1AA10  
3RK3 221-1AA10  
3RK3 231-1AA10  
3RK3 242-1AA10



3RK3 251-1AA10





3RK3 311-1AA10  
3RK3 321-1AA10



3RK3 511-1BA10



3RK3 611-3AA00

Version	DT	Screw terminals 	DT	Spring-type terminals 	
		Order No.	Price per PU	Order No.	Price per PU
<b>Expansion modules</b>					
<b>4/8 F-DI</b> Safety-related input modules • 8 inputs	A	<b>3RK3 211-1AA10</b>	A	<b>3RK3 211-2AA10</b>	
<b>2/4 F-DI 1/2 F-RO</b> Safety-related input/output modules • 4 inputs • 2 single-channel relay outputs	A	<b>3RK3 221-1AA10</b>	A	<b>3RK3 221-2AA10</b>	
<b>2/4 F-DI 2F-DO</b> Safety-related input/output modules • 4 inputs • 2 two-channel solid-state outputs	▶	<b>3RK3 231-1AA10</b>	A	<b>3RK3 231-2AA10</b>	
<b>4/8 F-RO</b> Safety-oriented output modules • 8 single-channel relay outputs	A	<b>3RK3 251-1AA10</b>	▶	<b>3RK3 251-2AA10</b>	
<b>4 F-DO</b> Safety-oriented output modules • 4 two-channel solid-state outputs	A	<b>3RK3 242-1AA10</b>	▶	<b>3RK3 242-2AA10</b>	
<b>8 DI</b> Standard input module • 8 inputs	▶	<b>3RK3 321-1AA10</b>	▶	<b>3RK3 321-2AA10</b>	
<b>8 DO</b> Standard output module • 8 solid-state outputs	A	<b>3RK3 311-1AA10</b>	A	<b>3RK3 311-2AA10</b>	
<b>Interface modules</b>					
<b>DP interface</b> PROFIBUS DP interface, 12 Mbit/s, RS 485, 32-bit cyclic data exchange with Basic central unit or 64-bit with Advanced central unit, acyclic exchange of diagnostics data	A	<b>3RK3 511-1BA10</b>	A	<b>3RK3 511-2BA10</b>	
<b>Operating and monitoring modules</b>					
<b>Diagnostics module</b>	A	<b>3RK3 611-3AA00</b>		--	

#### Note:

Connection cable required, see page 13/149.

More information on the Internet at  
[www.siemens.com/sirius-mss](http://www.siemens.com/sirius-mss).

#### Selection and ordering data

Version	DT	Order No.	Price per PU	PU (UNIT, SET, M)	PS*
<b>Connection cables (essential accessory)</b>					
<b>Connection cables</b>					
For connection of					
Central units with expansion modules or interface module	Diagnostics modules with central unit or interface module				
✓	✓	• Length 0.025 m (flat) ▶	<b>3UF7 930-0AA00-0</b>	1	1 unit
--	✓	• Length 0.1 m (flat) ▶	<b>3UF7 931-0AA00-0</b>	1	1 unit
--	✓	• Length 0.3 m (flat) ▶	<b>3UF7 935-0AA00-0</b>	1	1 unit
--	✓	• Length 0.5 m (flat) ▶	<b>3UF7 932-0AA00-0</b>	1	1 unit
--	✓	• Length 0.5 m (round) ▶	<b>3UF7 932-0BA00-0</b>	1	1 unit
--	✓	• Length 1.0 m (round) ▶	<b>3UF7 937-0BA00-0</b>	1	1 unit
--	✓	• Length 2.5 m (round) ▶	<b>3UF7 933-0BA00-0</b>	1	1 unit
<b>PC cables and adapters</b>					
<b>PC cables</b> ▶					
For connecting to the serial interface of a PC/PG, for communication with 3RK3 through the system interface					
<b>USB PC cables</b> ▶					
For connecting to the USB interface of a PC/PG, for communication with 3RK3 through the system interface, recommended for use in connection with 3RK3					
<b>USB/serial adapters</b> B					
For connecting the RS 232 PC cable to the USB interface of a PC					
<b>Interface covers</b>					
<b>Interface covers</b> ▶					
For system interface					
<b>Memory modules</b>					
<b>Memory modules</b> ▶					
For backing up the complete parameterization of the 3RK3 Modular Safety System without a PC/PG through the system interface					
<b>Door adapters</b>					
<b>Door adapters</b>					
For external connection of the system interface, e.g. outside a control cabinet					
<b>Push-in lugs</b>					
<b>Push-in lugs for screw fixing</b> ▶					
e.g. on mounting plate, 2 units required per device					
Can be used for 3RK3					
<b>Manuals</b>					
<b>Manuals for the 3RK3 Modular Safety System (MSS)</b>					
• English C					

✓ Available  
-- Not available



# Safety Relays

## SIRIUS 3RK3 Modular Safety System

### Accessories

#### Parameterization, startup and diagnostics software for 3RK3

- Runs under Windows XP Professional (Service Pack 2 or 3), Windows 7 32/64 Bit Professional/Ultimate/Enterprise (Service Pack 1)
- Delivered without PC cable. Please order separately, see page 13/149.

Version	DT	Order No.	Price per PU	PU (UNIT, SET, M)	PS*
<b>Modular Safety System ES 2008 Basic</b>					
 <p>3ZS1 314-4CC10-0YA5</p>	<b>Floating license for one user</b> Engineering software in limited-function version for diagnostics purposes, software and documentation on CD, 3 languages (German/English/French), communication through the system interface				
	• License key on USB stick, Class A	A	<b>3ZS1 314-4CC10-0YA5</b>	1	1 unit
	• License key download, Class A	▶	<b>3ZS1 314-4CE10-0YB5</b>	1	1 unit
<b>Modular Safety System ES 2008 Standard</b>					
 <p>3ZS1 314-5CC10-0YA5</p>	<b>Floating license for one user</b> Engineering software, software and documentation on CD, 3 languages (German/English/French), communication through system interface				
	• License key on USB stick, Class A	B	<b>3ZS1 314-5CC10-0YA5</b>	1	1 unit
	• License key download, Class A	▶	<b>3ZS1 314-5CE10-0YB5</b>	1	1 unit
	A	<b>3ZS1 314-5CC10-0YD5</b>	1	1 unit	
	▶	<b>3ZS1 314-5CC10-0YL5</b>	1	1 unit	
<b>Modular Safety System ES 2008 Premium</b>					
 <p>3ZS1 314-6CC10-0YA5</p>	<b>Floating license for one user</b> Engineering software, software and documentation on CD, 3 languages (German/English/French), communication through PROFIBUS or the system interface, online diagnostics via PROFIBUS, creating, importing and exporting macros				
	• License key on USB stick, Class A	▶	<b>3ZS1 314-6CC10-0YA5</b>	1	1 unit
	• License key download, Class A	▶	<b>3ZS1 314-6CE10-0YB5</b>	1	1 unit
	A	<b>3ZS1 314-6CC10-0YD5</b>	1	1 unit	
	▶	<b>3ZS1 314-6CC10-0YL5</b>	1	1 unit	

### Technical specifications

#### Central units and expansion modules

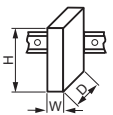
Type	Central units				Expansion modules							
	Basic	Advanced	ASIsafe basic	ASIsafe extended	4/8F-DI	2/4 F-DI 1/2 F-RO	2/4 F-DI 2F-DO	4/8 F-RO	4 F-DO	8 DI	8 DO	
Dimensions (W x H x D)												
												
• Screw terminals	mm	45 x 111 x 124				22.5 x 111 x 124			45 x 111 x 124		22.5 x 111 x 124	
• Spring-type terminals	mm	45 x 113 x 124				22.5 x 113 x 124			45 x 113 x 124		22.5 x 113 x 124	
<b>Device data</b>												
<b>Shock resistance (sine pulse)</b>	g/ms	15/11										
<b>Touch protection</b> according to EN 50274 and IEC 60529		IP20										
<b>Permissible mounting position</b>		Vertical mounting surface (+10°/-10°), deviating mounting positions are permitted for reduced ambient temperature										
<b>Minimum distances</b>		For heat dissipation through convection from the devices 25 mm to the ventilation openings (top and bottom)										
<b>Permissible ambient temperature</b>												
• During operation	°C	-20 ... +60										
• During storage and transport	°C	-40 ... +85										
<b>Number of sensor inputs (single-channel)</b>												
• Fail-safe		--	--	2	4	8	4	4	--	--	--	--
• Not fail-safe		8	8	6	4	--	--	--	--	--	8	8
<b>Number of test outputs</b>		2	2	2	2	2	2	2	--	--	--	--
<b>Number of outputs</b>												
• Relay outputs												
- Single channel		--	--	--	--	--	2	--	8	--	--	--
- Two-channel		1	1	1	1	--	--	--	--	--	--	--
• Solid-state outputs												
- Single channel		--	--	--	--	--	--	--	--	--	--	8
- Two-channel		1	1	1	1	--	--	2	--	4	--	--
<b>Weight</b>	g	300	300	300	300	160	160	160	400	135	125	160
<b>Installation altitude above sea level</b>	m	2 000										
<b>Environmental data</b>												
<b>EMC interference immunity</b>		IEC 60947-5-1										
<b>Vibrations</b>												
• Frequency	Hz	5 ... 500										
• Amplitude	mm	0.75										
<b>Climatic withstand capability</b>		IEC 60068-2-78										
<b>Electrical specifications</b>												
<b>Rated control supply voltage <math>U_s</math></b> according to IEC 61131-2	V	24 DC 15 % <sup>1)</sup>										
<b>Operating range</b>		0.85 ... 1.15 x $U_s$										
<b>Rated insulation voltage <math>U_i</math></b>	V	300	300	300	300	50	300	50	300	50	50	50
<b>Rated impulse voltage <math>U_{imp}</math></b>	kV	4	4	4	4	0,5	4	0,5	4	0,5	0,5	0,5
<b>Total current consumption</b>	mA	185	185	185	185	60	85	85	140	8	78	60
<b>Rated power at <math>U_s</math></b>	W	4.5	4.5	4.5	4.5	1.5	2	2	3	4.8	1.9	1.5
<b>Utilization categories</b> acc. to IEC 60947-5-1 (relay outputs)												
• AC-15 at 230 V	A	2	2	2	2	--	2	--	2	--	--	--
• DC-13 at 24 V (semiconductor outputs)	A	1	1	1	1	--	1	--	1	--	--	--
• DC-13 at 24 V	A	1.5	1.5	1.5	1.5	--	--	1	--	2	--	0.5
<b>Mechanical endurance</b> During rated operation	Operating cycles (relay)	10 x 10 <sup>6</sup>	10 x 10 <sup>6</sup>	10 x 10 <sup>6</sup>	10 x 10 <sup>6</sup>	--	10 x 10 <sup>6</sup>	--	10 x 10 <sup>6</sup>	--	--	--

<sup>1)</sup> Device current supply through a power supply unit acc. to IEC 60536 protection class (SELV or PELV).

# Safety Relays

## SIRIUS 3RK3 Modular Safety System

### Technical data

Type	Central units				Expansion modules							
	Basic	Advanced	ASIsafe basic	ASIsafe extended	4/8F-DI	2/4 F-DI 1/2 F-RO	2/4 F-DI 2F-DO	4/8 F-RO	4 F-DO	8 DI	8 DO	
<b>Electrical specifications (cont.)</b>												
<b>Switching frequency z</b> for rated operational current	1/h	1 000	1 000	1 000	1 000	--	1 000	1 000	360	1 000	--	1 000
<b>Conventional thermal current <math>I_{th}</math></b>	A	2/1.5	2/1.5	2/1.5	2/1.5	--	1	1	3	2	--	0.5
<b>Protection for output contacts</b>												
Fuse links LV HRC Type 3NA, DIAZED Type 5SB, NEOZED Type 5SE												
• Operational class gG	A	4	4	4	4	--	4	--	4	--	--	--
• Operational class quick response	A	6	6	6	6	--	6	--	6	--	--	--
<b>Safety specifications</b>												
<b>Probability of a dangerous failure</b>												
• Per hour (PFH <sub>d</sub> )	1/h	$5.14 \times 10^{-9}$	$2.8 \times 10^{-9}$	$2.8 \times 10^{-9}$	$2.8 \times 10^{-9}$	$1.89 \times 10^{-9}$	$3.79 \times 10^{-9}$	$2.7 \times 10^{-9}$	$7.15 \times 10^{-9}$	$3.18 \times 10^{-9}$	--	--
• On demand (PFD)	1/h	$1.28 \times 10^{-5}$	$1.7 \times 10^{-4}$	$1.7 \times 10^{-4}$	$1.7 \times 10^{-4}$	$4.29 \times 10^{-6}$	$5.85 \times 10^{-6}$	$8.34 \times 10^{-6}$	$4.36 \times 10^{-5}$	$2.2 \times 10^{-5}$	--	--
<b>Parameters for cables</b>												
<b>Line resistance</b>		100	100	100	100	100	100	100	--	--	100	--
<b>Cable length from terminal to terminal</b> With Cu 1.5 mm <sup>2</sup> and 150 nF/km	m	1 000	1 000	1 000	1 000	1 000	1 000	1 000	--	--	1 000	--
<b>Conductor capacity</b>	nF	330	330	330	330	330	330	330	--	--	330	--

### Interface and diagnostics modules

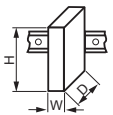
Type	Interface modules		Diagnostics modules	
Dimensions (W x H x D)				
				
• Screw terminals	mm	45 x 111 x 124		96 x 60 x 44
• Spring-type terminals	mm	45 x 113 x 124		--
<b>Device data</b>				
<b>Shock resistance (sine pulse)</b>	g/ms	15/11		
<b>Touch protection</b> according to EN 50274 and IEC 60529		IP20		
<b>Permissible mounting position</b>		Vertical mounting surface (+10°/-10°), deviating mounting positions are permitted for reduced ambient temperature		
<b>Minimum distances</b>		For heat dissipation through convection from the devices 25 mm to the ventilation openings (top and bottom)		
<b>Permissible ambient temperature</b>				
• During operation	°C	-20 ... +60		
• During storage and transport	°C	-40 ... +85		
<b>Weight</b>	g	270		90
<b>Installation altitude above sea level</b>	m	2 000		
<b>Environmental data</b>				
<b>EMC interference immunity</b>		IEC 60947-5-1		
<b>Vibrations</b>				
• Frequency	Hz	5 ... 500		
• Amplitude	mm	0.75		
<b>Climatic withstand capability</b>		IEC 60068-2-78		
<b>Electrical specifications</b>				
<b>Rated control supply voltage <math>U_s</math></b> according to IEC 61131-2	V	24 DC 15 %	24 DC 15 % via connecting cable to the central unit	
<b>Operating range</b>		0.85 ... 1.15 x $U_s$		
<b>Rated insulation voltage <math>U_i</math></b>	V	50		
<b>Rated impulse voltage <math>U_{imp}</math></b>	kV	0,5		
<b>Total current consumption</b>	mA	--		24
<b>Rated power at <math>U_s</math></b>	W	--		0.6



### Application

The 3RK3 Modular Safety System can be used for all safety-oriented requirements in the manufacturing industry and offers the following safety functions:

	Symbol	MSS Basic	MSS Advanced, MSS ASIsafe
<b>Monitoring functions</b>			
<b>Universal monitoring</b> Evaluation of any binary signals from single-channel and two-channel sensors		--	✓
<b>EMERGENCY-STOP</b> Evaluation of EMERGENCY-STOP devices with positive-opening contacts		✓	✓
<b>Safety shutdown mats</b> Evaluation of safety shutdown mats with NC contacts and/or cross-circuit detection		✓	✓
<b>Protective door monitoring</b> Evaluation of protective door signals and/or protective flap signals		✓	✓
<b>Protective door interlocking mechanism</b> Evaluation of protective doors with interlocking and locking/unlocking of this device		--	✓
<b>Enabling switches</b> Evaluation of OK buttons with NO contact		✓	✓
<b>Two-hand operator controls</b> Evaluation of two-hand operation consoles		✓	✓
<b>ESPE monitoring</b> Evaluation of electro-sensitive protective equipment such as light arrays and laser scanners		✓	✓
<b>Muting</b> Short-time bridging of electro-sensitive protective equipment, 2/4 sensors in parallel, 4 sensors sequentially		--	✓
<b>Operating mode selector switches</b> Evaluation of operating mode selector switches with NO contacts		✓	✓
<b>Monitoring of AS-i (AS-i 2F-DI)</b> Logic element for monitoring of AS-i input slaves		--	✓

✓ Available  
-- Not available

	Symbol	MSS Basic	MSS Advanced, MSS ASIsafe
<b>Logic operation functions</b>			
<b>AND</b>		✓	✓
<b>OR</b>		✓	✓
<b>XOR</b>		✓	✓
<b>NAND</b>		✓	✓
<b>NOR</b>		✓	✓
<b>Negation</b>		✓	✓
<b>Flip-flop</b>		✓	✓
<b>Counter functions</b>			
<b>Counter 0 -&gt; 1</b>		✓	✓
<b>Counter 1 -&gt; 0</b>		✓	✓
<b>Counter 0 -&gt; 1/1 -&gt; 0</b>		✓	✓
<b>Timer functions</b>			
<b>With ON-delay</b>		✓	✓
<b>Passing make contact</b>		✓	✓
<b>With OFF-delay</b>		✓	✓
<b>Clock pulsing</b>		✓	✓
<b>Start functions</b>			
<b>Monitored start</b>		✓	✓
<b>Manual start</b>		✓	✓
<b>Output functions</b>			
<b>Standard output</b>		✓	✓
<b>F output</b>		✓	✓
<b>AS-i output function</b>		--	✓
<b>Status functions</b>			
<b>Element status</b>		--	✓

# Safety Relays

## SIRIUS 3RK3 Modular Safety System

### Dimensional drawings

#### Dimensional drawings

Central module with screw terminals

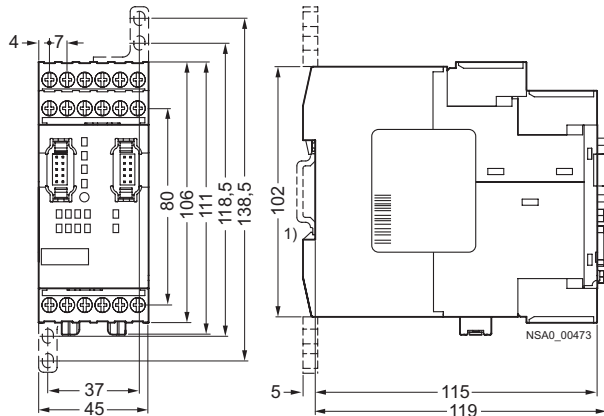

Central module with spring-type terminals

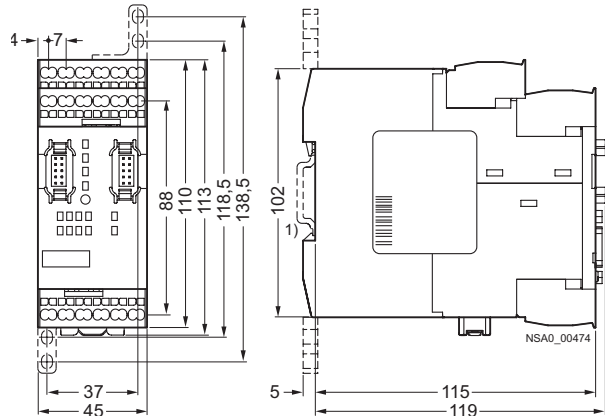

Expansion module with screw terminals

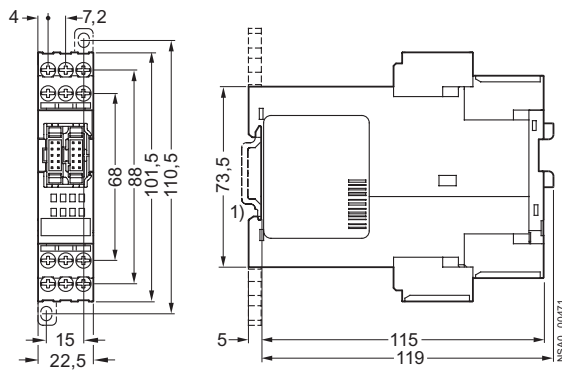

Expansion module with spring-type terminals

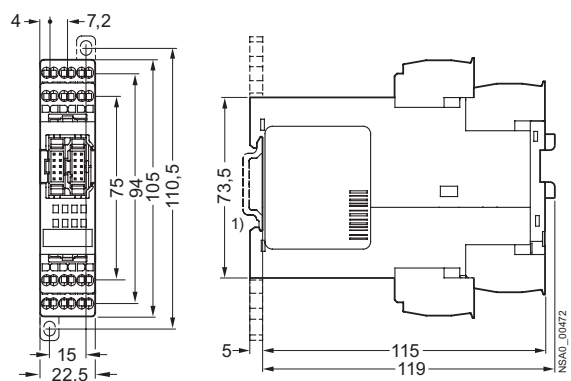

Interface module with screw terminals

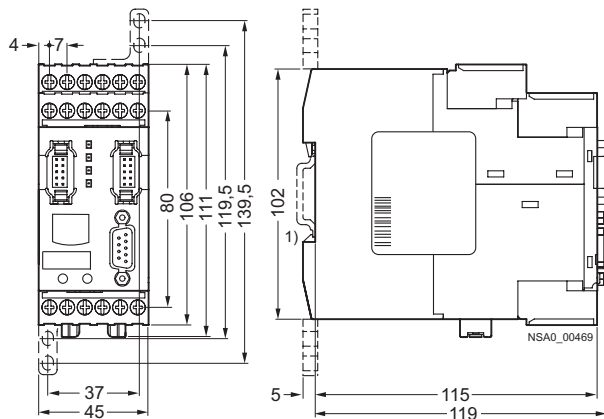

Interface module with spring-type terminals

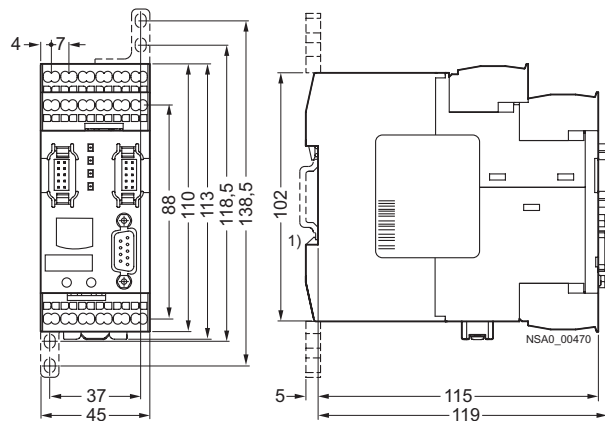

1) For standard mounting rail TH 35 according to EN 60715.