

Contents

Pages

3SE International (IEC) Limit Switches

3SE5 General data

Overview 13/4 - 13/9

3SE5 plastic enclosures

3SE5, selection and ordering data, 31 mm width. 13/10 - 13/14

3SE5, selection and ordering data, 40 mm width. 13/15 - 13/18

3SE5, selection and ordering data, 50 mm width. 13/19 - 13/22

3SE5, selection and ordering data,
ambient temperature to -40 C 13/23 - 13/26

3SE5 metal enclosures

3SE5, selection and ordering data, 31 mm width. 13/27 - 13/30

3SE5, selection and ordering data, 40 mm width. 13/31 - 13/34

3SE5, selection and ordering data, 56 mm width. 13/35 - 13/38

3SE5, selection and ordering data, 56 mm width, XL. 13/39 - 13/41

3SE5, selection and ordering data, ambient
temperature to -40 C. 13/42 - 13/44

3SE5 metal enclosures, compact design

3SE5, selection and ordering data. 13/45 - 13/46

3SE5 open type design

3SE5, selection and ordering data. 13/47

3SE5 accessories and spare parts

3SE5, selection and ordering data. 13/48 - 13/50

3SE5 support information

Technical specifications. 13/51

Configuration - actuation and operating travel 13/52 - 13/57

Dimensional drawings. 13/58 - 13/60

Circuit diagrams. 13/61

3SE03 North American (NEMA) Limit Switches

Plug-in and NEMA 6P Submersible

Overview 13/62

Technical specifications, modular plug-in and
NEMA Type 6P submersible 13/63

Ordering and selection data:

Modular, plug-in metal housing. 13/64

NEMA type 6P submersible, prewired cable 13/65

NEMA type 6P submersible, prewired receptacle 13/66

Modular, Plug-in and NEMA 6P submersible as components. 13/67

Levers for plug-in and NEMA type 6P submersible 13/68 - 13/69

Wiring Diagrams 13/70

Dimension Diagrams 13/71 - 13/73

Metal Enclosure

Ordering and selection data 13/74 - 13/75

Specifications 13/74 - 13/75

Technical Data. 13/75

Dimension drawings 13/74 - 13/75



Plastic, 31 mm



Plastic, 50 mm



Metal, 40 mm



Metal, 56 mm



3SE5, Open-type



3SE5, Compact Design



3SE03, Modular Plug-in



3SE03, Metal Enclosure

Contents

Pages

3SE Mechanical Safety

3SE7 Cable-operated Switches

Overview, technical data and travel diagrams	13/76
Selection and ordering data	13/77 - 13/79
Dimension drawings	13/80

3SE5 interlock switches with separate actuator

Overview	13/81
3SE5, selection and ordering data, plastic	13/82 - 13/83
3SE5, selection and ordering data, metal	13/84 - 13/85
3SE5, selection and ordering data, actuators	13/86
3SE2, selection and ordering data, plastic	13/87
Technical data	13/88
3SE5, operation and operating travel diagrams	13/89
3SE5, dimension drawings	13/90 - 13/91
3SE2, operation and operating travel diagrams	13/92
3SE2, dimension drawings	13/92

3SE5 interlock switches with solenoid locking

General data	13/93 - 13/94
3SE5, selection and ordering data, plastic enclosures	13/95
3SE5, selection and ordering data, metal enclosures	13/96
3SE5, selection and ordering data, actuators	13/97
Technical data	13/98
3SE5, Schematics, operation and operating travel diagrams	13/99
3SE5, dimension drawings	13/100

3SE5 / 3SE2 hinge switches

General data	13/101
3SE5, selection and ordering data, plastic	13/102
3SE5, selection and ordering data, metal	13/103
3SE2, selection and ordering data, plastic with integrated hinge	13/104
3SE5, contact blocks and operating travel diagrams	13/105
3SE5, dimension drawings	13/105
3SE2, technical data	13/106
3SE2, contact blocks and operating travel diagrams	13/106
3SE2, dimension drawings	13/106

3SE6 RFID Non-Contact Safety Switches

General data and system overview	13/107 - 13/108
Technical data	13/109
Selection and ordering data	13/110

3SE6 magnetic monitoring systems

General data	13/111
Selection and ordering data	13/112
Technical data	13/113
Dimension drawings	13/114
Circuit diagrams	13/115

3SB3 Two-hand Control.

3SB3, selection and ordering data	13/116
-----------------------------------	--------



3SE7



Metal, 40 mm



Interlock, Metal, 54 mm



Hinge, Plastic, 31 mm



3SE6 RFID Switch



3SE6, Magnet System



3SB3 Two-Hand Control

Contents

Pages

Safety Relays

SIRIUS 3SK1 Safety Relays

General data and system overview13/117 - 13/119
Selection and ordering data13/120 - 13/125
Technical data13/126
Cross reference from 3TK2813/127 - 13/128

SIRIUS 3TK28 Safety Relays

General data and system overview13/129 - 13/133
Selection and ordering data13/134 - 13/135
Technical data13/136 - 13/141
Dimensional drawings13/142

3RK3 Modular Safety System

General data and system overview13/143 - 13/146
Selection and ordering data13/147 - 13/150
Technical data13/151 - 13/152
Application data13/153
Dimensional drawings13/154



3SK1



3TK2845

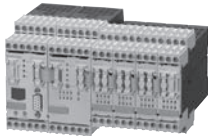

3RK3

Limit Switches and Safety

Introduction

Overview



3SE5 23.,
3SE5 21.
3SF1 2.4

3SE5 24.,
3SF1 244

3SE5 13.,
3SE5 11.,
3SF1 114

3SE5 12.,
3SF1 124

3SE5 16.

3SE5 232,
3SE5 212,
3SF1 2.4

3SE5 132,
3SE5 112,
3SF1 1.4

	Position switches, standard					Safety hinge switches	
Enclosure							
Plastic	✓	✓	✓	—	—	✓	✓
Metal	✓	—	✓	✓	✓	✓	✓
Dimensions (W x H x D) in mm	31 x 68 x 33	50 x 53 x 33	40 x 78 x 38	56 x 78 x 38	56 x 100 x 38	31 x 68 x 33	40 x 78 x 38
Degree of protection	IP65, IP66/IP67	IP66/IP67	IP66/IP67	IP66/IP67	IP66/IP67	IP65, IP66/IP67	IP66/IP67
Standards							
IEC 60947-5-1	Mounting and operating points acc. to EN 50047	Operating points acc. to EN 50047	Mounting and operating points acc. to EN 50041	Operating points acc. to EN 50041	Operating points acc. to EN 50047	Mounting and operating points acc. to EN 50047	Mounting and operating points acc. to EN 50041
Approvals	CE, UL, CSA, CCC			CE, UL, CSA, CCC		CE, UL, CSA, CCC	
Contact blocks							
2 slow-action contacts	1 NO + 1 NC, 2 NC		1 NO + 1 NC, 2 NC	—	—	1 NO + 1 NC	
2 snap-action contacts	1 NO + 1 NC		1 NO + 1 NC	—	—	1 NO + 1 NC	
• Short stroke	1 NO + 1 NC		✓	—	—	✓	
• With 2 x 2 mm contact gap	1 NO + 1 NC		✓	—	—	✓	
3 slow-action contacts	1 NO + 2 NC, 2 NO + 1 NC		1 NO + 2 NC, 2 NO + 1 NC	—	—	1 NO + 2 NC	
• With make-before-break	1 NO + 2 NC		1 NO + 2 NC	—	—	1 NO + 2 NC	
3 snap-action contacts	1 NO + 2 NC		1 NO + 2 NC	—	—	1 NO + 2 NC	
2 x (2 or 3 contacts)	—		—	—	✓	—	
Special features							
LED status display	✓		✓	—	—	✓	
Increased corrosion protection	✓		✓	—	✓	✓	
Explosion protection (ATEX)	—		✓	—	✓	✓	
ASIsafe integrated	✓		✓	—	—	✓	
Electrical specifications							
Insulation voltage U_i	400 V		400 V			400 V	
Conventional thermal current I_{the}	6 A/10 A (3-/2-pole)		6 A/10 A (3-/2-pole)			6 A/10 A (3-/2-pole)	
Connections							
Cable entry	1 x M20 x 1.5	2 x M20 x 1.5	1 x M20 x 1.5	3 x M20 x 1.5	1 x M20 x 1.5	1 x M20 x 1.5	1 x M20 x 1.5
M12 connector socket, 4-, 5- or 8-pole	✓	✓	✓	✓	✓	✓	✓
Connector socket, 6-pole + PE	—	—	✓	✓	—	—	—
Actuators							
Rounded plungers and roller plungers	✓		✓	—	—	—	
Roller and angular roller levers	✓		✓	—	—	—	
Spring rod	✓		✓	—	—	—	
Twist levers and rod actuators	✓		✓	—	—	—	
Fork lever	—		✓	—	—	—	
Hinge switches	—		—	—	—	✓	
Page							
Complete units	13/10, 13/27	13/19	13/15, 13/31	13/35	13/39	13/102	13/103
Modular system	13/13, 13/29	13/21	13/17, 13/33	13/37	13/40	—	—
Ambient temperature -40 °C	13/23, 13/42	13/23	13/26, 13/43	13/43	13/43	—	—
ASIsafe	on-line	on-line	on-line	on-line	—	on-line	on-line
ATEX	on-line	on-line	on-line	on-line	on-line	on-line	on-line

✓ Available
— Not available



3SE5 413,
3SE5 423

3SE5 250

3SE5 232,
3SE5 242,
3SF1 2.4

3SE5 112,
3SE5 122,
3SF1 1.4

3SE5 322,
3SE5 312,
3SF1 3.4

3SE63

	Compact design	Open-type	Safety switches with separate actuator		Safety switches with solenoid interlocking	RFID safety switch
Enclosure						
Plastic	—	✓	✓	✓	✓	✓
Metal	✓	—	✓	✓	✓	—
Dimensions (W x H x D) in mm	30 x .. x .., 40 x .. x ..	30 x 48.5 x 20	31 x 68 x 33, 50 x 53 x 33	40 x 78 x 38, 56 x 78 x 38	54 x 185 x 44	25 x 91 x 22
Degree of protection	IP66/IP67	IP10 or IP20	IP65, IP66/IP67	IP66/IP67	IP66/IP67	IP69K
Standards	—	Mounting and operating points acc. to EN 50047	Mounting acc. to EN 50047	Mounting acc. to EN 50041	EN 1088	Category 4 acc. to ISO 13849-1, PL e acc. to ISO 13849-1, SIL 3 acc. to IEC 61508
IEC 60947-5-1	—	—	—	—	—	—
Approvals	CE, UL, CSA	—	CE, TÜV, UL, CSA, CCC	CE, TÜV, UL, CSA, CCC	CE, TÜV, UL, CSA, CCC	CE, TÜV
Contact blocks						
2 slow-action contacts	—	1 NO + 1 NC	1 NO + 1 NC	—	—	—
2 snap-action contacts	1 NO + 1 NC	1 NO + 1 NC	—	—	—	—
• Short stroke	—	✓	—	—	—	—
• With 2 x 2 mm contact gap	—	✓	—	—	—	—
3 slow-action contacts	—	1 NO + 2 NC	1 NO + 2 NC	—	—	—
• With make-before-break	—	1 NO + 2 NC	—	—	—	—
3 snap-action contacts	—	1 NO + 2 NC	—	—	—	—
6 slow-action contacts	—	—	—	—	2 x (1 NO + 2 NC)	—
Special features						
LED status display	—	—	✓	—	✓	✓
Increased corrosion protection	—	—	✓	—	✓	✓
Explosion protection (ATEX)	—	—	✓	—	—	—
ASIsafe integrated	—	—	✓	—	✓	—
Electrical specifications						
Insulation voltage U_i	400 V	400 V	400 V	400 V	400 V	—
Conventional thermal current I_{the}	10 A	6 A	6 A	6 A	6 A	—
Connections						
Cable entry	—	—	1 x M20 x 1.5, 2 x M20 x 1.5	1 x M20 x 1.5, 3 x M20 x 1.5	3 x M20 x 1.5	—
M12 connector socket, 4-, 5- or 8-pole	✓	—	✓	✓	✓	✓
Molded cables	✓	—	—	—	—	—
AS-Interface	—	—	✓	✓	✓	—
Actuators						
Plungers, twist levers	✓	✓	—	—	—	—
Separate actuators	—	—	✓	—	✓	—
Page						
Complete units	13/46	13/47	13/82	13/85	13/95	—
Modular system	—	—	—	—	—	13/110
ASIsafe	—	—	on-line	on-line	on-line	—
ATEX	—	—	on-line	on-line	—	—

✓ Available
— Not available

Limit Switches

SIRIUS 3SE5 International Limit Switches

General Data

Overview

Position switches in the innovative SIRIUS 3SE5 series are modern in design, compact, modular and simple to connect.

Complete units

Popular versions of the position switches in standard enclosures are available as complete units.



Position switches with plastic and metal enclosures

Modular system

The 3SE5 series features a new modular system comprising different sizes of the basic switch and an actuator which must be ordered separately. Thanks to the modular construction of the switch the user can select the right solution for his application from numerous versions and install it himself in a very short time. The short delivery times of the modules enable fast replacement and thus ensure high plant availability.



Examples of selection options in the modular system

Design

Enclosure sizes

All enclosure versions have an integrated chlorinated rubber diaphragm for high functional safety in cold and aggressive environments.

The 3SE5 switches are available in five different enclosure sizes with 2 or 3 contacts and with the XL enclosure:

- Open-type position switch IP20 or IP10
- Plastic enclosures according to EN 50047 (31 mm wide), IP65, 1 cable entry
- Plastic enclosures (50 mm wide), IP66/IP67, 2 cable entries
- Metal enclosures according to EN 50047, (31 mm wide), IP66/IP67, 1 cable entry
- Plastic and metal enclosures according to EN 50041 (40 mm wide), IP66/IP67, 1 cable entry
- Metal enclosures (56 mm wide), IP66/IP67, 3 cable entries
- XL metal enclosures with 4 to 6 contacts, 56 mm wide, IP66/IP67, 3 cable entries

Various basic switches can be selected for the 3SE5 series:

- With contact blocks with two or three contacts (screw terminals) designed as slow-action or snap-action contacts; the slow-action contacts also make-before-break
- Optional LED status display
- With mounted four or five-pole M12 connector socket (available for the wide enclosures as an accessory for self-assembly)
- With 6-pole connector socket + PE on the metal enclosures
- With increased corrosion protection
- Versions for operating temperature to -40° C
- Metal enclosures for explosion protection (ATEX)
- AS-Interface version with integrated ASIsafe electronics for all enclosure designs

Actuator variants

All operating mechanisms can be rotate around the axis in increments of 22.5°. The following actuator variants are available:

- Standard, rounded and roller plungers
- Roller and angular roller levers
- Spring rods
- Twist levers and rod actuators
- Fork levers with twist actuator

The actuator rollers are available with various materials and diameters.

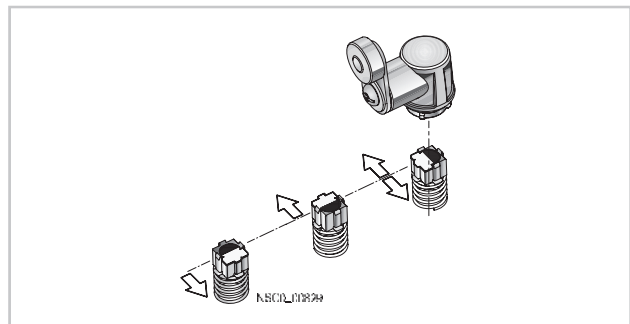

Twist actuators for twist levers and rod actuators, with setting of switching to right, left or right/left (standard for all twist actuators except version for fork levers)

Optional LED indicators

LED indicators available for all enclosure sizes



The enclosure versions can be supplied with an LED signaling indicator (1 × green + 1 × yellow). This is the first time that optical signaling equipment is also available for small standard enclosures according to EN 50047. The LED signaling indicators are available in all common voltages (24 V DC and 230 V AC).

Additional contacts

Exchangeable two and three-pole switching blocks for all enclosure sizes



The three-pole switching block (2 NC, 1 NO) in snap-action and slow-action is regularly available for all enclosure forms. It offers more switching through redundant shutdowns (2 NC contacts) with simultaneous signaling (1 NO contact). The same installation space is required as for a two-pole switching block.

Contact reliability

The new contact blocks ensure an extremely high contact stability. This applies even when the devices are switching low voltages and currents, e. g. 1 mA at 5 V DC.

Positive opening

The NC contacts of the switch are forced open mechanically, positively-driven and reliably by the plunger. This is referred to as "positive opening".

Mounting

Easy plug-in method – for fast replacement of the actuator head

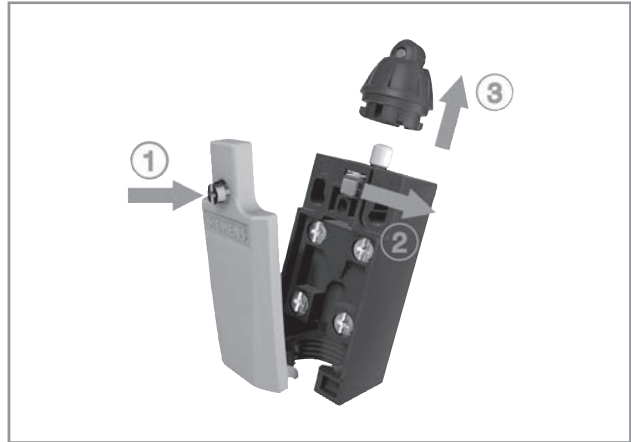

- (1) Open cover
- (2) Actuate locking lever
- (3) Replace the head (turnable by 16 x 22.5°)
- (4) Lock and close the cover

Fast connection method

For plastic enclosure with a width of 31 mm

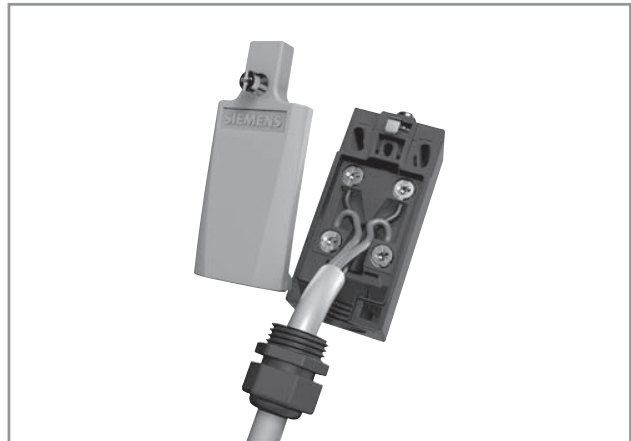

These position switches can be wired quickly and easily as an added customer benefit. The connecting cable is first connected to the terminals of the contact block and then guided through a slit into the cable gland opening. The time saved through this new connection method is approx. 20 to 25 %.

Limit Switches

SIRIUS 3SE5 International Limit Switches

General Data

Benefits

The 3SE5 position switches differ from the previous series through the following new characteristics:

- The modular design of the product range allows a number of versions with a smaller number of bearing types for enclosures and operating mechanisms.
- All actuators can be turned around the axis in increments of 22.5° (see picture on page 13/6).
- Rounded and roller plungers according to EN 50041 with 3 mm overtravel (total travel 9 mm) for greater tolerance when switching
- All enclosure sizes – now also including the small enclosure 31 mm wide – are optionally available with an LED signaling indicator (see picture on page 13/7).
- All enclosure versions have an integrated chlorinated rubber diaphragm (high functional safety in cold and aggressive environments).
- All contact blocks are replaceable (see page 13/49).
- The three-pole contact blocks are available for all enclosure sizes (see picture on page 13/7).
- Elements with 1 NO + 2 NC slow-action contacts with make-before-break and 2 NO + 1 NC
- The short-stroke contact block 1 NO + 1 NC improves the precision of the switching operation through a reduced actuation path.
- The contact block with 1 NO + 1 NC snap-action contacts with 2 x 2 mm contact opening is suitable for simultaneous disconnection and signaling, particularly in the elevator industry
- NEW: XL enclosures for accommodating two 2- or 3-pole contact blocks
- The plastic enclosure with a width of 31 mm has simple and fast wiring equipment which makes it possible to save from approx. 20 to 25 % of the time when connecting (see picture on page 13/7).
- The ASIsafe electric component is integrated for the versions with the AS-Interface connection (see on-line); an additional adapter is not required.

Application

With the standard position switches, mechanical positions of moved machine parts are converted into electrical signals. Through their modular and uniform design and large number of versions, the devices can meet practically all requirements in industry.

Devices are available with enclosure versions to suit the particular ambient conditions. Different control tasks can be performed with the best contact blocks suited for the particular purpose. And many different actuator versions are available to match the mechanical configuration of the moved machined parts. Dimensions, fixing points and characteristics are largely in accordance with the EN 50041 or EN 50047 standards.

The devices are suitable for use in any climate.

Standards

IEC 60947-5-1 or EN 60947-5-1.

The protective measure of "total insulation" by the molded-plastic enclosure is guaranteed by the use of molded-plastic screw-glands.

Safety position switches

For controls according to IEC 60204-1 or EN 60204-1 the devices can be used as a safety position switch. To secure position switches against changes in their position, keyed techniques must be employed on installation.

Safety circuits

IEC 60947-5-1 and EN 60947-5-1 require positive opening of the NC contacts, i.e. for the purposes of personal safety, the assured opening of NC contacts is expressly stipulated for the electrical equipment of machines in all safety circuits and marked according to the IEC standard 60947-5-1 with the symbol q .

Category 2 according to ISO 13849-1 (EN 954-1) can be attained with 3SE5 position switches with q , and category 3 or 4 when using an additional position switch, if the corresponding failsafe evaluation units are selected and correctly installed, e.g. the 3TK28 safety relays or matching devices from the ASIsafe, SIMATIC or SINUMERIK product ranges. The operating mechanisms (actuators) must also be connected to the enclosure by keyed techniques. The corresponding operating mechanisms are marked in the catalog with q .

Contacts for each application

- Snap-action contacts: NC and NO contacts switch simultaneously – regardless of the actuating speed ($v_{\min} = 0.01$ m/s) and contact erosion.
- Slow-action contacts: Difference in travel between "NC contact opens" and "NO contact closes"; the switching speed is the same as or proportional to the actuating speed ($v_{\min} = 0.4$ m/s).
- Slow-action contacts with make-before-break: e.g. suitable for adding a second function to a sequence control.

Operating mechanisms for each application

Standard, rounded and roller plungers

- Operation in direction of the plunger axis or in case of roller plunger with bar at right angles to the plunger axis
- The roller plunger is recommended for lateral actuation and relatively long overtravel.

Roller and angular roller levers

- For actuators made of finely ground steel in the form of cams, straight-edges (approach angle 30°) or cam disks

Spring rod

- Can be used for undefined actuations and changing starting conditions
- Starting from any direction is possible

Twist levers and rod actuators

- For a high starting speed ($v = 1.5$ m/s)
- Variety of starting options
- Insensitive to oil, grinding dust and coarse-grained material
- Adjustment of the lever in increments of 10°.
- Can be adjusted with left or right switching

Fork lever

- Switchable in two directions
- Latching actuator
- For reciprocating movements

Limit Switches

SIRIUS 3SE5 International Limit Switches

General Data

1
2
3
4
5
6
7
8
9
10
11
12
13

Options

On the following pages you will find selection tables for complete units as well as components of the modular system.

- Complete units
- Modular system

The difference between units is indicated in the selection and ordering data by gray backgrounds.

Using the modular system you can assemble switch variants which are not available as complete units. Each complete unit can also be supplied as a module.

A basic switch for the modular system comprises an enclosure with a contact block and a cover. Among the basic switches the following versions, for example, can be selected:

- Basic enclosure with teflon plunger
- Version with increased corrosion protection
- Version with 2 LEDs

- Version with M12 connector socket or 6-pole + PE
- Version with M12 connector socket and with 2 LEDs

For the plastic enclosures with a width of 31 and 50 mm the basic switches are designed as complete units with rounded plunger (according to standard).

Online configurator

The online configurator helps you not only to select and order the right position switch but also to create complete product documentation.

- Product data sheets
- Dimensional drawings
- Operating travel diagrams
- CAD data in 2D and 3D model images
- Ordering data
- Product photos

www.siemens.com/sirius/configurators

Complete units

Ordering example

Required:

- Position switch according to EN 50047 in a plastic enclosure
- Contact block with slow-action contacts 1 NO + 1 NC
- Angular roller lever, metal lever and plastic roller

To be ordered:

Version	Complete units <input type="checkbox"/>
Order No.	
Complete units • Enclosure width 31 mm	
 <p>Angular roller levers With metal lever and plastic roller 13 mm Slow-action contacts 1 NO + 1 NC</p>	3SE5 232-0BF10

Modular system

Ordering example 1

Required:



- Position switch according to EN 50047 in a plastic enclosure
- Contact block with slow-action contacts 1 NO + 1 NC
- Angular roller lever, metal lever and plastic roller

Ordering example 2



Required:

- Position switch according to EN 50047 in a plastic enclosure
- Contact block with slow-action contacts 1 NO + 1 NC
- Twist lever, high-grade steel lever and plastic roller

To be ordered separately:

Version	Modular system <input checked="" type="checkbox"/>
Order No.	
Basic switches • Enclosure width 31 mm	
 <p>With teflon plunger Slow-action contacts 1 NO + 1 NC</p>	3SE5 232-0BC05
+	
Operating mechanisms	
 <p>Angular roller levers Metal lever, plastic roller</p>	3SE5 000-0AF10

To be ordered separately:

Version	Modular system <input checked="" type="checkbox"/>
Order No.	
Basic switches • Enclosure width 31 mm	
 <p>With teflon plunger Slow-action contacts 1 NO + 1 NC</p>	3SE5 232-0BC05
+	
Twist actuators	
 <p>Twist actuators</p>	3SE5 000-0AK00
 <p>Twist levers High-grade steel lever, plastic roller</p>	3SE5 000-0AA31

Limit Switches

SIRIUS 3SE5 International Limit Switches

3SE5, plastic enclosures
Enclosure width 31 mm acc. to EN 50047





Selection and ordering data

Complete units

2 or 3 contacts · Degree of protection IP65 · Cable entry M20 × 1.5¹⁾

Version	Contacts	LEDs	DT	Complete units	Configurator	Order No.	Price per PU	PU (UNIT, SET, M)	PS*

Complete units²⁾ · Enclosure width 31 mm

Complete units ²⁾ · Enclosure width 31 mm									
Rounded plungers, type B, acc. to EN 50047									
	With teflon plunger								
	Slow-action contacts	1 NO + 1 NC	—	⊕	A	3SE5 232-0BC05		1	1 unit
	Snap-action contacts	1 NO + 1 NC	—	⊕	B	3SE5 232-0CC05		1	1 unit
	Snap-action contacts, integrated ³⁾	1 NO + 1 NC	—	⊕	A	3SE5 232-0HC05		1	1 unit
	Snap-action contacts • Short stroke, integrated ³⁾	1 NO + 1 NC	—	⊕	B	3SE5 232-0FC05		1	1 unit
	Snap-action contacts • 2 × 2 mm contact gap	1 NO + 1 NC	—	⊕	B	3SE5 232-0GC05		1	1 unit
	Slow-action contacts	1 NO + 2 NC	—	⊕	A	3SE5 232-0KC05		1	1 unit
	Snap-action contacts	1 NO + 2 NC	—	⊕	A	3SE5 232-0LC05		1	1 unit
	Slow-action contacts with make-before-break	1 NO + 2 NC	—	⊕	▶	3SE5 232-0MC05		1	1 unit
	Slow-action contacts	2 NO + 1 NC	—	⊕	A	3SE5 232-0PC05		1	1 unit
	With increased corrosion protection								
	Slow-action contacts	1 NO + 1 NC	—	⊕	B	3SE5 232-0BC05-1CA0		1	1 unit
	Snap-action contacts	1 NO + 1 NC	—	⊕	B	3SE5 232-0CC05-1CA0		1	1 unit
	Slow-action contacts	1 NO + 2 NC	—	⊕	B	3SE5 232-0KC05-1CA0		1	1 unit
	Snap-action contacts	1 NO + 2 NC	—	⊕	B	3SE5 232-0LC05-1CA0		1	1 unit
	Slow-action contacts with make-before-break	1 NO + 2 NC	—	⊕	B	3SE5 232-0MC05-1CA0		1	1 unit
	Slow-action contacts	2 NO + 1 NC	—	⊕	B	3SE5 232-0PC05-1CA0		1	1 unit
	With M12 connector socket, 4-pole (250 V, 4 A)								
	Slow-action contacts	1 NO + 1 NC	—	⊕	B	3SE5 234-0BC05-1AC4		1	1 unit
	Snap-action contacts, integrated ³⁾	1 NO + 1 NC	—	⊕	A	3SE5 234-0HC05-1AC4		1	1 unit
	Slow-action contacts	2 NC	—	⊕	B	3SE5 234-0KC05-1AE0		1	1 unit
	Snap-action contacts	2 NC	—	⊕	A	3SE5 234-0LC05-1AE0		1	1 unit
	With 2 LEDs, yellow/green								
	Slow-action contacts	1 NO + 2 NC	24 V DC	⊕	B	3SE5 232-1KC05		1	1 unit
	Snap-action contacts	1 NO + 2 NC	24 V DC	⊕	B	3SE5 232-1LC05		1	1 unit
	Slow-action contacts	1 NO + 2 NC	230 V AC	⊕	B	3SE5 232-3KC05		1	1 unit
	Snap-action contacts	1 NO + 2 NC	230 V AC	⊕	B	3SE5 232-3LC05		1	1 unit
	With M12 connector socket, 5-pole (125 V, 4 A) and 2 LEDs								
Slow-action contacts	1 NO + 1 NC	24 V DC	⊕	B	3SE5 234-1BC05-1AF3		1	1 unit	
Snap-action contacts	1 NO + 1 NC	24 V DC	⊕	B	3SE5 234-1CC05-1AF3		1	1 unit	

For online configurator see www.siemens.com/sirius/configurators.

Positive opening according to IEC 60947-5-1, Appendix K.

¹⁾ A cable gland with seal must be used with the quick-connect method.

²⁾ Popular versions.

³⁾ Subsequent replacement of contact blocks is not possible.

Limit Switches



SIRIUS 3SE5 International Limit Switches

3SE5, plastic enclosures
Enclosure width 31 mm acc. to EN 50047

2 or 3 contacts · Degree of protection IP65 · Cable entry M20 × 1.5¹⁾

Version	Contacts	LEDs	DT	Complete units	<input type="checkbox"/>	PU (UNIT, SET, M)	PS*
				Configurator			
				Order No.		Price per PU	

Complete units²⁾ · Enclosure width 31 mm

	Roller plungers, type C acc. to EN 50047						
	With plastic roller 10 mm						
	Slow-action contacts	1 NO + 1 NC	—	⊕ B	3SE5 232-0BD03	1	1 unit
	Snap-action contacts • Integrated ³⁾	1 NO + 1 NC	—	⊕ A	3SE5 232-0HD03	1	1 unit
	Snap-action contacts • Short stroke, integrated ³⁾	1 NO + 1 NC	—	⊕ B	3SE5 232-0FD03	1	1 unit
	Slow-action contacts	1 NO + 2 NC	—	⊕ B	3SE5 232-0KD03	1	1 unit
Snap-action contacts	1 NO + 2 NC	—	⊕ ▶	3SE5 232-0LD03	1	1 unit	
Actuator head rotated by 90°							
Snap-action contacts	1 NO + 2 NC	—	⊕ B	3SE5 232-0LD03-1AH0	1	1 unit	
With M12 connector socket, 4-pole (250 V, 4 A)							
Snap-action contacts, integrated ³⁾	1 NO + 1 NC	—	⊕ B	3SE5 234-0HD03-1AC4	1	1 unit	
Roller plungers with central fixing							
Snap-action contacts, integrated ³⁾	1 NO + 1 NC	—	⊕ B	3SE5 232-0HD10	1	1 unit	
Slow-action contacts	1 NO + 2 NC	—	⊕ B	3SE5 232-0KD10	1	1 unit	
	Roller levers, type E acc. to EN 50047						
	With metal lever and plastic roller 13 mm						
	Slow-action contacts	1 NO + 1 NC	—	⊕ ▶	3SE5 232-0BE10	1	1 unit
	Snap-action contacts, integrated ³⁾	1 NO + 1 NC	—	⊕ A	3SE5 232-0HE10	1	1 unit
	Slow-action contacts	1 NO + 2 NC	—	⊕ B	3SE5 232-0KE10	1	1 unit
Snap-action contacts	1 NO + 2 NC	—	⊕ B	3SE5 232-0LE10	1	1 unit	
With M12 connector socket, 4-pole (250 V, 4 A)							
Snap-action contacts, integrated ³⁾	1 NO + 1 NC	—	⊕ B	3SE5 234-0HE10-1AC4	1	1 unit	
Angular roller levers							
With metal lever and plastic roller 13 mm							
Slow-action contacts	1 NO + 1 NC	—	⊕ ▶	3SE5 232-0BF10	1	1 unit	
Snap-action contacts, integrated ³⁾	1 NO + 1 NC	—	⊕ ▶	3SE5 232-0HF10	1	1 unit	
Slow-action contacts	1 NO + 2 NC	—	⊕ B	3SE5 232-0KF10	1	1 unit	
Snap-action contacts	1 NO + 2 NC	—	⊕ B	3SE5 232-0LF10	1	1 unit	
							

For online configurator see www.siemens.com/sirius/configurators.

⊕ Positive opening according to IEC 60947-5-1, Appendix K.

¹⁾ A cable gland with seal must be used with the quick-connect method.

²⁾ Popular versions.

³⁾ Subsequent replacement of contact blocks is not possible.

Limit Switches

SIRIUS 3SE5 International Limit Switches

3SE5, plastic enclosures
Enclosure width 31 mm acc. to EN 50047

2 or 3 contacts · Degree of protection IP65 · Cable entry M20 × 1.5¹⁾

Version	Contacts	LEDs	DT	Complete units	<input type="checkbox"/>	PU (UNIT, SET, M)	PS*
				Configurator			
				Order No.	Price per PU		

Complete units²⁾ · Enclosure width 31 mm



Spring rod

Spring rods

Length 142.5 mm, with plastic plunger 50 mm

Snap-action contacts, integrated³⁾ 1 NO + 1 NC —

With M12 connector socket, 4-pole (250 V, 4 A)

Snap-action contacts, integrated³⁾ 1 NO + 1 NC —

Twist levers, type A acc. to EN 50047

With metal lever 21 mm and plastic roller 19 mm

Slow-action contacts 1 NO + 1 NC —

Snap-action contacts, integrated³⁾ 1 NO + 1 NC —

Slow-action contacts 1 NO + 2 NC —

Snap-action contacts 1 NO + 2 NC —

With M12 connector socket, 4-pole (250 V, 4 A)

Snap-action contacts, integrated³⁾ 1 NO + 1 NC —

With metal lever 35 mm and plastic roller 19 mm

Snap-action contacts, integrated³⁾ 1 NO + 1 NC —



Twist lever

Twist levers, adjustable length

With metal lever with grid hole and plastic roller 19 mm

Snap-action contacts, integrated³⁾ 1 NO + 1 NC —

With metal lever and plastic roller 19 mm

Slow-action contacts 1 NO + 1 NC —

Snap-action contacts, integrated³⁾ 1 NO + 1 NC —

Snap-action contacts 1 NO + 2 NC —

With M12 connector socket, 4-pole (250 V, 4 A)

Snap-action contacts, integrated³⁾ 1 NO + 1 NC —



Twist lever, adjustable length

Rod actuators

With aluminum rod, length 200 mm

Snap-action contacts, integrated³⁾ 1 NO + 1 NC —

With plastic rod, length 200 mm

Snap-action contacts, integrated³⁾ 1 NO + 1 NC —

With M12 connector socket, 4-pole (250 V, 4 A)

Snap-action contacts, integrated³⁾ 1 NO + 1 NC —



Rod actuator

For online configurator see www.siemens.com/sirius/configurators.

Positive opening according to IEC 60947-5-1, Appendix K.

¹⁾ A cable gland with seal must be used with the quick-connect method.

²⁾ Popular versions.

³⁾ Subsequent replacement of contact blocks is not possible.

Note:

If the device you require is not available as a complete unit, see "Modular System", page 13/13.

Limit Switches

SIRIUS 3SE5 International Limit Switches

3SE5, plastic enclosures
Enclosure width 31 mm acc. to EN 50047





1
2
3
4
5
6
7
8
9
10
11
12
13

Modular system

2 or 3 contacts · Degree of protection IP65 · Cable entry M20 × 1.5¹⁾

Version	Contacts	LEDs	DT	Modular system		PU (UNIT, SET, M)	PS*
				Configurator			
				Order No.	Price per PU		

Basic switches · Enclosure width 31 mm (with rounded plunger²⁾)

 Basic switch	With teflon plunger						
	Slow-action contacts	1 NO + 1 NC	—	⊕ A	3SE5 232-0BC05	1	1 unit
	Snap-action contacts	1 NO + 1 NC	—	⊕ ▶	3SE5 232-0CC05	1	1 unit
	Snap-action contacts, integrated ³⁾	1 NO + 1 NC	—	⊕ ▶	3SE5 232-0HC05	1	1 unit
	Snap-action contacts • Short stroke, integrated ³⁾	1 NO + 1 NC	—	⊕ B	3SE5 232-0FC05	1	1 unit
	Snap-action contacts • 2 × 2 mm contact gap	1 NO + 1 NC	—	⊕ B	3SE5 232-0GC05	1	1 unit
	Slow-action contacts	1 NO + 2 NC	—	⊕ A	3SE5 232-0KC05	1	1 unit
	Snap-action contacts	1 NO + 2 NC	—	⊕ ▶	3SE5 232-0LC05	1	1 unit
	Slow-action contacts with make-before-break	1 NO + 2 NC	—	⊕ A	3SE5 232-0MC05	1	1 unit
Slow-action contacts	2 NO + 1 NC	—	⊕ A	3SE5 232-0PC05	1	1 unit	
 With increased corrosion protection	With increased corrosion protection⁴⁾						
	Slow-action contacts	1 NO + 1 NC	—	⊕ B	3SE5 232-0BC05-1CA0	1	1 unit
	Snap-action contacts	1 NO + 1 NC	—	⊕ B	3SE5 232-0CC05-1CA0	1	1 unit
	Slow-action contacts	1 NO + 2 NC	—	⊕ B	3SE5 232-0KC05-1CA0	1	1 unit
	Snap-action contacts	1 NO + 2 NC	—	⊕ B	3SE5 232-0LC05-1CA0	1	1 unit
	Slow-action contacts with make-before-break	1 NO + 2 NC	—	⊕ B	3SE5 232-0MC05-1CA0	1	1 unit
Slow-action contacts	2 NO + 1 NC	—	⊕ B	3SE5 232-0PC05-1CA0	1	1 unit	
 With M12 socket	With M12 connector socket, 4-pole (250 V, 4 A)						
	Slow-action contacts	1 NO + 1 NC	—	⊕ B	3SE5 234-0BC05-1AC4	1	1 unit
	Snap-action contacts, integrated ³⁾	1 NO + 1 NC	—	⊕ A	3SE5 234-0HC05-1AC4	1	1 unit
	Slow-action contacts	2 NC	—	⊕ B	3SE5 234-0KC05-1AE0	1	1 unit
Snap-action contacts	2 NC	—	⊕ A	3SE5 234-0LC05-1AE0	1	1 unit	
 With 2 LEDs	With 2 LEDs, yellow/green						
	Slow-action contacts	1 NO + 2 NC	24 V DC	⊕ B	3SE5 232-1KC05	1	1 unit
	Snap-action contacts	1 NO + 2 NC	24 V DC	⊕ B	3SE5 232-1LC05	1	1 unit
	Slow-action contacts	1 NO + 2 NC	230 V AC	⊕ B	3SE5 232-3KC05	1	1 unit
Snap-action contacts	1 NO + 2 NC	230 V AC	⊕ B	3SE5 232-3LC05	1	1 unit	
 With M12 socket and 2 LEDs	With M12 connector socket, 5-pole (125 V, 4 A) and 2 LEDs						
	Slow-action contacts	1 NO + 1 NC	24 V DC	⊕ B	3SE5 234-1BC05-1AF3	1	1 unit
Snap-action contacts	1 NO + 1 NC	24 V DC	⊕ B	3SE5 234-1CC05-1AF3	1	1 unit	

For online configurator see www.siemens.com/sirius/configurators .

⊕ Positive opening according to IEC 60947-5-1, Appendix K, or positively driven actuator, necessary in safety circuits.

¹⁾ A cable gland with seal must be used with the quick-connect method.

²⁾ For enclosures with widths of 31mm, the basic switch is a complete unit with rounded plungers.

³⁾ Subsequent replacement of contact blocks is not possible.

⁴⁾ Use corresponding high-grade steel lever.











Note:

Selection aid [see page 13/9](#).

Limit Switches

SIRIUS 3SE5 International Limit Switches

3SE5, plastic enclosures
Enclosure width 31 mm acc. to EN 50047

Version	Diameter	DT	Modular system	Price per PU	PU (UNIT, SET, M)	PS*	
	mm		Order No.				
Operating mechanisms							
 Roller plunger	Roller plungers, type C acc. to EN 50047						
	Plastic rollers	10	➔ ▶	3SE5 000-0AD03	1	1 unit	
	High-grade steel rollers	10	➔ B	3SE5 000-0AD04	1	1 unit	
 With central fixing	Roller plungers with central fixing						
	Plastic rollers	10	➔ B	3SE5 000-0AD10	1	1 unit	
	High-grade steel rollers	10	➔ B	3SE5 000-0AD11	1	1 unit	
 Roller lever	Roller levers, type E acc. to EN 50047						
	Metal lever, plastic roller	13	➔ ▶	3SE5 000-0AE10	1	1 unit	
	Metal lever, high-grade steel roller	13	➔ ▶	3SE5 000-0AE11	1	1 unit	
	High-grade steel lever, plastic roller	13	➔ B	3SE5 000-0AE12	1	1 unit	
	High-grade steel lever, high-grade steel roller	13	➔ B	3SE5 000-0AE13	1	1 unit	
 Angular roller lever	Angular roller levers						
	Metal lever, plastic roller	13	➔ ▶	3SE5 000-0AF10	1	1 unit	
	Metal lever, high-grade steel roller	13	➔ B	3SE5 000-0AF11	1	1 unit	
	High-grade steel lever, plastic roller	13	➔ A	3SE5 000-0AF12	1	1 unit	
	High-grade steel lever, high-grade steel roller	13	➔ B	3SE5 000-0AF13	1	1 unit	
 Spring rod	Spring rods (for switches with snap-action contacts only)						
	Plastic plunger and high-grade steel spring:	7					
	• Length 142.5 mm (spring 50 mm, plunger 50 mm)		▶	3SE5 000-0AR01	1	1 unit	
	• Length 76 mm (spring 23.5 mm, plunger 10 mm)		▶	3SE5 000-0AR03	1	1 unit	
	• Length 242.5 mm (spring 150 mm, plunger 50 mm)		B	3SE5 000-0AR04	1	1 unit	
	High-grade steel plunger and spring:	7					
• Length 142.5 mm (spring 50 mm, plunger 50 mm)		B	3SE5 000-0AR02	1	1 unit		
Twist actuators							
 Twist actuator	Twist actuators, plastic (without lever)						
	Switching right and/or left, adjustable		➔ ▶	3SE5 000-0AK00	1	1 unit	
Levers for twist actuators							
 Twist lever	Twist levers 21 mm, straight, type A acc. to EN 50047						
	Metal lever, plastic roller	19	➔ ▶	3SE5 000-0AA21	1	1 unit	
	Metal lever, high-grade steel roller	19	➔ B	3SE5 000-0AA22	1	1 unit	
	Metal lever, roller with ball bearing	19	➔ B	3SE5 000-0AA23	1	1 unit	
	Metal lever, plastic roller	30	➔ B	3SE5 000-0AA25	1	1 unit	
	High-grade steel lever, plastic roller	19	➔ B	3SE5 000-0AA31	1	1 unit	
	High-grade steel lever, high-grade steel roller	19	➔ B	3SE5 000-0AA32	1	1 unit	
 Twist levers 30 mm, straight ¹⁾	Metal lever, plastic roller		19	➔ B	3SE5 000-0AA24	1	1 unit
	Twist levers, adjustable length, with grid hole						
 Twist lever, adjustable length	Metal lever, plastic roller	19	➔ ▶	3SE5 000-0AA60	1	1 unit	
	Metal lever, high-grade steel roller	19	➔ ▶	3SE5 000-0AA61	1	1 unit	
	Metal lever, plastic roller	50	➔ B	3SE5 000-0AA67	1	1 unit	
	Metal lever, rubber roller	50	➔ B	3SE5 000-0AA68	1	1 unit	
	High-grade steel lever, plastic roller	19	➔ B	3SE5 000-0AA62	1	1 unit	
	High-grade steel lever, high-grade steel roller	19	➔ B	3SE5 000-0AA63	1	1 unit	
 Rod actuator	Twist levers, adjustable length						
	Metal lever, plastic roller	19	A	3SE5 000-0AA50	1	1 unit	
	Metal lever, high-grade steel roller	19	B	3SE5 000-0AA51	1	1 unit	
	Metal lever, plastic roller	30	B	3SE5 000-0AA55	1	1 unit	
	Metal lever, plastic roller	50	B	3SE5 000-0AA57	1	1 unit	
	Metal lever, rubber roller	50	B	3SE5 000-0AA58	1	1 unit	
	High-grade steel lever, plastic roller	19	B	3SE5 000-0AA52	1	1 unit	
	High-grade steel lever, high-grade steel roller	19	B	3SE5 000-0AA53	1	1 unit	
Rod actuators							
Aluminum rod, length 200 mm	6	▶	3SE5 000-0AA80	1	1 unit		
Spring rod, length 200 mm	6	B	3SE5 000-0AA81	1	1 unit		
Plastic rod, length 200 mm	6	▶	3SE5 000-0AA82	1	1 unit		

➔ Positively driven actuator, necessary in safety circuits.

¹⁾ Can be clinch mounted (turned through 180°, rear of lever).

Limit Switches

SIRIUS 3SE5 International Limit Switches

3SE5, plastic enclosures
Enclosure width 40 mm acc. to EN 50041

Selection and ordering data

Complete units

2 or 3 contacts · Degree of protection IP66/67 · Cable entry M20 × 1.5

Version	Contacts	LEDs	DT	Complete units	<input type="checkbox"/>	PU (UNIT, SET, M)	PS*
				Configurator			
				Order No.		Price per PU	

Complete units¹⁾ · Enclosure width 40 mm

	Plain plungers						
	With high-grade steel plunger						
	Slow-action contacts	1 NO + 1 NC	—	⊕ B	3SE5 132-0BB01	1	1 unit
	Snap-action contacts	1 NO + 1 NC	—	⊕ B	3SE5 132-0CB01	1	1 unit
	Slow-action contacts	1 NO + 2 NC	—	⊕ B	3SE5 132-0KB01	1	1 unit
	Snap-action contacts	1 NO + 2 NC	—	⊕ B	3SE5 132-0LB01	1	1 unit
	Slow-action contacts	2 NO + 1 NC	—	⊕ B	3SE5 132-0PB01	1	1 unit
	Rounded plungers, type B acc. to EN 50041						
	With plastic plunger						
	Slow-action contacts	1 NO + 1 NC	—	⊕ A	3SE5 132-0BC03	1	1 unit
	Snap-action contacts	1 NO + 1 NC	—	⊕ A	3SE5 132-0CC03	1	1 unit
	Slow-action contacts	1 NO + 2 NC	—	⊕ B	3SE5 132-0KC03	1	1 unit
	Snap-action contacts	1 NO + 2 NC	—	⊕ B	3SE5 132-0LC03	1	1 unit
	Slow-action contacts	2 NO + 1 NC	—	⊕ B	3SE5 132-0PC03	1	1 unit
	Roller plungers, type C acc. to EN 50041						
	With plastic roller 13 mm						
	Slow-action contacts	1 NO + 1 NC	—	⊕ B	3SE5 132-0BD05	1	1 unit
	Snap-action contacts	1 NO + 1 NC	—	⊕ A	3SE5 132-0CD05	1	1 unit
	Slow-action contacts	1 NO + 2 NC	—	⊕ B	3SE5 132-0KD05	1	1 unit
	Snap-action contacts	1 NO + 2 NC	—	⊕ B	3SE5 132-0LD05	1	1 unit
	Slow-action contacts	2 NO + 1 NC	—	⊕ B	3SE5 132-0PD05	1	1 unit
	Roller levers						
	With metal lever and plastic roller 22 mm						
	Slow-action contacts	1 NO + 1 NC	—	⊕ B	3SE5 132-0BE05	1	1 unit
	Snap-action contacts	1 NO + 1 NC	—	⊕ A	3SE5 132-0CE05	1	1 unit
	Slow-action contacts	1 NO + 2 NC	—	⊕ B	3SE5 132-0KE05	1	1 unit
	Snap-action contacts	1 NO + 2 NC	—	⊕ B	3SE5 132-0LE05	1	1 unit
	Slow-action contacts	2 NO + 1 NC	—	⊕ B	3SE5 132-0PE05	1	1 unit
	Angular roller levers						
	With metal lever and plastic roller 22 mm						
	Slow-action contacts	1 NO + 1 NC	—	⊕ B	3SE5 132-0BF05	1	1 unit
	Snap-action contacts	1 NO + 1 NC	—	⊕ B	3SE5 132-0CF05	1	1 unit
	Snap-action contacts	1 NO + 2 NC	—	⊕ B	3SE5 132-0LF05	1	1 unit
	Spring rods						
	Length 142.5 mm, with plastic plunger 50 mm						
	Snap-action contacts	1 NO + 1 NC	—	B	3SE5 132-0CR01	1	1 unit
	Snap-action contacts	1 NO + 2 NC	—	B	3SE5 132-0LR01	1	1 unit

For online configurator see www.siemens.com/sirius/configurators.

⊕ Positive opening according to IEC 60947-5-1, Appendix K.

¹⁾ Popular versions.

Limit Switches

SIRIUS 3SE5 International Limit Switches

3SE5, plastic enclosures
Enclosure width 40 mm acc. to EN 50041

2 or 3 contacts · Degree of protection IP66/IP67 · Cable entry M20 × 1.5

Version	Contacts	LEDs	DT	Complete units	<input type="checkbox"/>	PU (UNIT, SET, M)	PS*
				Configurator			
				Order No.		Price per PU	

Complete units¹⁾ · Enclosure width 40 mm



Twist lever

Twist levers, type A acc. to EN 50041

With metal lever 27 mm and plastic roller 19 mm

Slow-action contacts	1 NO + 1 NC	—		A	3SE5 132-0BJ01	1	1 unit
Snap-action contacts	1 NO + 1 NC	—		▶	3SE5 132-0CJ01	1	1 unit
Slow-action contacts	1 NO + 2 NC	—		B	3SE5 132-0KJ01	1	1 unit
Snap-action contacts	1 NO + 2 NC	—		B	3SE5 132-0LJ01	1	1 unit
Slow-action contacts	2 NO + 1 NC	—		B	3SE5 132-0PJ01	1	1 unit



Twist lever, adjustable length, with grid hole

Twist levers, adjustable length

With metal lever with grid hole and plastic roller 19 mm

Snap-action contacts	1 NO + 1 NC	—		B	3SE5 132-0CJ60	1	1 unit
Snap-action contacts	1 NO + 2 NC	—		B	3SE5 132-0LJ60	1	1 unit



Twist lever, adjustable length

With metal lever and plastic roller 19 mm

Snap-action contacts	1 NO + 1 NC	—		A	3SE5 132-0CJ50	1	1 unit
Snap-action contacts	1 NO + 2 NC	—		B	3SE5 132-0LJ50	1	1 unit



Rod actuator

Rod actuators, type D, acc. to EN 50041

With aluminum rod, length 200 mm

Snap-action contacts	1 NO + 1 NC	—		B	3SE5 132-0CJ80	1	1 unit
----------------------	-------------	---	--	---	-----------------------	---	--------

With plastic rod, length 200 mm

Snap-action contacts	1 NO + 1 NC	—		A	3SE5 132-0CJ82	1	1 unit
----------------------	-------------	---	--	---	-----------------------	---	--------

For online configurator see www.siemens.com/sirius/configurators.

Positive opening according to IEC 60947-5-1, Appendix K.

¹⁾ Popular versions.

Note:

If the device you require is not available as a complete unit, see "Modular System", page 13/17.



Limit Switches

SIRIUS 3SE5 International Limit Switches





3SE5, plastic enclosures
Enclosure width 40 mm acc. to EN 50041

Modular system

2 or 3 contacts · Degree of protection IP66/IP67 · Cable entry M20 × 1.5

Version	Contacts	LEDs	DT	Modular system	PU (UNIT, SET, M)	PS*
						
						
				Order No.	Price per PU	

Basic switches · Enclosure width 40 mm

	With M20 × 1.5 connecting thread						
	Slow-action contacts	1 NO + 1 NC	—	⊕ B	3SE5 132-0BA00	1	1 unit
	Snap-action contacts	1 NO + 1 NC	—	⊕ A	3SE5 132-0CA00	1	1 unit
	• Gold-plated contacts			⊕ B	3SE5 132-0CA00-1AC1	1	1 unit
	Slow-action contacts	1 NO + 2 NC	—	⊕ B	3SE5 132-0KA00	1	1 unit
	Snap-action contacts	1 NO + 2 NC	—	⊕ B	3SE5 132-0LA00	1	1 unit
	Slow-action contacts with make-before-break	1 NO + 2 NC	—	⊕ B	3SE5 132-0MA00	1	1 unit
Slow-action contacts	2 NO + 1 NC	—	⊕ B	3SE5 132-0PA00	1	1 unit	
	With increased corrosion protection¹⁾						
	Slow-action contacts	1 NO + 1 NC	—	⊕ B	3SE5 132-0BA00-1CA0	1	1 unit
	Snap-action contacts	1 NO + 1 NC	—	⊕ B	3SE5 132-0CA00-1CA0	1	1 unit
	Slow-action contacts	1 NO + 2 NC	—	⊕ B	3SE5 132-0KA00-1CA0	1	1 unit
	Snap-action contacts	1 NO + 2 NC	—	⊕ B	3SE5 132-0LA00-1CA0	1	1 unit
	Slow-action contacts with make-before-break	1 NO + 2 NC	—	⊕ B	3SE5 132-0MA00-1CA0	1	1 unit
	Slow-action contacts	2 NO + 1 NC	—	⊕ B	3SE5 132-0PA00-1CA0	1	1 unit
	With M12 connector socket, 4-pole (250 V, 4 A)						
	Slow-action contacts	1 NO + 1 NC	—	⊕ B	3SE5 134-0BA00-1AC4	1	1 unit
	Snap-action contacts	1 NO + 1 NC	—	⊕ B	3SE5 134-0CA00-1AC4	1	1 unit
	Slow-action contacts	2 NC	—	⊕ B	3SE5 134-0KA00-1AE0	1	1 unit
	Snap-action contacts	2 NC	—	⊕ B	3SE5 134-0LA00-1AE0	1	1 unit
	With 2 LEDs, yellow/green						
	Slow-action contacts	1 NO + 2 NC	24 V DC	⊕ C	3SE5 132-1KA00	1	1 unit
	Snap-action contacts	1 NO + 2 NC	24 V DC	⊕ C	3SE5 132-1LA00	1	1 unit
	Slow-action contacts	1 NO + 2 NC	230 V AC	⊕ C	3SE5 132-3KA00	1	1 unit
	Snap-action contacts	1 NO + 2 NC	230 V AC	⊕ C	3SE5 132-3LA00	1	1 unit

 For online configurator see www.siemens.com/sirius/configurators.

 Positive opening according to IEC 60947-5-1, Appendix K, or positively driven actuator, necessary in safety circuits.

¹⁾ Use corresponding high-grade steel lever.













Note:

Selection aid [see page 13/9](#).

Limit Switches

SIRIUS 3SE5 International Limit Switches

3SE5, plastic enclosures
Enclosure width 40 mm acc. to EN 50041

Version	Diameter	DT	Modular system	Price per PU	PU (UNIT, SET, M)	PS*
	mm		Order No.			
Operating mechanisms						
	Plain plungers High-grade steel plungers	10	⊕ A	3SE5 000-0AB01	1	1 unit
Plain plunger						
	Rounded plungers, type B acc. to EN 50041 Plastic plungers	10	⊕ B	3SE5 000-0AC03	1	1 unit
Plunger						
	Roller plungers, type C acc. to EN 50041 Plastic plunger, plastic roller Plastic plunger, high-grade steel roller	13 13	⊕ B ⊕ B	3SE5 000-0AD05 3SE5 000-0AD06	1 1	1 unit 1 unit
Plunger						
	Roller levers Metal lever with plastic roller, plastic base	22	⊕ B	3SE5 000-0AE05	1	1 unit
Roller lever						
	Angular roller levers Metal lever with plastic roller, plastic base	22	⊕ B	3SE5 000-0AF05	1	1 unit
Angular roller lever						
	Spring rods (for switches with snap-action contacts only) Plastic plunger and high-grade steel spring: • Length 142.5 mm (spring 50 mm, plunger 50 mm) • Length 76 mm (spring 23.5 mm, plunger 10 mm) • Length 242.5 mm (spring 150 mm, plunger 50 mm) High-grade steel plunger and spring: • Length 142.5 mm (spring 50 mm, plunger 50 mm)	7 7	B B B B	3SE5 000-0AR01 3SE5 000-0AR03 3SE5 000-0AR04 3SE5 000-0AR02	1 1 1 1	1 unit 1 unit 1 unit 1 unit
Spring rod						
Twist actuators						
	Twist actuators, plastic (without lever) • For twist levers and rod actuators, switching right and/or left, adjustable		⊕ B	3SE5 000-0AJ00	1	1 unit
Twist actuator						
	Levers for twist actuators Twist levers, offset, type A acc. to EN 50041 Metal lever 27 mm, plastic roller Metal lever 27 mm, high-grade steel roller Metal lever 27 mm, roller with ball bearing Metal lever 27 mm, 2 plastic rollers Metal lever 27 mm, plastic roller Metal lever 27 mm, rubber roller High-grade steel lever 27 mm, plastic roller High-grade steel lever 27 mm, high-grade steel roller Metal lever 35 mm, plastic roller	19 19 19 19 30 50 19 19 19	⊕ ▶ ⊕ ▶ ⊕ B ⊕ ▶ ⊕ B ⊕ ▶ ⊕ B ⊕ ▶ ⊕ B	3SE5 000-0AA01 3SE5 000-0AA02 3SE5 000-0AA03 3SE5 000-0AA04 3SE5 000-0AA05 3SE5 000-0AA08 3SE5 000-0AA11 3SE5 000-0AA12 3SE5 000-0AA15	1 1 1 1 1 1 1 1 1	1 unit 1 unit 1 unit 1 unit 1 unit 1 unit 1 unit 1 unit 1 unit
Twist lever						
	Twist levers 30 mm, straight¹⁾ Metal lever, plastic roller Metal lever, plastic roller	19 30	⊕ B ⊕ B	3SE5 000-0AA24 3SE5 000-0AA26	1 1	1 unit 1 unit
Twist lever, adjustable length						
	Twist levers, adjustable length, with grid hole Metal lever, plastic roller Metal lever, high-grade steel roller Metal lever, rubber roller High-grade steel lever, plastic roller High-grade steel lever, high-grade steel roller	19 19 50 19 19	⊕ B ⊕ B ⊕ B ⊕ B ⊕ B	3SE5 000-0AA60 3SE5 000-0AA61 3SE5 000-0AA68 3SE5 000-0AA62 3SE5 000-0AA63	1 1 1 1 1	1 unit 1 unit 1 unit 1 unit 1 unit
Twist lever, adjustable length						
	Twist levers, adjustable length Metal lever, plastic roller Metal lever, high-grade steel roller Metal lever, plastic roller Metal lever, rubber roller High-grade steel lever, plastic roller High-grade steel lever, high-grade steel roller	19 19 30 50 19 19	A B B B B B	3SE5 000-0AA50 3SE5 000-0AA51 3SE5 000-0AA55 3SE5 000-0AA58 3SE5 000-0AA52 3SE5 000-0AA53	1 1 1 1 1 1	1 unit 1 unit 1 unit 1 unit 1 unit 1 unit
Twist lever, adjustable length						
	Rod actuators, type D acc. to EN 50041 Aluminum rod, length 200 mm Spring rod, length 200 mm Plastic rod, length 200 mm	6 6 6	B B B	3SE5 000-0AA80 3SE5 000-0AA81 3SE5 000-0AA82	1 1 1	1 unit 1 unit 1 unit
Rod actuator						

⊕ Positively driven actuator, necessary in safety circuits.

¹⁾ Can be clinch mounted (turned through 180°, rear of lever).

Limit Switches

SIRIUS 3SE5 International Limit Switches

3SE5, plastic enclosures
Enclosure width 50 mm

1
2
3
4
5
6
7
8
9
10
11
12
13

Selection and ordering data

Complete units

2 or 3 contacts · Degree of protection IP66/IP67 · Cable entry 2 × (M20 × 1.5)

Version	Contacts	LEDs	DT	Complete units	PU (UNIT, SET, M)	PS*
				<input type="checkbox"/>		
				Order No.	Price per PU	

Complete units¹⁾ · Enclosure width 50 mm



Rounded plunger

Rounded plungers

With teflon plunger

Slow-action contacts	1 NO + 1 NC	—	⊙ ▶	3SE5 242-0BC05	1	1 unit
Snap-action contacts	1 NO + 1 NC	—	⊙ B	3SE5 242-0CC05	1	1 unit
Snap-action contacts, integrated ²⁾	1 NO + 1 NC	—	⊙ ▶	3SE5 242-0HC05	1	1 unit
Snap-action contacts • Short stroke, integrated ²⁾	1 NO + 1 NC	—	⊙ B	3SE5 242-0FC05	1	1 unit
Snap-action contacts • 2 × 2 mm contact gap	1 NO + 1 NC	—	⊙ B	3SE5 242-0GC05	1	1 unit
Slow-action contacts	1 NO + 2 NC	—	⊙ B	3SE5 242-0KC05	1	1 unit
Snap-action contacts	1 NO + 2 NC	—	⊙ B	3SE5 242-0LC05	1	1 unit
Slow-action contacts with make-before-break	1 NO + 2 NC	—	⊙ A	3SE5 242-0MC05	1	1 unit
Slow-action contacts	2 NO + 1 NC	—	⊙ A	3SE5 242-0PC05	1	1 unit



With increased corrosion protection

With increased corrosion protection

Slow-action contacts	1 NO + 1 NC	—	⊙ B	3SE5 242-0BC05-1CA0	1	1 unit
Snap-action contacts, integrated ²⁾	1 NO + 1 NC	—	⊙ B	3SE5 242-0HC05-1CA0	1	1 unit
Slow-action contacts	1 NO + 2 NC	—	⊙ B	3SE5 242-0KC05-1CA0	1	1 unit
Snap-action contacts	1 NO + 2 NC	—	⊙ B	3SE5 242-0LC05-1CA0	1	1 unit
Slow-action contacts with make-before-break	1 NO + 2 NC	—	⊙ B	3SE5 242-0MC05-1CA0	1	1 unit
Slow-action contacts	2 NO + 1 NC	—	⊙ B	3SE5 242-0PC05-1CA0	1	1 unit



With 2 LEDs

With 2 LEDs, yellow/green

Slow-action contacts	1 NO + 2 NC	24 V DC	⊙ B	3SE5 242-1KC05	1	1 unit
Snap-action contacts	1 NO + 2 NC	24 V DC	⊙ B	3SE5 242-1LC05	1	1 unit
Slow-action contacts	1 NO + 2 NC	230 V AC	⊙ B	3SE5 242-3KC05	1	1 unit
Snap-action contacts	1 NO + 2 NC	230 V AC	⊙ B	3SE5 242-3LC05	1	1 unit



Roller plunger

Roller plungers

With plastic roller 10 mm

Slow-action contacts	1 NO + 1 NC	—	⊙ ▶	3SE5 242-0BD03	1	1 unit
Snap-action contacts, integrated ²⁾	1 NO + 1 NC	—	⊙ ▶	3SE5 242-0HD03	1	1 unit
Snap-action contacts	1 NO + 2 NC	—	⊙ ▶	3SE5 242-0LD03	1	1 unit

For online configurator see www.siemens.com/sirius/configurators.

⊙ Positive opening according to IEC 60947-5-1, Appendix K.

¹⁾ Popular versions.

²⁾ Subsequent replacement of contact blocks is not possible.

Limit Switches

SIRIUS 3SE5 International Limit Switches

3SE5, plastic enclosures
Enclosure width 50 mm

2 or 3 contacts · Degree of protection IP66/IP67 · Cable entry 2 × (M20 × 1.5)

Version	Contacts	LEDs	DT	Complete units	<input type="checkbox"/>	PU (UNIT, SET, M)	PS*
				Configurator			
				Order No.	Price per PU		

Complete units¹⁾ · Enclosure width 50 mm



Roller lever

Roller levers

With metal lever and plastic roller 13 mm

Slow-action contacts	1 NO + 1 NC	—		B	3SE5 242-0BE10	1	1 unit
Snap-action contacts, integrated ²⁾	1 NO + 1 NC	—			3SE5 242-0HE10	1	1 unit
Snap-action contacts	1 NO + 2 NC	—		B	3SE5 242-0LE10	1	1 unit
With M12 connector socket, 4-pole right (250 V, 4 A)							
Snap-action contacts	2 NC	—		B	3SE5 244-0LE10-1AE0	1	1 unit



Twist lever

Twist levers

With metal lever 21 mm and plastic roller 19 mm

Slow-action contacts	1 NO + 1 NC	—		B	3SE5 242-0BK21	1	1 unit
Snap-action contacts, integrated ²⁾	1 NO + 1 NC	—			3SE5 242-0HK21	1	1 unit
Snap-action contacts	1 NO + 2 NC	—		B	3SE5 242-0LK21	1	1 unit

Twist levers, adjustable length

With metal lever and plastic roller 19 mm

Snap-action contacts, integrated ²⁾	1 NO + 1 NC	—		B	3SE5 242-0HK50	1	1 unit
--	-------------	---	--	---	-----------------------	---	--------

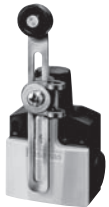

Twist lever, adjustable length

For online configurator see www.siemens.com/sirius/configurators.

Positive opening according to IEC 60947-5-1, Appendix K.

¹⁾ Popular versions.

²⁾ Subsequent replacement of contact blocks is not possible.

Note:

If the device you require is not available as a complete unit, see "Modular System", page 13/21.

Limit Switches

SIRIUS 3SE5 International Limit Switches

3SE5, plastic enclosures
Enclosure width 50 mm

1
2
3
4
5
6
7
8
9
10
11
12
13

Modular system

2 or 3 contacts · Degree of protection IP66/IP67 · Cable entry 2 × (M20 × 1.5)

Version	Contacts	LEDs	DT	Modular system	PU (UNIT, SET, M)	PS*
				Order No.	Price per PU	

Basic switches · Enclosure width 50 mm (with rounded plunger¹⁾)

	With teflon plunger					
	Slow-action contacts	1 NO + 1 NC	—	⊕ ▶	3SE5 242-0BC05	1 1 unit
	Snap-action contacts	1 NO + 1 NC	—	⊕ B	3SE5 242-0CC05	1 1 unit
	Snap-action contacts, integrated ²⁾	1 NO + 1 NC	—	⊕ ▶	3SE5 242-0HC05	1 1 unit
	Snap-action contacts • Short stroke, integrated ²⁾	1 NO + 1 NC	—	⊕ B	3SE5 242-0FC05	1 1 unit
	Snap-action contacts • 2 × 2 mm contact gap	1 NO + 1 NC	—	⊕ B	3SE5 242-0GC05	1 1 unit
	Slow-action contacts	1 NO + 2 NC	—	⊕ B	3SE5 242-0KC05	1 1 unit
	Snap-action contacts	1 NO + 2 NC	—	⊕ B	3SE5 242-0LC05	1 1 unit
	Slow-action contacts with make-before-break	1 NO + 2 NC	—	⊕ A	3SE5 242-0MC05	1 1 unit
Slow-action contacts	2 NO + 1 NC	—	⊕ A	3SE5 242-0PC05	1 1 unit	
	With increased corrosion protection³⁾					
	Slow-action contacts	1 NO + 1 NC	—	⊕ B	3SE5 242-0BC05-1CA0	1 1 unit
	Snap-action contacts, integrated ²⁾	1 NO + 1 NC	—	⊕ B	3SE5 242-0HC05-1CA0	1 1 unit
	Slow-action contacts	1 NO + 2 NC	—	⊕ B	3SE5 242-0KC05-1CA0	1 1 unit
	Snap-action contacts	1 NO + 2 NC	—	⊕ B	3SE5 242-0LC05-1CA0	1 1 unit
	Slow-action contacts with make-before-break	1 NO + 2 NC	—	⊕ B	3SE5 242-0MC05-1CA0	1 1 unit
Slow-action contacts	2 NO + 1 NC	—	⊕ B	3SE5 242-0PC05-1CA0	1 1 unit	
	With 2 LEDs, yellow/green					
	Slow-action contacts	1 NO + 2 NC	24 V DC	⊕ B	3SE5 242-1KC05	1 1 unit
	Snap-action contacts	1 NO + 2 NC	24 V DC	⊕ B	3SE5 242-1LC05	1 1 unit
	Slow-action contacts	1 NO + 2 NC	230 V AC	⊕ B	3SE5 242-3KC05	1 1 unit
	Snap-action contacts	1 NO + 2 NC	230 V AC	⊕ B	3SE5 242-3LC05	1 1 unit

For online configurator see www.siemens.com/sirius/configurators.

Positive opening according to IEC 60947-5-1, Appendix K, or positively driven actuator, necessary in safety circuits.

¹⁾ For enclosures with widths of 50 mm, the basic switch is a complete unit with rounded plungers.

²⁾ Subsequent replacement of contact blocks is not possible.

³⁾ Use corresponding high-grade steel lever.

Note:

Selection aid [see page 13/9](#).

Version	Diameter	DT	Modular system	PU (UNIT, SET, M)	PS*
	mm				
			Order No.	Price per PU	

Operating mechanisms









	Roller plungers, type C acc. to EN 50047					
	Plastic rollers	10	⊕ A	3SE5 000-0AD03	1 1 unit	
	High-grade steel rollers	10	⊕ B	3SE5 000-0AD04	1 1 unit	
	Roller plungers with central fixing					
	Plastic rollers	10	⊕ B	3SE5 000-0AD10	1 1 unit	
	High-grade steel rollers	10	⊕ B	3SE5 000-0AD11	1 1 unit	

Positively driven actuator, necessary in safety circuits.

Limit Switches

SIRIUS 3SE5 International Limit Switches

3SE5, plastic enclosures
Enclosure width 50 mm

Version	Diameter	DT	Modular system	PU (UNIT, SET, M)	PS*
	mm		Order No.	Price per PU	
Operating mechanisms					
	Roller levers, type E acc. to EN 50047				
	Metal lever, plastic roller	13	⊕ A	3SE5 000-0AE10	1 1 unit
	Metal lever, high-grade steel roller	13	⊕ B	3SE5 000-0AE11	1 1 unit
	High-grade steel lever, plastic roller	13	⊕ B	3SE5 000-0AE12	1 1 unit
	Angular roller levers				
	Metal lever, plastic roller	13	⊕ A	3SE5 000-0AF10	1 1 unit
	Metal lever, high-grade steel roller	13	⊕ B	3SE5 000-0AF11	1 1 unit
	High-grade steel lever, plastic roller	13	⊕ A	3SE5 000-0AF12	1 1 unit
	Spring rods (for switches with snap-action contacts only)				
	Plastic plunger and high-grade steel spring:	7			
	• Length 142.5 mm (spring 50 mm, plunger 50 mm)		B	3SE5 000-0AR01	1 1 unit
	• Length 76 mm (spring 23.5 mm, plunger 10 mm)		B	3SE5 000-0AR03	1 1 unit
	• Length 242.5 mm (spring 150 mm, plunger 50 mm)		B	3SE5 000-0AR04	1 1 unit
High-grade steel plunger and spring:	7				
• Length 142.5 mm (spring 50 mm, plunger 50 mm)		B	3SE5 000-0AR02	1 1 unit	
Twist actuators					
	Twist actuators, plastic (without lever)				
	Switching right and/or left, adjustable		⊕ A	3SE5 000-0AK00	1 1 unit
	Levers for twist actuators				
	Twist levers 21 mm, straight, type A acc. to EN 50047				
	Metal lever, plastic roller	19	⊕ A	3SE5 000-0AA21	1 1 unit
	Metal lever, high-grade steel roller	19	⊕ B	3SE5 000-0AA22	1 1 unit
	Metal lever, roller with ball bearing	19	⊕ B	3SE5 000-0AA23	1 1 unit
	Metal lever, plastic roller	30	⊕ B	3SE5 000-0AA25	1 1 unit
	High-grade steel lever, plastic roller	19	⊕ B	3SE5 000-0AA31	1 1 unit
High-grade steel lever, high-grade steel roller	19	⊕ B	3SE5 000-0AA32	1 1 unit	
	Twist levers 30 mm, straight¹⁾				
	Metal lever, plastic roller	19	⊕ B	3SE5 000-0AA24	1 1 unit
	Metal lever, plastic roller	30	⊕ B	3SE5 000-0AA26	1 1 unit
	Twist levers, adjustable length, with grid hole				
	Metal lever, plastic roller	19	⊕ B	3SE5 000-0AA60	1 1 unit
	Metal lever, high-grade steel roller	19	⊕ B	3SE5 000-0AA61	1 1 unit
	Metal lever, plastic roller	50	⊕ B	3SE5 000-0AA67	1 1 unit
	Metal lever, rubber roller	50	⊕ B	3SE5 000-0AA68	1 1 unit
	High-grade steel lever, plastic roller	19	⊕ B	3SE5 000-0AA62	1 1 unit
High-grade steel lever, high-grade steel roller	19	⊕ B	3SE5 000-0AA63	1 1 unit	
	Twist levers, adjustable length				
	Metal lever, plastic roller	19	A	3SE5 000-0AA50	1 1 unit
	Metal lever, high-grade steel roller	19	B	3SE5 000-0AA51	1 1 unit
	Metal lever, plastic roller	30	B	3SE5 000-0AA55	1 1 unit
	Metal lever, plastic roller	50	B	3SE5 000-0AA57	1 1 unit
	Metal lever, rubber roller	50	B	3SE5 000-0AA58	1 1 unit
	High-grade steel lever, plastic roller	19	B	3SE5 000-0AA52	1 1 unit
	High-grade steel lever, high-grade steel roller	19	B	3SE5 000-0AA53	1 1 unit
	Rod actuators				
Aluminum rod, length 200 mm	6	B	3SE5 000-0AA80	1 1 unit	
Spring rod, length 200 mm	6	B	3SE5 000-0AA81	1 1 unit	
Plastic rod, length 200 mm	6	B	3SE5 000-0AA82	1 1 unit	

⊕ Positively driven actuator, necessary in safety circuits.

¹⁾ Can be clinch mounted (turned through 180°, rear of lever).

Limit Switches

SIRIUS 3SE5 International Limit Switches

3SE5, plastic enclosures
Ambient temperature to -40 °C

1
2
3
4
5
6
7
8
9
10
11
12
13

Selection and ordering data

Complete units

2 or 3 contacts · Degree of protection IP65 or IP66/IP67 · Cable entry M20 × 1.5

Version	Contacts	LEDs	DT	Complete units	<input type="checkbox"/>	PU (UNIT, SET, M)	PS*	PG
				Configurator				
				Order No.		Price per PU		

Complete units¹⁾ · Enclosure width 31 mm



Roller plunger
with central
fixing

Roller plungers with central fixing

Snap-action contacts 1 NO + 1 NC — ⊕ B **3SE5 232-0CD10-1AJ0** 1 1 unit 41K



Twist lever

Twist levers, type A acc. to EN 50047

With high-grade steel lever 21 mm and plastic roller 19 mm

Snap-action contacts 1 NO + 1 NC — ⊕ A **3SE5 232-0CK31-1AJ0** 1 1 unit 41K



Twist lever,
adjustable
length

Twist levers, adjustable length

With high-grade steel lever with grid hole
and plastic roller 19 mm

Snap-action contacts 1 NO + 1 NC — ⊕ A **3SE5 232-0CK62-1AJ0** 1 1 unit 41K

Snap-action contacts 1 NO + 2 NC — ⊕ B **3SE5 232-0LK62-1AJ0** 1 1 unit 41K

Complete units¹⁾ · Enclosure width 50 mm

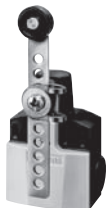

Twist lever,
adjustable
length

Twist levers

With metal lever 21 mm and plastic roller 19 mm

Snap-action contacts, integrated²⁾ 1 NO + 1 NC — ⊕ B **3SE5 242-0HK21-1AJ0** 1 1 unit 41K

Twist levers, adjustable length

With high-grade steel lever with grid hole and plastic roller
19 mm

Snap-action contacts, integrated²⁾ 1 NO + 1 NC — ⊕ B **3SE5 242-0HK62-1AJ0** 1 1 unit 41K

For online configurator see www.siemens.com/sirius/configurators.

⊕ Positive opening according to IEC 60947-5-1, Appendix K, or positively driven actuator, necessary in safety circuits.

¹⁾ Popular versions.

²⁾ Subsequent replacement of contact blocks is not possible.

Note:

If the device you require is not available as a complete unit, see "Modular System", see page 13/24.



Limit Switches

SIRIUS 3SE5 International Limit Switches

3SE5, plastic enclosures
Ambient temperature to -40 °C

Modular system

2 or 3 contacts · Degree of protection IP65 or IP66/IP67 · Cable entry M20 × 1.5

Version	Contacts	LEDs	DT	Modular system	PU (UNIT, SET, M)	PS*
						
						
				Order No.	Price per PU	

Basic switches · Enclosure width 31 mm (with rounded plunger¹⁾)



With teflon plunger

Snap-action contacts	1 NO + 1 NC	—		B	3SE5 232-0CC05-1AJ0	1	1 unit
Slow-action contacts	1 NO + 2 NC	—		B	3SE5 232-0KC05-1AJ0	1	1 unit
Snap-action contacts	1 NO + 2 NC	—		B	3SE5 232-0LC05-1AJ0	1	1 unit

Basic switch

Basic switches · Enclosure width 50 mm (with rounded plunger¹⁾)



With teflon plunger

Slow-action contacts	1 NO + 1 NC	—		B	3SE5 242-0BC05-1AJ0	1	1 unit
Snap-action contacts, integrated ²⁾	1 NO + 1 NC	—		B	3SE5 242-0HC05-1AJ0	1	1 unit

Basic switch

 For online configurator see www.siemens.com/sirius/configurators.

 Positive opening according to IEC 60947-5-1, Appendix K, or positively driven actuator, necessary in safety circuits.

¹⁾ For enclosures with widths of 31 and 50 mm, the basic switch is a complete unit with rounded plungers.

²⁾ Subsequent replacement of contact blocks is not possible.

Note:







Selection aid [see page 13/9](#).

Limit Switches

SIRIUS 3SE5 International Limit Switches

3SE5, plastic enclosures
Ambient temperature to -40 °C

1
2
3
4
5
6
7
8
9
10
11
12
13

Version	Diameter	DT	Modular system	PU (UNIT, SET, M)	PS*
	mm		Order No. Price per PU		
Operating mechanisms					
 Roller plunger	Roller plungers, type C acc. to EN 50047				
	Plastic rollers	10	⊕ B	3SE5 000-0AD03-1AJ0	1 1 unit
 Roller lever	Roller levers, type E acc. to EN 50047				
	Metal lever, plastic roller	13	⊕ B	3SE5 000-0AE10-1AJ0	1 1 unit
	High-grade steel lever, plastic roller	13	⊕ B	3SE5 000-0AE12-1AJ0	1 1 unit
 Angular roller lever	Angular roller levers				
	Metal lever, plastic roller	13	⊕ B	3SE5 000-0AF10-1AJ0	1 1 unit
	High-grade steel lever, plastic roller	13	⊕ B	3SE5 000-0AF12-1AJ0	1 1 unit
Twist actuators					
 Twist actuator	Twist actuators, plastic (without lever)				
	Switching right and/or left, adjustable		⊕ B	3SE5 000-0AK00-1AJ0	1 1 unit
Levers for twist actuators					
 Twist lever	Twist levers straight, 21 mm, type A acc. to EN 50047				
	Metal lever, plastic roller	19	⊕ B	3SE5 000-0AA21-1AJ0	1 1 unit
	High-grade steel lever, plastic roller	19	⊕ B	3SE5 000-0AA31-1AJ0	1 1 unit
 Twist lever, adjustable length	Twist levers, adjustable length, with grid hole				
	Metal lever, plastic roller	19	⊕ B	3SE5 000-0AA60-1AJ0	1 1 unit
	High-grade steel lever, plastic roller	19	⊕ B	3SE5 000-0AA62-1AJ0	1 1 unit

⊕ Positively driven actuator, necessary in safety circuits.

Limit Switches

SIRIUS 3SE5 International Limit Switches

3SE5, plastic enclosures
Ambient temperature to **-40 °C**

Modular system

2 or 3 contacts · Degree of protection IP66/IP67 · Cable entry M20 × 1.5

Version	Contacts	LEDs	DT	Modular system	PU (UNIT, SET, M)	PS*
				Order No.	Price per PU	

Basic switches · Enclosure width 40 mm



With M20 □ 1.5 connecting thread

Snap-action contacts	1 NO + 1 NC	—		B	3SE5 132-0CA00-1AJ0	1	1 unit
Slow-action contacts	1 NO + 2 NC	—		B	3SE5 132-0KA00-1AJ0	1	1 unit
Snap-action contacts	1 NO + 2 NC	—		B	3SE5 132-0LA00-1AJ0	1	1 unit

Basic switch

For online configurator see www.siemens.com/sirius/configurators.

Positive opening according to IEC 60947-5-1, Appendix K, or positively driven actuator, necessary in safety circuits.

Note:

Selection aid [see page 13/9](#).

Version	Diameter	DT	Modular system	PU (UNIT, SET, M)	PS*
	mm				
			Order No.	Price per PU	

Operating mechanisms



Rounded plungers, type B acc. to EN 50041

Plastic plunger	10		B	3SE5 000-0AC03-1AJ0	1	1 unit
-----------------	----	--	---	----------------------------	---	--------

Rounded plunger



Roller plungers, type C acc. to EN 50041

Plastic plunger, plastic roller	13		B	3SE5 000-0AD05-1AJ0	1	1 unit
---------------------------------	----	--	---	----------------------------	---	--------

Roller plunger



Roller levers

Metal lever with plastic roller, plastic base	22		B	3SE5 000-0AE05-1AJ0	1	1 unit
---	----	--	---	----------------------------	---	--------

Roller lever

Twist actuators



Twist actuators, plastic (without lever)

• For twist levers and rod actuators, switching right and/or left, adjustable			B	3SE5 000-0AJ00-1AJ0	1	1 unit
---	--	--	---	----------------------------	---	--------

Twist actuator

Levers for twist actuators

Twist lever, type A acc. to EN 50041

Metal lever, plastic roller	19		B	3SE5 000-0AA01-1AJ0	1	1 unit
High-grade steel lever, plastic roller	19		B	3SE5 000-0AA11-1AJ0	1	1 unit

Twist levers

Twist levers, adjustable length, with grid hole

Metal lever, plastic roller	19		B	3SE5 000-0AA60-1AJ0	1	1 unit
High-grade steel lever, plastic roller	19		B	3SE5 000-0AA62-1AJ0	1	1 unit

Twist lever, adjustable length

Positively driven actuator, necessary in safety circuits.

Limit Switches

SIRIUS 3SE5 International Limit Switches

3SE5, metal enclosures
Enclosure width 31 mm acc. to EN 50047

1
2
3
4
5
6
7
8
9
10
11
12
13







Selection and ordering data

Complete units

2 or 3 contacts · Degree of protection IP66/IP67 · Cable entry M20 × 1.5

Version	Contacts	LEDs	DT	Complete units	<input type="checkbox"/>	PU (UNIT, SET, M)	PS*
				Configurator			
				Order No.		Price per PU	

Complete units¹⁾ · Enclosure width 31 mm

	Rounded plungers, type B, acc. to EN 50047							
	With plunger							
	Slow-action contacts	1 NO + 1 NC	—	⊕	A	3SE5 212-0BC05	1	1 unit
	Snap-action contacts	1 NO + 1 NC	—	⊕	A	3SE5 212-0CC05	1	1 unit
	Slow-action contacts	1 NO + 2 NC	—	⊕	A	3SE5 212-0KC05	1	1 unit
	Snap-action contacts	1 NO + 2 NC	—	⊕	A	3SE5 212-0LC05	1	1 unit
	Slow-action contacts with make-before-break	1 NO + 2 NC	—	⊕	A	3SE5 212-0MC05	1	1 unit
Slow-action contacts	2 NO + 1 NC	—	⊕	A	3SE5 212-0PC05	1	1 unit	
	With increased corrosion protection							
	Slow-action contacts	1 NO + 1 NC	—	⊕	B	3SE5 212-0BC05-1CA0	1	1 unit
	Snap-action contacts	1 NO + 1 NC	—	⊕	B	3SE5 212-0CC05-1CA0	1	1 unit
	Slow-action contacts	1 NO + 2 NC	—	⊕	B	3SE5 212-0KC05-1CA0	1	1 unit
	Snap-action contacts	1 NO + 2 NC	—	⊕	B	3SE5 212-0LC05-1CA0	1	1 unit
	Slow-action contacts with make-before-break	1 NO + 2 NC	—	⊕	B	3SE5 212-0MC05-1CA0	1	1 unit
	Slow-action contacts	2 NO + 1 NC	—	⊕	B	3SE5 212-0PC05-1CA0	1	1 unit
	With M12 connector socket, 5-pole (125 V, 4 A)							
	Slow-action contacts	1 NO + 1 NC	—	⊕	B	3SE5 214-0BC05-1AC5	1	1 unit
	Snap-action contacts	1 NO + 1 NC	—	⊕	B	3SE5 214-0CC05-1AC5	1	1 unit
	Slow-action contacts	2 NC	—	⊕	B	3SE5 214-0KC05-1AE1	1	1 unit
	Snap-action contacts	2 NC	—	⊕	B	3SE5 214-0LC05-1AE1	1	1 unit
	With 2 LEDs, yellow/green							
	Slow-action contacts	1 NO + 2 NC	24 V DC	⊕	B	3SE5 212-1KC05	1	1 unit
	Snap-action contacts	1 NO + 2 NC	24 V DC	⊕	A	3SE5 212-1LC05	1	1 unit
	Slow-action contacts	1 NO + 2 NC	230 V AC	⊕	B	3SE5 212-3KC05	1	1 unit
	Snap-action contacts	1 NO + 2 NC	230 V AC	⊕	B	3SE5 212-3LC05	1	1 unit
	With M12 connector socket, 5-pole (125 V, 4 A) and 2 LEDs							
	Slow-action contacts	1 NO + 1 NC	24 V DC	⊕	B	3SE5 214-1BC05-1AF3	1	1 unit
	Snap-action contacts	1 NO + 1 NC	24 V DC	⊕	B	3SE5 214-1CC05-1AF3	1	1 unit
	Plain plungers							
	With high-grade steel plunger							
	Slow-action contacts	1 NO + 1 NC	—	⊕	B	3SE5 212-0BB01	1	1 unit
	Snap-action contacts	1 NO + 1 NC	—	⊕	B	3SE5 212-0CB01	1	1 unit
	Slow-action contacts	1 NO + 2 NC	—	⊕	B	3SE5 212-0KB01	1	1 unit
Snap-action contacts	1 NO + 2 NC	—	⊕	B	3SE5 212-0LB01	1	1 unit	
	Roller plungers, type C acc. to EN 50047							
	With plastic roller 10 mm							
	Slow-action contacts	1 NO + 1 NC	—	⊕	A	3SE5 212-0BD03	1	1 unit
	Snap-action contacts	1 NO + 1 NC	—	⊕	B	3SE5 212-0CD03	1	1 unit
	Slow-action contacts	1 NO + 2 NC	—	⊕	A	3SE5 212-0KD03	1	1 unit
Snap-action contacts	1 NO + 2 NC	—	⊕	B	3SE5 212-0LD03	1	1 unit	

For online configurator see www.siemens.com/sirius/configurators.

⊕ Positive opening according to IEC 60947-5-1, Appendix K.

¹⁾ Popular versions.

Limit Switches

SIRIUS 3SE5 International Limit Switches

3SE5, metal enclosures
Enclosure width 31 mm acc. to EN 50047

2 or 3 contacts · Degree of protection IP66/IP67 · Cable entry M20 × 1.5

Version	Contacts	LEDs	DT	Complete units	<input type="checkbox"/>	PU (UNIT, SET, M)	PS*
				Configurator			
				Order No.	Price per PU		

Complete units¹⁾ · Enclosure width 31 mm



Roller lever

Roller levers, type E acc. to EN 50047

With metal lever and plastic roller 13 mm

Slow-action contacts	1 NO + 1 NC	—	⊕ A	3SE5 212-0BE10		1	1 unit
Snap-action contacts	1 NO + 1 NC	—	⊕ B	3SE5 212-0CE10		1	1 unit
Slow-action contacts	1 NO + 2 NC	—	⊕ B	3SE5 212-0KE10		1	1 unit
Snap-action contacts	1 NO + 2 NC	—	⊕ B	3SE5 212-0LE10		1	1 unit

Angular roller levers

With metal lever and plastic roller 13 mm

Slow-action contacts	1 NO + 1 NC	—	⊕ B	3SE5 212-0BF10		1	1 unit
Snap-action contacts	1 NO + 1 NC	—	⊕ B	3SE5 212-0CF10		1	1 unit
Slow-action contacts	1 NO + 2 NC	—	⊕ B	3SE5 212-0KF10		1	1 unit
Snap-action contacts	1 NO + 2 NC	—	⊕ B	3SE5 212-0LF10		1	1 unit



Angular roller lever

Twist levers, type A acc. to EN 50047

With metal lever 21 mm and plastic roller 19 mm

Slow-action contacts	1 NO + 1 NC	—	⊕ A	3SE5 212-0BK21		1	1 unit
Snap-action contacts	1 NO + 1 NC	—	⊕ A	3SE5 212-0CK21		1	1 unit
Slow-action contacts	1 NO + 2 NC	—	⊕ B	3SE5 212-0KK21		1	1 unit
Snap-action contacts	1 NO + 2 NC	—	⊕ B	3SE5 212-0LK21		1	1 unit



Twist lever

Twist levers, adjustable length

With metal lever with grid hole and plastic roller 19 mm

Snap-action contacts	1 NO + 1 NC	—	⊕ A	3SE5 212-0CK60		1	1 unit
Slow-action contacts	1 NO + 2 NC	—	⊕ B	3SE5 212-0KK60		1	1 unit
Snap-action contacts	1 NO + 2 NC	—	⊕ B	3SE5 212-0LK60		1	1 unit



Twist lever, adjustable length

With metal lever and plastic roller 19 mm

Slow-action contacts	1 NO + 1 NC	—	A	3SE5 212-0BK50		1	1 unit
Snap-action contacts	1 NO + 1 NC	—	B	3SE5 212-0CK50		1	1 unit
Snap-action contacts	1 NO + 2 NC	—	B	3SE5 212-0LK50		1	1 unit

For online configurator see www.siemens.com/sirius/configurators.

Positive opening according to IEC 60947-5-1, Appendix K.

¹⁾ Popular versions.

Note:

If the device you require is not available as a complete unit, see "Modular System", see page 13/29.

Limit Switches

SIRIUS 3SE5 International Limit Switches

3SE5, metal enclosures
Enclosure width 31 mm acc. to EN 50047





1
2
3
4
5
6
7
8
9
10
11
12
13

Modular system

2 or 3 contacts · Degree of protection IP66/IP67 · Cable entry M20 × 1.5

Version	Contacts	LEDs	DT	Modular system	☒	PU (UNIT, SET, M)	PS*
				Configurator	⚙️		
				Order No.	Price per PU		

Basic switches · Enclosure width 31 mm (with rounded plunger¹⁾)

Version	Contacts	LEDs	DT	Modular system	☒	PU (UNIT, SET, M)	PS*
 Basic switch	With plunger						
	Slow-action contacts	1 NO + 1 NC	—	⊕ A	3SE5 212-0BC05	1	1 unit
	Snap-action contacts	1 NO + 1 NC	—	⊕ A	3SE5 212-0CC05	1	1 unit
	Slow-action contacts	1 NO + 2 NC	—	⊕ A	3SE5 212-0KC05	1	1 unit
	Snap-action contacts	1 NO + 2 NC	—	⊕ A	3SE5 212-0LC05	1	1 unit
	Slow-action contacts with make-before-break	1 NO + 2 NC	—	⊕ A	3SE5 212-0MC05	1	1 unit
Slow-action contacts	2 NO + 1 NC	—	⊕ A	3SE5 212-0PC05		1	1 unit
 With increased corrosion protection	With increased corrosion protection²⁾						
	Slow-action contacts	1 NO + 1 NC	—	⊕ B	3SE5 212-0BC05-1CA0	1	1 unit
	Snap-action contacts	1 NO + 1 NC	—	⊕ B	3SE5 212-0CC05-1CA0	1	1 unit
	Slow-action contacts	1 NO + 2 NC	—	⊕ B	3SE5 212-0KC05-1CA0	1	1 unit
	Snap-action contacts	1 NO + 2 NC	—	⊕ B	3SE5 212-0LC05-1CA0	1	1 unit
	Slow-action contacts with make-before-break	1 NO + 2 NC	—	⊕ B	3SE5 212-0MC05-1CA0	1	1 unit
Slow-action contacts	2 NO + 1 NC	—	⊕ B	3SE5 212-0PC05-1CA0		1	1 unit
 With M12 socket	With M12 connector socket, 5-pole (125 V, 4 A)						
	Slow-action contacts	1 NO + 1 NC	—	⊕ B	3SE5 214-0BC05-1AC5	1	1 unit
	Snap-action contacts	1 NO + 1 NC	—	⊕ B	3SE5 214-0CC05-1AC5	1	1 unit
	Slow-action contacts	2 NC	—	⊕ B	3SE5 214-0KC05-1AE1	1	1 unit
	Snap-action contacts	2 NC	—	⊕ B	3SE5 214-0LC05-1AE1	1	1 unit
 With 2 LEDs	With 2 LEDs, yellow/green						
	Slow-action contacts	1 NO + 2 NC	24 V DC	⊕ B	3SE5 212-1KC05	1	1 unit
	Snap-action contacts	1 NO + 2 NC	24 V DC	⊕ A	3SE5 212-1LC05	1	1 unit
	Slow-action contacts	1 NO + 2 NC	230 V AC	⊕ B	3SE5 212-3KC05	1	1 unit
	Snap-action contacts	1 NO + 2 NC	230 V AC	⊕ B	3SE5 212-3LC05	1	1 unit
 With M12 socket and 2 LEDs	With M12 connector socket, 5-pole (125 V, 4 A) and 2 LEDs						
	Slow-action contacts	1 NO + 1 NC	24 V DC	⊕ B	3SE5 214-1BC05-1AF3	1	1 unit
	Snap-action contacts	1 NO + 1 NC	24 V DC	⊕ B	3SE5 214-1CC05-1AF3	1	1 unit

⚙️ For online configurator see www.siemens.com/sirius/configurators.

⊕ Positive opening according to IEC 60947-5-1, Appendix K, or positively driven actuator, necessary in safety circuits.

¹⁾ For enclosures with widths of 31mm, the basic switch is a complete unit with rounded plungers.



²⁾ Use corresponding high-grade steel lever.

Note:

Selection aid see page 13/9.

Version	Diameter	DT	Modular system	☒	PU (UNIT, SET, M)	PS*
	mm		Order No.	Price per PU		

Operating mechanisms

 Plain plunger	Plain plungers						
	High-grade steel plungers	10	⊕ A	3SE5 000-0AB01	1	1 unit	
 Roller plunger	Roller plungers, type C acc. to EN 50047						
	Plastic rollers	10	⊕ A	3SE5 000-0AD03	1	1 unit	
	High-grade steel rollers	10	⊕ B	3SE5 000-0AD04	1	1 unit	









⊕ Positively driven actuator, necessary in safety circuits.

Limit Switches

SIRIUS 3SE5 International Limit Switches

3SE5, metal enclosures

Enclosure width 31 mm acc. to EN 50047

Version	Diameter	DT	Modular system	Price per PU	PU (UNIT, SET, M)	PS*	
	mm		Order No.				
Operating mechanisms							
	Roller plungers with central fixing						
	Plastic rollers	10	⊕ B	3SE5 000-0AD10	1	1 unit	
	High-grade steel rollers	10	⊕ B	3SE5 000-0AD11	1	1 unit	
With central fixing							
	Roller levers, type E acc. to EN 50047						
	Metal lever, plastic roller	13	⊕ A	3SE5 000-0AE10	1	1 unit	
	Metal lever, high-grade steel roller	13	⊕ B	3SE5 000-0AE11	1	1 unit	
	High-grade steel lever, plastic roller	13	⊕ B	3SE5 000-0AE12	1	1 unit	
	High-grade steel lever, high-grade steel roller	13	⊕ B	3SE5 000-0AE13	1	1 unit	
Roller lever							
	Angular roller levers						
	Metal lever, plastic roller	13	⊕ A	3SE5 000-0AF10	1	1 unit	
	Metal lever, high-grade steel roller	13	⊕ B	3SE5 000-0AF11	1	1 unit	
	High-grade steel lever, plastic roller	13	⊕ A	3SE5 000-0AF12	1	1 unit	
	High-grade steel lever, high-grade steel roller	13	⊕ B	3SE5 000-0AF13	1	1 unit	
Angular roller lever							
	Spring rods (for switches with snap-action contacts only)						
	Plastic plunger and high-grade steel spring:						
	• Length 142.5 mm (spring 50 mm, plunger 50 mm)		B	3SE5 000-0AR01	1	1 unit	
	• Length 76 mm (spring 23.5 mm, plunger 10 mm)		B	3SE5 000-0AR03	1	1 unit	
	• Length 242.5 mm (spring 150 mm, plunger 50 mm)		B	3SE5 000-0AR04	1	1 unit	
	High-grade steel plunger and spring:	7					
• Length 142.5 mm (spring 50 mm, plunger 50 mm)		B	3SE5 000-0AR02	1	1 unit		
Spring rod							
Twist actuators							
	Twist actuators, plastic (without lever)						
	Switching right and/or left, adjustable		⊕ A	3SE5 000-0AK00	1	1 unit	
Levers for twist actuators							
	Twist levers, straight, type A acc. to EN 50047						
	Metal lever 21 mm, plastic roller	19	⊕ A	3SE5 000-0AA21	1	1 unit	
	Metal lever 21 mm, high-grade steel roller	19	⊕ B	3SE5 000-0AA22	1	1 unit	
	Metal lever 21 mm, roller with ball bearing	19	⊕ B	3SE5 000-0AA23	1	1 unit	
	Metal lever 21 mm, plastic roller	30	⊕ B	3SE5 000-0AA25	1	1 unit	
	High-grade steel lever 21 mm, plastic roller	19	⊕ B	3SE5 000-0AA31	1	1 unit	
	High-grade steel lever 21 mm, high-grade steel roller	19	⊕ B	3SE5 000-0AA32	1	1 unit	
	Twist levers 30 mm, straight¹⁾						
	Metal lever, plastic roller	19	⊕ B	3SE5 000-0AA24	1	1 unit	
	Metal lever, plastic roller	30	⊕ B	3SE5 000-0AA26	1	1 unit	
Twist levers, adjustable length, with grid hole							
	Metal lever, plastic roller	19	⊕ B	3SE5 000-0AA60	1	1 unit	
	Metal lever, high-grade steel roller	19	⊕ B	3SE5 000-0AA61	1	1 unit	
	Metal lever, plastic roller	50	⊕ B	3SE5 000-0AA67	1	1 unit	
	Metal lever, rubber roller	50	⊕ B	3SE5 000-0AA68	1	1 unit	
	High-grade steel lever, plastic roller	19	⊕ B	3SE5 000-0AA62	1	1 unit	
	High-grade steel lever, high-grade steel roller	19	⊕ B	3SE5 000-0AA63	1	1 unit	
	Twist levers, adjustable length						
	Metal lever, plastic roller	19	A	3SE5 000-0AA50	1	1 unit	
	Metal lever, high-grade steel roller	19	B	3SE5 000-0AA51	1	1 unit	
	Metal lever, plastic roller	30	B	3SE5 000-0AA55	1	1 unit	
	Metal lever, plastic roller	50	B	3SE5 000-0AA57	1	1 unit	
	Metal lever, rubber roller	50	B	3SE5 000-0AA58	1	1 unit	
	High-grade steel lever, plastic roller	19	B	3SE5 000-0AA52	1	1 unit	
	High-grade steel lever, high-grade steel roller	19	B	3SE5 000-0AA53	1	1 unit	
Rod actuators, type D acc. to EN 50041							
Rod actuator	Aluminum rod, length 200 mm	6	B	3SE5 000-0AA80	1	1 unit	
	Spring rod, length 200 mm	6	B	3SE5 000-0AA81	1	1 unit	
	Plastic rod, length 200 mm	6	B	3SE5 000-0AA82	1	1 unit	
	Plastic rod, length 330 mm	6	B	3SE5 000-0AA83	1	1 unit	

⊕ Positively driven actuator, necessary in safety circuits.

¹⁾ Can be clinch mounted (turned through 180°, rear of lever).

Limit Switches

SIRIUS 3SE5 International Limit Switches

3SE5, metal enclosures
Enclosure width 40 mm acc. to EN 50041

1
2
3
4
5
6
7
8
9
10
11
12
13

Selection and ordering data

Complete units

2 or 3 contacts · Degree of protection IP66/IP67 · Cable entry M20 × 1.5

Version	Contacts	LEDs	DT	Complete units	<input type="checkbox"/>	PU (UNIT, SET, M)	PS*
				Configurator			
				Order No.		Price per PU	

Complete units¹⁾ · Enclosure width 40 mm

Image	Description	Contacts	LEDs	DT	Order No.	Price per PU	PU	PS*
	Plain plungers							
	With high-grade steel plunger							
	Slow-action contacts	1 NO + 1 NC	—	⊕ A	3SE5 112-0BB01		1	1 unit
	Snap-action contacts	1 NO + 1 NC	—	⊕ A	3SE5 112-0CB01		1	1 unit
	Snap-action contacts	1 NO + 2 NC	—	⊕ ▶	3SE5 112-0KB01		1	1 unit
	Rounded plungers, type B acc. to EN 50041							
	With high-grade steel plungers, with 3 mm overtravel							
	Slow-action contacts	1 NO + 1 NC	—	⊕ ▶	3SE5 112-0BC02		1	1 unit
	Snap-action contacts	1 NO + 1 NC	—	⊕ ▶	3SE5 112-0CC02		1	1 unit
	Snap-action contacts	1 NO + 2 NC	—	⊕ B	3SE5 112-0KC02		1	1 unit
	Roller plungers, type C acc. to EN 50041							
	With high-grade steel roller 13 mm, with 3 mm overtravel							
	Slow-action contacts	1 NO + 1 NC	—	⊕ ▶	3SE5 112-0BD02		1	1 unit
	Snap-action contacts	1 NO + 1 NC	—	⊕ ▶	3SE5 112-0CD02		1	1 unit
	Snap-action contacts	1 NO + 2 NC	—	⊕ ▶	3SE5 112-0LD02		1	1 unit
	With M12 connector socket, 5-pole (125 V, 4 A) and 2 LEDs							
	Snap-action contacts	1 NO + 1 NC	24 V DC	⊕ B	3SE5 114-1CD02-1AF3		1	1 unit
	Roller levers							
	With metal lever and plastic roller 22 mm							
	Slow-action contacts	1 NO + 1 NC	—	⊕ ▶	3SE5 112-0BE01		1	1 unit
	Snap-action contacts	1 NO + 1 NC	—	⊕ ▶	3SE5 112-0CE01		1	1 unit
	Snap-action contacts	1 NO + 2 NC	—	⊕ B	3SE5 112-0KE01		1	1 unit
	Angular roller levers							
	With metal lever and plastic roller 22 mm							
	Snap-action contacts	1 NO + 2 NC	—	⊕ B	3SE5 112-0LE01		1	1 unit
	Spring rods							
	Length 142.5 mm, with plastic plunger 50 mm							
	Snap-action contacts	1 NO + 1 NC	—	▶	3SE5 112-0CR01		1	1 unit

For online configurator see www.siemens.com/sirius/configurators.

Positive opening according to IEC 60947-5-1, Appendix K.

¹⁾ Popular versions.

Limit Switches

SIRIUS 3SE5 International Limit Switches

3SE5, metal enclosures
Enclosure width 40 mm acc. to EN 50041

2 or 3 contacts · Degree of protection IP66/IP67 · Cable entry M20 × 1.5

Version	Contacts	LEDs	DT	Complete units	<input type="checkbox"/>	PU (UNIT, SET, M)	PS*
				Configurator			
				Order No.	Price per PU		

Complete units¹⁾ · Enclosure width 40 mm



Twist lever

Twist levers, type A acc. to EN 50041

With metal lever 27 mm and plastic roller 19 mm

Slow-action contacts	1 NO + 1 NC	—	⊕ ▶	3SE5 112-0BH01		1	1 unit
Snap-action contacts	1 NO + 1 NC	—	⊕ ▶	3SE5 112-0CH01		1	1 unit
Slow-action contacts	1 NO + 2 NC	—	⊕ ▶	3SE5 112-0KH01		1	1 unit
Snap-action contacts	1 NO + 2 NC	—	⊕ B	3SE5 112-0LH01		1	1 unit

With M12 connector socket, 5-pole (125 V, 4 A)

Snap-action contacts	1 NO + 1 NC	—	⊕ A	3SE5 114-0CH01-1AC5		1	1 unit
----------------------	-------------	---	-----	----------------------------	--	---	--------

With M12 connector socket, 5-pole (125 V, 4 A) and 2 LEDs

Snap-action contacts	1 NO + 1 NC	24 V DC	⊕ B	3SE5 114-1CH01-1AF3		1	1 unit
----------------------	-------------	---------	-----	----------------------------	--	---	--------

With metal lever 27 mm and high-grade steel roller 19 mm

Slow-action contacts	1 NO + 1 NC	—	⊕ B	3SE5 112-0BH02		1	1 unit
Snap-action contacts	1 NO + 1 NC	—	⊕ ▶	3SE5 112-0CH02		1	1 unit

With M12 connector socket, 5-pole (125 V, 4 A) and 2 LEDs

Snap-action contacts	1 NO + 1 NC	—	⊕ B	3SE5 114-1CH02-1AF3		1	1 unit
----------------------	-------------	---	-----	----------------------------	--	---	--------

With metal lever 30 mm and plastic roller 19 mm

Snap-action contacts	1 NO + 1 NC	—	⊕ A	3SE5 112-0CH24		1	1 unit
----------------------	-------------	---	-----	-----------------------	--	---	--------

Twist levers, adjustable length

With metal lever with grid hole and plastic roller 19 mm

Slow-action contacts	1 NO + 1 NC	—	⊕ ▶	3SE5 112-0BH60		1	1 unit
Snap-action contacts	1 NO + 1 NC	—	⊕ ▶	3SE5 112-0CH60		1	1 unit
Snap-action contacts	1 NO + 2 NC	—	⊕ B	3SE5 112-0LH60		1	1 unit



Twist lever, adjustable length, with grid hole

With metal lever and plastic roller 19 mm

Slow-action contacts	1 NO + 1 NC	—	B	3SE5 112-0BH50		1	1 unit
Snap-action contacts	1 NO + 1 NC	—	▶	3SE5 112-0CH50		1	1 unit
Snap-action contacts	1 NO + 2 NC	—	B	3SE5 112-0LH50		1	1 unit

With M12 connector socket, 8-pole (30 V, 2 A) and 2 LEDs

Snap-action contacts	1 NO + 2 NC	24 V DC	B	3SE5 114-1LH50-1AD4		1	1 unit
----------------------	-------------	---------	---	----------------------------	--	---	--------

With metal lever and high-grade steel roller 19 mm

Snap-action contacts	1 NO + 1 NC	—	B	3SE5 112-0CH51		1	1 unit
----------------------	-------------	---	---	-----------------------	--	---	--------



Twist lever, adjustable length

Fork levers, latching

With metal lever and 2 plastic rollers 19 mm

Snap-action contacts	1 NO + 1 NC	—	⊕ B	3SE5 112-0CT11		1	1 unit
----------------------	-------------	---	-----	-----------------------	--	---	--------



Fork lever

Rod actuators, type D, acc. to EN 50041

With aluminum rod, length 200 mm

Snap-action contacts	1 NO + 1 NC	—	▶	3SE5 112-0CH80		1	1 unit
----------------------	-------------	---	---	-----------------------	--	---	--------

With plastic rod, length 200 mm

Snap-action contacts	1 NO + 1 NC	—	B	3SE5 112-0CH82		1	1 unit
----------------------	-------------	---	---	-----------------------	--	---	--------



Rod actuator

For online configurator see www.siemens.com/sirius/configurators.

Positive opening according to IEC 60947-5-1, Appendix K.

¹⁾ Popular versions.

Note:

If the device you require is not available as a complete unit, see "Modular System", page 13/33.









Limit Switches

SIRIUS 3SE5 International Limit Switches

3SE5, metal enclosures
Enclosure width 40 mm acc. to EN 50041

Modular system

2 or 3 contacts · Degree of protection IP66/IP67 · Cable entry M20 × 1.5

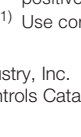
Version	Contacts	LEDs	DT	Modular system	PU (UNIT, SET, M)	PS*
				Configurator		
				Order No.	Price per PU	
Basic switches · Enclosure width 40 mm						
	With M20 × 1.5 connecting thread					
	Slow-action contacts	1 NO + 1 NC	—	⊕ ▶	3SE5 112-0BA00	1 1 unit
	Snap-action contacts	1 NO + 1 NC	—	⊕ ▶	3SE5 112-0CA00	1 1 unit
	• Gold-plated contacts			⊕ B	3SE5 112-0CA00-1AC1	1 1 unit
	Slow-action contacts	1 NO + 2 NC	—	⊕ A	3SE5 112-0KA00	1 1 unit
	Snap-action contacts	1 NO + 2 NC	—	⊕ ▶	3SE5 112-0LA00	1 1 unit
	Slow-action contacts with make-before-break	1 NO + 2 NC	—	⊕ ▶	3SE5 112-0MA00	1 1 unit
	Slow-action contacts	2 NO + 1 NC	—	⊕ ▶	3SE5 112-0PA00	1 1 unit
	With increased corrosion protection¹⁾					
	Slow-action contacts	1 NO + 1 NC	—	⊕ B	3SE5 112-0BA00-1CA0	1 1 unit
	Snap-action contacts	1 NO + 1 NC	—	⊕ B	3SE5 112-0CA00-1CA0	1 1 unit
	Slow-action contacts	1 NO + 2 NC	—	⊕ B	3SE5 112-0KA00-1CA0	1 1 unit
	Snap-action contacts	1 NO + 2 NC	—	⊕ B	3SE5 112-0LA00-1CA0	1 1 unit
	Slow-action contacts with make-before-break	1 NO + 2 NC	—	⊕ B	3SE5 112-0MA00-1CA0	1 1 unit
	Slow-action contacts	2 NO + 1 NC	—	⊕ B	3SE5 112-0PA00-1CA0	1 1 unit
	With M12 connector socket, 5-pole (125 V, 4 A)					
	Slow-action contacts	1 NO + 1 NC	—	⊕ B	3SE5 114-0BA00-1AC5	1 1 unit
	Snap-action contacts	1 NO + 1 NC	—	⊕ ▶	3SE5 114-0CA00-1AC5	1 1 unit
	Slow-action contacts	2 NC	—	⊕ B	3SE5 114-0KA00-1AE1	1 1 unit
	Snap-action contacts	2 NC	—	⊕ B	3SE5 114-0LA00-1AE1	1 1 unit
	With connector socket, 6-pole + PE (250 V, 10 A)					
	Slow-action contacts	1 NO + 2 NC	—	⊕ B	3SE5 115-0KA00-1AD1	1 1 unit
	Snap-action contacts	1 NO + 2 NC	—	⊕ ▶	3SE5 115-0LA00-1AD1	1 1 unit
	With connector socket, 6-pole + PE (250 V, 10 A) and quick-release device					
	Snap-action contacts	1 NO + 1 NC	—	⊕ B	3SE5 115-0CA00-1AD0	1 1 unit
	With 2 LEDs, yellow/green					
	Slow-action contacts	1 NO + 2 NC	24 V DC	⊕ B	3SE5 112-1KA00	1 1 unit
	Snap-action contacts	1 NO + 2 NC	24 V DC	⊕ ▶	3SE5 112-1LA00	1 1 unit
	Slow-action contacts	1 NO + 2 NC	230 V AC	⊕ B	3SE5 112-3KA00	1 1 unit
	Snap-action contacts	1 NO + 2 NC	230 V AC	⊕ B	3SE5 112-3LA00	1 1 unit
	With M12 connector socket, 5-pole (125 V, 4 A) and 2 LEDs					
	Slow-action contacts	1 NO + 1 NC	24 V DC	⊕ B	3SE5 114-1BA00-1AF3	1 1 unit
	Snap-action contacts	1 NO + 1 NC	24 V DC	⊕ B	3SE5 114-1CA00-1AF3	1 1 unit
	With M12 connector socket, 8-pole (30 V, 2 A) and 2 LEDs					
	Snap-action contacts	1 NO + 2 NC	24 V DC	⊕ B	3SE5 114-1LA00-1AD4	1 1 unit
	With connector socket, 6-pole + PE (10 A), and 2 LEDs					
	Slow-action contacts	1 NO + 1 NC	24 V DC	⊕ B	3SE5 115-1BA00-1AF2	1 1 unit
	Snap-action contacts	1 NO + 1 NC	24 V DC	⊕ B	3SE5 115-1CA00-1AF2	1 1 unit
	Snap-action contacts	2 NC	24 V DC	⊕ B	3SE5 115-1LA00-1AD2	1 1 unit

For online configurator see www.siemens.com/sirius/configurators.

⊕ Positive opening according to IEC 60947-5-1, Appendix K, or positively driven actuator, necessary in safety circuits.

¹⁾ Use corresponding high-grade steel lever.







Note:

Selection aid, see page 13/9.

Limit Switches

SIRIUS 3SE5 International Limit Switches

3SE5, metal enclosures
Enclosure width 40 mm acc. to EN 50041

Version	Diameter	DT	Modular system	Price per PU	PU (UNIT, SET, M)	PS*	
	mm		Order No.				
Operating mechanisms							
	Plain plungers						
	High-grade steel plungers	10	⊕ A	3SE5 000-0AB01	1	1 unit	
	Rounded plungers, type B acc. to EN 50041						
	High-grade steel plungers, with 3 mm overtravel	10	⊕ ▶	3SE5 000-0AC02	1	1 unit	
	Roller plungers, type C acc. to EN 50041						
	High-grade steel roller, with 3 mm overtravel	13	⊕ ▶	3SE5 000-0AD02	1	1 unit	
	Roller levers						
	Metal lever, plastic roller	22	⊕ ▶	3SE5 000-0AE01	1	1 unit	
	Metal lever, high-grade steel roller	22	⊕ ▶	3SE5 000-0AE02	1	1 unit	
	High-grade steel lever, plastic roller	22	⊕ B	3SE5 000-0AE03	1	1 unit	
	Angular roller levers						
	Metal lever, plastic roller	22	⊕ ▶	3SE5 000-0AF01	1	1 unit	
	Metal lever, high-grade steel roller	22	⊕ B	3SE5 000-0AF02	1	1 unit	
	High-grade steel lever, plastic roller	22	⊕ B	3SE5 000-0AF03	1	1 unit	
	Spring rods (for switches with snap-action contacts only)						
	Plastic plunger and high-grade steel spring:	7					
	• Length 142.5 mm (spring 50 mm, plunger 50 mm)		B	3SE5 000-0AR01	1	1 unit	
	• Length 76 mm (spring 23.5 mm, plunger 10 mm)		B	3SE5 000-0AR03	1	1 unit	
• Length 242.5 mm (spring 150 mm, plunger 50 mm)		B	3SE5 000-0AR04	1	1 unit		
High-grade steel plunger and spring:	7						
• Length 142.5 mm (spring 50 mm, plunger 50 mm)		B	3SE5 000-0AR02	1	1 unit		
Twist actuators							
	Twist actuators, metal (without lever)						
	• For twist levers and rod actuators, switching right and/or left, adjustable		⊕ A	3SE5 000-0AH00	1	1 unit	
	Levers for twist actuators						
	• For fork levers, latching		⊕ ▶	3SE5 000-0AT10	1	1 unit	
	Twist levers, offset, type A acc. to EN 50041						
	Metal lever 27 mm, plastic roller	19	⊕ A	3SE5 000-0AA01	1	1 unit	
	Metal lever 27 mm, high-grade steel roller	19	⊕ A	3SE5 000-0AA02	1	1 unit	
	Metal lever 27 mm, roller with ball bearing	19	⊕ B	3SE5 000-0AA03	1	1 unit	
	Metal lever 27 mm, 2 plastic rollers	19	⊕ B	3SE5 000-0AA04	1	1 unit	
	Metal lever 27 mm, plastic roller	30	⊕ B	3SE5 000-0AA05	1	1 unit	
	Metal lever 27 mm, rubber roller	50	⊕ B	3SE5 000-0AA08	1	1 unit	
	High-grade steel lever 27 mm, plastic roller	19	⊕ B	3SE5 000-0AA11	1	1 unit	
	High-grade steel lever 27 mm, high-grade steel roller	19	⊕ B	3SE5 000-0AA12	1	1 unit	
	Metal lever 35 mm, plastic roller	19	⊕ B	3SE5 000-0AA15	1	1 unit	
	Twist levers 30 mm, straight¹⁾						
	Metal lever, plastic roller	19	⊕ B	3SE5 000-0AA24	1	1 unit	
	Twist levers, adjustable length, with grid hole						
	Metal lever, plastic roller	19	⊕ B	3SE5 000-0AA60	1	1 unit	
	Metal lever, high-grade steel roller	19	⊕ B	3SE5 000-0AA61	1	1 unit	
Metal lever, rubber roller	50	⊕ B	3SE5 000-0AA68	1	1 unit		
High-grade steel lever, plastic roller	19	⊕ B	3SE5 000-0AA62	1	1 unit		
High-grade steel lever, high-grade steel roller	19	⊕ B	3SE5 000-0AA63	1	1 unit		
Twist levers, adjustable length							
Metal lever, plastic roller	19	A	3SE5 000-0AA50	1	1 unit		
Metal lever, high-grade steel roller	19	B	3SE5 000-0AA51	1	1 unit		
Metal lever, plastic roller	30	B	3SE5 000-0AA55	1	1 unit		
Metal lever, rubber roller	50	B	3SE5 000-0AA58	1	1 unit		
High-grade steel lever, plastic roller	19	B	3SE5 000-0AA52	1	1 unit		
High-grade steel lever, high-grade steel roller	19	B	3SE5 000-0AA53	1	1 unit		
Fork levers (for switches with snap-action contacts only)							
2 metal levers, 2 plastic rollers	19	⊕ ▶	3SE5 000-0AT01	1	1 unit		
2 metal levers, 2 high-grade steel rollers	19	⊕ B	3SE5 000-0AT02	1	1 unit		
2 high-grade steel levers, 2 plastic rollers	19	⊕ B	3SE5 000-0AT03	1	1 unit		
Rod actuators, type D acc. to EN 50041							
Aluminum rod, length 200 mm	6	B	3SE5 000-0AA80	1	1 unit		
Spring rod, length 200 mm	6	B	3SE5 000-0AA81	1	1 unit		
Plastic rod, length 200 mm	6	B	3SE5 000-0AA82	1	1 unit		

⊕ Positively driven actuator, necessary in safety circuits.

¹⁾ Can be clinch mounted (turned through 180°, rear of lever).

Limit Switches

SIRIUS 3SE5 International Limit Switches

3SE5, metal enclosures
Enclosure width 56 mm

1
2
3
4
5
6
7
8
9
10
11
12
13





Selection and ordering data

Complete units

2 or 3 contacts · Degree of protection IP66/IP67 · Cable entry 3 × (M20 × 1.5)

Version	Contacts	LEDs	DT	Complete units	<input type="checkbox"/>	PU (UNIT, SET, M)	PS*
				Configurator			
				Order No.		Price per PU	

Complete units¹⁾ · Enclosure width 56 mm

 Plain plunger	Plain plungers						
	With high-grade steel plunger						
	Slow-action contacts	1 NO + 1 NC	—	⊕ B	3SE5 122-0BB01	1	1 unit
	Snap-action contacts	1 NO + 1 NC	—	⊕ B	3SE5 122-0CB01	1	1 unit
	Slow-action contacts	1 NO + 2 NC	—	⊕ B	3SE5 122-0KB01	1	1 unit
	Snap-action contacts	1 NO + 2 NC	—	⊕ B	3SE5 122-0LB01	1	1 unit
	Slow-action contacts	2 NO + 1 NC	—	⊕ B	3SE5 122-0PB01	1	1 unit
 Rounded plunger	Rounded plungers						
	With high-grade steel plungers, with 3 mm overtravel						
	Slow-action contacts	1 NO + 1 NC	—	⊕ B	3SE5 122-0BC02	1	1 unit
	Snap-action contacts	1 NO + 1 NC	—	⊕ ▶	3SE5 122-0CC02	1	1 unit
	Slow-action contacts	1 NO + 2 NC	—	⊕ B	3SE5 122-0KC02	1	1 unit
	Snap-action contacts	1 NO + 2 NC	—	⊕ B	3SE5 122-0LC02	1	1 unit
	Slow-action contacts	2 NO + 1 NC	—	⊕ B	3SE5 122-0PC02	1	1 unit
 Roller plunger	Roller plungers						
	With high-grade steel roller 13 mm, with 3 mm overtravel						
	Slow-action contacts	1 NO + 1 NC	—	⊕ ▶	3SE5 122-0BD02	1	1 unit
	Snap-action contacts	1 NO + 1 NC	—	⊕ ▶	3SE5 122-0CD02	1	1 unit
	Slow-action contacts	1 NO + 2 NC	—	⊕ ▶	3SE5 122-0KD02	1	1 unit
	Snap-action contacts	1 NO + 2 NC	—	⊕ B	3SE5 122-0LD02	1	1 unit
 Roller lever	Roller levers						
	With metal lever and plastic roller 22 mm						
	Slow-action contacts	1 NO + 1 NC	—	⊕ ▶	3SE5 122-0BE01	1	1 unit
	Snap-action contacts	1 NO + 1 NC	—	⊕ ▶	3SE5 122-0CE01	1	1 unit
	Slow-action contacts	1 NO + 2 NC	—	⊕ ▶	3SE5 122-0KE01	1	1 unit
	Snap-action contacts	1 NO + 2 NC	—	⊕ B	3SE5 122-0LE01	1	1 unit
	Slow-action contacts	2 NO + 1 NC	—	⊕ B	3SE5 122-0PE01	1	1 unit
 Angular roller lever	Angular roller levers						
	With metal lever and plastic roller 22 mm						
	Slow-action contacts	1 NO + 1 NC	—	⊕ B	3SE5 122-0BF01	1	1 unit
	Snap-action contacts	1 NO + 1 NC	—	⊕ ▶	3SE5 122-0CF01	1	1 unit
	Slow-action contacts	2 NO + 1 NC	—	⊕ B	3SE5 122-0PF01	1	1 unit

For online configurator see www.siemens.com/sirius/configurators.

Positive opening according to IEC 60947-5-1, Appendix K.

¹⁾ Popular versions.

Limit Switches

SIRIUS 3SE5 International Limit Switches

3SE5, metal enclosures
Enclosure width 56 mm

2 or 3 contacts · Degree of protection IP66/IP67 · Cable entry 3 × (M20 × 1.5)

Version	Contacts	LEDs	DT	Complete units	<input type="checkbox"/>	PU (UNIT, SET, M)	PS*
				Configurator			
				Order No.	Price per PU		

Complete units¹⁾ · Enclosure width 56 mm



Spring rod

Spring rods

Length 142.5 mm, with plastic plunger 50 mm

Snap-action contacts

1 NO + 1 NC —



3SE5 122-0CR01

1

1 unit



Twist lever

Twist levers

With metal lever 27 mm and plastic roller 19 mm

Slow-action contacts

1 NO + 1 NC —



3SE5 122-0BH01

1

1 unit

Snap-action contacts

1 NO + 1 NC —



3SE5 122-0CH01

1

1 unit

Slow-action contacts

1 NO + 2 NC —



3SE5 122-0KH01

1

1 unit

Snap-action contacts

1 NO + 2 NC —



3SE5 122-0LH01

1

1 unit

Slow-action contacts

2 NO + 1 NC —



3SE5 122-0PH01

1

1 unit

With metal lever 27 mm and high-grade steel roller 19 mm

Snap-action contacts

1 NO + 1 NC —



3SE5 122-0CH02

1

1 unit

Snap-action contacts

1 NO + 2 NC —



3SE5 122-0LH02

1

1 unit



Twist lever, adjustable length

Twist levers, adjustable length

With metal lever with grid hole and plastic roller 19 mm

Slow-action contacts

1 NO + 1 NC —



3SE5 122-0BH60

1

1 unit

Snap-action contacts

1 NO + 1 NC —



3SE5 122-0CH60

1

1 unit

Snap-action contacts

1 NO + 2 NC —



3SE5 122-0LH60

1

1 unit

With metal lever and plastic roller 19 mm

Slow-action contacts

1 NO + 1 NC —

B

3SE5 122-0BH50

1

1 unit

Snap-action contacts

1 NO + 1 NC —



3SE5 122-0CH50

1

1 unit

Snap-action contacts

1 NO + 2 NC —

B

3SE5 122-0LH50

1

1 unit



Fork lever

Fork levers, latching

With metal lever and 2 plastic rollers 19 mm

Snap-action contacts

1 NO + 1 NC —



3SE5 122-0CT11

1

1 unit



Rod actuator

Rod actuators

With aluminum rod, length 200 mm

Snap-action contacts

1 NO + 1 NC —

B

3SE5 122-0CH80

1

1 unit

With plastic rod, length 200 mm

Snap-action contacts

1 NO + 1 NC —

B

3SE5 122-0CH82

1

1 unit

Note:

If the device you require is not available as a complete unit, see "Modular System", page 13/37.

For online configurator see www.siemens.com/sirius/configurators.

Positive opening according to IEC 60947-5-1, Appendix K.

¹⁾ Popular versions.

Limit Switches

SIRIUS 3SE5 International Limit Switches

3SE5, metal enclosures
Enclosure width 56 mm

Modular system

2 or 3 contacts · Degree of protection IP66/IP67 · Cable entry 3 × (M20 × 1.5)

Version	Contacts	LEDs	DT	Modular system	PU (UNIT, SET, M)	PS*
				Order No.	Price per PU	

Basic switches · Enclosure width 56 mm

Version	Contacts	LEDs	DT	Modular system	PU (UNIT, SET, M)	PS*
With 3 x M20 x 1.5 connecting thread						
	Slow-action contacts	1 NO + 1 NC	—	➔ ▶ 3SE5 122-0BA00	1	1 unit
	Snap-action contacts	1 NO + 1 NC	—	➔ ▶ 3SE5 122-0CA00	1	1 unit
	Slow-action contacts	1 NO + 2 NC	—	➔ B 3SE5 122-0KA00	1	1 unit
	Snap-action contacts	1 NO + 2 NC	—	➔ A 3SE5 122-0LA00	1	1 unit
	Slow-action contacts with make-before-break	1 NO + 2 NC	—	➔ A 3SE5 122-0MA00	1	1 unit
	Slow-action contacts	2 NO + 1 NC	—	➔ ▶ 3SE5 122-0PA00	1	1 unit
With increased corrosion protection¹⁾						
	Slow-action contacts	1 NO + 1 NC	—	➔ B 3SE5 122-0BA00-1CA0	1	1 unit
	Snap-action contacts	1 NO + 1 NC	—	➔ B 3SE5 122-0CA00-1CA0	1	1 unit
	Slow-action contacts	1 NO + 2 NC	—	➔ B 3SE5 122-0KA00-1CA0	1	1 unit
	Snap-action contacts	1 NO + 2 NC	—	➔ B 3SE5 122-0LA00-1CA0	1	1 unit
	Slow-action contacts with make-before-break	1 NO + 2 NC	—	➔ B 3SE5 122-0MA00-1CA0	1	1 unit
	Slow-action contacts	2 NO + 1 NC	—	➔ B 3SE5 122-0PA00-1CA0	1	1 unit
With 2 LEDs, yellow/green						
	Slow-action contacts	1 NO + 2 NC	24 V DC	➔ B 3SE5 122-1KA00	1	1 unit
	Snap-action contacts	1 NO + 2 NC	24 V DC	➔ B 3SE5 122-1LA00	1	1 unit
	Slow-action contacts	1 NO + 2 NC	230 V AC	➔ B 3SE5 122-3KA00	1	1 unit
	Snap-action contacts	1 NO + 2 NC	230 V AC	➔ B 3SE5 122-3LA00	1	1 unit

For online configurator see www.siemens.com/sirius/configurators.

Positive opening according to IEC 60947-5-1, Appendix K, or positively driven actuator, necessary in safety circuits.

¹⁾ Use corresponding high-grade steel lever.

Note:

Selection aid see page 13/9.

Version	Diameter	DT	Modular system	PU (UNIT, SET, M)	PS*
	mm				
			Order No.	Price per PU	





Operating mechanisms

Version	Diameter	DT	Modular system	PU (UNIT, SET, M)	PS*
Plain plungers					
	High-grade steel plungers	10	➔ A 3SE5 000-0AB01	1	1 unit
	Rounded plungers, type B acc. to EN 50041				
	High-grade steel plungers, with 3 mm overtravel	10	➔ B 3SE5 000-0AC02	1	1 unit
	Roller plungers, type C acc. to EN 50041				
	High-grade steel roller, with 3 mm overtravel	13	➔ B 3SE5 000-0AD02	1	1 unit
	Roller levers				
	Metal lever, plastic roller	22	➔ A 3SE5 000-0AE01	1	1 unit
	Metal lever, high-grade steel roller	22	➔ B 3SE5 000-0AE02	1	1 unit
	High-grade steel lever, plastic roller	22	➔ B 3SE5 000-0AE03	1	1 unit
	High-grade steel lever, high-grade steel roller	22	➔ B 3SE5 000-0AE04	1	1 unit
Angular roller levers					
	Metal lever, plastic roller	22	➔ A 3SE5 000-0AF01	1	1 unit
	Metal lever, high-grade steel roller	22	➔ B 3SE5 000-0AF02	1	1 unit
	High-grade steel lever, plastic roller	22	➔ B 3SE5 000-0AF03	1	1 unit
	High-grade steel lever, high-grade steel roller	22	➔ B 3SE5 000-0AF04	1	1 unit
Spring rods (for switches with snap-action contacts only)					
	Plastic plunger and high-grade steel spring:	7			
	• Length 142.5 mm (spring 50 mm, plunger 50 mm)		B 3SE5 000-0AR01	1	1 unit
	• Length 76 mm (spring 23.5 mm, plunger 10 mm)		B 3SE5 000-0AR03	1	1 unit
	• Length 242.5 mm (spring 150 mm, plunger 50 mm)		B 3SE5 000-0AR04	1	1 unit
	High-grade steel plunger and spring:	7			
	• Length 142.5 mm (spring 50 mm, plunger 50 mm)		B 3SE5 000-0AR02	1	1 unit

Limit Switches

SIRIUS 3SE5 International Limit Switches

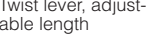
3SE5, metal enclosures
Enclosure width 56 mm

Version	Diameter	DT	Modular system	PU (UNIT, SET, M)	PS*	
	mm		Order No.	Price per PU		
Twist actuators						
	Twist actuators, metal (without lever)					
	<ul style="list-style-type: none"> For twist levers and rod actuators, switching right and/or left, adjustable For fork levers, latching 					
		⊕ A	3SE5 000-0AH00	1	1 unit	
		⊕ B	3SE5 000-0AT10	1	1 unit	
Levers for twist actuators						
	Twist levers 27 mm, offset, type A acc. to EN 50041					
	Metal lever, plastic roller	19	⊕ A	3SE5 000-0AA01	1	1 unit
	Metal lever, high-grade steel roller	19	⊕ A	3SE5 000-0AA02	1	1 unit
	Metal lever, roller with ball bearing	19	⊕ B	3SE5 000-0AA03	1	1 unit
	Metal lever, 2 plastic rollers	19	⊕ B	3SE5 000-0AA04	1	1 unit
	Metal lever, plastic roller	30	⊕ B	3SE5 000-0AA05	1	1 unit
	Metal lever, plastic roller	50	⊕ B	3SE5 000-0AA07	1	1 unit
	Metal lever, rubber roller	50	⊕ B	3SE5 000-0AA08	1	1 unit
	High-grade steel lever, plastic roller	19	⊕ B	3SE5 000-0AA11	1	1 unit
	High-grade steel lever, high-grade steel roller	19	⊕ B	3SE5 000-0AA12	1	1 unit
	Twist levers 35 mm, offset					
	Metal lever, plastic roller	19	⊕ B	3SE5 000-0AA15	1	1 unit
Twist levers 30 mm, straight¹⁾						
Metal lever, plastic roller	19	⊕ B	3SE5 000-0AA24	1	1 unit	
Metal lever, plastic roller	30	⊕ B	3SE5 000-0AA26	1	1 unit	
	Twist levers, adjustable length, with grid hole					
	Metal lever, plastic roller	19	⊕ B	3SE5 000-0AA60	1	1 unit
	Metal lever, high-grade steel roller	19	⊕ B	3SE5 000-0AA61	1	1 unit
	Metal lever, plastic roller	50	⊕ B	3SE5 000-0AA67	1	1 unit
	Metal lever, rubber roller	50	⊕ B	3SE5 000-0AA68	1	1 unit
	High-grade steel lever, plastic roller	19	⊕ B	3SE5 000-0AA62	1	1 unit
High-grade steel lever, high-grade steel roller	19	⊕ B	3SE5 000-0AA63	1	1 unit	
	Twist levers, adjustable length					
	Metal lever, plastic roller	19	A	3SE5 000-0AA50	1	1 unit
	Metal lever, high-grade steel roller	19	B	3SE5 000-0AA51	1	1 unit
	Metal lever, plastic roller	30	B	3SE5 000-0AA55	1	1 unit
	Metal lever, plastic roller	50	B	3SE5 000-0AA57	1	1 unit
	Metal lever, rubber roller	50	B	3SE5 000-0AA58	1	1 unit
	High-grade steel lever, plastic roller	19	B	3SE5 000-0AA52	1	1 unit
	High-grade steel lever, high-grade steel roller	19	B	3SE5 000-0AA53	1	1 unit
	Fork levers (for switches with snap-action contacts only)					
	2 metal levers, 2 plastic rollers	19	⊕ B	3SE5 000-0AT01	1	1 unit
	2 metal levers, 2 high-grade steel rollers	19	⊕ B	3SE5 000-0AT02	1	1 unit
	2 high-grade steel levers, 2 plastic rollers	19	⊕ B	3SE5 000-0AT03	1	1 unit
	2 high-grade steel levers, 2 high-grade steel rollers	19	⊕ B	3SE5 000-0AT04	1	1 unit
	Rod actuators, type D acc. to EN 50041					
	Aluminum rod, length 200 mm	6	B	3SE5 000-0AA80	1	1 unit
	Spring rod, length 200 mm	6	B	3SE5 000-0AA81	1	1 unit
	Plastic rod, length 200 mm	6	B	3SE5 000-0AA82	1	1 unit

⊕ Positively driven actuator, necessary in safety circuits.

¹⁾ Can be clinch mounted (turned through 180°, rear of lever).

Limit Switches

SIRIUS 3SE5 International Limit Switches

Metal enclosures
Enclosure width 56 mm, XL

1
2
3
4
5
6
7
8
9
10
11
12
13

Selection and ordering data

Complete units

4 or 5 contacts · Degree of protection IP66/IP67 · Cable entry 3 × (M20 × 1.5)

Version	Contacts	LEDs	DT	Complete units	PU (UNIT, SET, M)	PS*
				<input type="checkbox"/>		
						
				Order No.	Price per PU	

Complete units¹⁾ · Enclosure width 56 mm, XL



Plain plunger

Plain plungers

With high-grade steel plunger

Snap-action contacts 2 × (1 NO + 1 NC) —  B 3SE5 162-0CB01 1 1 unit



Rounded plunger

Rounded plungers

With high-grade steel plungers, with 3 mm overtravel

Slow-action contacts 1 NO + 1 NC and  B 3SE5 162-0EC02 1 1 unit
 Slow-action contacts with make-before-break 1 NO + 2 NC
 2 mm travel difference



Roller plunger

Roller plungers

With high-grade steel roller 13 mm, with 3 mm overtravel

Slow-action contacts 2 × (1 NO + 1 NC) —  B 3SE5 162-0BD02 1 1 unit
 Snap-action contacts 2 × (1 NO + 1 NC) —  A 3SE5 162-0CD02 1 1 unit



Roller lever

Roller levers

With metal lever and plastic roller 22 mm

Slow-action contacts 2 × (1 NO + 1 NC) —  B 3SE5 162-0BE01 1 1 unit
 Snap-action contacts 2 × (1 NO + 1 NC) —  A 3SE5 162-0CE01 1 1 unit

With metal lever and high-grade steel roller 22 mm

Snap-action contacts 2 × (1 NO + 1 NC) —  B 3SE5 162-0CE02 1 1 unit



Angular roller lever

Angular roller levers

With metal lever and plastic roller 22 mm

Snap-action contacts 2 × (1 NO + 1 NC) —  B 3SE5 162-0CF01 1 1 unit



Twist lever

Twist levers

With metal lever 27 mm and plastic roller 19 mm

Snap-action contacts 2 × (1 NO + 1 NC) —  A 3SE5 162-0CH01 1 1 unit

 For online configurator see www.siemens.com/sirius/configurators.

 Positive opening according to IEC 60947-5-1, Appendix K.

¹⁾ Popular versions.

Note:

If the device you require is not available as a complete unit, see "Modular System", page 13/40.

Limit Switches

SIRIUS 3SE5 International Limit Switches

Metal enclosures
Enclosure width 56 mm, XL

Modular system

4 or 6 contacts · Degree of protection IP66/IP67 · Cable entry 3 × (M20 × 1.5)

Version	Contacts	LEDs	DT	Modular system	PU (UNIT, SET, M)	PS*
				Order No.	Price per PU	

Basic switches · Enclosure width 56 mm, XL



Basic switch

Version	Contacts	LEDs	DT	Modular system	PU (UNIT, SET, M)	PS*
With 3 x M20 x 1.5 connecting thread						
Slow-action contacts	2 × (1 NO + 1 NC)	—	⊕ ▶	3SE5 162-0BA00	1	1 unit
Snap-action contacts	2 × (1 NO + 1 NC)	—	⊕ A	3SE5 162-0CA00	1	1 unit
Slow-action contacts with make-before-break	2 × (1 NO + 2 NC)	—	⊕ A	3SE5 162-0DA00	1	1 unit
With increased corrosion protection¹⁾						
Slow-action contacts	2 × (1 NO + 1 NC)	—	⊕ B	3SE5 162-0BA00-1CA0	1	1 unit
Snap-action contacts	2 × (1 NO + 1 NC)	—	⊕ B	3SE5 162-0CA00-1CA0	1	1 unit
Slow-action contacts with make-before-break	2 × (1 NO + 2 NC)	—	⊕ B	3SE5 162-0DA00-1CA0	1	1 unit

For online configurator see www.siemens.com/sirius/configurators.

Positive opening according to IEC 60947-5-1, Appendix K, or positively driven actuator, necessary in safety circuits.

¹⁾ Use corresponding high-grade steel lever.

Note:

Selection aid [see page 13/9](#).

Version	Diameter	DT	Modular system	PU (UNIT, SET, M)	PS*
	mm		Order No.	Price per PU	

Operating mechanisms



Plain plunger

Plain plungers						
High-grade steel plungers	10	⊕ A	3SE5 000-0AB01	1	1 unit	



Rounded plunger

Rounded plungers, type B acc. to EN 50041						
High-grade steel plungers, with 3 mm overtravel	10	⊕ B	3SE5 000-0AC02	1	1 unit	



Roller plunger

Roller plungers, type C acc. to EN 50041						
High-grade steel roller, with 3 mm overtravel	13	⊕ B	3SE5 000-0AD02	1	1 unit	



Roller lever

Roller levers						
Metal lever, plastic roller	22	⊕ A	3SE5 000-0AE01	1	1 unit	
Metal lever, high-grade steel roller	22	⊕ B	3SE5 000-0AE02	1	1 unit	
High-grade steel lever, plastic roller	22	⊕ B	3SE5 000-0AE03	1	1 unit	
High-grade steel lever, high-grade steel roller	22	⊕ B	3SE5 000-0AE04	1	1 unit	



Angular roller lever

Angular roller levers						
Metal lever, plastic roller	22	⊕ A	3SE5 000-0AF01	1	1 unit	
Metal lever, high-grade steel roller	22	⊕ B	3SE5 000-0AF02	1	1 unit	
High-grade steel lever, plastic roller	22	⊕ B	3SE5 000-0AF03	1	1 unit	
High-grade steel lever, high-grade steel roller	22	⊕ B	3SE5 000-0AF04	1	1 unit	



Spring rod

Spring rods (for switches with snap-action contacts only)						
Plastic plunger and high-grade steel spring:	7					
• Length 142.5 mm (spring 50 mm, plunger 50 mm)		B	3SE5 000-0AR01	1	1 unit	
• Length 76 mm (spring 23.5 mm, plunger 10 mm)		B	3SE5 000-0AR03	1	1 unit	
• Length 242.5 mm (spring 150 mm, plunger 50 mm)		B	3SE5 000-0AR04	1	1 unit	
High-grade steel plunger and spring:	7					
• Length 142.5 mm (spring 50 mm, plunger 50 mm)		B	3SE5 000-0AR02	1	1 unit	





Positively driven actuator, necessary in safety circuits.

Limit Switches

SIRIUS 3SE5 International Limit Switches

Metal enclosures
Enclosure width 56mm and 56mm, XL

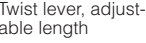
1
2
3
4
5
6
7
8
9
10
11
12
13

Version	Diameter	DT	Modular system	PU (UNIT, SET, M)	PS*	
	mm		Order No.	Price per PU		
Twist actuators						
	Twist actuators, metal (without lever)					
	<ul style="list-style-type: none"> For twist levers and rod actuators, switching right and/or left, adjustable For fork levers, latching 	<ul style="list-style-type: none"> ⊕ A ⊕ B 	<ul style="list-style-type: none"> 3SE5 000-0AH00 3SE5 000-0AT10 	<ul style="list-style-type: none"> 1 1 	<ul style="list-style-type: none"> 1 unit 1 unit 	
Levers for twist actuators						
	Twist levers 27 mm, offset, type A acc. to EN 50041					
	Metal lever, plastic roller	19	⊕ A	3SE5 000-0AA01	1	1 unit
	Metal lever, high-grade steel roller	19	⊕ A	3SE5 000-0AA02	1	1 unit
	Metal lever, roller with ball bearing	19	⊕ B	3SE5 000-0AA03	1	1 unit
	Metal lever, 2 plastic rollers	19	⊕ B	3SE5 000-0AA04	1	1 unit
	Metal lever, plastic roller	30	⊕ B	3SE5 000-0AA05	1	1 unit
	Metal lever, plastic roller	50	⊕ B	3SE5 000-0AA07	1	1 unit
	Metal lever, rubber roller	50	⊕ B	3SE5 000-0AA08	1	1 unit
	High-grade steel lever, plastic roller	19	⊕ B	3SE5 000-0AA11	1	1 unit
	High-grade steel lever, high-grade steel roller	19	⊕ B	3SE5 000-0AA12	1	1 unit
	Twist levers 35 mm, offset					
	Metal lever, plastic roller	19	⊕ B	3SE5 000-0AA15	1	1 unit
	Twist levers 30 mm, straight¹⁾					
Metal lever, plastic roller	19	⊕ B	3SE5 000-0AA24	1	1 unit	
Metal lever, plastic roller	30	⊕ B	3SE5 000-0AA26	1	1 unit	
	Twist levers, adjustable length, with grid hole					
	Metal lever, plastic roller	19	⊕ B	3SE5 000-0AA60	1	1 unit
	Metal lever, high-grade steel roller	19	⊕ B	3SE5 000-0AA61	1	1 unit
	Metal lever, plastic roller	50	⊕ B	3SE5 000-0AA67	1	1 unit
	Metal lever, rubber roller	50	⊕ B	3SE5 000-0AA68	1	1 unit
	High-grade steel lever, plastic roller	19	⊕ B	3SE5 000-0AA62	1	1 unit
	High-grade steel lever, high-grade steel roller	19	⊕ B	3SE5 000-0AA63	1	1 unit
	Twist levers, adjustable length					
	Metal lever, plastic roller	19	A	3SE5 000-0AA50	1	1 unit
	Metal lever, high-grade steel roller	19	B	3SE5 000-0AA51	1	1 unit
	Metal lever, plastic roller	30	B	3SE5 000-0AA55	1	1 unit
	Metal lever, plastic roller	50	B	3SE5 000-0AA57	1	1 unit
	Metal lever, rubber roller	50	B	3SE5 000-0AA58	1	1 unit
	High-grade steel lever, plastic roller	19	B	3SE5 000-0AA52	1	1 unit
	High-grade steel lever, high-grade steel roller	19	B	3SE5 000-0AA53	1	1 unit
	Fork levers (for switches with snap-action contacts only)					
	2 metal levers, 2 plastic rollers	19	⊕ B	3SE5 000-0AT01	1	1 unit
	2 metal levers, 2 high-grade steel rollers	19	⊕ B	3SE5 000-0AT02	1	1 unit
	2 high-grade steel levers, 2 plastic rollers	19	⊕ B	3SE5 000-0AT03	1	1 unit
	2 high-grade steel levers, 2 high-grade steel rollers	19	⊕ B	3SE5 000-0AT04	1	1 unit
	Rod actuators, type D acc. to EN 50041					
	Aluminum rod, length 200 mm	6	B	3SE5 000-0AA80	1	1 unit
	Spring rod, length 200 mm	6	B	3SE5 000-0AA81	1	1 unit
	Plastic rod, length 200 mm	6	B	3SE5 000-0AA82	1	1 unit
	Plastic rod, length 330 mm	6	B	3SE5 000-0AA83²⁾	1	1 unit

⊕ Positively driven actuator, necessary in safety circuits.

¹⁾ Can be clinch mounted (turned through 180°, rear of lever).

²⁾ For Enclosure width 56mm XL only.

Limit Switches

SIRIUS 3SE5 International Limit Switches

3SE5, metal enclosures
Ambient temperature to -40 °C

Selection and ordering data

Modular system

2 or 3 contacts · Degree of protection IP66/IP67 · Cable entry M20 × 1.5

Version	Contacts	LEDs	DT	Modular system		PU (UNIT, SET, M)	PS*
				Order No.	Price per PU		

Basic switches · Enclosure width 31 mm (with rounded plunger¹⁾)



Basic switch

With plunger

Snap-action contacts	1 NO + 1 NC	—		B	3SE5 212-0CC05-1AJ0	1	1 unit
Slow-action contacts	1 NO + 2 NC	—		B	3SE5 212-0KC05-1AJ0	1	1 unit
Snap-action contacts	1 NO + 2 NC	—		B	3SE5 212-0LC05-1AJ0	1	1 unit

For online configurator see www.siemens.com/sirius/configurators.

Positive opening according to IEC 60947-5-1, Appendix K, or positively driven actuator, necessary in safety circuits.

¹⁾ For enclosures with widths of 31 mm, the basic switch is a complete unit with rounded plungers.

Note:

Selection aid [see page 13/9](#).

Version	Diameter	DT	Modular system		PU (UNIT, SET, M)	PS*
	mm					
			Order No.	Price per PU		

Operating mechanisms



Roller plunger

Roller plungers, type C acc. to EN 50047

Plastic rollers	10		B	3SE5 000-0AD03-1AJ0	1	1 unit
-----------------	----	--	---	----------------------------	---	--------



Roller lever

Roller levers, type E acc. to EN 50047

Metal lever, plastic roller	13		B	3SE5 000-0AE10-1AJ0	1	1 unit
High-grade steel lever, plastic roller	13		B	3SE5 000-0AE12-1AJ0	1	1 unit



Angular roller lever

Angular roller levers

Metal lever, plastic roller	13		B	3SE5 000-0AF10-1AJ0	1	1 unit
High-grade steel lever, plastic roller	13		B	3SE5 000-0AF12-1AJ0	1	1 unit

Twist actuators



Twist actuator

Twist actuators, plastic (without lever)

Switching right and/or left, adjustable			B	3SE5 000-0AK00-1AJ0	1	1 unit
---	--	--	---	----------------------------	---	--------

Levers for twist actuators



Twist lever

Twist lever straight, 21 mm, type A acc. to EN 50047

Metal lever, plastic roller	19		B	3SE5 000-0AA21-1AJ0	1	1 unit
High-grade steel lever, plastic roller	19		B	3SE5 000-0AA31-1AJ0	1	1 unit



Twist lever, adjustable length

Twist levers, adjustable length, with grid hole

Metal lever, plastic roller	19		B	3SE5 000-0AA60-1AJ0	1	1 unit
High-grade steel lever, plastic roller	19		B	3SE5 000-0AA62-1AJ0	1	1 unit

Positively driven actuator, necessary in safety circuits.

Limit Switches

SIRIUS 3SE5 International Limit Switches

3SE5, metal enclosures
Ambient temperature to -40 °C

Complete units

2 or 3 contacts · Degree of protection IP66/IP67 · Cable entry M20 × 1.5

Version	Contacts	LEDs	DT	Complete units	Configurator	Order No.	Price per PU	PU (UNIT, SET, M)	PS*

Complete units · Enclosure width 40 mm



Rounded plunger

Rounded plungers, type B acc. to EN 50041

With high-grade steel plungers, with 3 mm overtravel

Snap-action contacts	1 NO + 1 NC	—	⊕ B	3SE5 112-0CC02-1AJ0	1	1 unit
----------------------	-------------	---	-----	---------------------	---	--------



Twist lever, adjustable length

Twist levers, adjustable length

With high-grade steel lever with grid hole and plastic roller 19 mm

Snap-action contacts	1 NO + 1 NC	—	⊕ B	3SE5 112-0CH62-1AJ0	1	1 unit
----------------------	-------------	---	-----	---------------------	---	--------

For online configurator see www.siemens.com/sirius/configurators.

⊕ Positive opening according to IEC 60947-5-1, Appendix K or positively driven actuator, necessary in safety circuits.

Note:

If the device you require is not available as a complete unit, see "Modular System".

Modular system

2, 3 or 4 contacts · Degree of protection IP66/IP67 · Cable entry M20 × 1.5

Version	Contacts	LEDs	DT	Modular system	Configurator	Order No.	Price per PU	PU (UNIT, SET, M)	PS*

Basic switches · Enclosure width 40 mm



Basic switch

With M20 □ 1.5 connecting thread

Snap-action contacts	1 NO + 1 NC	—	⊕ B	3SE5 112-0CA00-1AJ0	1	1 unit
Slow-action contacts	1 NO + 2 NC	—	⊕ B	3SE5 112-0KA00-1AJ0	1	1 unit
Snap-action contacts	1 NO + 2 NC	—	⊕ B	3SE5 112-0LA00-1AJ0	1	1 unit

Basic switches · Enclosure width 56 mm



Basic switch

With 3 x M20 x 1.5 connecting thread

Snap-action contacts	1 NO + 1 NC	—	⊕ B	3SE5 122-0CA00-1AJ0	1	1 unit
Slow-action contacts	1 NO + 2 NC	—	⊕ B	3SE5 122-0KA00-1AJ0	1	1 unit
Snap-action contacts	1 NO + 2 NC	—	⊕ B	3SE5 122-0LA00-1AJ0	1	1 unit

Basic switches · Enclosure width 56 mm, XL



Basic switch

With 3 x M20 x 1.5 connecting thread

Slow-action contacts	2 × (1 NO + 1 NC)	—	⊕ B	3SE5 162-0BA00-1AJ0	1	1 unit
Snap-action contacts	2 × (1 NO + 1 NC)	—	⊕ B	3SE5 162-0CA00-1AJ0	1	1 unit

For online configurator see www.siemens.com/sirius/configurators.

⊕ Positive opening according to IEC 60947-5-1, Appendix K or positively driven actuator, necessary in safety circuits.







Note:

Selection aid [see page 13/9](#).

Limit Switches

SIRIUS 3SE5 International Limit Switches

3SE5, metal enclosures
Ambient temperature to -40 °C

Version	Diameter	DT	Modular system	PU (UNIT, SET, M)	PS*
	mm		Order No. Price per PU		
Operating mechanisms					
	Rounded plungers, type B acc. to EN 50041 High-grade steel plungers, with 3 mm overtravel	10	⊕ B	3SE5 000-0AC02-1AJ0	1 1 unit
Rounded plunger					
	Roller plungers, type C acc. to EN 50041 High-grade steel roller, with 3 mm overtravel	10	⊕ B	3SE5 000-0AD02-1AJ0	1 1 unit
Roller plunger					
Roller levers					
	Metal lever, plastic roller	13	⊕ B	3SE5 000-0AE01-1AJ0	1 1 unit
Roller lever	High-grade steel lever, plastic roller	13	⊕ B	3SE5 000-0AE03-1AJ0	1 1 unit
Angular roller levers					
	Metal lever, plastic roller	13	⊕ B	3SE5 000-0AF01-1AJ0	1 1 unit
Angular roller lever	High-grade steel lever, plastic roller	13	⊕ B	3SE5 000-0AF03-1AJ0	1 1 unit
Twist actuators					
	Twist actuators, metal (without lever) Switching right and/or left, adjustable		⊕ B	3SE5 000-0AH00-1AJ0	1 1 unit
Twist actuator					
Levers for twist actuators					
	Twist levers, type A acc. to EN 50041 Metal lever, plastic roller	19	⊕ B	3SE5 000-0AA01-1AJ0	1 1 unit
Twist lever	High-grade steel lever, plastic roller	19	⊕ B	3SE5 000-0AA11-1AJ0	1 1 unit
Twist levers, adjustable length, with grid hole					
	Metal lever, plastic roller	19	⊕ B	3SE5 000-0AA60-1AJ0	1 1 unit
Twist lever, adjustable length	High-grade steel lever, plastic roller	19	⊕ B	3SE5 000-0AA62-1AJ0	1 1 unit

⊕ Positively driven actuator, necessary in safety circuits.

Overview

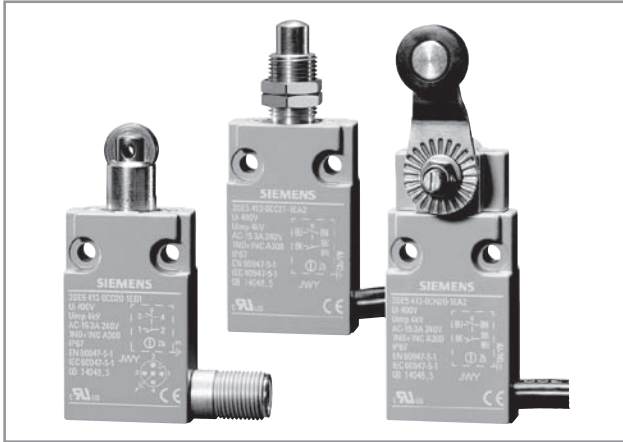

Compact design in width 30 mm

Particularly in harsh environments or on equipment with limited space, the small 3SE5 4 position switches in compact design with a depth of 16 mm and a weight of only 80 g (without cable) are ideal. Above all the versions with molded cable can be mounted in the most confined places.

3SE5 4 compact position switches are available in two different widths as complete units:

- The 3SE5 413 series complies with the EU standard and features a 30 mm wide enclosure with drilled holes at a distance of 20 mm.
- The 3SE5 423 series meets the requirements of the US market and features a 40 mm wide enclosure with drilled holes at a spacing of 25 mm.

Both the enclosure and the twist actuator are made of metal and comply with the high IP67 degree of protection. Following actuators are available:

- Rounded plungers
- Rounded plungers with central fixing
- Rounded plungers with external seal
- Roller plungers
- Roller plunger with central fixing
- Twist levers

The contact block is designed with snap-action contacts 1 NO + 1 NC. The NC contact complies with the requirements for positive opening acc. to IEC 60947-5-1.

Use in safety circuits up to Category 4 according to EN ISO 13849-1.

Connection:

- With molded cable, 2 m or 5 m long
- With M12 connector socket

Benefits

- Very compact yet with the same rating as the 3SE51 standard switches, for notable space savings in confined installation conditions
- Various actuator versions available
- Actuator heads rotatable in increments of 90°
- Time is saved when mounting the fully assembled unit
- With metal enclosure of degree of protection IP67, ideal for use in rough industrial environments
- Insensitive to electromagnetic interference

Limit Switches

SIRIUS 3SE5 International Limit Switches

3SE5, metal enclosures
Compact design

Selection and ordering data

2 snap-action contacts 1 NO + 1 NC · Degree of protection IP67 · With connecting cable or M12 connector socket

Operating mechanism	Enclosure width	DT	Configurator 	PU (UNIT, SET, M)	PS*
	mm		Order No. Price per PU		

Complete units · Enclosure width 30 or 40 mm

Rounded plungers

- Standard mounting
 - With 2 m cable 5 x 0.75 mm²
 - With 5 m cable 5 x 0.75 mm²
 - With M12 connector socket



Rounded plunger

- With central fixing M12 x 1
 - With 2 m cable 5 x 0.75 mm²



With central fixing

- With external seal
 - With 2 m cable 5 x 0.75 mm²



With external seal

Roller plungers

- Standard mounting
 - With 2 m cable 5 x 0.75 mm²
 - With 5 m cable 5 x 0.75 mm²
 - With M12 connector socket



Roller plunger

- With central fixing M12 x 1
 - With 2 m cable 5 x 0.75 mm²



With plug

- Actuator head rotated 90°
 - With 2 m cable 5 x 0.75 mm²



With plug, enclosure width 40 mm

Twist levers

- Standard mounting
 - With 2 m cable 5 x 0.75 mm²
 - With 5 m cable 5 x 0.75 mm²
 - With M12 connector socket



Twist lever

30	⊕ A	3SE5 413-0CC20-1EA2	1	1 unit
40	⊕ ▶	3SE5 423-0CC20-1EA2	1	1 unit
30	⊕ B	3SE5 413-0CC20-1EA5	1	1 unit
30	⊕ A	3SE5 413-0CC20-1EB1	1	1 unit
40	⊕ A	3SE5 423-0CC20-1EB1	1	1 unit
30	⊕ ▶	3SE5 413-0CC21-1EA2	1	1 unit
40	⊕ A	3SE5 423-0CC21-1EA2	1	1 unit
30	⊕ A	3SE5 413-0CC22-1EA2	1	1 unit
40	⊕ A	3SE5 423-0CC22-1EA2	1	1 unit
30	⊕ ▶	3SE5 413-0CD20-1EA2	1	1 unit
40	⊕ ▶	3SE5 423-0CD20-1EA2	1	1 unit
30	⊕ B	3SE5 413-0CD20-1EA5	1	1 unit
30	⊕ A	3SE5 413-0CD20-1EB1	1	1 unit
40	⊕ A	3SE5 423-0CD20-1EB1	1	1 unit
30	⊕ A	3SE5 413-0CD21-1EA2	1	1 unit
40	⊕ A	3SE5 423-0CD21-1EA2	1	1 unit
30	⊕ A	3SE5 413-0CD23-1EA2	1	1 unit
30	⊕ ▶	3SE5 413-0CN20-1EA2	1	1 unit
40	⊕ A	3SE5 423-0CN20-1EA2	1	1 unit
30	⊕ A	3SE5 413-0CN20-1EA5	1	1 unit
30	⊕ A	3SE5 413-0CN20-1EB1	1	1 unit
40	⊕ A	3SE5 423-0CN20-1EB1	1	1 unit

 For online configurator see www.siemens.com/sirius/configurators.

 Positive opening according to IEC 60947-5-1, Appendix K.

Limit Switches

SIRIUS 3SE5 International Limit Switches

3SE5, open-type design

1

2

3

4

5

6

7

8

9

10

11

12

13

Overview



Open-type design

Their compact design makes these switches particularly suitable for use in confined conditions. The fixing dimensions and operating points are according to EN 50047.

The switches are equipped with two or three contacts in slow-action or snap-action versions. The stroke is 6 mm.

The empty enclosure can be equipped with all switch block versions (see page 13/49).

Selection and ordering data

2 or 3 contacts · Degree of protection IP20 (2 contacts), IP10 (3 contacts)

Version	Contacts	DT	Configurator	Order No.	Price per PU	PU (UNIT, SET, M)	PS*
---------	----------	----	--------------	-----------	--------------	-------------------	-----

Plastic enclosures · Enclosure width 30 mm

With teflon plunger, Ø 6 mm



2 contacts

Slow-action contacts	1 NO + 1 NC	⊕ ▶	3SE5 250-0BC05			1	1 unit
Snap-action contacts	1 NO + 1 NC	⊕ ▶	3SE5 250-0CC05			1	1 unit



3 contacts

Slow-action contacts	1 NO + 2 NC	⊕ ▶	3SE5 250-0KC05			1	1 unit
Snap-action contacts	1 NO + 2 NC	⊕ ▶	3SE5 250-0LC05			1	1 unit
Slow-action contacts with make-before-break	1 NO + 2 NC	⊕ A	3SE5 250-0MC05			1	1 unit
Slow-action contacts	2 NO + 1 NC	⊕ ▶	3SE5 250-0PC05			1	1 unit



Empty enclosures

Empty enclosures without contact block	—	⊕ B	3SE5 250-0AC05			1	1 unit
--	---	-----	-----------------------	--	--	---	--------



2 contacts

Contact blocks with 2 contacts for open-type design¹⁾

• Slow-action contacts	1 NO + 1 NC	⊕ B	3SE5 050-0BA00			1	1 unit
• Snap-action contacts	1 NO + 1 NC	⊕ B	3SE5 050-0CA00			1	1 unit
- Standard		⊕ B	3SE5 050-0GA00			1	1 unit
- 2 × 2 mm switching interval		⊕ B	3SE5 050-0GA00			1	1 unit
- Short stroke		⊕ B	3SE5 050-0NA00			1	1 unit

⚙ For online configurator see www.siemens.com/sirius/configurators.

⊕ Positive opening according to IEC 60947-5-1, Appendix K.

¹⁾ Contact blocks with 3 contacts see page 13/49.

Limit Switches

SIRIUS 3SE5 International Limit Switches

Accessories

Selection and ordering data

Version	DT	Order No.	List Price \$ per PU	PU (UNIT, SET, M)	PS*	PG	Weight per PU approx. kg
Plug-in connections for M20 × 1.5 connecting threads							
		Connector sockets (6-pole+PE), for M20×1.5		1	1 unit	102	0.030
		For max. 250 V, 10 A					
		With 0.75 mm ² connecting cable, plastic, degree of protection IP65, ambient temperature -40 to +90 °C					
		Cable boxes (6-pole + PE)¹⁾		1	1 unit	102	0.065
		With terminal compartment, can be pre-assembled, plastic, degree of protection IP65					
		Connector sockets (4-pole), M12, for M20 × 1.5, fixed		1	1 unit	102	0.010
		For max 250 V, 4 A, U _{imp} = 2500 V					
		With four 0.25 mm ² connecting cables, plastic, degree of protection IP67, ambient temperature -40 to +85 °C					
		Cable boxes (4-pole), M12, with terminal compartment, can be pre-assembled		1	1 unit	574	0.015
		Angular cable boxes (4-pole), M12, with terminal compartment, can be pre-assembled		1	1 unit	574	0.015
		Connector sockets (5-pole), M12, for M20 × 1.5, fixed		1	1 unit	102	0.010
		For max 125 V, 4 A, U _{imp} = 1500 V					
		With five 0.25 mm ² connecting cables, plastic, degree of protection IP67, ambient temperature -40 to +85 °C					
		Cable boxes (5-pole), M12, with terminal compartment, can be pre-assembled		1	1 unit	574	0.016
		Angular cable boxes (5-pole), M12, with terminal compartment, can be pre-assembled		1	1 unit	574	0.016
		Connector sockets (8-pole), M12, for M20 × 1.5, fixed, metal version		1	1 unit	102	0.025
		For max 30 V, 2 A, U _{imp} = 800 V					
		With eight 0.25 mm ² connecting cables, metal, degree of protection IP67, ambient temperature -40 to +85 °C					
		Cable boxes (8-pole), M12		1	1 unit	574	0.335
		With 5 m PUR cable, 8 × 0.25 mm ² , IP67					
Adaptors for 3SE. (with M 16)							
		metal M16 x 1.5 to 1/2" NPT		1	1 unit		0.022
Adaptors for 3SE2 (with M 20)							
		plastic M20 x 1.5 wire gland		1	1 unit		0.011
		metal M20 x 1.5 to 1/2" NPT		1	1 unit		0.022
		plastic M20 x 1.5 to 1/2" NPT		1	1 unit		0.012
							
		plastic cable gland, M20 x 1.5		1	1 unit		0.010
Adaptors for 3SE. (with M 25)							
		metal M 25 x 1.5 to 1/2" NPT		1	1 unit		0.022







¹⁾ For wiring, a crimping tool is necessary, max. conductor cross-section 1 mm².

Limit Switches

SIRIUS 3SE5 International Limit Switches

Accessories and spare parts

1
2
3
4
5
6
7
8
9
10
11
12
13

Version	Color/ contacts	DT	Order No.	Price per PU	PU (UNIT, SET, M)	PS*
Optional accessories for 3SE52						
	Protective caps, rubber, for rounded plungers acc. to EN 50047, 3SE5 ...-...C05	Black	A	3SE5 000-0AC30	1	1 unit
Spare parts for 3SE51, 3SE52						
	Empty enclosures, plastic	Turquoise				
	Enclosure width 31 mm		B	3SE5 232-0AC05	1	1 unit
	• With increased corrosion protection		B	3SE5 232-0AC05-1CA0	1	1 unit
	Enclosure width 50 mm		B	3SE5 242-0AC05	1	1 unit
	• With increased corrosion protection		B	3SE5 242-0AC05-1CA0	1	1 unit
Enclosure width 31 mm						
	Empty enclosures, metal	Turquoise				
	Enclosure width 31 mm		B	3SE5 212-0AC05	1	1 unit
	• With increased corrosion protection		B	3SE5 212-0AC05-1CA0	1	1 unit
	Enclosure width 40 mm		B	3SE5 112-0AA00	1	1 unit
	• With increased corrosion protection		B	3SE5 112-0AA00-1CA0	1	1 unit
	Enclosure width 56 mm		B	3SE5 122-0AA00	1	1 unit
	• With increased corrosion protection		B	3SE5 122-0AA00-1CA0	1	1 unit
Enclosure width 56 mm, XL ¹⁾		B	3SE5 162-0AA00	1	1 unit	
	Contact blocks with 2 contacts²⁾					
	• Slow-action contacts	1 NO + 1 NC	⊕ ▶	3SE5 000-0BA00	1	1 unit
	• Snap-action contacts	1 NO + 1 NC				
	- Standard		⊕ B	3SE5 000-0CA00	1	1 unit
	- Gold-plated contacts		⊕ B	3SE5 000-0CA00-1AC1	1	1 unit
	- 2 x 2 mm switching interval		⊕ B	3SE5 000-0GA00	1	1 unit
- Short stroke		⊕ B	3SE5 000-0NA00	1	1 unit	
	Contact blocks with 3 contacts					
	• Slow-action contacts	1 NO + 2 NC	⊕ B	3SE5 000-0KA00	1	1 unit
	• Snap-action contacts	1 NO + 2 NC	⊕ B	3SE5 000-0LA00	1	1 unit
	• Slow-action contacts with make-before-break	1 NO + 2 NC	⊕ A	3SE5 000-0MA00	1	1 unit
• Slow-action contacts	2 NO + 1 NC	A	3SE5 000-0PA00	1	1 unit	
	Contact blocks for enclosure XL¹⁾					
	• Slow-action contacts	1 NO + 1 NC	⊕ B	3SE5 060-0BA00	1	1 unit
	• Snap-action contacts	1 NO + 1 NC	⊕ B	3SE5 060-0CA00	1	1 unit
	• Slow-action contacts with make-before-break	1 NO + 2 NC	⊕ B	3SE5 060-0MA00	1	1 unit

⊕ Positive opening according to IEC 60947-5-1, Appendix K.







1) Equip XL enclosures only with contact combinations according to pages 12/11, 12/42 and 12/43.

2) Unsuitable for open-type position switches; see page 13/47.

Limit Switches

SIRIUS 3SE5 International Limit Switches

Accessories and spare parts

Version	Rated voltage LED	DT	Order No.	Price per PU	PU (UNIT, SET, M)	PS*
V						
Spare parts for 3SE51, 3SE52						
 31 mm, turquoise with LED	Covers for plastic enclosures, width 31 mm					
	• Turquoise with LED	24 DC	B	3SE5 230-1AA00		1 1 unit
		230 AC	B	3SE5 230-3AA00		1 1 unit
	• Yellow	—	B	3SE5 230-0AA00-1AG0		1 1 unit
	• Yellow with LED	24 DC	B	3SE5 230-1AA00-1AG0		1 1 unit
		230 AC	B	3SE5 230-3AA00-1AG0		1 1 unit
 40 mm, yellow with LED	Covers for plastic enclosures, width 40 mm					
	• Turquoise with LED	24 DC	B	3SE5 130-1AA00		1 1 unit
		230 AC	B	3SE5 130-3AA00		1 1 unit
	• Yellow	—	B	3SE5 130-0AA00-1AG0		1 1 unit
	• Yellow with LED	24 DC	B	3SE5 130-1AA00-1AG0		1 1 unit
		230 AC	B	3SE5 130-3AA00-1AG0		1 1 unit
 50 mm, turquoise with LED	Covers for plastic enclosures, width 50 mm					
	• Turquoise with LED	24 DC	B	3SE5 240-1AA00		1 1 unit
		230 AC	B	3SE5 240-3AA00		1 1 unit
	• Yellow	—	B	3SE5 240-0AA00-1AG0		1 1 unit
	• Yellow with LED	24 DC	B	3SE5 240-1AA00-1AG0		1 1 unit
		230 AC	B	3SE5 240-3AA00-1AG0		1 1 unit
 31 mm, turquoise with LED	Covers for metal enclosures, width 31 mm					
	• Turquoise with LED	24 DC	B	3SE5 210-1AA00		1 1 unit
		230 AC	B	3SE5 210-3AA00		1 1 unit
	• Yellow	—	B	3SE5 210-0AA00-1AG0		1 1 unit
	• Yellow with LED	24 DC	B	3SE5 210-1AA00-1AG0		1 1 unit
		230 AC	B	3SE5 210-3AA00-1AG0		1 1 unit
 40 mm, yellow with LED	Covers for metal enclosures, width 40 mm					
	• Turquoise with LED	24 DC	B	3SE5 110-1AA00		1 1 unit
		230 AC	B	3SE5 110-3AA00		1 1 unit
	• Yellow	—	B	3SE5 110-0AA00-1AG0		1 1 unit
	• Yellow with LED	24 DC	B	3SE5 110-1AA00-1AG0		1 1 unit
		230 AC	B	3SE5 110-3AA00-1AG0		1 1 unit
 56 mm, yellow with LED	Covers for metal enclosures, width 56 mm					
	• Turquoise with LED	24 DC	B	3SE5 120-1AA00		1 1 unit
		230 AC	B	3SE5 120-3AA00		1 1 unit
	• Yellow	—	B	3SE5 120-0AA00-1AG0		1 1 unit
	• Yellow with LED	24 DC	B	3SE5 120-1AA00-1AG0		1 1 unit
		230 AC	B	3SE5 120-3AA00-1AG0		1 1 unit
Covers for XL metal enclosures, width 56 mm						
• Yellow	—	B	3SE5 160-0AA00-1AG0		1 1 unit	

Technical specifications

Type	3SE5 1..., 3SE5 2..		3SE5 41.		3SE5 42.	
General data						
Standards	IEC 60947-5-1, EN 60947-5-1					
Rated insulation voltage U_i	V	400		400		
Pollution degree acc. to IEC 60664-1		Class 3		Class 3		
Rated impulse withstand voltage U_{imp}	kV	6		4		
Rated operational voltage U_e	V	400 V AC, over 300 V AC only for equal potential ¹⁾		300 AC		
Conventional thermal current I_{th}	A	10		6		10
Rated operational current I_e		2-pole		3-pole		2-pole
• With alternating current 50/60 Hz		$I_e/AC-15$		$I_e/AC-15$		$I_e/AC-15$
- At 24 V	A	6		6		6
- At 120 V	A	6		3		6
- At 240 V	A	3		1.5		3
• For direct current		$I_e/DC-13$		$I_e/DC-13$		$I_e/DC-13$
- At 24 V	A	3		3		3
- At 125 V	A	0.55		0.55		0.55
- At 250 V	A	0.27		0.27		0.27
Short-circuit protection²⁾						
• With DIAZED fuse links, gG operational class	A	6				
• With miniature circuit breaker, Char. C	A	1		2		1
Mechanical endurance						
• Basic switches		15 × 10 ⁶ operating cycles		30 × 10 ⁶ operating cycles		30 × 10 ⁶ operating cycles
• With spring rod, 3SE5 ...-...R..		10 × 10 ⁶ operating cycles		—		—
• With fork lever 3SE5 1...-...T..		1 × 10 ⁶ operating cycles		—		—
Electrical endurance						
• With 3RH.1, 3RT contactors in size S00, S0		10 × 10 ⁶ operating cycles		10 × 10 ⁶ operating cycles		5 × 10 ⁶ operating cycles
• For utilization category AC-15 when switching off $I_e/AC-15$ at 240 V		0.1 × 10 ⁶ operating cycles		—		—
• With utilization category DC-12/DC-13		For direct current depending on the loading of the switch				
Switching frequency		6000 operating cycles/h		1800 operating cycles/h		
With 3RH.1, 3RT contactors in size S00, S0						
Switching accuracy	mm	0.05				
For repeated switching, measured at the plunger of the contact block						
• With twist actuators		1°				
Rated data acc. to \mathcal{E}, \mathcal{R} and \mathcal{V}						
• Rated voltage	V	300				
• Uninterrupted current	A	6				
• Switching capacity		Heavy duty, A 300 / B 300 / Q 300		A 300 / Q 300		

¹⁾ For slow-action contacts 1 NO + 2 NC with make-before-break and 2 NO + 1 NC the following applies: over 250 V AC only equal potential

²⁾ Without any welds according to IEC 60947-5-1.

Type	3SE5 23.	3SE5 13	3SE5 24.	3SE5 21.	3SE5 11.	3SE5 12., 3SE5 16.	3SE5 4..	3SE5 25.
Enclosure								
Enclosure								
• Material	Ultramid A3X2G7			Zinc diecasting GD Zn Al4 Cu1			—	
• Width	mm	31	40	50	31	40	56	30 / 40
Degree of protection acc. to IEC 60529		IP65	IP66/IP67 ¹⁾		IP67		IP20, IP10	
Ambient temperature								
• During operation	°C	-25 ... +85			-25 ... +85		-25 ... +85	
• In operation, switch with LEDs	°C	-25 ... +70			—		—	
• Storage, transport	°C	-40 ... +90			-40 ... +90		-40 ... +90	
Mounting position		Any						
Connection								
Cable entry		1 × (M20 × 1.5)		2 × (M20 × 1.5)		1 × (M20 × 1.5)		3 × (M20 × 1.5)
Conductor cross-sections²⁾								
• Solid	mm ²	2 × (0.5 ... 0.75), 1 × (0.5 ... 1.5)						
• Finely stranded with end sleeve	mm ²	2 × (0.5 ... 1.5)						
Tightening torque , contact block	Nm	0.8 ... 1.0						
Protective conductor connection inside enclosure		—			M3.5		—	

¹⁾ For twist actuators with spring rod and rod actuators: IP65/IP67.

²⁾ For the maximum number of connectable conductors for the respective contact block see operating instructions.

Limit Switches

SIRIUS 3SE5 International Limit Switches

3SE5, plastic enclosures
Enclosure widths 31 mm and 50 mm

Configuration

Actuation and operating travel (angle) for enclosure width 31 mm and 50 mm

Operation by bar (standard)		Slow-action contacts		Snap-action contacts									
<ul style="list-style-type: none"> ○ Operating point acc. to EN 50047 (snap-action) * Operating point on return (snap-action) ⊕ Positive opening acc. to EN 60947-5-1 → Direction of operation v_{max} Max. actuating speed ■ Contact closed □ Contact open 	<p>1 NO + 1 NC</p> <p>Ident. No. 11</p>	<p>1 NO + 2 NC</p> <p>Ident. No. 12</p>	<p>1 NO + 1 NC</p> <p>Ident. No. 11</p>	<p>1 NO + 2 NC</p> <p>Ident. No. 12</p>									
<p>Rounded plungers, type B</p> <p>3SE5 2...-C05</p> <p>$v_{max} = 1 \text{ m/s}$ Minimum force required in direction of operation: 18 N</p>		<p>Actuation along plunger axis</p> <p>-BC05</p> <p>Ident. No. NSCO_00831a</p>		<p>Actuation along plunger axis</p> <p>-KC05</p> <p>Ident. No. NSCO_00833a</p>		<p>Actuation along plunger axis</p> <p>-CC05, -HC05</p> <p>Ident. No. NSCO_00832a</p>		<p>Actuation along plunger axis</p> <p>-FC05</p> <p>Ident. No. NSCO_00835a</p>		<p>Actuation along plunger axis</p> <p>-GC05</p> <p>Ident. No. NSCO_00836a</p>		<p>Actuation along plunger axis</p> <p>-LC05</p> <p>Ident. No. NSCO_00834a</p>	
<p>Angular roller levers</p> <p>3SE5 2...-F1</p> <p>$v_{max} = 1 \text{ m/s}$ Minimum force required in direction of operation: 9 N</p>		<p>Actuation along plunger axis</p> <p>-BF10</p> <p>Ident. No. NSCO_00857a</p>		<p>Actuation along plunger axis</p> <p>-KF10</p> <p>Ident. No. NSCO_00858a</p>		<p>Actuation along plunger axis</p> <p>-HF10</p> <p>Ident. No. NSCO_00858a</p>		<p>Actuation along plunger axis</p> <p>-FC05 + head¹⁾</p> <p>Ident. No. NSCO_00843</p>		<p>Actuation along plunger axis</p> <p>-GC05 + head¹⁾</p> <p>Ident. No. NSCO_00858a</p>		<p>Actuation along plunger axis</p> <p>-LF10</p> <p>Ident. No. NSCO_00860a</p>	
<p>Operation by bar (standard)</p> <ul style="list-style-type: none"> ○ Operating point acc. to EN 50047 (snap-action) * Operating point on return (snap-action) ⊕ Positive opening acc. to EN 60947-5-1 → Direction of operation v_{max} Max. actuating speed ■ Contact closed □ Contact open 		<p>Slow-action contacts</p> <ul style="list-style-type: none"> ■ Contact closed □ Contact open 		<p>Snap-action contacts</p> <ul style="list-style-type: none"> ■ Contact closed □ Contact open 									
<p>Roller plungers</p> <p>3SE5 2...-D03, -D04 3SE5 2...-D10, -D11</p> <p>Form C Central fixing</p> <p>$v_{max} = 1 \text{ m/s}$ Minimum force required in direction of operation: 18 N</p>		<p>Lateral actuation</p> <p>1 NO + 1 NC</p> <p>Ident. No. 11</p>		<p>Lateral actuation</p> <p>3SE5 2...-BD03</p> <p>Ident. No. NSCO_00837a</p>		<p>Lateral actuation</p> <p>1 NO + 1 NC</p> <p>Ident. No. 11</p>		<p>Lateral actuation</p> <p>3SE5 2...-HD03, -HD10</p> <p>Ident. No. NSCO_00838a</p>					
		<p>Lateral actuation</p> <p>1 NO + 2 NC</p> <p>Ident. No. 12</p>		<p>Lateral actuation</p> <p>3SE5 2...-KD03, -KD10</p> <p>Ident. No. NSCO_00839a</p>		<p>Lateral actuation</p> <p>1 NO + 2 NC</p> <p>Ident. No. 12</p>		<p>Lateral actuation</p> <p>3SE5 2...-FC05 + head¹⁾</p> <p>Ident. No. NSCO_00841</p>		<p>Lateral actuation</p> <p>3SE5 2...-LD03</p> <p>Ident. No. NSCO_00840a</p>			

¹⁾ The basic switch and actuator head/actuator head must be ordered separately.





Limit Switches

SIRIUS 3SE5 International Limit Switches

3SE5, plastic enclosures
Enclosure widths 31 mm and 50 mm

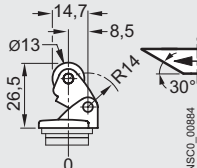
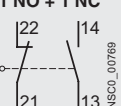
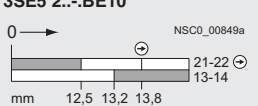
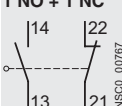
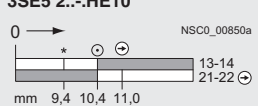
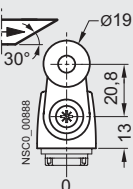
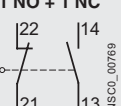
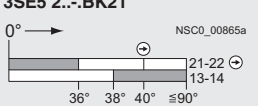
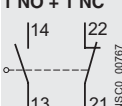
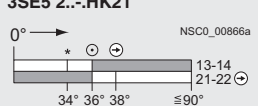
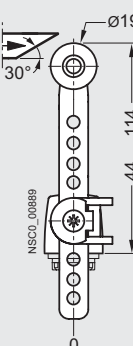
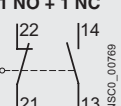
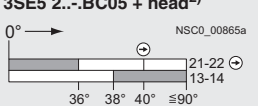
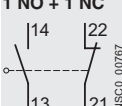
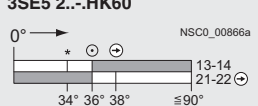
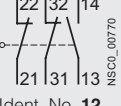
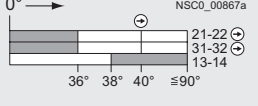
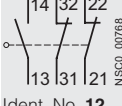
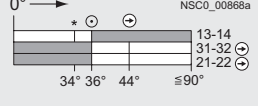
Configuration

Actuation and operating travel (angle) for enclosure width 31 mm and 50 mm

Operation by bar (standard) ○ Operating point acc. to EN 50047 (snap-action) * Operating point on return (snap-action) ⊕ Positive opening acc. to EN 60947-5-1 → Direction of operation v _{max} Max. actuating speed	Slow-action contacts ■ Contact closed □ Contact open	Snap-action contacts ■ Contact closed □ Contact open
Roller levers, type E 3SE5 2...-E1.  <p>v_{max} = 1 m/s Minimum force required in direction of operation: 9 N</p>	Lateral actuation 1 NO + 1 NC  3SE5 2...-BE10  <p>Ident. No. 11</p>	Lateral actuation 1 NO + 1 NC  3SE5 2...-HE10  <p>Ident. No. 11</p>
Twist levers¹⁾, type A 3SE5 2...-K2.  <p>v_{max} = 1.5 m/s Minimum torque in direction of operation: 0.25 Nm</p>	Deflection in direction of rotation 1 NO + 1 NC  3SE5 2...-BK21  <p>Ident. No. 11</p>	Deflection in direction of rotation 1 NO + 1 NC  3SE5 2...-HK21  <p>Ident. No. 11</p>
Twist levers¹⁾, adjustable length 3SE5 2...-K6.  <p>v_{max} = 1.5 m/s Minimum torque in direction of operation: 0.25 Nm</p>	Deflection in direction of rotation 1 NO + 1 NC  3SE5 2...-BC05 + head²⁾  <p>Ident. No. 11</p>	Deflection in direction of rotation 1 NO + 1 NC  3SE5 2...-HK60  <p>Ident. No. 11</p>
1 NO + 2 NC  3SE5 2...-KE10  <p>Ident. No. 12</p>	Short stroke 1 NO + 2 NC  3SE5 2...-FC05 + head²⁾  <p>Ident. No. 11</p>	
1 NO + 2 NC  3SE5 2...-LC05 + head²⁾  <p>Ident. No. 12</p>	Short stroke 1 NO + 2 NC  3SE5 2...-LE10  <p>Ident. No. 12</p>	

¹⁾ Adjustment of the lever in increments of 10°, maximum deflection 90°.

²⁾ The basic switch and actuator head must be ordered separately.

Limit Switches

SIRIUS 3SE5 International Limit Switches

3SE5, plastic enclosures
Enclosure widths 31 mm and 50 mm

Operation by bar (standard)

- ⊙ Operating point acc. to EN 50041/47 (snap-action)
- * Operating point on return (snap-action)
- ⊕ Positive opening acc. to EN 60947-5-1
- Direction of operation
- v_{max} Max. actuating speed

Slow-action contacts

- Contact closed
- Contact open

Snap-action contacts

- Contact closed
- Contact open

Twist levers¹⁾, adjustable length

3SE5 2...-K5.

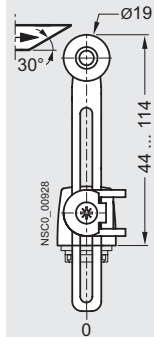

$v_{max} = 1.5$ m/s
Minimum torque
in direction of operation: 0.25 Nm

1 NO + 1 NC

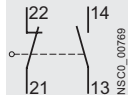

Ident. No. 11

Deflection in direction of rotation

3SE5 2...-BK50

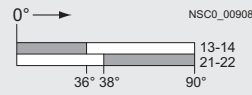

1 NO + 1 NC

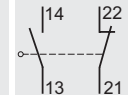

Ident. No. 11

Deflection in direction of rotation

3SE5 2...-HK50

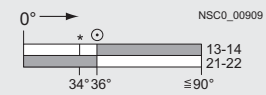

Rod actuators¹⁾, type D

3SE5 2...-K8.

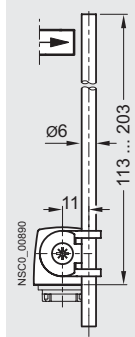

$v_{max} = 1.5$ m/s
Minimum torque
in direction of operation: 0.25 Nm

1 NO + 1 NC

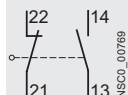

Ident. No. 11

Deflection in direction of rotation

3SE5 2...-BC05 + head²⁾

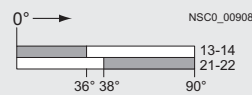

1 NO + 1 NC

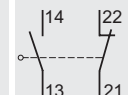

Ident. No. 11

Deflection in direction of rotation

3SE5 2...-HK80, -HK82

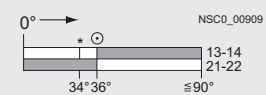

Spring rods

3SE5 2...-R0.

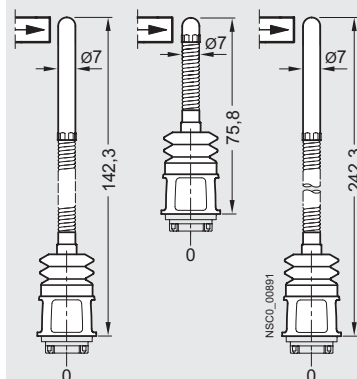

$v_{max} = 1$ m/s
Minimum force required
in direction of operation: 9 N

The spring rods can be used only with snap-action contacts.

1 NO + 1 NC

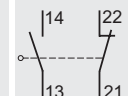

Ident. No. 11

Deflection of spring rod

3SE5 2...-HR01

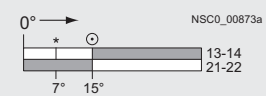

1 NO + 1 NC

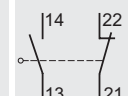

Ident. No. 11

3SE5 2...-FC05 + head²⁾

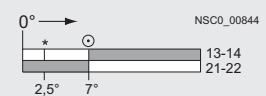

1 NO + 2 NC

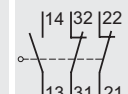

Ident. No. 12

3SE5 2...-LC05 + head²⁾

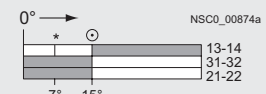

¹⁾ Adjustment of the lever in increments of 10°, maximum deflection 90°.

²⁾ The basic switch and actuator head must be ordered separately.

Limit Switches

SIRIUS 3SE5 International Limit Switches

3SE5, metal enclosures
Enclosure widths 40 mm and 56 mm

1
2
3
4
5
6
7
8
9
10
11
12
13

Configuration

Actuation and operating travel (angle) for enclosure width 40 mm and 56 mm

Operation by bar (standard)	Slow-action contacts		Snap-action contacts	
<ul style="list-style-type: none"> ⊙ Operating point acc. to EN 50041 (snap-action) * Operating point on return (snap-action) ⊕ Positive opening acc. to EN 60947-5-1 → Direction of operation v_{max} Max. actuating speed Contact closed Contact open 	1 NO + 1 NC Ident. No. 11	1 NO + 2 NC Ident. No. 12	1 NO + 1 NC Ident. No. 11	1 NO + 2 NC Ident. No. 12

Rounded plungers, type B

	Actuation along plunger axis		Actuation along plunger axis	
3SE5 1...-C02 $v_{max} = 1.5 \text{ m/s}$ Minimum force required in direction of operation: 18 N	3SE5 1...-BC02 Ident. No. 11	3SE5 1...-KC02 Ident. No. 12	3SE5 1...-CC02 Ident. No. 11	3SE5 1...-LC02 Ident. No. 12

Angular roller levers

	Actuation along plunger axis		Actuation along plunger axis	
3SE5 112...F0. $v_{max} = 2.5 \text{ m/s}$ Minimum force required in direction of operation: 9 N	3SE5 1...-BF01 Ident. No. 11	3SE5 1...-KA00 + head¹⁾ Ident. No. 12	3SE5 1...-CF01 Ident. No. 11	3SE5 1...-LF01 Ident. No. 12

Operation by bar (standard)	Slow-action contacts	Snap-action contacts	
<ul style="list-style-type: none"> ⊙ Operating point acc. to EN 50041 (snap-action) * Operating point on return (snap-action) ⊕ Positive opening acc. to EN 60947-5-1 → Direction of operation v_{max} Max. actuating speed 	<ul style="list-style-type: none"> Contact closed Contact open 	<ul style="list-style-type: none"> Contact closed Contact open 	

Roller plungers, type C

	Lateral actuation		Lateral actuation	
3SE5 1...-D02 $v_{max} = 1 \text{ m/s}$ Minimum force required in direction of operation: 18 N	1 NO + 1 NC Ident. No. 11	3SE5 1...-BD02 Ident. No. 11	1 NO + 1 NC Ident. No. 11	3SE5 1...-CD02 Ident. No. 12
	1 NO + 2 NC Ident. No. 12	3SE5 1...-KD02 Ident. No. 11	1 NO + 2 NC Ident. No. 12	3SE5 1...-LD02 Ident. No. 12

¹⁾ The basic switch and actuator head must be ordered separately.





Limit Switches

SIRIUS 3SE5 International Limit Switches

3SE5, plastic enclosures
Enclosure widths 31 mm and 50 mm

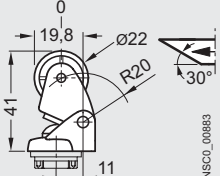
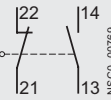
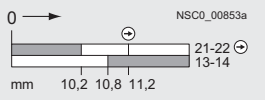
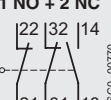
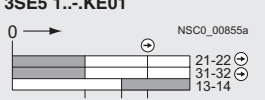
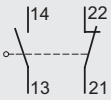
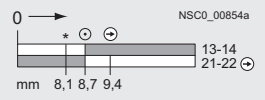
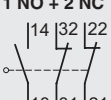
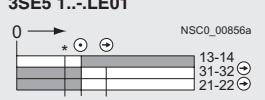
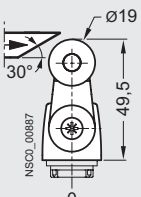
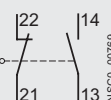
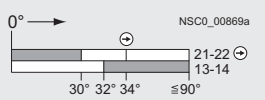
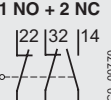
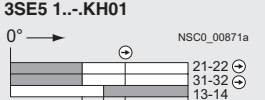
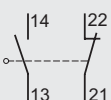
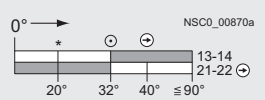
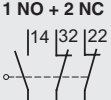
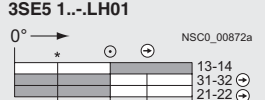
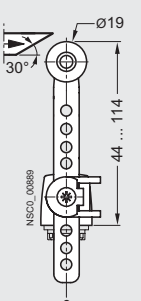
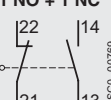
Configuration

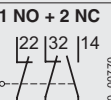
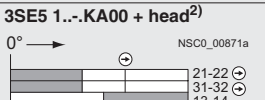
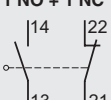
Actuation and operating travel (angle) for enclosure width 40 mm and 56 mm

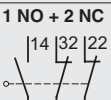
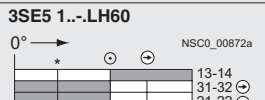
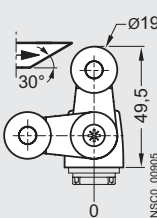
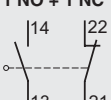
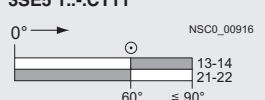
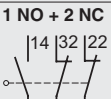
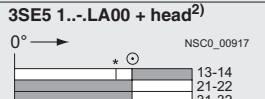
Operation by bar (standard) ○ Operating point acc. to EN 50041 (snap-action) * Operating point on return (snap-action) → Positive opening acc. to EN 60947-5-1 → Direction of operation V _{max} Max. actuating speed	Slow-action contacts ■ Contact closed □ Contact open	Snap-action contacts ■ Contact closed □ Contact open
Roller levers 3SE5 1...-E0.  <p>V_{max} = 2.5 m/s Minimum force required in direction of operation: 9 N</p>	Lateral actuation 1 NO + 1 NC  <p>Ident. No. 11</p> 3SE5 1...-BE01  <p>Ident. No. 11</p> 1 NO + 2 NC  <p>Ident. No. 12</p> 3SE5 1...-KE01  <p>Ident. No. 12</p>	Lateral actuation 1 NO + 1 NC  <p>Ident. No. 11</p> 3SE5 1...-CE01  <p>Ident. No. 11</p> 1 NO + 2 NC  <p>Ident. No. 12</p> 3SE5 1...-LE01  <p>Ident. No. 12</p>
Twist levers¹⁾, type A 3SE5 1...-H0.  <p>V_{max} = 1.5 m/s Minimum torque in direction of operation: 0.25 Nm</p>	Deflection in direction of rotation 1 NO + 1 NC  <p>Ident. No. 11</p> 3SE5 1...-BH01  <p>Ident. No. 11</p> 1 NO + 2 NC  <p>Ident. No. 12</p> 3SE5 1...-KH01  <p>Ident. No. 12</p>	Deflection in direction of rotation 1 NO + 1 NC  <p>Ident. No. 11</p> 3SE5 1...-CH01  <p>Ident. No. 11</p> 1 NO + 2 NC  <p>Ident. No. 12</p> 3SE5 1...-LH01  <p>Ident. No. 12</p>
Twist levers¹⁾, adjustable length 3SE5 1...-H6.  <p>V_{max} = 1.5 m/s Minimum torque in direction of operation: 0.25 Nm</p>	Deflection in direction of rotation 1 NO + 1 NC  <p>Ident. No. 11</p> 3SE5 1...-BH60  <p>Ident. No. 11</p> 1 NO + 2 NC  <p>Ident. No. 12</p> 3SE5 1...-KA00 + head²⁾  <p>Ident. No. 12</p>	Deflection in direction of rotation 1 NO + 1 NC  <p>Ident. No. 11</p> 3SE5 1...-CH60  <p>Ident. No. 11</p> 1 NO + 2 NC  <p>Ident. No. 12</p> 3SE5 1...-LH60  <p>Ident. No. 12</p>
Fork levers¹⁾ 3SE5 1...-T1.  <p>V_{max} = 1.5 m/s Minimum torque in direction of operation: 0.25 Nm</p>	The fork levers can be used only with snap-action contacts.	Deflection in direction of rotation 1 NO + 1 NC  <p>Ident. No. 11</p> 3SE5 1...-CT11  <p>Ident. No. 11</p> 1 NO + 2 NC  <p>Ident. No. 12</p> 3SE5 1...-LA00 + head²⁾  <p>Ident. No. 12</p>

¹⁾ Adjustment of the lever in increments of 10°, maximum deflection 90°.

²⁾ The basic switch and actuator head must be ordered separately.

Limit Switches

SIRIUS 3SE5 International Limit Switches

3SE5, metal enclosures
Enclosure widths 40 mm and 56 mm

Operation by bar (standard)

- Operating point acc. to EN 50041/47 (snap-action)
- * Operating point on return (snap-action)
- ⊕ Positive opening acc. to EN 60947-5-1
- Direction of operation
- v_{ma} Max. actuating speed

Slow-action contacts

- Contact closed
- Contact open

Snap-action contacts

- Contact closed
- Contact open

Twist levers¹⁾, adjustable length

3SE5 1...-H5.

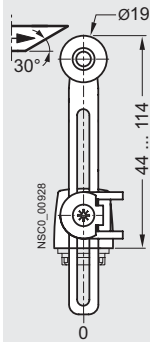

$v_{max} = 1.5 \text{ m/s}$
Minimum torque
in direction of operation: 0.25 Nm

1 NO + 1 NC

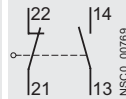

Ident. No. 11

Deflection in direction of rotation

3SE5 1...-BH50

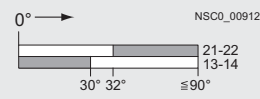

1 NO + 1 NC

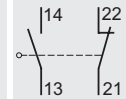

Ident. No. 11

Deflection in direction of rotation

3SE5 1...-CH50, -CH51

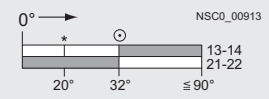

1 NO + 2 NC

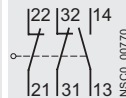

Ident. No. 12

3SE5 1...-KA00 + head²⁾

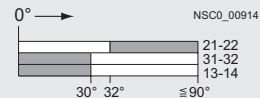

1 NO + 2 NC

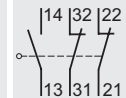

Ident. No. 12

3SE5 1...-LH50

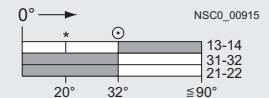

Rod actuators¹⁾, type D

3SE5 1...-H8.

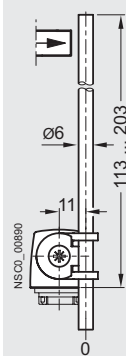

$v_{max} = 1.5 \text{ m/s}$
Minimum torque
in direction of operation: 0.25 Nm

1 NO + 1 NC

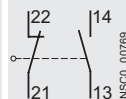

Ident. No. 11

Deflection in direction of rotation

3SE5 1...-BA00 + head²⁾

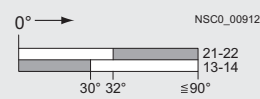

1 NO + 1 NC

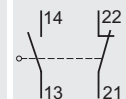

Ident. No. 11

Deflection in direction of rotation

3SE5 1...-CH80, -CH82

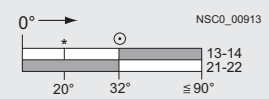

1 NO + 2 NC

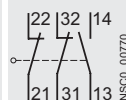

Ident. No. 12

3SE5 1...-KA00 + head²⁾

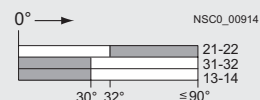

1 NO + 2 NC

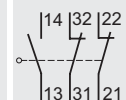

Ident. No. 12

3SE5 1...-LA00 + head²⁾

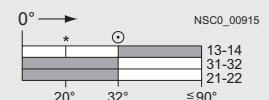

Spring rods

3SE5 1...-R0.

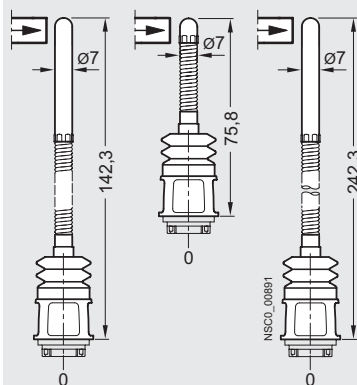

$v_{max} = 1 \text{ m/s}$
Minimum force required
in direction of operation: 9 N

The spring rods can be used only with snap-action contacts.

1 NO + 1 NC

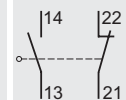

Ident. No. 11

Deflection of spring rod

3SE5 1...-CR01

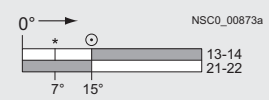

1 NO + 2 NC

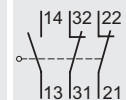

Ident. No. 12

3SE5 1...-LA00 + head²⁾

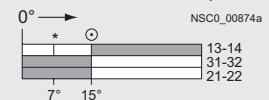

¹⁾ Adjustment of the lever in increments of 10°, maximum deflection 90°.

²⁾ The basic switch and actuator head must be ordered separately.

Limit Switches

SIRIUS 3SE5 International Limit Switches

Dimensional drawings

Dimensions of the basic switches

Enclosure width 31 mm, EN 50047, with M20 x 1.5 connecting thread 3SE5 232, 3SE5 212

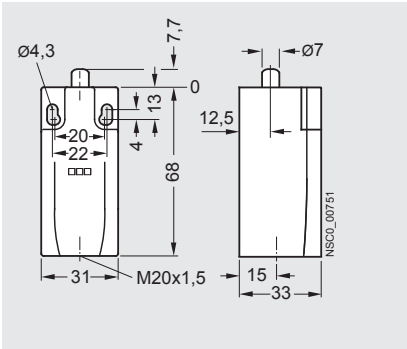

Enclosure width 31 mm, EN 50047, rear with fixing holes 3SE5 232, 3SE5 212

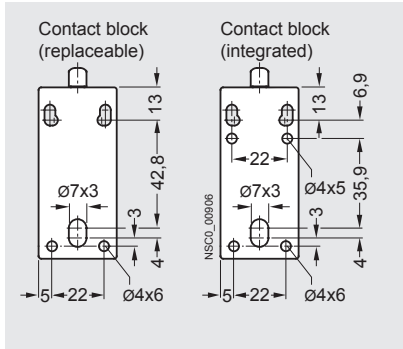

Enclosure width 31 mm, EN 50047, with M12 connector socket 3SE5 234, 3SE5 212

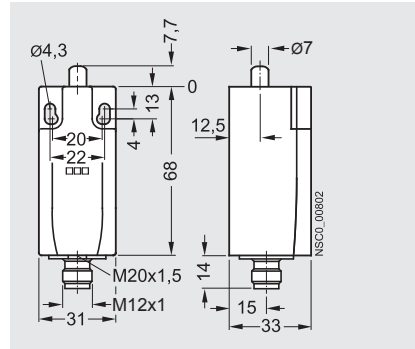

Enclosure width 50 mm, with M20 x 1.5 connecting thread 3SE5 242

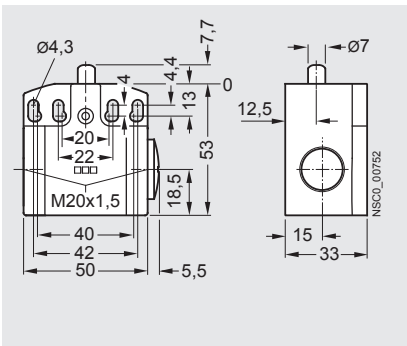

Enclosure width 50 mm, rear with fixing holes 3SE5 242

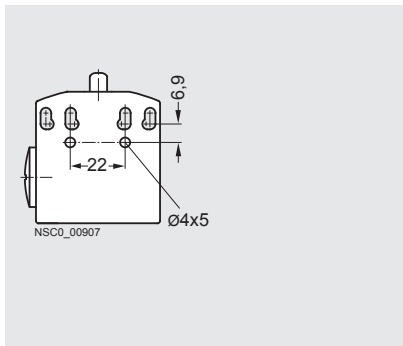

Enclosure width 40 mm, EN 50041, with M20 x 1.5 connecting thread 3SE5 112, 3SE5 132

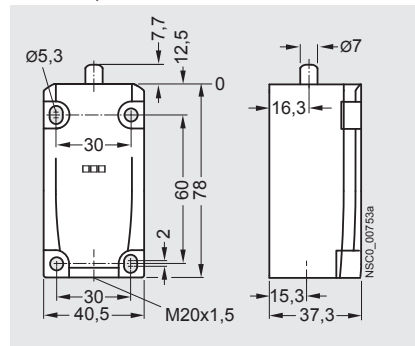

Enclosure width 40 mm, EN 50041, with 6-pole connector socket 3SE5 115

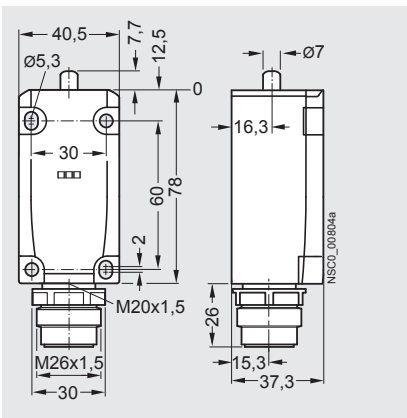

Enclosure width 56 mm, with M20 x 1.5 connecting thread 3SE5 122

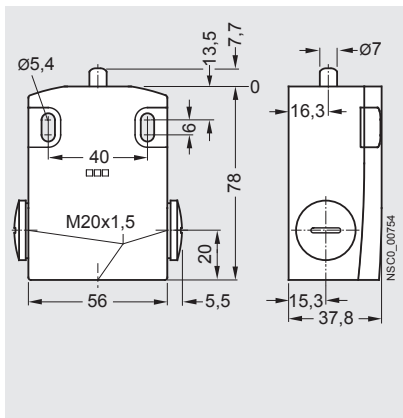

XL enclosure, width 56 mm, with M20 x 1.5 connecting thread 3SE5 162

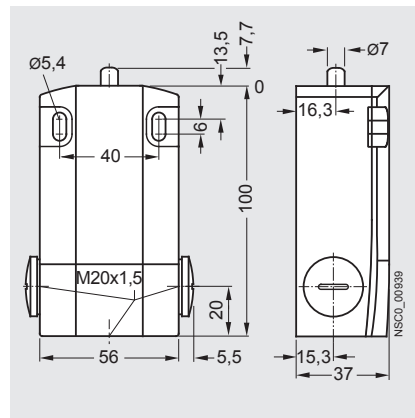

Operating mechanisms for basic switches, see pages 13/59 and 13/60.

Limit Switches

SIRIUS 3SE5 International Limit Switches

3SE5, open-type design

Operating mechanisms for enclosure width 31 mm and 50 mm

Roller plunger, type C acc. to EN 50047

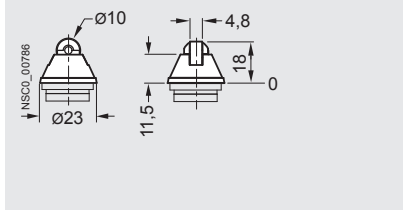

Roller plunger with central fixing

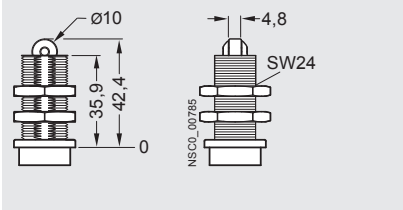

Roller lever, type E acc. to EN 50047

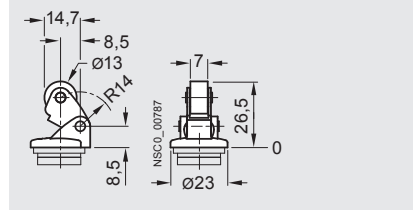

Angular roller lever

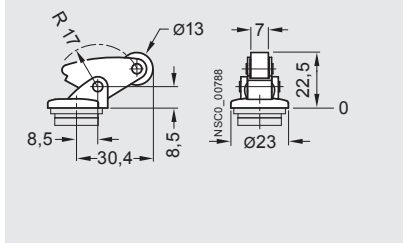

Twist lever, type A acc. to EN 50047

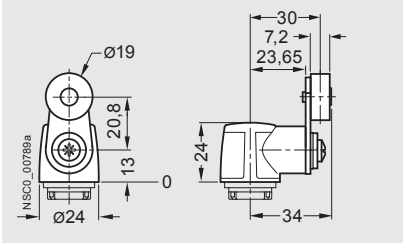

Twist lever, roller 30 mm

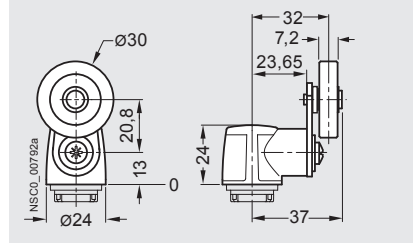

Operating mechanism for enclosure width 40 mm and 56 mm

Plain plunger



Rounded plunger, type B acc. to EN 50041

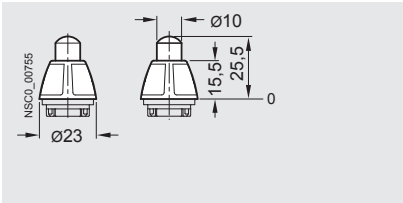

Roller plunger, type C acc. to EN 50041

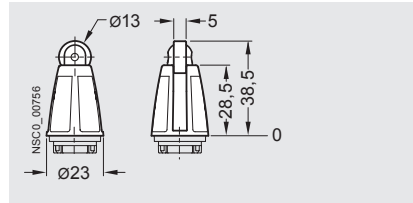

Roller lever

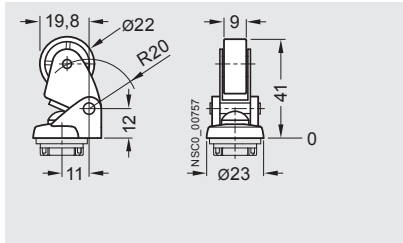

Angular roller lever

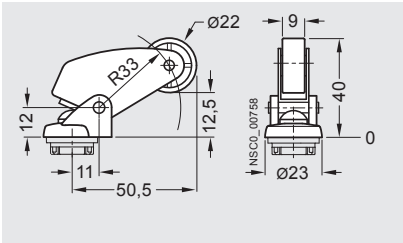

Twist lever, type A acc. to EN 50041

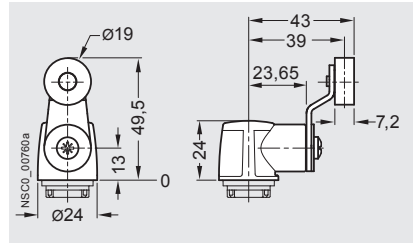

Twist lever, 2 rollers 19 mm

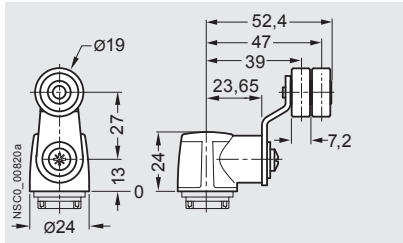

Fork lever, roller 19 mm

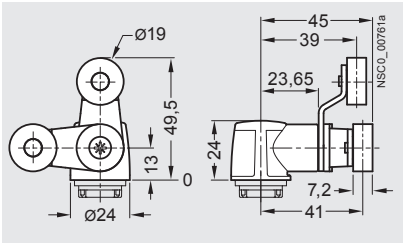

Twist lever, roller 30 mm

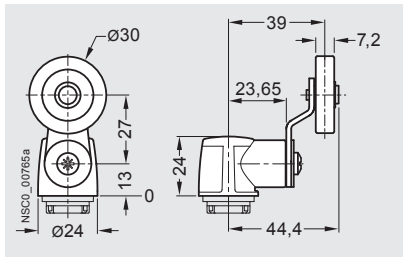

Twist lever, roller 50 mm

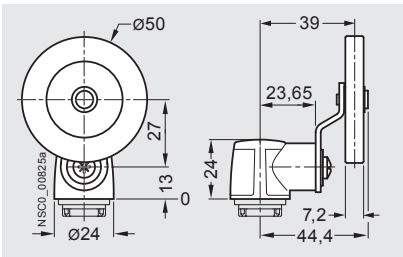

Twist lever, rubber roller 50 mm

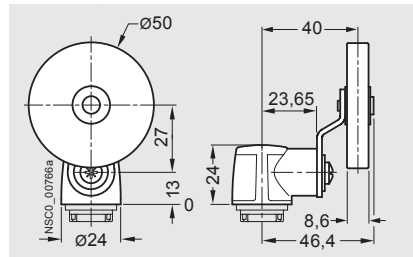

Limit Switches

SIRIUS 3SE5 International Limit Switches

Dimensional drawings

Operating mechanisms for all enclosure widths

Twist lever, adjustable length, roller 19 mm

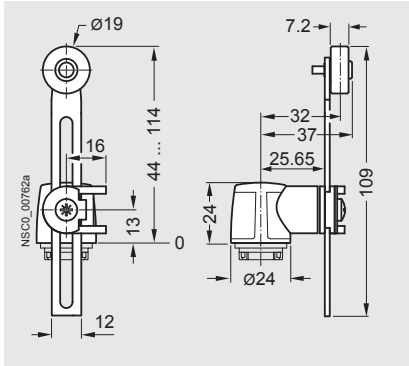

Twist lever, adjustable length, with grid hole, roller 19 mm

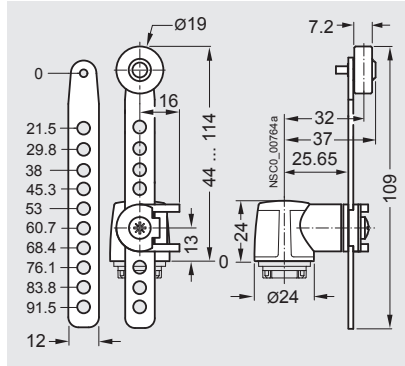

Twist lever, adjustable length, roller 30 mm

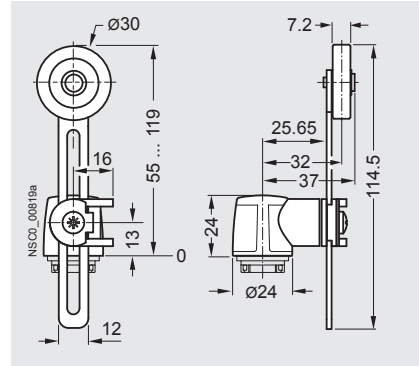

Twist lever, adjustable length, roller 50 mm

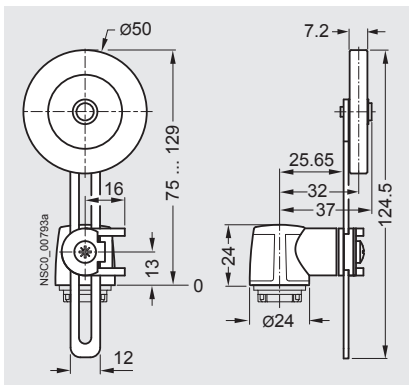

Twist lever, adjustable length, rubber roller 50 mm

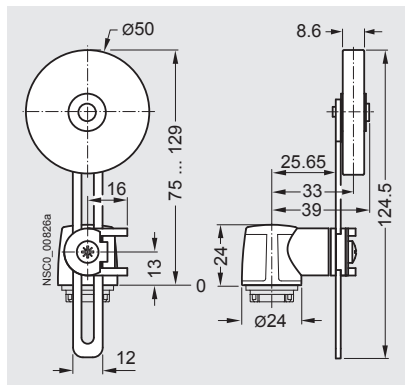

Twist lever, adjustable length, with grid hole, rubber roller 50 mm

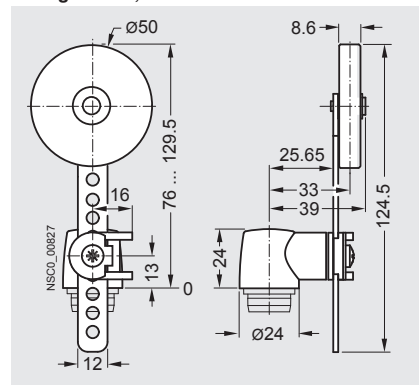

Rod actuator

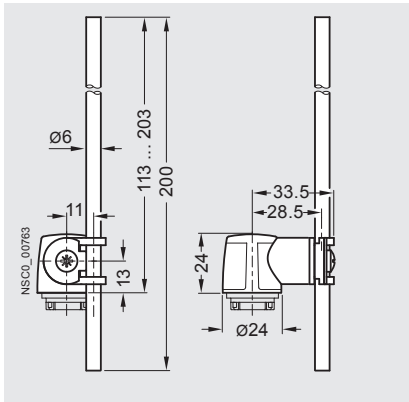

Spring rod, length 142.5 mm

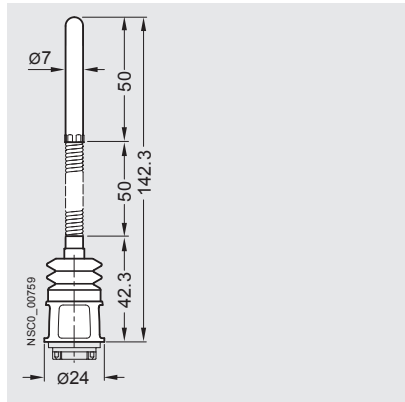

Spring rod, length 242.5 mm

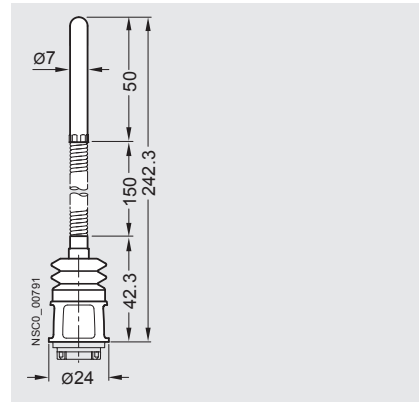

Spring rod, length 76 mm

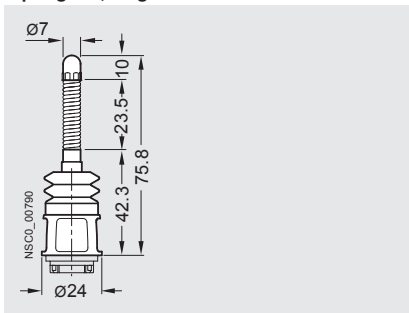

Limit Switches

SIRIUS 3SE5 International Limit Switches

Dimensional drawings

Circuit diagrams

Enclosure widths 31, 40, 50 and 56 mm

Slow-action contacts
1 NO + 1 NC
3SE5 ...-B..., -R...

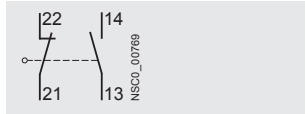

Slow-action contacts
2 NO + 1 NC
3SE5 ...-P...

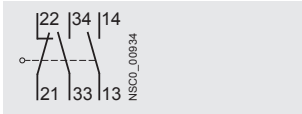

Snap-action contacts
1 NO + 1 NC
3SE5 ...-C..., -F..., -G..., -H..., -N...

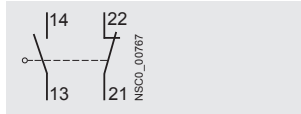

Slow-action contacts
1 NO + 2 NC
3SE5 ...-K..., -Q...

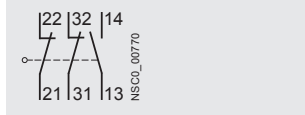

Slow-action contacts
1 NO + 2 NC with make-before-break, 3SE5 ...-M...

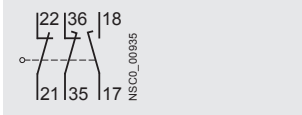

Snap-action contacts
1 NO + 2 NC
3SE5 ...-L...

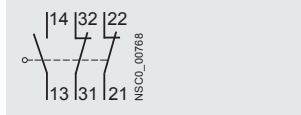

XL enclosures, width 56 mm

Slow-action contacts
2 x (1 NO + 1 NC)
3SE5 162-0B...

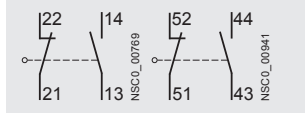

Slow-action contacts
2 x (1 NO + 2 NC) with make-before-break, 3SE5 162-0D...

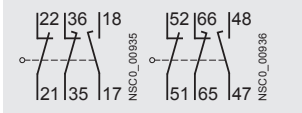

For slow-action contacts
1 NO + 2 NC with make-before-break, 1 NO + 1 NC, 3SE5 162-0E...

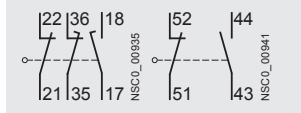

Snap-action contacts
2 x (1 NO + 1 NC)
3SE5 162-0C...

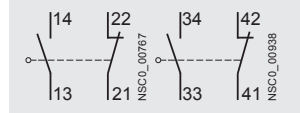

3SE5 connector assignment

M12 connector socket, 4-pole
3SY3 127

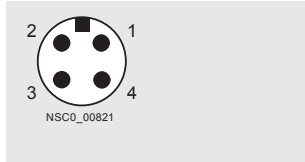

M12 connector socket, 5-pole
3SY3 128

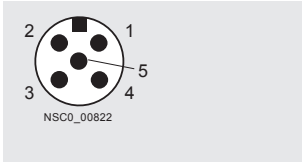

M12 connector socket, 8-pole
3SY3 134

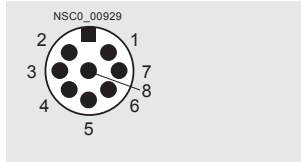

Connector sockets, 6-pole + PE
3SY3 131

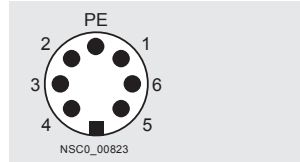

Order No.	Connector sockets Type	Contacts Version	LEDs Version	Connections									
				Pin 1	Pin 2	Pin 3	Pin 4	Pin 5	Pin 6	Pin 7	Pin 8	PE	
M12 connector sockets (4-, 5- or 8-pole)													
3SE5..4-0.....1AC4	3SY3 127	1 NO + 1 NC	—	21	22	13	14	—	—	—	—	—	—
3SE5..4-0.....1AC5	3SY3 128	1 NO + 1 NC	—	21	22	13	14	PE	—	—	—	—	—
3SE5..4-0.....1AE0	3SY3 127	2 NC	—	21	22	31	32	—	—	—	—	—	—
3SE5..4-0.....1AE1	3SY3 128	2 NC	—	21	22	31	32	PE	—	—	—	—	—
3SE5..4-1C....1AF3	3SY3 128	1 NO + 1 NC snap action	2 LEDs	21	22	13/ LED gn	14/ LED ye	Ground LED	—	—	—	—	—
3SE5..4-1B....1AF3	3SY3 128	1 NO + 1 NC slow-action	2 LEDs	21	22	14/ LED gn	13/ LED ye	Ground LED	—	—	—	—	—
3SE5..4-1L....1AD4	3SY3 134	1 NO + 2 NC snap action	2 LEDs	21	22	13/ LED gn	14/ LED ye	31	32	Ground LED	PE	—	—
3SE5..4-1K....1AD4	3SY3 134	1 NO + 2 NC slow-action	2 LEDs	21	22	14/ LED gn	13/ LED ye	31	32	Ground LED	PE	—	—
Connector sockets, 6-pole + PE													
3SE5..5-0.....1AD0	3SY3 131	1 NO + 1 NC	—	21	22	13	14	—	—	—	—	—	✓
3SE5..5-0.....1AD1	3SY3 131	1 NO + 2 NC	—	21	22	13	14	31	32	—	—	—	✓
3SE5..5-C....1AF2	3SY3 131	1 NO + 1 NC snap action	2 LEDs	21	22	13/ LED gn	14/ LED ye	—	Ground LED	—	—	—	✓
3SE5..5-B....1AF2	3SY3 131	1 NO + 1 NC slow-action	2 LEDs	21	22	14/ LED gn	13/ LED ye	—	Ground LED	—	—	—	✓
3SE5..5-L....1AD2	3SY3 131	2 NC snap-action	2 LEDs	21	22	31	32	13/ LED gn	Ground LED	—	—	—	✓
3SE5..5-K....1AD2	3SY3 131	2 NC slow-action	2 LEDs	21	22	31	32	14/ LED gn	Ground LED	—	—	—	✓

gn Green
ye Yellow

✓ Connected
— Not available

Limit Switches

3SE03 North American Limit Switches

General Information

Features

Modular plug-in



Prewired receptacle with pin connector



Prewired cable



Features

- UL Listed, CSA Certified.
- UL File: E47512
- All Metal Captive Screws.
- Keyed, Four-Directional Head.
- Steel-Reinforced Diaphragm Seal Between Operational Head And Switch Body.
- Permanent Instructions for Adjusting Operational Head.
- Modular, Plug-In Housing
 1. Heavy-Duty, Bifurcated, Plug-In Prongs.
 2. Ample Receptacle Wiring Space with 1/2 - NPT threaded conduit opening.
 3. Stepped Terminals On Single Pole; Deep Center Trough On Double Pole.
- NEMA Type 6P Submersible
 1. Completely Sealed With Epoxy.
 2. SOOW-A Cable or Prewired Receptacle With Pin Connector.
 3. Factory wired cable features a 350 pound pullput capacity.
- Rotary heads are field convertible CW, CCW, or both without special tools.

Design

Modular Plug-In Housing

These heavy duty plug-in limit switches may be provided as complete devices using a composite catalog number; or, separately as components; operating head, plug-in module and base receptacle.

Example:

Complete Switch:

3SE03-AR1

Single Pole, Double Throw contacts with Side Rotary, Momentary Head

Components

3SE03-SA[Ⓞ]

Single Pole, Double Throw Plug-in Module

3SE03-DR1

Side Rotary Head, Momentary

3SE03-RA[Ⓞ]

Standard, Single Pole Receptacle, 1 NO + 1 NC

Since components may be interchanged, operating heads, plug-in modules and receptacles may be combined to satisfy most of your everyday limit switch requirements. This leads to less inventory with greater flexibility.

Operating heads include side rotary; plain and roller plunger; and, wobble. A variety of levers are available.

The zinc die-cast housing has an epoxy finish to protect against corrosion. All screws on the module and head are captive.

NEMA Type 6P Submersible

These heavy duty prewired, factory sealed switches meet the demanding enclosure requirements of UL (NEMA) Type 3, 4, 4X, 6P, 12, and 13. They are intended for wet environments where the integrity of the threaded conduit and switch body seals must be assured.

The switch body cavity including threaded conduit entry is completely sealed with epoxy. An 8 foot, 5 or 9 conductor SOOW-A cable; or 5 or 9 pin prewired receptacle with pin connector is provided as standard.

Switches are provided as complete devices using composite catalog numbers; or, separately as components; operating head and switch body.

UL (NEMA) Type 6P switches are designed to provide a degree of protection against the entry of water during prolonged submersion at limited depths (tested with a 6 foot head of water for 24 hours).

Both the Modular Plug-in and the (NEMA) Type 6P Submersible styles provide 60 Amp make and 6 Amp break—120V AC and 10 Amp continuous current for 120, 240, 480 and 600V AC. The circuit contact configuration depends on the device selected and the application criteria.

Switches are available with momentary or maintained operating heads; and, single pole, double pole or center neutral (modular, plug-in only) contact configurations.

3SE03 limit switches offer a new standard of reliability and quality in automatic control circuits under heavy duty applications.

[Ⓞ] Plug-in module and receptacle are keyed.

Limit Switches

3SE03 North American Limit Switches

Modular, plug-in and
NEMA type 6P submersible

1
2
3
4
5
6
7
8
9
10
11
12
13

Technical data

Type	Modular, Plug-in and NEMA Type 6P Submersible					
Mechanical life	Side rotary: 13×10^6 make-break operations minimum All others: 10×10^6 make-break operations minimum					
Electrical life	Single Pole: 1×10^6 operations typical at full load Double Pole: 1×10^5 operations typical at full load					
Switching frequency	8×10^3 make-break operations per hour (maximum)					
Operating point accuracy	Side operated: 0.0012 in. (modular, plug-in housing) Side rotary: 0.0014 in. (modular plug-in). Top operated: 0.0003 in. (modular, plug-in housing)					
Cable entry	1/2 in.-NPT, Prewired Cable or Prewired Receptacle with Pin Connector					
Ambient temperature	Without Cable: -10° to $+121^\circ\text{C}$, 14° to 250°F With Cable: -10° to $+105^\circ\text{C}$, 14° to 221°F					
Degree of protection	NEMA Type 1, 3, 3S, 4, 4X, 6, 6P, 13; IP67					
Conductor size	22–12 AWG (modular, plug-in housing), single or stranded wire 5 or 9 conductor, 16 AWG yellow jacketed type SOOW-A cable (prewired cable) 5 or 9 pin, 0.87 in. (22 mm) diameter receptacle (prewired receptacle with pin connector)					
Mounting	Any position					
Tightening Torque	Switch body screws: 25–30 lb-in. Operating head screws: 14–18 lb-in.					
NEMA rating	DC, NEMA R300			AC, NEMA A600		
Maximum current at	125V	250V	120V	240V	480V	600V
Make	0.22A	0.11A	60A	30A	15A	12A
Break	0.22A	0.11A	6A	3A	1.5A	1.2A
Max. volt-ampere						
Make	28VA	28VA	7200VA	7200VA	7200VA	7200VA
Break	28VA	28VA	720VA	720VA	720VA	720VA
Rated thermal current	DC, 1A			AC, 10A		
Rated operating voltage	DC, 300V			AC, 600V		

Operating temperature ^{1) 2)}

Temperature rating	Operation		Temperature range	
	Type	Return	Without cable	With cable
1	Side rotary ³⁾	Momentary CW only or CCW only	10°F to 200°F -12°C to 94°C	10°F to 200°F -12°C to 94°C
2	Center neutral Side rotary Side plunger Two-sided plunger Roller side plunger ⁴⁾	Momentary CW or CCW Maintained Momentary Maintained Momentary	14°F to 200°F -10°C to 94°C	14°F to 200°F -10°C to 94°C
3	Top plunger Top roller plunger ⁴⁾ Wobble head	Momentary Momentary Momentary	14°F to 250°F -10°C to 121°C	14°F to 221°F -10°C to 105°C

1) Temperature ranges below $+32^\circ\text{F}$ (0°C) are based on absence of freezing moisture or water.

2) For temperature rating of specific switch, refer to page 13/70, Operating Heads.

3) For CW only or CCW only operation, upper temperature limit increases to 250°F (121°C) without cable, and 221°F (105°C) with pre-wired cable.











4) Roller direction can be converted in the field.

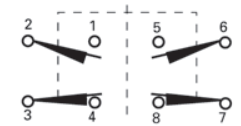



Limit Switches

3SE03 North American Limit Switches

Modular, plug-in metal housing

Complete switches without lever - threaded cable entry:

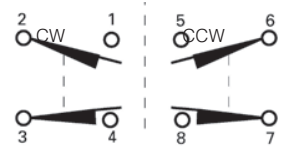
	Plug-In module type	Standard single pole 1 NO + 1 NC (3SE03-SA)	Standard double pole 2 NO + 2 NC (3SE03-SB)					
	Receptacle type surface mount	Single pole (3SE03-RA) 	Double pole (3SE03-RB) 					
Operating head type		Composite catalog number consisting of head, module and receptacle						
		DT	Catalog Number	List Price \$ 1 unit	DT	Catalog Number	List Price \$ 1 unit	
	Side rotary CW and CCW operation convertible to CW only or CCW only	Standard momentary (3SE03-DR1)	▶	3SE03-AR1 ^①		▶	3SE03-BR1 ^①	
		Standard maintained (3SE03-DM1)	▶	3SE03-AM1		▶	3SE03-BM1	
		Low torqued momentary (3SE03-DL1)	▶	3SE03-AL1 ^②			3SE03-BL1 ^②	
	Plain side plunger	Momentary (3SE03-DS1)	▶	3SE03-AS1		▶	3SE03-BS1	
	Roller side plunger	Momentary (3SE03-DS3)	▶	3SE03-AS3			3SE03-BS3	
	Two-sided plunger	Maintained (3SE03-DH1)		3SE03-AH1			3SE03-BH1	
	Plain top plunger	Momentary (3SE03-DT1)	▶	3SE03-AT1			3SE03-BT1	
	Roller top plunger	Momentary (3SE03-DT3)		3SE03-AT3		▶	3SE03-BT3	
	Wobble head (without lever)	Momentary (3SE03-DW1)	▶	3SE03-AW1		▶	3SE03-BW1	

	Plug-In module type	Center neutral Double pole 2 NO + 2 NC (3SE03-SN)				
	Receptacle type surface mount	Center neutral (3SE03-RB) 				
Operating head type		Composite catalog number consisting of head, module and receptacle				
		DT	Catalog Number	List Price \$ 1 unit		
	Side rotary (momentary)	Center	(3SE03-DN1)	▶	3SE03-NN1 ^①	
		Neutral	(3SE03-DN2)	▶	3SE03-NN2 ^②	

① 5° pretravel to operate contacts.

② 15° pretravel to operate contacts.



Limit Switches





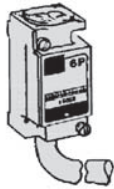

3SE03 North American Limit Switches

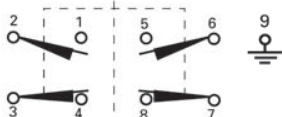
NEMA type 6P submersible, prewired cable

1
2
3
4
5
6
7
8
9
10
11
12
13

Complete switches without lever - prewired cable:

 <p>Switch body type—prewired cable with 8 foot cable</p>	<p>Single pole 1 NO + 1 NC (3SE03-SA6P)</p> <p>Cable color code 1 - White 2 - Black 3 - Red 4 - Orange 5 - Green</p>	<p>Double pole 2 NO + 2 NC (3SE03-SB6P)</p> <p>Cable color code 1 - White 6 - Pink 2 - Black 7 - Yellow 3 - Red 8 - Blue 4 - Orange 9 - Green 5 - Brown</p>
		

Operating head type		Composite catalog number consisting of head and switch body				
		DT	Catalog Number	List Price \$ 1 unit	Catalog Number	List Price \$ 1 unit
 <p>Side rotary CW and CCW operation convertible to CW only or CCW only</p>	Standard momentary (3SE03-DR1)	▶	3SE03-AR16P		3SE03-BR16P	
	Standard maintained (3SE03-DM1)		3SE03-AM16P		3SE03-BM16P	
	Low torqued momentary (3SE03-DL1)		3SE03-AL16P		3SE03-BL16P	
 <p>Plain side plunger</p>	Momentary (3SE03-DS1)		3SE03-AS16P		3SE03-BS16P	
 <p>Roller side plunger</p>	Momentary (3SE03-DS3)		3SE03-AS36P		3SE03-BS36P	
 <p>Two-sided plunger</p>	Maintained (3SE03-DH1)		3SE03-AH16P		Not available	
 <p>Plain top plunger</p>	Momentary (3SE03-DT1)		3SE03-AT16P		3SE03-BT16P	
 <p>Roller top plunger</p>	Momentary (3SE03-DT3)		3SE03-AT36P		3SE03-BT36P	
 <p>Wobble head (without lever)</p>	Momentary (3SE03-DW1)		3SE03-AW16P		3SE03-BW16P	





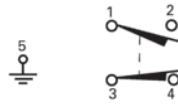
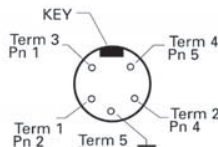
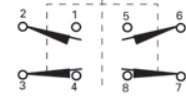
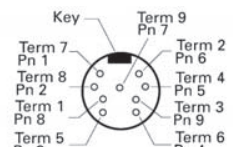

Limit Switches

3SE03 North American Limit Switches

**NEMA type 6P submersible,
prewired receptacle**

Complete switches without lever - prewired receptacle with pin connector:

 <p>Switch Body Type—prewired receptacle with pin connector</p>	<p>Single pole 1 NO + 1 NC (3SE03-SA6PC)</p>  	<p>Double pole 2 NO + 2 NC (3SE03-SB6PC)</p>  
--	--	--

Operating head type		Composite catalog number consisting of head and switch body				
		DT	Catalog Number	List Price \$ 1 unit	Catalog Number	List Price \$ 1 unit
 <p>Side rotary CW and CCW operation convertible to CW only or CCW only</p>	Standard momentary (3SE03-DR1)	▶	3SE03-AR16PC		3SE03-BR16PC	
	Standard maintained (3SE03-DM1)		3SE03-AM16PC		3SE03-BM16PC	
	Low torqued momentary (3SE03-DL1)		3SE03-AL16PC		3SE03-BL16PC	
 <p>Plain side plunger</p>	Momentary (3SE03-DS1)		3SE03-AS16PC		3SE03-BS16PC	
 <p>Roller side plunger</p>	Momentary (3SE03-DS3)		3SE03-AS36PC		3SE03-BS36PC	
 <p>Two-sided plunger</p>	Maintained (3SE03-DH1)		3SE03-AH16PC		Not available	
 <p>Plain top plunger</p>	Momentary (3SE03-DT1)		3SE03-AT16PC		3SE03-BT16PC	
 <p>Roller top plunger</p>	Momentary (3SE03-DT3)		3SE03-AT36PC		3SE03-BT36PC	
 <p>Wobble head (without lever)</p>	Momentary (3SE03-DW1)		3SE03-AW16PC		3SE03-BW16PC	

Limit Switches

3SE03 North American Limit Switches



Modular, plug-in and
NEMA type 6P submersible

Components:









 Plug-in module	Plug-in module		DT	Catalog Number	List Price \$ 1 unit
		Standard single pole 1 NO + 1 NC	▶	3SE03-SA	
		Standard double pole 2 NO + 2 NC	▶	3SE03-SB	
		Center neutral 2 NO + 2 NC ^①	▶	3SE03-SN	

 Receptacle	Receptacle for plug-in module			Catalog Number	List Price \$ 1 unit
		Single pole 1 NO + 1 NC (5 terminals)	▶	3SE03-RA	
		Single pole 2 NO + 2 NC (9 terminals)		3SE03-RB	

Switch body—NEMA type 6P submersible:

 Prewired cable	Switch body	Prewired cable 8 foot length			Prewired receptacle with pin connector		
		DT	Catalog Number	List Price \$ 1 unit	DT	Catalog Number	List Price \$ 1 unit
 Prewired receptacle	Single pole 1 NO + 1 NC	▶	3SE03-SA6P		—	—	
	Single pole 2 NO + 2 NC	▶	3SE03-SB6P		—	—	
	Single pole 1 NO + 1 NC		—	—	▶	3SE03-SA6PC	
	Single pole 2 NO + 2 NC		—	—	▶	3SE03-SB6PC	

Operating heads^②:

 Operating head type		Nominal operating data								
		Total travel	Pretravel	Operating force	Release position	Minimum return force	Operating temp range ^④	DT	Catalog Number	List Price \$ 1 unit
 Side rotary ^③	Standard momentary ^⑤	90°	5°	3 lb-in.	2°	4.5 oz-in.	1	▶	3SE03-DR1	
	Low torqued momentary ^⑤	90°	15°	1.5 lb-in.	6°	2.5 oz-in.	1	▶	3SE03-DL1	
	Standard maintained	90°	50°	3 lb-in.	50°	—	2	▶	3SE03-DM1	
 Plain side plunger	Momentary	0.25 in.	0.065 in.	4 lbs	0.03 in.	8 oz.	2	▶	3SE03-DS1	
 Roller side plunger	Momentary ^⑦	0.25 in.	0.065 in.	4 lbs	0.03 in.	8 oz.	2	▶	3SE03-DS3	
 Two-sided plunger	Maintained	0.32 in.	0.2 in.	5 lbs	0.13 in.	5 lbs	2	▶	3SE03-DH1	
 Plain top plunger	Momentary	0.28 in.	0.04 in.	4 lbs	0.02 in.	8 oz.	3	▶	3SE03-DT1	
 Roller top plunger	Momentary	0.28 in.	0.04 in.	4 lbs	0.02 in.	8 oz.	3	▶	3SE03-DT3	
 Wobble head ^{⑧⑨}	Momentary	15°	10°	2 lb-in.	6°	2.4 oz-in.	3	▶	3SE03-DW1	
 Center neutral ^⑨	Momentary	90°	5°	1.8 lb-in.	2°	2.5 oz-in.	2	▶	3SE03-DN1	
		90°	15°	1.8 lb-in.	2°	2.5 oz-in.	2	▶	3SE03-DN2	

^① For use with 3SE03-DN1, -DN2 operating heads and 3SE03-RB receptacle only.

^② For use with modular, Plug-in and NEMA Type 6P.

^③

^④ Refer to "Operating Temperature", Catalog page 13/118 for Temperature Ranges.

^⑤ Without Operating Levers.

^⑥ CW and CCW operation. Convertible to CW or CCW operation only.

^⑦ Convertible—Horizontal to Vertical.

^⑧ Requires Lever.





^⑨ For use with 3SE03-SN plug-in module only.

Limit Switches

3SE03 North American Limit Switches

Modular, plug-in metal housing

Levers for plug-in and non-plug-in versions—most widely used

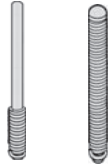
Description	Length ^①	Roller mounted on side of lever	Roller material	Roller diameter	Roller face width	Max required ^② return torque (oz-in.)	DT	Catalog Number	List Price \$ 1 unit
	1.5 (38)	Front	Nylatron	0.75 (19)	0.31 (8)	0.53	▶	3SX03-KL200	
	1.5 (38)	Front	Cast aluminum	0.75 (19)	0.31 (8)	1.10	▶	3SX03-KL355	
	1.5 (38)	Back	Cast aluminum	0.75 (19)	0.31 (8)	1.10	▶	3SX03-KL579	
	1.5 (38)	Back / back	Nylatron	0.75 (19)	0.31	-	▶	3SX03-KL204	
	1-3.5 (25-89)	Front	Nylatron	0.75 (19)	0.31 (8)	1.90 ^⑤	▶	3SX03-KL201	
	1-3.5 (25-89)	Front	Metal	0.75 (19)	0.31 (8)	3.40 ^⑤	▶	3SX03-KL538	
	9 (229)	-	Stainless steel	-	-	7.00 ^⑤	▶	3SX03-KL220	
	Adjustable spring rod	12.125 (308)	-	Nylon	-	-	3.50 ^⑤	▶	3SX03-KL556
	6 (152)	-	Nylatron	-	-	0.40	▶	3SX03-KL142	
Levers									
	Rod	-	-	Nylon	-	-	▶	3SX03-KW2	
	Coil spring	-	-	Coil spring	-	-	▶	3SX03-KW4	
	For plunger actuated switches wobble actuators	⑥							

Levers for plug-in and non-plug-in versions:

Operator	Length ^①	Roller			Max required ^② return torque (oz-in.)	Catalog Number			List Price \$ 1 unit
		Type	Diameter	Face (width)		Stainless steel	DT	Cast aluminum	
	0.87 (22)	Metal	0.75 (19)	0.31 (8)	0.62	-		3SX03-KL39	
	1.37 (35)	Metal	0.75 (19)	0.31 (8)	0.95	-	▶	3SX03-KL40	
	1.50 (38)	Nylatron	0.75 (19)	1.00 (25)	0.92	-	▶	3SX03-KL337	
		Ball bearing	0.69 (17)	0.25 (6)	0.77	-		3SX03-KL531	
		Without roller	-	-	0.32	-		3SX03-KL32	
	2.00 (51)	Nylatron	0.75 (19)	0.31 (8)	0.71	-	▶	3SX03-KL546	
Nylatron		0.75 (19)	1.00 (25)	1.45	-		3SX03-KL572		
Metal		0.75 (19)	0.31 (8)	1.5	-	▶	3SX03-KL549		
250 (64)	Ball bearing	0.69 (17)	0.25 (6)	1.1	-		3SX03-KL552		
	Nylatron	0.75 (19)	0.31 (8)	1.0	-		3SX03-KL547		
	Nylatron	0.75 (19)	1.00 (25)	1.8	-		3SX03-KL573		
	Nylatron	1.5 (38)	0.28 (7)	1.4	-		3SX03-KL575		
	Metal	0.75 (19)	0.31 (8)	2.0	-		3SX03-KL550		
Cast aluminum	Ball bearing	0.69 (17)	0.25 (6)	1.5	-	▶	3SX03-KL553		
	Nylatron	0.75 (19)	0.31 (8)	1.3	-	▶	3SX03-KL548		
	Nylatron	0.75 (19)	1.00 (25)	2.3	-	▶	3SX03-KL574		
	Nylatron	1.5 (38)	0.28 (7)	1.8	-	▶	3SX03-KL576		
	Metal	0.75 (19)	0.31 (8)	2.5	-	▶	3SX03-KL551		
3.00 (76)	Ball bearing	0.69 (17)	0.25 (6)	1.8	-		3SX03-KL554		

All dimensions shown in inches and (millimeters). For reference purposes only. Not to be used for design or construction purposes.

① Roller lever: Length from the operating shaft axis to the roller axis.
All other: Length from the operating shaft axis to the tip.

② Caution—When selecting lever, required return torque should not exceed minimum return torque in operating head.

③ Cap screw accommodates 3/64 inch Allen wrench.
④ By re-assembling lever minimum can be reduced another 0.50 (13).

⑤ Applies when lever extended to maximum dimension.

⑥ See dimensions page 13/76.







Limit Switches

3SE03 North American Limit Switches





Modular, plug-in and
NEMA type 6P submersible

1
2
3
4
5
6
7
8
9
10
11
12
13

Levers for plug-in and non-plug-in versions—most widely used

Operator	Length ^① Inches (mm)	Roller			Min. required return torque oz-in ^⑤	Catalog Number					
		Type	Diameter In. (mm)	Face width in. (mm)		DT	Stainless steel	Cast aluminum	List Price \$ 1 unit		
Roller levers											
	Roller on reverse side	1.50 (38)	Nylatron	0.75 (19)	0.31 (8)	0.53	▶	–	3SX03-KL310		
			Nylatron	1.5 (38)	0.28 (7)	0.96	–	–	3SX03-KL536		
			Ball bearing	0.69 (17)	0.25 (6)	0.77	–	–	3SX03-KL580		
	Offset lever (Inboard roller shown)	1.50 (38)	Inboard roller	Nylatron	0.75 (19)	0.31 (8)	0.65	▶	3SX03-KL24	–	
			Metal	0.75 (19)	0.31 (8)	1.20	▶	–	3SX03-KL25	–	
				Ball bearing	0.69 (17)	0.25 (6)	0.90	–	–	3SX03-KL26	–
		1.50 (38)	outboard roller	Nylatron	0.75 (19)	0.31 (8)	0.65	▶	–	3SX03-KL27	–
				Metal	0.75 (19)	0.31 (8)	1.20	–	–	3SX03-KL28	–
				Ball bearing	0.69 (17)	0.25 (6)	0.90	–	–	3SX03-KL29	–
Nylatron	0.75 (19)	1 (25)	1.10	–	–	3SX03-KL30	–				
	Bantam lever	0.69 (18)	Metal	0.88 (22)	0.19 (5)	0.45	▶	–	3SX03-KL532		
	Precision adjustment	1.50 (38) ^②	Nylatron	0.75 (19)	0.31 (8)	0.65	–	–	3SX03-KL340		
			Metal	0.75 (19)	0.31 (8)	1.20	–	–	3SX03-KL465		
			Ball bearing	0.69 (17)	0.25 (6)	0.90	▶	–	3SX03-KL535		
	Adjustable roller	1–3.75 (25–95) ^③ 1–3.75 (25–95) ^③ 1.62–3.75 (41–95) ^③ 0.50–3.75 (13–95) 1–3.75 (25–95) ^③ 0.50–3.75 (13–95)	Nylatron	0.75 (19)	0.5 (13)	1.90 ^④	▶	–	3SX03-KL599		
			Nylatron	0.75 (19)	1 (25)	3.10 ^④	▶	–	3SX03-KL537		
			Nylatron	1.5 (38)	0.28 (7)	2.50 ^④	▶	–	3SX03-KL443		
			Large nylatron	4 (102)	0.11 (3)	4.50 ^④	▶	–	3SX03-KL598		
			Ball bearing	0.69 (17)	0.25 (6)	2.50 ^④	–	–	3SX03-KL539		
			Without roller	–	–	1.20 ^④	–	–	3SX03-KL31		
	Fork lever _ both rollers one side	1.50 (38)	Nylatron	0.75 (19)	1 (25)	–	▶	–	3SX03-KL543		
			Metal	0.75 (19)	0.31 (8)	–	–	–	3SX03-KL544		
			Ball bearing	0.69 (17)	0.25 (6)	–	▶	–	3SX03-KL545		
	Fork lever _ both rollers outside, one side	1.50 (38)	Nylatron	0.75 (19)	0.31 (8)	–	▶	–	3SX03-KL203		
			Metal	0.75 (19)	0.31 (8)	–	–	–	3SX03-KL541		
			Ball bearing	0.69 (17)	0.25 (6)	–	–	–	3SX03-KL542		

Levers for plug-in and non-plug-in versions:

Operator		Length ^① Inches (mm)	Description Inches (mm)	Min. required return force oz-in. ^⑤	DT	Catalog Number	List Price \$ 1 unit
	Adjustable rod	5.50 (140) Max.	Nylon Rod—0.19 (5) Dia.	0.40 ^④	▶	3SX03-KL399	
		5.50 (140) Max.	Metal Rod—0.12 (3) Dia.	0.92 ^④	▶	3SX03-KL202	
		8.75 (222) Max.	Metal Rod (Square)—0.12 (3) Max.	2.20 ^④	▶	3SX03-KL581	
		12 (305) Max.	Steel (Formable) Rod—0.12 (3) Dia.	5.00 ^④	▶	3SX03-KL226	
		–	Clamp Only—0.19 (5) Hole	–	▶	3SX03-KL35	
		–	Clamp Only—0.12 (3) Hole	–	–	3SX03-KL36	
	Spring rod	11.62 (295)	Metal rod	2.80	–	3SX03-KL421	
	Adjustable wire	12.12 (308) max.	Nylon covered wire	1.50 ^④	▶	3SX03-KL533	
	Adjustable wide roller lever	3.9 (99)	0.75 (19) Dia. Nylatron Roller 0.19 (30) Dia. Rod	4.50 ^④	▶	3SX03-KL37	
Wobble head operators							
See dimensions page 13/76	Stainless steel rod	–	Rod diameter - 0.06 (2)	–	▶	3SX03-KW3	

① Length from operating shaft axis to the roller axis.

② Maximum dimensions, precision adjustable to lesser dimensions.

③ By re-assembling lever minimum can be reduced by 1/2 in.

④ Applies when lever extended to maximum dimension.

⑤ Caution—When selecting lever, required return torque should not exceed minimum return force in operating head.

All dimensions shown in inches and (millimeters). For reference purposes only. Not to be used for design or construction purposes.

Limit Switches

3SE03 North American Limit Switches

Modular, plug-in and
NEMA type 6P submersible

Wiring diagrams

Single Pole
1 NO - 1 NC

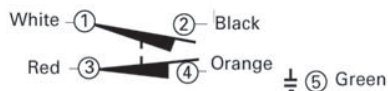

Double Pole
1 NO - 1 NC

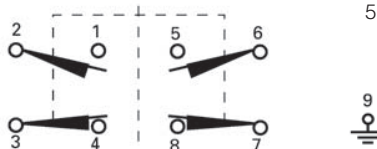

Cable color code
1 - White 6 - Pink
2 - Black 7 - Yellow
3 - Red 8 - Blue
4 - Orange 9 - Green
5 - Brown
Pre-wired cable

Modular, plug-in and prewired cable

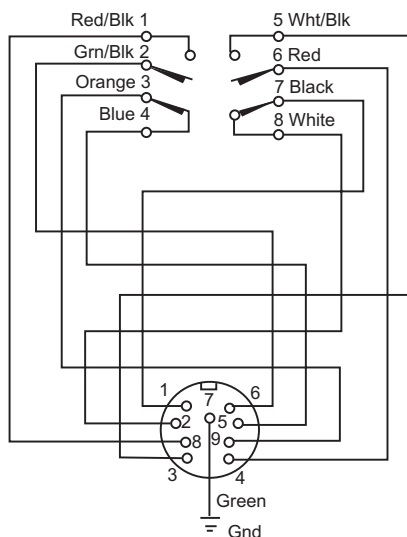
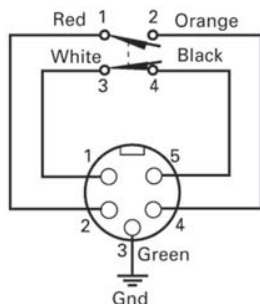

Prewired receptacle with pin connector

Typical connector cable (supplied by user)

Cable length ft.	Manufacturers part number			
	Daniel Woodhead Brad Harrison	Cooper Crouse-Hinds	Molex (Industrial Interface)	Lumberg USA
5 Pin connector cable				
3	105000A01F030	5000111-3_	14541	RK50-77/1M
6	105000A01F060	5000111-4_	14542	RK50-77/2M
12	105000A01F120	5000111-5_	14544	RK50-77/4M
9 Pin connector cable				
3	309000A01F030	X8990-3	-	-
6	309000A01F060	X8990-4	-	-
12	309000A01F120	X8990-5	-	-

Limit Switches

3SE03 North American Limit Switches

Modular, plug-in and NEMA type 6P submersible

1

2

3

4

5

6

7

8

9

10

11

12

13

Dimension drawings

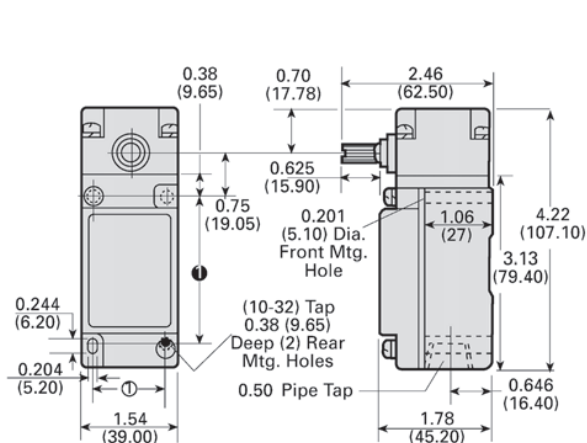

Plain side plunger

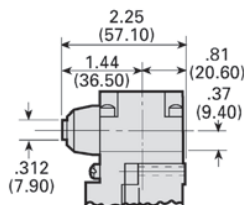

Roller side plunger

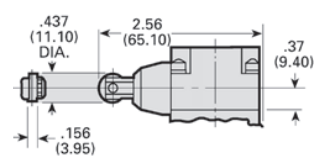

Two side plungers

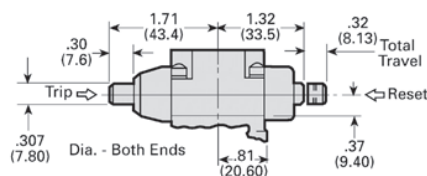

Plain top plunger

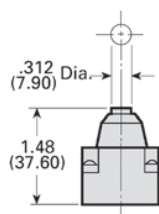

Roller top plunger

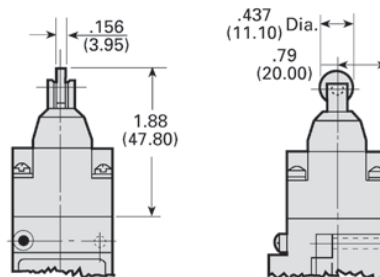

Rotary lever operators

Catalog Number	Dimensions						Catalog Number	Dimensions					
	A	B	C	D	E	F		A	B	C	D	E	F
3SX03-KL200	1.50 (38.1)	0.75 (19.0)	0.32 (8.1)	0.44 (11.2)	0.20 (5.1)	0.24 (6.1)	3SX03-KL554	3.00 (76.2)	0.688 (17.5)	0.25 (6.4)	0.42 (10.7)	0.12 (3.0)	0.18 (4.6)
3SX03-KL355	1.50 (38.1)	0.75 (19.0)	0.32 (8.1)	0.44 (11.2)	0.20 (5.1)	0.24 (6.1)	3SX03-KL572	2.00 (50.8)	0.75 (19.0)	1.00 (25.4)	0.42 (10.7)	0.90 (22.9)	0.90 (22.9)
3SX03-KL377	1.50 (38.1)	0.75 (19.0)	1.00 (25.4)	0.44 (11.2)	0.90 (22.9)	0.90 (22.9)	3SX03-KL573	2.50 (63.5)	0.75 (19.0)	1.00 (25.4)	0.42 (10.7)	0.90 (22.9)	0.90 (22.9)
3SX03-KL531	1.50 (38.1)	0.688 (17.5)	0.25 (6.4)	0.44 (11.2)	0.12 (3.0)	0.18 (4.6)	3SX03-KL574	3.00 (76.2)	0.75 (19.0)	1.00 (25.4)	0.42 (10.7)	0.90 (22.9)	0.90 (22.9)
3SX03-KL546	2.00 (50.8)	0.75 (19.0)	0.32 (8.1)	0.42 (10.7)	0.20 (5.1)	0.24 (6.1)	3SX03-KL575	2.50 (63.5)	1.50 (38.1)	0.29 (7.4)	0.42 (10.7)	0.18 (4.6)	0.24 (6.1)
3SX03-KL547	2.50 (63.5)	0.75 (19.0)	0.32 (8.1)	0.42 (10.7)	0.20 (5.1)	0.24 (6.1)	3SX03-KL576	3.00 (76.2)	1.50 (38.1)	0.29 (7.4)	0.42 (10.7)	0.18 (4.6)	0.24 (6.1)
3SX03-KL548	3.00 (76.2)	0.75 (19.0)	0.32 (8.1)	0.42 (10.7)	0.20 (5.1)	0.24 (6.1)	With rollers on reverse side						
3SX03-KL549	2.00 (50.8)	0.75 (19.0)	0.32 (8.1)	0.42 (10.7)	0.20 (5.1)	0.24 (6.1)	3SX03-KL310	1.50 (38.1)	0.75 (19.0)	0.32 (8.1)	0.44 (11.2)	0.34 (8.6)	0.38 (9.7)
3SX03-KL550	2.50 (63.5)	0.75 (19.0)	0.32 (8.1)	0.42 (10.7)	0.20 (5.1)	0.24 (6.1)	3SX03-KL536	1.50 (38.1)	1.50 (38.1)	0.28 (7.1)	0.44 (11.2)	0.30 (7.6)	0.38 (9.7)
3SX03-KL551	3.00 (76.2)	0.75 (19.0)	0.32 (8.1)	0.42 (10.7)	0.20 (5.1)	0.24 (6.1)	3SX03-KL579	1.50 (38.1)	0.75 (19.0)	0.32 (8.1)	0.44 (11.2)	0.34 (8.6)	0.38 (9.7)
3SX03-KL552	2.00 (50.8)	0.688 (17.5)	0.25 (6.4)	0.42 (10.7)	0.12 (3.0)	0.18 (4.6)	3SX03-KL580	1.50 (38.1)	0.688 (17.5)	0.25 (6.4)	0.44 (11.2)	0.25 (6.4)	0.31 (7.9)
3SX03-KL553	2.50 (63.5)	0.688 (17.5)	0.25 (6.4)	0.42 (10.7)	0.12 (3.0)	0.18 (4.6)							

All dimensions shown in inches and (millimeters). For reference purpose only. Not to be used for design or construction purposes.

① Can accommodate both U.S. 1.16 (29.4) x 2.34 (59.5) and DIN 1.18 (30.0) x 2.36 (60.0) mounting dimensions.

Limit Switches

3SE03 North American Limit Switches

Modular, plug-in and
NEMA type 6P submersible

Dimension drawings

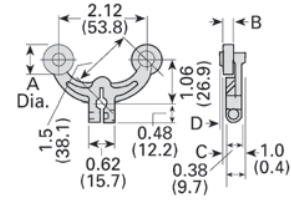
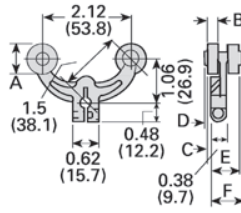
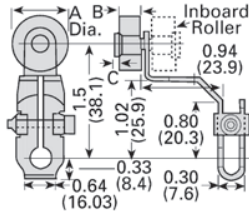

Offset roller levers

Catalog Number	Dimensions		
	A	B	C
Outboard roller			
3SX03-KL27	0.75 (19)	0.32 (8)	0.03 (1)
3SX03-KL28	0.75 (19)	0.32 (8)	0.03 (1)
3SX03-KL29	0.69 (18)	0.25 (6)	0.04 (1)
3SX03-KL30	0.75 (19)	1.0 (25)	—
Inboard roller			
3SX03-KL24	0.75 (19)	0.32 (8)	0.03 (1)
3SX03-KL25	0.75 (19)	0.32 (8)	0.03 (1)
3SX03-KL26	0.69 (18)	0.25 (6)	0.04 (1)

Fork lever, one roller inside, one roller outside

Catalog Number	Dimensions					
	A	B	C	D	E	F
3SX03-KL203	0.75 (19)	0.32 (8)	0.16 (4)	0.20 (5)	0.73 (19)	0.77 (20)
3SX03-KL541	0.75 (19)	0.32 (8)	0.16 (4)	0.20 (5)	0.73 (19)	0.77 (20)
3SX03-KL542	0.69 (18)	0.25 (6)	0.08 (2)	0.14 (4)	0.64 (16)	0.70 (18)

Fork lever - Both rollers on one side

Catalog Number	Dimensions			
	A	B	C	D
3SX03-KL204	0.75 (19)	0.32 (8)	0.16 (4)	0.20 (5)
3SX03-KL543	0.75 (19)	1.0 (25)	0.86 (22)	0.86 (22)
3SX03-KL544	0.75 (19)	0.32 (8)	0.16 (4)	0.20 (5)
3SX03-KL545	0.69 (18)	0.25 (6)	0.08 (2)	0.1 (3)

Bantam roller lever

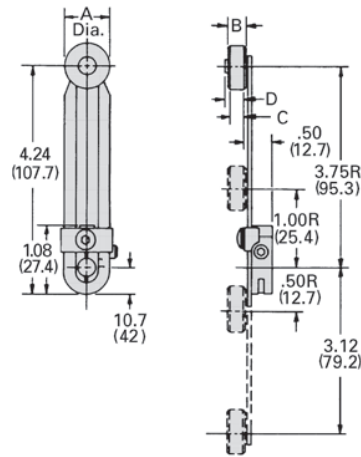
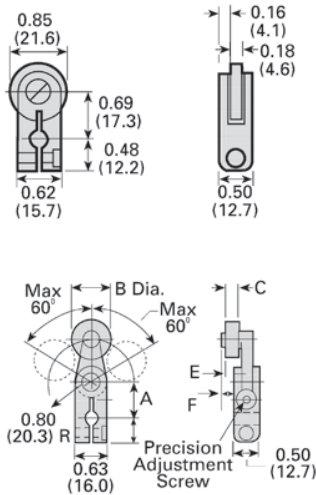

Precision adjustment roller lever

Catalog Number	Dimensions					
	A	B	C	D	E	F
3SX03-KL340	0.69 (18)	0.75 (19)	0.32 (8)	0.48 (12)	0.24 (6)	0.28 (7)
3SX03-KL465	0.69 (18)	0.75 (19)	0.32 (8)	0.48 (12)	0.24 (6)	0.28 (7)
3SX03-KL535	0.69 (18)	0.69 (18)	0.25 (6)	0.48 (12)	0.16 (4)	0.22 (6)

Adjustable roller lever

Catalog Number	Dimensions			
	A	B	C	D
3SX03-KL201	0.75 (19)	0.32 (8)	0.29 (7)	0.33 (8)
3SX03-KL443	1.5 (38)	0.29 (7)	0.26 (7)	0.32 (8)
3SX03-KL537	0.75 (19)	0.32 (8)	0.29 (7)	0.33 (8)
3SX03-KL538	0.69 (18)	0.25 (6)	0.21 (5)	0.27 (7)
3SX03-KL539	0.69 (18)	0.25 (6)	0.21 (5)	0.27 (7)
3SX03-KL598	0.39 (10)	0.11 (3)	0.11 (3)	0.19 (5)
3SX03-KL599	0.75 (19)	0.5 (13)	0.46 (12)	0.47 (12)

All dimensions shown in inches and (millimeters). For reference purposes only. Not to be used for design or construction purposes.

1

2

3

4

5

6

7

8

9

10

11

12

13

Dimension drawings

Nylon Spring Rod Actuator
3SX03-KL556

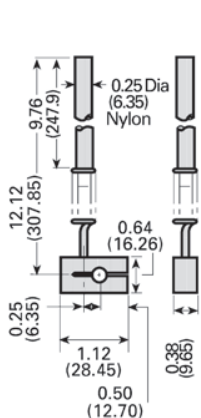

Nylon Covered Wire Actuator
3SX03-KL533

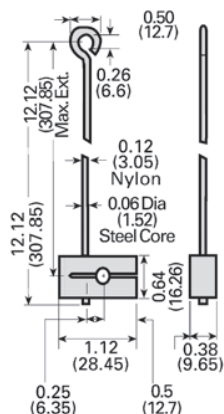

Stainless Steel Spring Actuator
3SX03-KL421

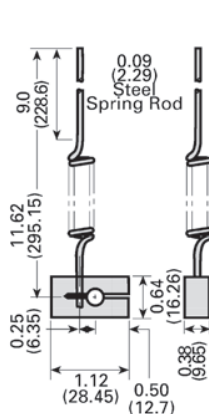

Adjustable Rod Actuator

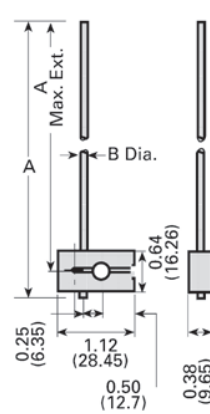

Adjustable Wire Roller Actuator
3SX03-KL37

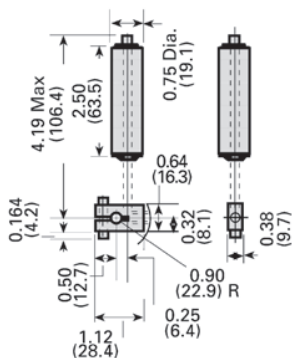

Nylatron Loop Actuator
3SX03-KL142

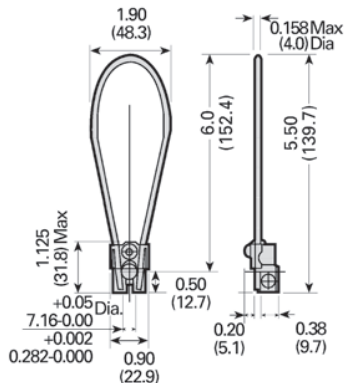

Adjustable rod actuators

Catalog Number	Material	Dimensions	
		A	B
3SX03-KL202	Steel-Round	5.50 (140)	0.120 (3)
3SX03-KL581	Steel-Square	8.75 (222)	0.125 (3)
3SX03-KL399	Nylon	5.50 (140)	0.190 (5)
3SX03-KL220	Stainless Steel	9.00 (229)	0.190 (5)
3SX03-KL226	Plated Steel	12.0 (305)	0.120 (3)

Wobble head with nylon head
3SE03-DW1
3SX03-KW2

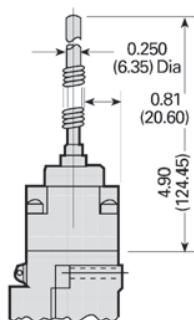

Wobble head with coil spring
3SE03-DW1
3SX03-KW4

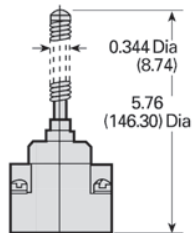

Wobble head with stainless steel rod
3SE03-DW1
3SX03-KW3

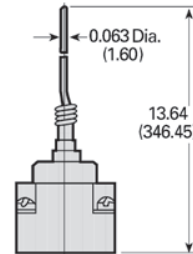

All dimensions shown in inches and (millimeters). For reference purposes only. Not to be used for design or construction purposes.

Limit Switches

3SE03 North American Limit Switches

3SE03 Metal enclosure

Description

Features

- NEMA 1 Enclosed Aluminum Die Cast Housing
- Screw Terminals
- Booted versions for added protection

- 1/2" Conduit Entrance
- NEMA A600, R300 Contacts
- UL Recognized
- CSA Certified
- INO/INC Snap-action contacts (form c)

Application

These switches are designed for accurate repeatability. Their compact size makes them ideal for use in space-restricted areas.

Typical applications include overhead, folding and elevator doors, sliding gates and other automated equipment.

Overall dimensions

Specifications [ⓐ]

DT

Catalog Number

List Price \$ 1 unit

Plunger actuator

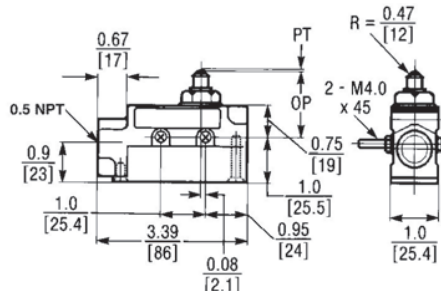

OF Max. - 8.82 - 12.3 oz.
(250 - 350 g)
RF Min. 4.02 oz. (114 g)
PT Max. - 0.016 in. (0.4 mm)
OT Min. - 0.217 in. (5.5 mm)
MD Max. - 0.002 in. (0.05 mm)
OP - 1.504 in. (38.2 mm)



3SE03 - EB05

Booted plunger

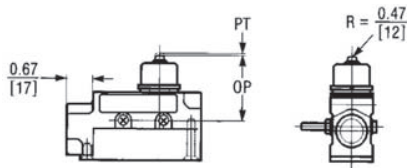

OF Max. - 28.22 oz. (800 g)
RF Min. 8.46 oz. (240 g)
PT Max. - 0.079 in. (2.0 mm)
OT Min. - 0.197 in. (5.0 mm)
MD Max. - 0.004 in. (0.1 mm)
OP - 1.803 in. (45.8 mm)



3SE03 - EB06

Roller lever

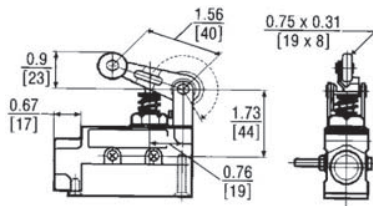

OF Max. - 20.1 oz. (570 g)
RF Min. 6.0 oz. (170 g)
PT Max. - 0.157 in. (4.0 mm)
OT Min. - 0.236 in. (6.0 mm)
MD Max. - 0.016 in. (0.4 mm)



3SE03 - EB32

Booted roller lever

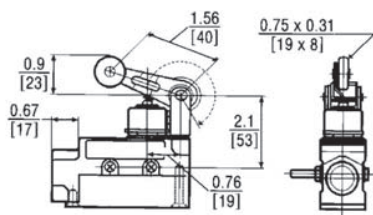

OF Max. - 22.57 oz. (640 g)
RF Min. 8.11 oz. (230 g)
PT Max. - 0.197 in. (5.0 mm)
OT Min. - 0.236 in. (6.0 mm)
MD Max. - 0.016 in. (0.4 mm)



3SE03 - EB33

[ⓐ] OF = Operating Force
RF = Return Force
PT = Pretravel
OT = Operating Travel
MD = Movement Differential
OP = Operating Position

Limit Switches

3SE03 North American Limit Switches

3SE03 Metal enclosure

1
2
3
4
5
6
7
8
9
10
11
12
13

Dimension drawings

Overall dimensions

Roller plunger

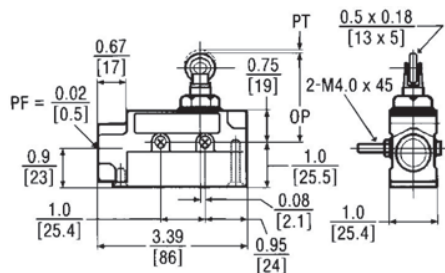

OF Max. - 9.92 - 12.3 oz.
(250 - 350 g)
RF Min. 4.02 oz. (114 g)
PT Max. - 0.02 in. (0.5 mm)
OT Min. - 0.142 in. (3.6 mm)
MD Max. - 0.002 in. (0.05 mm)
OP - 1.957 in. (49.7 mm)



3SE03 - EB07

Booted roller plunger

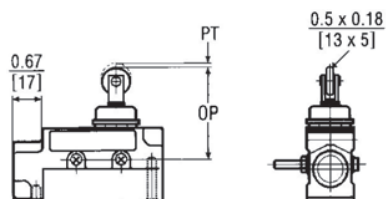

OF Max. - 17.64 oz. (500 g)
RF Min. 3.53 oz. (100 g)
PT Max. - 0.039 in. (1.0 mm)
OT Min. - 0.138 in. (3.5 mm)
MD Max. - 0.006 in. (0.12 mm)
OP - 1.957 in. (49.7 mm)



3SE03 - EB08

Technical data

Mechanical Life	3,000,000 operations maximum							
Electrical Life	500,000 operations minimum							
Operating Speed	0.01 m/second to 1m/second							
Cable Entry	1/2" NPT							
Temperature Range	-15° to 80° (5° to 176°F)							
Degree of Protection	NEMA 1							
Mounting	Any Position							
NEMA Rating	A600, R300							
Rated Voltage (V)¹⁾²⁾	Non-Inductive Load (A)			Inductive load (A)			Inrush current (A)	
	Resistive load		Lamp load	Inductive load		Motor load		
	NC-NO	NO	NC	NC-NO	NO	NC	NO	NC
125 VAC	15	3	1.5	15	5	2.5	30 maximum	15 maximum
250 VAC	15	2.5	1.25	15	3	1.5		
500 VAC	3	1.5	0.75	2.5	1.5	0.75		
8 VDC	15	3	1.5	15	5	2.5		
14 VDC	15	3	1.5	10	5	2.5		
30 VDC	6 (2)	3	1.5	5	5	2.5		
125 VDC	0.4	0.4	0.4	0.05	0.05	0.05		
250 VDC	0.2	0.2	0.2	0.03	0.03	0.03		

1) Inductive load has power factor of 0.04 minimum (AC) and a time of 7m/second (DC)

2) Lamp load has an inrush current of 6 times steady-state current.

Mechanical Safety

3SE7 Cable-Operated Switches

General Information

Application

Cable-operated switches are used for monitoring or for EMERGENCY-STOP facilities on particularly endangered system sections. They are available with metal enclosures.

As the effective range of a cable-operated switch is limited by the length of the pull-wire, large systems can also be protected.

Cable-operated switches (requiring pulling at both ends) and conveyor belt unbalance trackers are used primarily for monitoring very long belt systems.

Specifications

Switches with latching for implementation in EMERGENCY-STOP equipment correspond to the EN 418 standard.

Principle of operation

The switch contacts of the cable-operated switches and the conveyor belt unbalance protection devices are positive opening.

Cable-operated switches with one-side operation are held in free position by the pre-tension force on the turnbuckle.

- In the 3SE7 140, -150 and -160 cable-operated switches, both switching contacts are available for cable-break/cable pull signaling. The NO contact is used, for example, for signaling purposes.

For switches with latching, with a pretensioned cable, the locking must be deactivated beforehand in order to return the switch to its free position.

Technical data

Type	3SE7 120	3SE7 150	3SE7 140	3SE7 141	3SE7 160	3SE7 310
Standards	IEC 60947-5-1, EN 60947-5-1; IEC 60204-1, EN 60204-1; EN ISO 13850					
Certifications	UL / CSA					
Electrical design	Contacts electrically isolated from each other					
Electrical loading	<ul style="list-style-type: none"> at AC-15 minimum 					
	AC 400 V, 6A			AC 250 V, 2A	AC 400 V, 6A	
	AC/DC 24 V, 10 mA					
Short circuit protection	6 A (Slow acting)					
Mechanical endurance	> 1 x 10 ⁶ operating cycles					
Contact material	Fine silver					
Actuation	By pulling or breaking of a rope (cable)					
Rope length, maximum	10 m	25 m	50 m	75 m ¹⁾	2 x 50 m	–
Spacing between rope supports, maximum	2.5 m	3 m	5 m	5 m	5 m	–
Enclosure	GDAL alloy, coated (color), dark black RAL 9005					
Cover	Shock-resistant thermoplastic					
Degree of protection acc. To IEC 60529	IP65			IP67	1P65	
Ambient temperature	-25C to +70C					
Mounting	Designed for M 5					
Mounting space	30 mm and 40 mm					
Cable entry	2x(M20x1.5)	2x(M20x1.5)	1x(M16x1.5)	3x(M20x1.5)	2x(M25x1.5)	
Type of connection	M3.5 screw connection; Self-lifting pressure plate terminals					

Travel diagrams

3SE7 120-2DD01

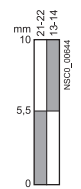

NSC0_00645

Central position

3SE7 140-1.F00

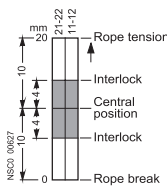

NSC0_00629

Central position

3SE7 141-1EG10

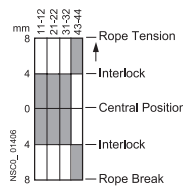

NSC0_01406

Central position

3SE7 140-1.D0.

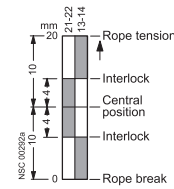

NSC000293

Central position

3SE7 120-1BF00, 3SE7 150-1BF00

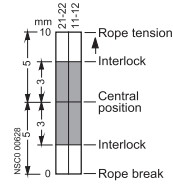

NSC0_00629

Central position

3SE7 160-1AE, 3SE7 310-1AE

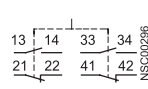
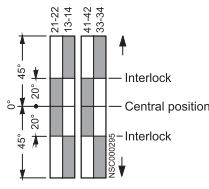

NSC000296

Central position

3SE7 150-1.D00, 3SE7 150-2DD00

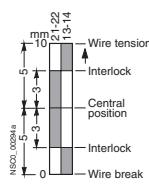

NSC000293

Central position

1) 75 m cable length possible provided the ambient temperature range is strictly observed, otherwise, 50 m.

Mechanical Safety

SIRIUS 3SE7 Cable-Operated Switches

Selection

1
2
3
4
5
6
7
8
9
10
11
12
13

Selection and ordering data

Version	Wire length	Contacts	DT	Order No.	Price per PU	PU (UNIT, SET, M)	PS*	
Cable-operated switches								
 3SE7 120-1BH00	Metal enclosures, IP65 (cover made of molded plastic)	10						
		<ul style="list-style-type: none"> Without latching, only cable pull monitoring 	1 NO + 1 NC	↻	A	3SE7 120-2DD01	1	1 unit
		<ul style="list-style-type: none"> With latching and button reset - With yellow lid 	2 NC 1 NO + 2 NC	↻ ↻	A A	3SE7 120-1BF00 3SE7 120-1BH00	1 1	1 unit 1 unit
 3SE7 150-1BD00 3SE7 150-1BH00	Metal enclosures, IP65 (cover made of molded plastic), with alignment window	25						
		<ul style="list-style-type: none"> Without latching 	1 NO + 1 NC	↻	A	3SE7 150-2DD00	1	1 unit
		<ul style="list-style-type: none"> With latching and button reset 	1 NO + 1 NC	↻	▶	3SE7 150-1BD00	1	1 unit
		<ul style="list-style-type: none"> - With yellow lid 	2 NC	↻	▶	3SE7 150-1BF00	1	1 unit
		<ul style="list-style-type: none"> With latching and key unlatching 	1 NO + 2 NC 1 NO + 1 NC	↻ ↻	▶ B	3SE7 150-1BH00 3SE7 150-1CD00	1 1	1 unit 1 unit
 3SE7 150-1BD04	Metal enclosures, IP65 (cover made of molded plastic), with alignment window, with LED, red, 24 V DC	25						
		<ul style="list-style-type: none"> Without latching With latching and button reset 	1 NO + 1 NC 1 NO + 1 NC	↻ ↻	B ▶	3SE7 150-2DD04 3SE7 150-1BD04	1 1	1 unit 1 unit
 3SE7 140-1B.00	Metal enclosures, IP65 (cover made of molded plastic)	50						
		<ul style="list-style-type: none"> With latching and button reset 	1 NO + 1 NC	↻	A	3SE7 140-1BD00	1	1 unit
		<ul style="list-style-type: none"> - In addition with LED, red, 24 V DC 	2 NC	↻	▶	3SE7 140-1BF00	1	1 unit
		<ul style="list-style-type: none"> With latching and key unlatching 	1 NO + 1 NC 1 NO + 1 NC	↻ ↻	B B	3SE7 140-1BD04 3SE7 140-1CD00	1 1	1 unit 1 unit
 3SE7 141-1EG10	Metal enclosures, IP67 (cover made of molded plastic), with EMERGENCY-STOP mushroom, with rotate-to-unlatch mechanism	75						
 3SE7 160-1AE00	Metal enclosures, IP65 with actuation on both sides	2 × 75						
		<ul style="list-style-type: none"> With latching and button reset 	2 NO + 2 NC	↻	A	3SE7 160-1AE00	1	1 unit
		<ul style="list-style-type: none"> - In addition with LED, red, 24 V DC 	1 NO + 1 NC 2 NO + 2 NC	↻ ↻	B B	3SE7 160-1BD00 3SE7 160-1AE04	1 1	1 unit 1 unit

↻ Positive opening according to IEC 60947-5-1, Appendix K.

Mechanical Safety

SIRIUS 3SE7 Cable-Operated Switches

Selection

Version	Contacts	DT	Order No.	Price per PU	PU (UNIT, SET, M)	PS*
---------	----------	----	-----------	--------------	-------------------	-----

Conveyor belt unbalance trackers



3SE7 310-1AE00

Metal enclosures, IP65

- With latching and button reset
- In addition with LED, red, 24 V DC

2 NO + 2 NC ⤴ B
2 NO + 2 NC ⤴ B

3SE7 310-1AE00
3SE7 310-1AE04

1 1 unit
1 1 unit

⤴ Positive opening according to IEC 60947-5-1, Appendix K.

Product Category: SFTY

Accessories

Configuration of the cable-operated switches

Short lengths of wire up to 25 m

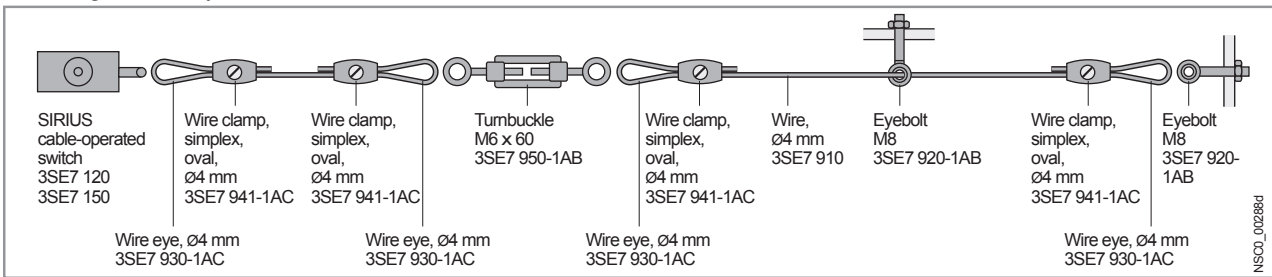

Long lengths of wire up to 50 m

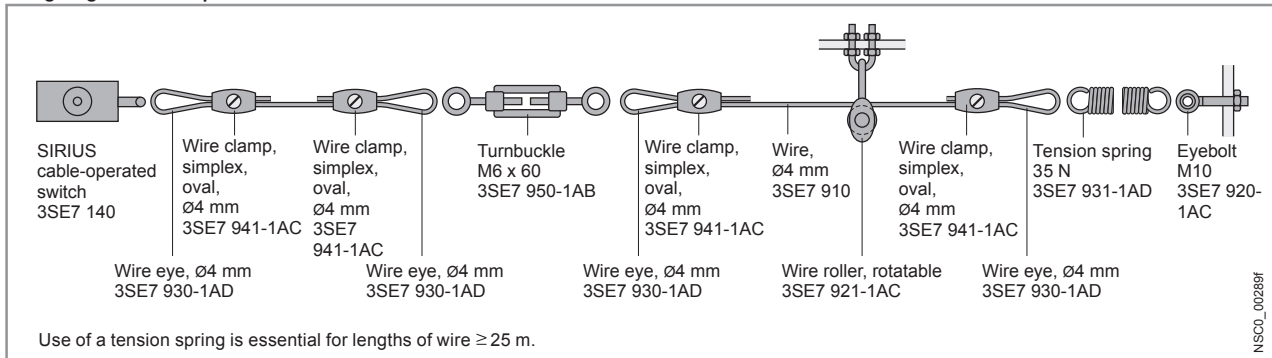

Pulling from both sides up to 2 x 75 m

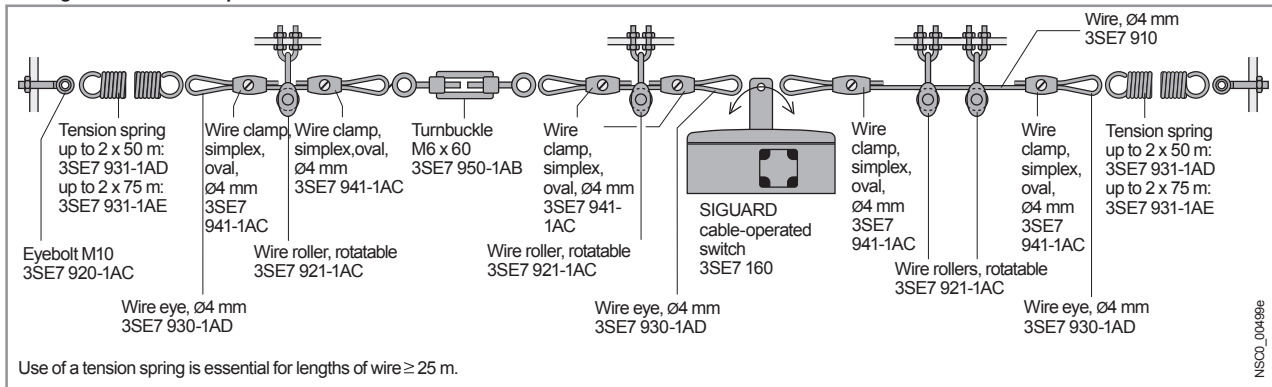

Note:

Large temperature fluctuations require corresponding compensation springs. For reliable connection the PVC sheath must be

removed from the clamping area of the steel trip-wire. Wire supports must be used at the recommended intervals.

Mechanical Safety

SIRIUS 3SE7 Cable-Operated Switches

Accessories

1

2

3

4

5

6

7

8









9

10

11

12

13

Version	Wire length/ diameter	DT	Order No.	Price per PU	PU (UNIT, SET, M)	PS*
Trip-wire with fixing						
	Steel wires , with red plastic sheath, Ø 4 mm ¹⁾	10 m	A	3SE7 910-3AA	1	1 unit
		15 m	A	3SE7 910-3AB	1	1 unit
		20 m	▶	3SE7 910-3AC	1	1 unit
		50 m	A	3SE7 910-3AH	1	1 unit
	Wire clamps , galvanized white					
	• Oval	2 × Ø 4 mm	A	3SE7 941-1AC	1	1 unit
	• Simplex (1 set = 4 units)	2 × Ø 4 mm	▶	3SE7 943-1AC	1	4 units
	• Duplex (1 set = 4 units)	2 × Ø 4 mm	A	3SE7 944-1AC	1	4 units
	• Single (1 set = 4 units)	2 × Ø 4 mm	A	3SE7 942-1AA	1	4 units
	Tension springs (zinc-plated) to maintain the counter tension					
	• 13 N		A	3SE7 931-1AB	1	1 unit
	• 35 N, for trip-wires up to 50 m		▶	3SE7 931-1AD	1	1 unit
	• > 35 N, for trip-wires up to 2 × 75 m		▶	3SE7 931-1AE	1	1 unit
	Wire rollers for changing the direction of the wire, Ø 4 mm rotatable		A	3SE7 921-1AC	1	1 unit
	Fixtures for the wire rollers (incl. fixing nuts)		▶	3SE7 921-1AA	1	1 unit
	Wire eyes for changes in wire direction and improved power transmission at the fixing points (1 set = 4 units)	Ø 4 mm	▶	3SE7 930-1AD	1	4 units
	Eyebolts for fixing the wire					
	• Including M8 nut		A	3SE7 920-1AB	1	1 unit
	• Including M10 nut		▶	3SE7 920-1AC	1	1 unit
	Turnbuckles for precise adjustment of the pretension					
	• M6 × 60		A	3SE7 950-1AB	1	1 unit
	• M6 × 110		A	3SE7 950-1AD	1	1 unit
Spare parts						
	LED lamps , red 24 V DC 25 mm diameter; for M20 × 1.5 connection		D	3SX3 235	1	1 unit

¹⁾ Diameter including casing; the diameter of the steel wire is 3.2 mm.

3SE Mechanical Safety

Cable-Operated Switches

3SE7, metal enclosures

Dimension drawings

Metal enclosure

3SE7 120-2DD.., 3SE7 150-2DD..
without latching

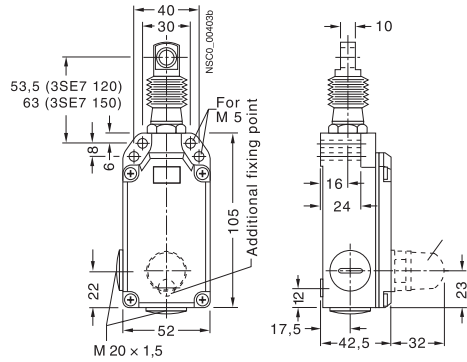

3SE7 120-1B..., 3SE7 150-1B...
with latching and button reset

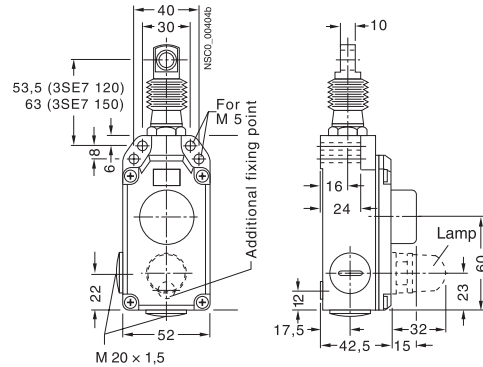

Metal enclosure

3SE7 140-1B...
with latching and button reset

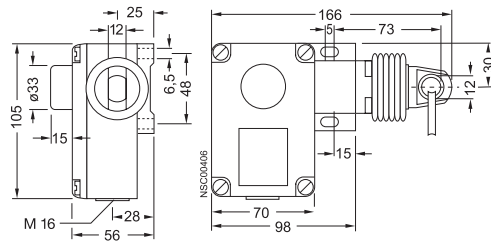

3SE7 140-1ECD.
with latching and key reset

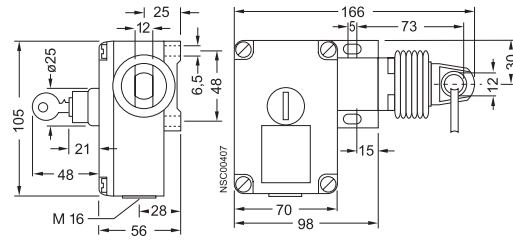

Metal enclosure

3SE7 150-1CD..
with latching and key reset

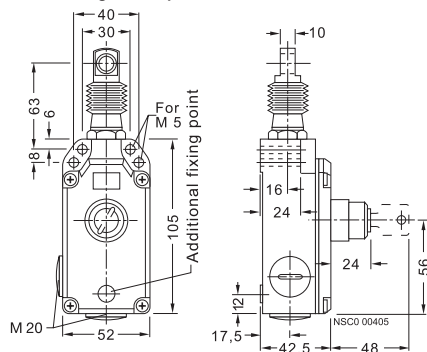

3SE7 141-1EG10.
with EMERGENCY STOP and Lockout release

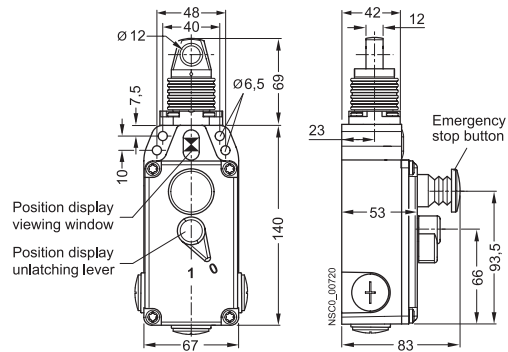

3SE7 160-1AE..
with latching and button reset

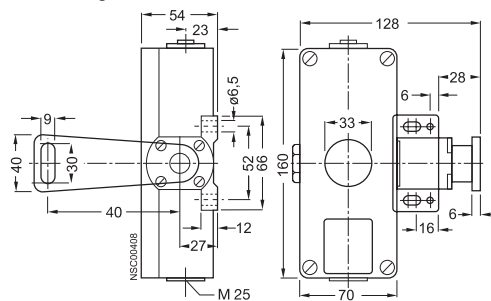

3SE7 310-1AE.. conveyor belt unbalance protection device
with latching and button reset

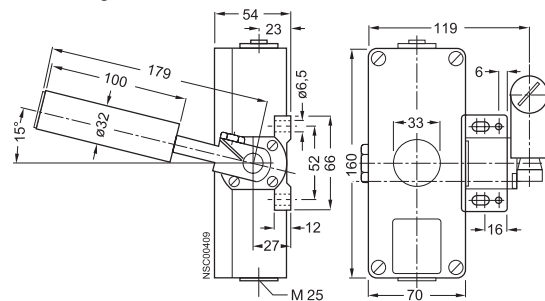

Overview

Position switches with separate actuator are used where the position of doors, covers or protective grills must be monitored for safety reasons.

3SE5 position switches with separate actuator have the same enclosures as the standard switches (modular system).



Position switches with head for separate actuator

Design

Enclosure sizes

The 3SE5 switches are available in various enclosure sizes:

- Plastic enclosures according to EN 50047, 31 mm wide, IP65, 1 cable entry
- Metal enclosures according to EN 50047, 31 mm wide, IP66/IP67, 1 cable entry
- Plastic and metal enclosures according to EN 50041, 40 mm wide, IP66/IP67, 1 cable entry
- Plastic enclosures, 50 mm wide, IP66/IP67, 2 cable entries
- Metal enclosures, 56 mm wide, IP66/IP67, 3 cable entries

Also available is a switch in the 3SE2 series which has arisen in this form according to general market requirements:

- Molded-plastic enclosures outside of the standards, enclosure width 52 mm, IP67

Enclosure versions

Various basic versions can be selected for the enclosures of the 3SE5 series:

- Available with two- or three-pole contact blocks designed as slow-action contacts
- Optional LED status display
- With mounted four- or five-pole M12 connector socket (available for the wide enclosures as an accessory for self-assembly)
- With 6-pole connector socket + PE on the metal enclosures
- Similarly with a combination of connector socket and LED indicators
- Metal enclosures for explosion protection (ATEX) ([see online](#))
- AS-Interface version with integrated ASIsafe electronics for all enclosure designs ([see online](#))

For a description of the basic switches, [see page 13/6](#).

Operation

The actuator head is included in the scope of supply. For actuation from four directions it can be adjusted through $4 \times 90^\circ$. The switches can also be approached from above.

The twist actuators of the 3SE2 243 and 3SE2 257 switches with special enclosures cannot be changed. The switches can be approached from the two broad sides and from above.

The actuators are not included in the scope of supply of the position switch and must be ordered separately from various versions to suit the application ([see page 13/86](#)).

The actuator is encoded. Simple overruling by hand or auxiliary devices is impossible.

Radius actuators

The position switches with radius actuators are particularly suitable for rotatable protective devices. The movable actuation key allows even small radii to be approached. Damage to the switch and the actuator due to inaccurate approach is prevented.

Locking devices

A high-grade steel blocking insert for attaching up to eight padlocks is available for even more safety ([see page 13/86](#)).



Blocking insert with padlock

Dust protection

A rubber cap to protect the twist actuator from contamination is available for operation in dusty environments ([see page 13/86](#)).

Contact reliability

The new contact blocks ensure an extremely high contact stability. This applies even when the devices are switching low voltages and currents, e.g. 1 mA at 5 V DC.

Positive opening

The NC contacts of the switch are forced open mechanically, positively-driven and reliably by the plunger. This is referred to as "positive opening".

Limit Switches





SIRIUS 3SE5 Interlock Switches

3SE5, plastic enclosures
with separate actuator

Selection and ordering data

Complete units

2 or 3 contacts · 5 directions of approach · Degree of protection IP65 or IP66/IP67 · Cable entry M20 × 1.5

Version ¹⁾	Contacts	LEDs	DT	Complete units	PU (UNIT, SET, M)	PS*	PG	Weight per PU approx.	
				Order No.	List Price \$ per PU			kg	
Enclosure width 31 mm to EN 50047									
	5 directions of approach								
	Slow-action contacts	1 NO + 1 NC --	⊕ ▶	3SE5 232-0RV40		1	1 unit	102	0.150
	Slow-action contacts	1 NO + 2 NC --	⊕ ▶	3SE5 232-0QV40		1	1 unit	102	0.155
	With increased minimum pull-out force 30 N								
	Slow-action contacts	1 NO + 1 NC --	⊕ B	3SE5 232-0QV40-1AA1		1	1 unit	102	0.150
	With M12 connector socket, 4-pole (250 V, 4 A)								
	Slow-action contacts	1 NO + 1 NC --	⊕ B	3SE5 234-0RV40-1AC4		1	1 unit	102	0.165
	Slow-action contacts	1 NO + 2 NC --	⊕ B	3SE5 234-0QV40-1AE0		1	1 unit	102	0.170
	With 2 LEDs, yellow/green								
	Slow-action contacts	1 NO + 1 NC 24 V DC	⊕ B	3SE5 232-1RV40		1	1 unit	102	0.155
	Slow-action contacts	1 NO + 1 NC 230 V AC	⊕ B	3SE5 232-3RV40		1	1 unit	102	0.110
	With M12 connector socket, 5-pole (125 V, 4 A) and 2 LEDs								
	Slow-action contacts	1 NO + 1 NC 24 V DC	⊕ C	3SE5 234-1RV40-1AF3		1	1 unit	102	0.175
Enclosure width 50 mm									
	5 directions of approach								
	Slow-action contacts	1 NO + 2 NC --	⊕ B	3SE5 242-0QV40		1	1 unit	102	0.110
	With increased minimum pull-out force 30 N								
	Slow-action contacts	1 NO + 1 NC --	⊕ B	3SE5 242-0RV40-1AA1		1	1 unit	102	0.110
	With 2 LEDs, yellow/green								
	Slow-action contacts	1 NO + 2 NC 24 V DC	⊕ B	3SE5 242-1QV40		1	1 unit	102	0.120
	Slow-action contacts	1 NO + 2 NC 230 V AC	⊕ C	3SE5 242-3QV40		1	1 unit	102	0.120

⊕ Positive opening according to IEC 60947-5-1, Appendix K.

1) Supplied without actuator. Please order separately (see page 13/86).

For 1/2" NPT adaptors and cable glands, see page 13/48.

Mechanical Safety

SIRIUS 3SE5 Interlock Switches

3SE5, plastic enclosures
Enclosure width 40 mm acc. to EN 50041

1
2
3
4
5
6
7
8
9
10
11
12
13

Selection and ordering data

Complete units

2 or 3 contacts · 5 directions of approach · Degree of protection IP66/IP67 · Cable entry M20 × 1.5

Version ¹⁾	Contacts	LEDs	DT	Complete units	Configurator	Order No.	Price per PU	PU (UNIT, SET, M)	PS*

Enclosure width 40 mm acc. to EN 50041



With separate actuator

5 directions of approach

Slow-action contacts	1 NO + 2 NC	—	↻ B	3SE5 132-0QV20	1	1 unit
----------------------	-------------	---	-----	-----------------------	---	--------



With 2 LEDs

With 2 LEDs, yellow/green

Slow-action contacts	1 NO + 2 NC	24 V DC	↻ C	3SE5 132-1QV20	1	1 unit
Slow-action contacts	1 NO + 2 NC	230 V AC	↻ C	3SE5 132-3QV20	1	1 unit

For online configurator see www.siemens.com/sirius/configurators.

Positive opening according to IEC 60947-5-1, Appendix K.

1) Supplied without actuator. Please order separately (see page 13/86).

Limit Switches

SIRIUS 3SE5 Interlock Switches

3SE5, metal enclosures
Enclosure width 31 mm acc. to EN 50047

Selection and ordering data

Complete units

2 or 3 contacts · 5 directions of approach · Degree of protection IP66/IP67 · Cable entry M20 × 1.5

Version ¹⁾	Contacts	LEDs	DT	Complete units	PU (UNIT, SET, M)	PS*
				Order No.	Price per PU	

Enclosure width 31 mm acc. to EN 50047



With separate actuator

5 directions of approach

Slow-action contacts	1 NO + 1 NC	—	↻ A	3SE5 212-0RV40	1	1 unit
Slow-action contacts	1 NO + 2 NC	—	↻ B	3SE5 212-0QV40	1	1 unit



With 2 LEDs

With 2 LEDs, yellow/green

Slow-action contacts	1 NO + 1 NC	24 V DC	↻ B	3SE5 212-1RV40	1	1 unit
Slow-action contacts	1 NO + 1 NC	230 V AC	↻ B	3SE5 212-3RV40	1	1 unit

For online configurator see www.siemens.com/sirius/configurators.

Positive opening according to IEC 60947-5-1, Appendix K.

1) Supplied without actuator. Please order separately (see page 13/86).

Mechanical Safety

SIRIUS 3SE5 Interlock Switches

3SE5, metal enclosures
with separate actuator

1
2
3
4
5
6
7
8
9
10
11
12
13



Selection and ordering data

Complete units



2 or 3 contacts · 5 directions of approach · Degree of protection IP66/IP67 · Cable entry M20 × 1.5

Version ¹⁾	Contacts	LEDs	DT	Complete units	PU (UNIT, SET, M)	PS*	PG	Weight per PU approx.
				Order No.	List Price \$ per PU			kg

Enclosure width 40 mm to EN 50041

	5 directions of approach							
	Slow-action contacts	1 NO + 2 NC --	⊕ ▶	3SE5 112-0QV10	1	1 unit	102	0.360
	With increased minimum pull-out force 30 N							
	Slow-action contacts	1 NO + 2 NC --	⊕ B	3SE5 112-0QV10-1AA7	1	1 unit	102	0.360
	With M12 connector socket, 5-pole (125 V, 4 A)							
	Slow-action contacts	1 NO + 1 NC --	⊕ C	3SE5 114-0RV10-1AC5	1	1 unit	102	0.360
	Slow-action contacts	2 NC --	⊕ C	3SE5 114-0QV10-1AE1	1	1 unit	102	0.360
	With connector socket, 6-pole + PE (250 V, 10 A)							
	Slow-action contacts	1 NO + 2 NC --	⊕ C	3SE5 115-0QV10-1AD1	1	1 unit	102	0.380
	With 2 LEDs, yellow/green							
	Slow-action contacts	1 NO + 2 NC 24 V DC	⊕ B	3SE5 112-1QV10	1	1 unit	102	0.370
	Slow-action contacts	1 NO + 2 NC 230 V AC	⊕ C	3SE5 112-3QV10	1	1 unit	102	0.370
	With M12 connector socket, 5-pole (125 V, 4 A) and 2 LEDs							
	Slow-action contacts	1 NO + 1 NC 24 V DC	⊕ C	3SE5 114-1RV10-1AF3	1	1 unit	102	0.360
	With connector socket, 6-pole + PE (10 A) and 2 LEDs							
	Slow-action contacts	1 NO + 1 NC 24 V DC	⊕ C	3SE5 115-1RV10-1AF2	1	1 unit	102	0.380

Enclosure width 56 mm

	5 directions of approach							
	Slow-action contacts	1 NO + 2 NC --	⊕ ▶	3SE5 122-0QV10	1	1 unit	102	0.360
	With increased minimum pull-out force 30 N							
	Slow-action contacts	1 NO + 2 NC --	⊕ B	3SE5 122-0QV10-1AA7	1	1 unit	102	0.360
	With 2 LEDs, yellow/green							
	Slow-action contacts	1 NO + 2 NC 24 V DC	⊕ ▶	3SE5 122-1QV10	1	1 unit	102	0.370
	Slow-action contacts	1 NO + 2 NC 230 V AC	⊕ C	3SE5 122-3QV10	1	1 unit	102	0.370

⊕ Positive opening according to IEC 60947-5-1, Appendix K.

1) Supplied without actuator. Please order separately (see page 13/86).

For 1/2" NPT adaptors and cable glands, see page 13/48.

Limit Switches

SIRIUS 3SE5 Interlock Switches

3SE5, metal and plastic enclosures Accessories

Selection and ordering data

Version	DT	Order No.	List Price \$ per PU	PU (UNIT, SET, M)	PS*	PG	Weight per PU approx. kg
Actuators for 3SE5							
 3SE5 000-0AV01	Standard actuators, length 75.6 mm	A	3SE5 000-0AV01		1	1 unit	102 0.040
 3SE5 000-0AV02	With vertical fixing, length 53 mm	▶	3SE5 000-0AV02		1	1 unit	102 0.070
 3SE5 000-0AV03	With transverse fixing, length 47 mm	▶	3SE5 000-0AV03		1	1 unit	102 0.070
 3SE5 000-0AV06	Radius actuators, length 51 mm • Direction of approach from the left • Direction of approach from the right	▶ A	3SE5 000-0AV04 3SE5 000-0AV06		1 1	1 unit 1 unit	102 0.070 102 0.070
 3SE5 000-0AV05	Universal radius actuators, length 77 mm	▶	3SE5 000-0AV05		1	1 unit	102 0.090
 3SE5 000-0AV07	Universal radius actuators, heavy-duty • Length 67 mm • Length 77 mm	A A	3SE5 000-0AV07-1AK2 3SE5 000-0AV07		1 1	1 unit 1 unit	102 0.120 102 0.090
Optional accessories for 3SE5							
 3SE5 000-0AV08-1AA2	Protective caps made of black rubber for the actuator head, to protect the actuator openings from contamination Not to be used for 3SE5 2.. plastic enclosures.	B	3SE5 000-0AV08-1AA2		1	1 unit	102 0.010
 3SE5 000-0AV08-1AA3	Blocking inserts , high-grade steel, for actuator head, for up to 8 padlocks	B	3SE5 000-0AV08-1AA3		1	1 unit	102 0.065
Connections for 3SE5, 3SE2							
 3SY3 127	Connector sockets (4-pole), M12, fixed for M20 x 1.5 For max. 250 V, 4 A With 0.25 mm ² connecting cable, plastic, degree of protection IP67, ambient temperature -40 to +85 °C	B	3SY3 127		1	1 unit	102 0.010
 3RX8 000	Cable boxes (4-pole), M12 With terminal compartment, can be pre-assembled	A	3RX8 000-0CB45		1	1 unit	574 0.015
	Angular cable boxes (4-pole), M12 With terminal compartment, can be pre-assembled	A	3RX8 000-0CC45		1	1 unit	574 0.015
 3SX9 926	Connector sockets (5-pole), M12, fixed for M20 x 1.5 For max. 125 V, 4 A With 0.25 mm ² connecting cable, plastic, degree of protection IP67, ambient temperature -40 to +85 °C	B	3SY3 128		1	1 unit	102 0.010
	Cable boxes (5-pole), M12 With terminal compart., can be pre-assembled	A	3RX8 000-0CB55		1	1 unit	574 0.016
	Angular cable boxes (5-pole), M12 With terminal compart., can be pre-assembled	A	3RX8 000-0CC55		1	1 unit	574 0.016
	Cable glands M20 x 1.5 Plastic	A	3SX9 926		1	1 unit	102 0.010

Selection and ordering data

1 contact · 3 contacts · Moving double-break contacts ¹⁾²⁾

Actuation	Enclosure width	Length of actuator	DT	3SE. position switches with 3 slow-action contacts	3SE. position switches with 1 slow-action contact	Wght. approx.
				<p>Ident. No. 12 acc. to EN 50 013</p>	<p>Ident. No. 01 acc. to EN 50 013</p>	
				Order No.	List Price \$ 1 unit	kg

Molded plastic enclosure IP 67

3SE2 243-0XX

Top and side entry¹⁾



M20 x 1.5 connecting thread

- Extraction force 5 N 52
- Extraction force 30 N 52
- With automatic ejection 52

M16 x 1.5 connecting thread

- Extraction force 5 N 52
- Extraction force 30 N 52
- With automatic ejection 52

Actuators



- Standard actuator ($r_{min.} = 150$ mm) 28



- Radius actuator (universal) ($r_{min.} = 45$ mm) 33



- Ball catch (up to 100 N) 28



- Actuator with dust protector and slit cover (1 set) 34

- Radius actuator 82

Accessories

- Slit cover only for 3SX3234 (1 set = 3 units)

→ 3SE2 243-0XX40	0.140	→ 3SE2 257-6XX40	0.120
→ 3SE2 243-0XX	0.140	→ 3SE2 257-6XX	0.120
→ 3SE2 243-0XX30	0.140	→ 3SE2 257-6XX30	0.120
→ 3SE2 243-0XX48	0.140	→ 3SE2 257-6XX48	0.140
→ 3SE2 243-0XX18	0.140	→ 3SE2 257-6XX18	0.140
→ 3SE2 243-0XX38	0.140	→ 3SE2 257-6XX38	0.140

3SX3 218	0.020
3SX3 228	0.025
3SX3 217	0.035
3SX3 234	0.035
3SX3 256	0.020
3SX3 233	0.005

For operation, operating speed and travel, see Page 13/92.

→ Positive opening acc. to IEC 60 947-5-1, Appendix K, and DIN VDE 0660 Part 200.

1) Supplied without actuator.

2) For conduit thread adaptors, see page 13/48.

Limit Switches

SIRIUS 3SE5 Interlock Switches

Technical data

Benefits

The 3SE5 position switches with separate actuator differ from the previous series through the following new characteristics:

- All enclosure sizes with increased corrosion protection
- All enclosure sizes are optionally available with a LED signaling indicator.
- The three-pole contact block 1 NO + 2 NC is available for all enclosure sizes.
- The plastic enclosure has simple and fast wiring equipment which makes it possible to save from approx. 20 to 25 % of the time when connecting.
- The ASIsafe electric component is integrated for the versions with the AS-Interface connection ([see online](#)); an adapter is not required.

Application

Position switches with separate actuator are used where the position of doors, covers or protective grills must be monitored for safety reasons.

The position switch can only be operated with the matching coded actuator. Simple overruling by hand or auxiliary devices is impossible.

Devices are available with enclosure versions to suit the particular ambient conditions. Different control tasks can be performed with the best contact blocks suited for the particular purpose. Dimensions, fixing points of the enclosure are in

accordance with EN 50041 or EN 50047 standards. The devices are suitable for use in any climate.

Standards

IEC 60947-5-1 or EN 60947-5-1.

The protective measure of "total insulation" by the molded-plastic enclosure is guaranteed by the use of molded-plastic screw-lands.

Safety position switches

For controls according to IEC 60204-1 or EN 60204-1 the devices can be used as a safety position switch. To secure position switches against changes in their position, keyed techniques must be employed on installation.

Safety circuits

IEC 60947-5-1 and EN 60947-5-1 require positive opening of the NC contacts, i.e. for the purposes of personal safety, the assured opening of NC contacts is expressly stipulated for the electrical equipment of machines in all safety circuits and marked according to the IEC standard 60947-5-1 with the symbol .

Category 3 according to ISO 13849-1 (EN 954-1) can be attained with a position switch with a separate actuator if the corresponding failsafe evaluation units are selected and correctly installed, e.g. the 3TK28 safety relays or matching units from the ASIsafe, SIMATIC or SINUMERIK product ranges.

Category 4 can be achieved when using an additional position switch.

Technical specifications

Type		3SE5 1...-V.., 3SE5 2...-V..	3SE2 257-XX..	3SE2 243-XX..			
General data							
Standards		IEC 60947-5-1, EN 60947-5-1					
Rated insulation voltage U_i	V	400	500				
Pollution degree acc. to IEC 60664-1		Class 3	Class 3				
Rated impulse withstand voltage U_{imp}	kV	6					
Rated operational voltage U_e	V	400 AC; over 300 V AC only equal potential	500 AC; over 380 V AC only equal potential				
Conventional thermal current I_{th}	A	6	10				
Rated operational current I_e		2-pole	3-pole	1-pole	3-pole		
• With alternating current 50/60 Hz		$I_e/AC-15$	$I_e/AC-15$	$I_e/AC-12$	$I_e/AC-15$	$I_e/AC-12$	$I_e/AC-15$
- At 24 V	A	6	6	10	10	10	10
- At 120 V	A	6	3	10	10	10	10
- At 240 V	A	3	1.5	10	6	10	4
- At 400 V	A	—	—	10	4	10	4
- At 500 V	A	—	—	10	3	10	3
• For direct current		$I_e/DC-13$	$I_e/DC-13$	$I_e/DC-12$	$I_e/DC-13$	$I_e/DC-12$	$I_e/DC-13$
- At 24 V	A	3	3	10	10	10	10
- At 125 V	A	0.55	0.55	—	—	—	—
- At 250 V	A	0.27	0.27	—	—	—	—
- At 110 V	A	—	—	4	1	4	1
- At 220 V	A	—	—	1	0.4	1	0.4
- At 440 V	A	—	—	0.5	0.2	0.5	0.2
Short-circuit protection¹⁾							
• With DIAZED fuse links, gG operational class	A	6	6				
• With fuse links, quick		—	10				
• With miniature circuit breaker, Char. C	A	1	2	—			
Mechanical endurance		1 × 10 ⁶ operating cycles					
Electrical endurance							
• With 3RH.1, 3RT contactors in size S00, S0		10 × 10 ⁶ operating cycles		> 1 × 10 ⁶ operating cycles			
• For utilization category AC-15 when switching off $I_e/AC-15$ at 240 V		0.1 × 10 ⁶ operating cycles		0.5 × 10 ⁶ operating cycles			
Switching frequency		6000 operating cycles/h					
With 3RH.1, 3RT contactors in size S00, S0							
Minimum pull-out force for positive opening	N	20	10		30		

Configuration

Operation and operating travel of actuators

Operation by a separate actuator  Positive opening acc. to EN 60947-5-1 v_{max} Max. actuating speed  Direction of operation	Contact blocks Terminal designation acc. to EN 50013	Nominal travel  Contact closed  Contact open Actuator in actuator head: NC is closed
--	--	--

Separate actuators

Standard actuators

Axial and lateral actuation ($4 \times 90^\circ$)

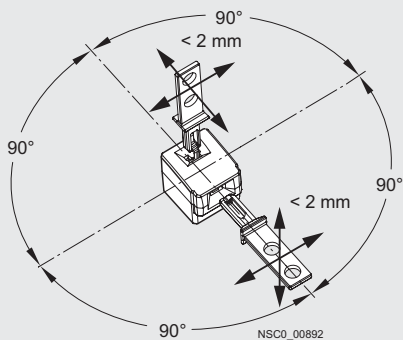

Minimum force required in operating direction 30 N (on retraction)

Slow-action contacts

1 NO + 1 NC

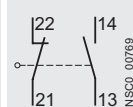

Ident. No. 11

Lateral actuation

3SE5 ...-RV..

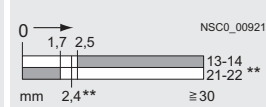

Axial actuation

3SE5 ...-RV..

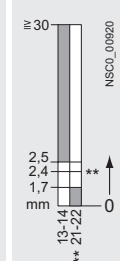

1 NO + 2 NC

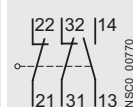

Ident. No. 12

3SE5 ...-QV..

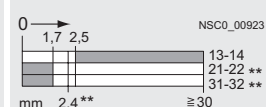

3SE5 ...-QV..

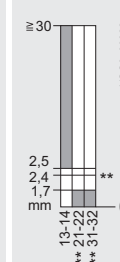

Radius actuators (all directions of approach)

Example: direction of approach from the left

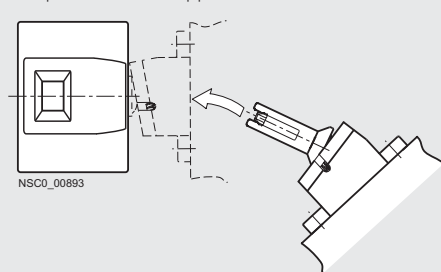

For connector assignment, see page 13/61.

Limit Switches

SIRIUS 3SE5 Interlock Switches

3SE5 with separate actuator
Metal and plastic enclosures

Dimensional drawings

Complete units

Enclosure width 31 mm
3SE5 23.-.QV40, 3SE5 23.-.RV40

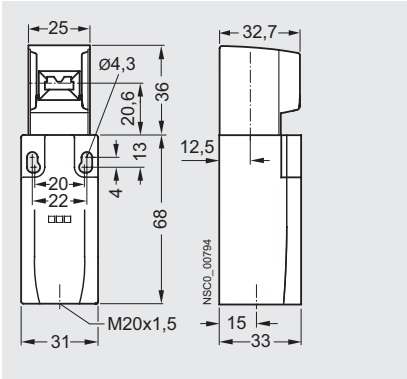

Enclosure width 50 mm
3SE5 24.-.QV40, 3SE5 24.-.RV40

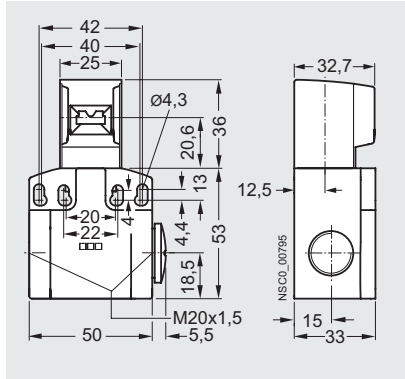

Enclosure width 40 mm
3SE5 11.-.QV10, 3SE5 11.-.RV10

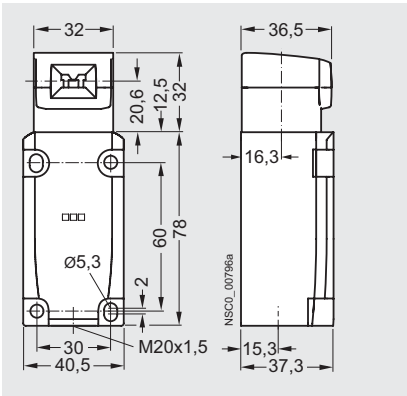

Enclosure width 56 mm
3SE5 12.-.QV10, 3SE5 12.-.RV10

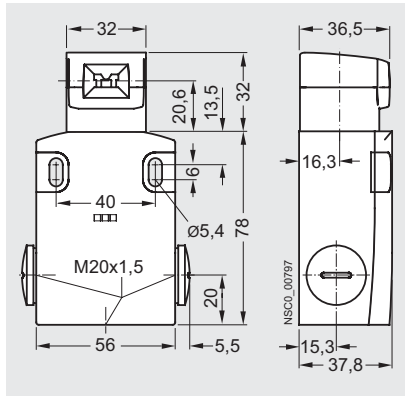

Actuators

3SE5 000-0AV01
standard actuator

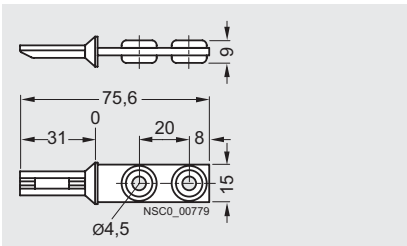

3SE5 000-0AV02
actuator with vertical fixing

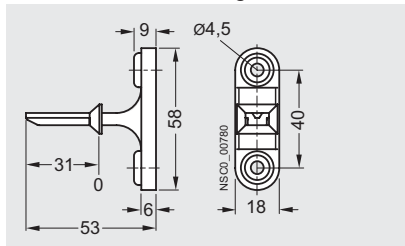

3SE5 000-0AV03
actuator with horizontal fixing

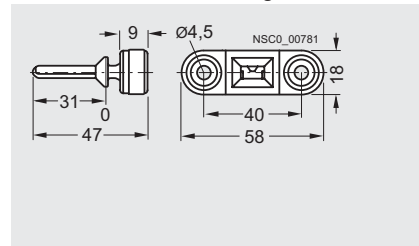

3SE5 000-0AV04
radius actuator, approach from left

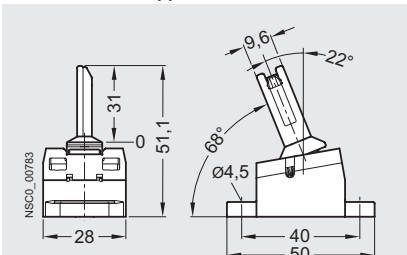

3SE5 000-0AV06
radius actuator approach from right

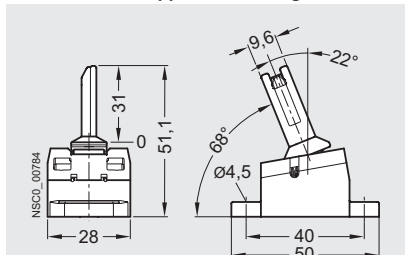

3SE5 000-0AV05
universal radius actuator

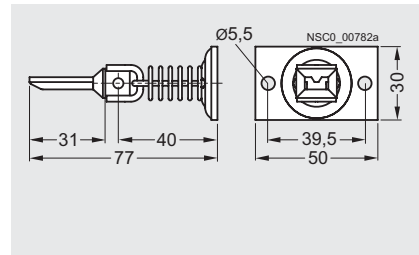

Mechanical Safety

SIRIUS 3SE5 Interlock Switches

3SE5 with separate actuator
Metal and plastic enclosures

1

2

3

4

5

6

7

8

9

10

11

12

13

3SE5 000-0AV07
universal radius actuator, heavy duty

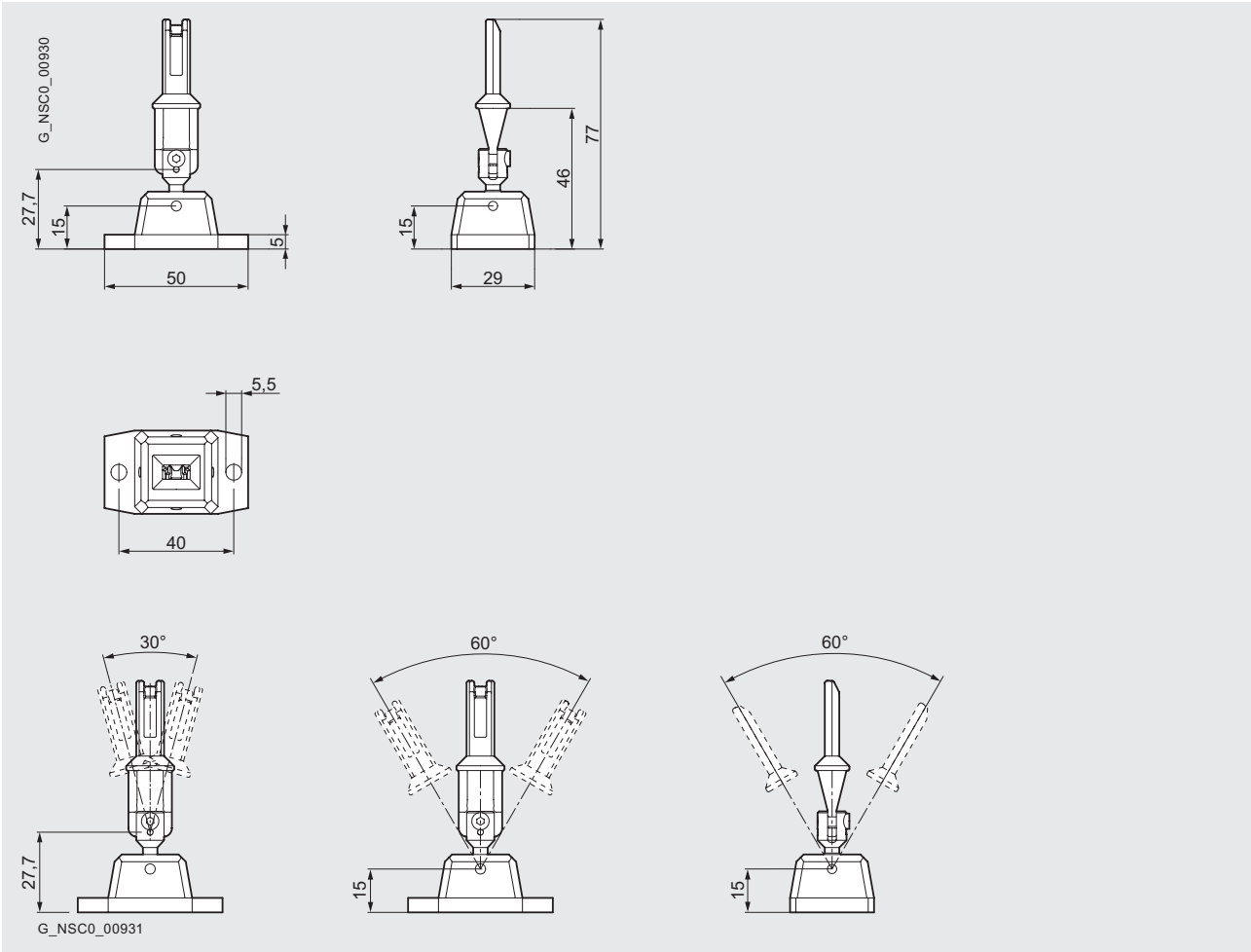



Limit Switches

SIRIUS 3SE5 Interlock Switches

3SE2 with separate actuator
Plastic enclosures

Configuration

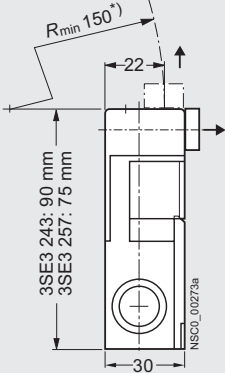
Operation and operating travel of actuators

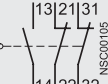
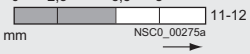
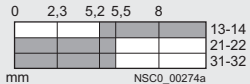
Operation by a separate actuator v_{max} Max. actuating speed \rightarrow Direction of operation Radius actuation: for all directions of approach	Contact blocks Terminal designation acc. to EN 50013	Nominal travel  Actuator in actuator head: NC is closed	Minimum force required in operating direction on retraction
Separate actuators			
Standard and radius actuators			
Axial and lateral actuation  <p>*) Radius actuator: $R_{min} > 38$ mm.</p>	Slow-action contacts 1 NC  Ident. No. 01 1 NO + 2 NC  Ident. No. 12	Lateral actuation 3SE2 257-XX..  3SE2 243-XX.. 	30 N or 5 N 30 N or 5 N

Dimensional drawings

3SE2 243, lateral and front-end actuation, with 3SX3 218 standard actuator

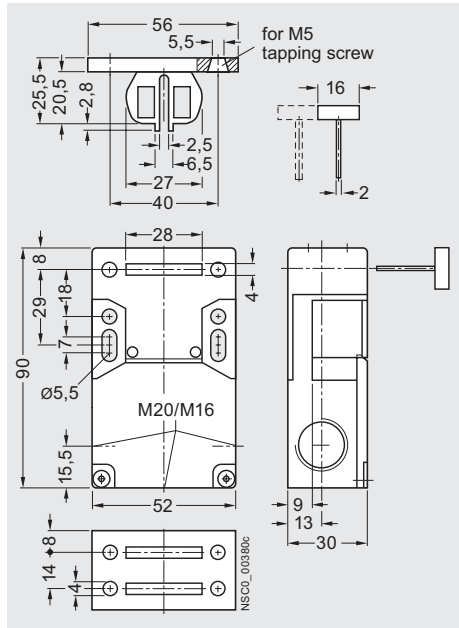

3SE2 257, lateral and front-end actuation

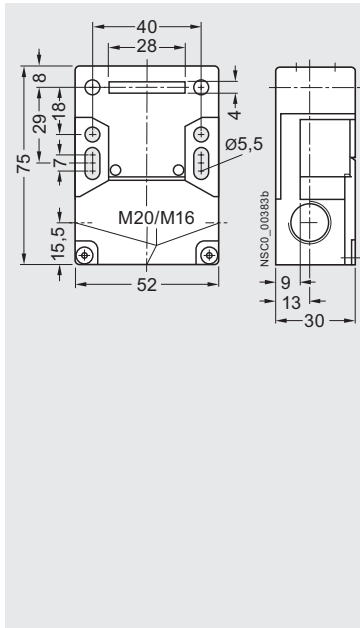

3SX3 228 universal radius actuator

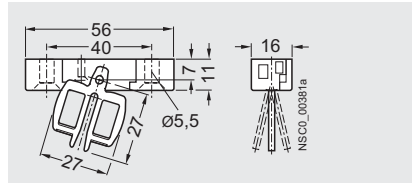

3SX3 217 actuator with ball locating

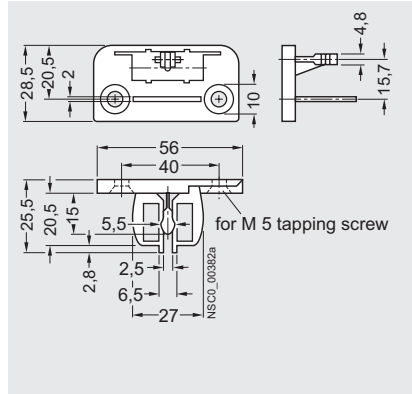

Overview

The position switches with solenoid interlocking are exceptional, technically safe devices which restrict and prevent an unforeseen or intentional opening of protective doors, protective grilles or other covers as long as a dangerous situation is present (i. e. follow-on motion of the shutdown machine).



The safety position switches with solenoid interlocking are comprised of a switch part with electromechanical interlock and a mechanical actuator which has to be ordered separately.

They are rugged protective devices that enable the greatest possible safety for man and machine.

The position switches with solenoid interlocking are offered in plastic or metal enclosures.

Dimensions (W × H × D):

- 3SE5 3: 54 mm × 185 mm × 43.5 mm,
- 3SE2 8: 90 mm × 100 mm (+ head 41.3 mm) × 45 mm.

Operation

The actuator head is included in the scope of supply. For actuation from four directions it can be adjusted through 4 × 90°. The 3SE5 3 switches can also be approached from above.

The actuators are not included in the scope of supply of the position switch and must be ordered separately from a choice of six versions to suit the application (see page 13/97).

Actuation data:

- Maximum actuating speed $v_{\max} = 1.5 \text{ m/s}$
- Minimum actuating speed $v_{\min} = 0.4 \text{ mm/s}$
- Minimum force in the direction of actuation $F_{\min} = 30 \text{ N}$

The actuator is encoded. Simple overruling by hand or auxiliary devices is impossible.

Radius actuators

The position switches with radius actuators are particularly suitable for rotatable protective devices. The movable actuation key allows even small radii to be approached. Damage to the switch and the actuator due to inaccurate approach is prevented.

Locking devices

A high-grade steel locking device for attaching up to eight padlocks is available for even more safety (see page 13/97).

Dust protection

A rubber cap to protect the actuator head from contamination is available for operation in dusty environments (see page 13/97).

Solenoid interlocking

There are two versions for locking the actuator:

- Spring-actuated lock (closed-circuit principle) with various release mechanisms
- Magnetic field lock (open-circuit principle)

The spring-actuated switch is equipped with an auxiliary release for emergency situations or setup mode. Available as options:

- Escape release or
- Emergency release

Contact blocks

The position switches with solenoid interlocking have one contact block each for:





- Monitoring the actuator or the position of the protective door
- Monitoring the position of the solenoid

The mechanical design of the switch corresponds to the requirements of the failsafe principle according to EN 1088.

Optical signaling equipment

The position switches with solenoid interlocking are available with an optional optical signaling device.

The signaling device indicates the switch position of the lock and the protective device optically by means of 2 LEDs on the front.

Protective device	Interlock	Display	Meaning
Closed	Released	 ¹⁾  ²⁾	Actuator free to be pulled
Closed	Closed	 ²⁾	Actuator locked
Open	Open	 ¹⁾	Actuator pulled

Note:

The voltage of the LEDs at the monitored contacts must be the same as the operational voltage of the solenoid (same potential).

¹⁾ Yellow LED.

²⁾ Green LED.

Limit Switches

SIRIUS 3SE5 Interlock Switches

3SE5 / 3SE2 with solenoid locking General data

Benefits

The new generation of 3SE5 3 position switches offers:

- More safety through higher locking forces:
 - 1300 N with plastic enclosure
 - 2600 N with metal enclosure
- Various release mechanisms: lock release, escape release and emergency release
- Two contact blocks each with three contacts as standard equipment, hence fewer versions needed
- Same dimensions for all enclosure variants: Plastic, metal or with integrated ASIsafe
- An extensive range of actuators
- An optional LED status display 24 V DC, 115 V AC or 230 V AC for all switch variants

Application

The position switches with solenoid interlocking are exceptional, technically safe devices which restrict and prevent an unforeseen or intentional opening of protective doors, protective grilles or other covers as long as a dangerous situation is present (i.e. follow-on motion of the shutdown machine).

The safety position switches with solenoid interlocking have the following functions:

- Enabling the machine or process with closed and locked protective device
- Locking the machine or process with opened protective device
- Position monitoring of the protective device and solenoid

Standards

The switches comply with the standards IEC 60947-1 (Low-Voltage Controlgear, General) and IEC 60947-5-1 (Electromechanical Control Devices).

The mechanical design of the switch corresponds to the requirements of the failsafe principle according to EN 1088.

Approvals

The switches are approved for use with locking devices according to EN 1088 and EN 292, Parts 1 and 2.

3SE5 3 position switches with solenoid interlocking bear the VDE test mark for tested according to GS-ET 19 (Test Principles of the German Trade Association for Locking Devices with Electromagnetic Interlocks).

The 3SE2 8 metal-enclosed position switches with solenoid interlocking have been awarded a test certificate from the BIA (Berufsgenossenschaftliches Institut für Arbeitssicherheit).

Category 3 according to ISO 13849-1 (EN 954-1) can be attained with a position switch with solenoid interlocking if the corresponding failsafe evaluation units are selected and correctly installed, e. g. the 3TK28 safety relays or matching units from the ASIsafe, SIMATIC or SINUMERIK product ranges.

Category 4 can be achieved when using an additional position switch.

They are approved according to UL 508, UL 50 and UL 746-C.

Solenoid interlocking

The separate actuator operates in a similar way to the coding of a key and protects against manipulation. It transmits the locking force to the protective device and helps to monitor its position.

There are two versions of locking:

Spring-actuated lock (closed-circuit principle)

- In the standard version, the position switch locks by means of spring force and releases by means of electromagnetic force. In the case of voltage failure, it reliably prevents the protective device from opening when machine parts are still moving.
- The switch is equipped with an auxiliary release for emergency situations or setup mode.
- An auxiliary release which can be secured with a lock to prevent misuse is available as a version.



Auxiliary release

Auxiliary release with lock

The new 3SE5 3 position switches are also available with an escape release or an emergency release.

- Personnel working inside the hazard zone can use the escape release feature to manually release the interlock without tools from the escape side (hazardous area side) so that they can exit the hazard area. An intentional act (in this case pulling the gray actuator) is required to release the locking mechanism and restore the normal operating state.
- The emergency release enables someone in an emergency situation to manually release the interlock without tools from the access side (outside the hazardous area). Releasing the lock and restoring the normal operating state must require effort which is comparable to repair activity, in this case disassembly of the red actuator and resetting the mechanical lock.

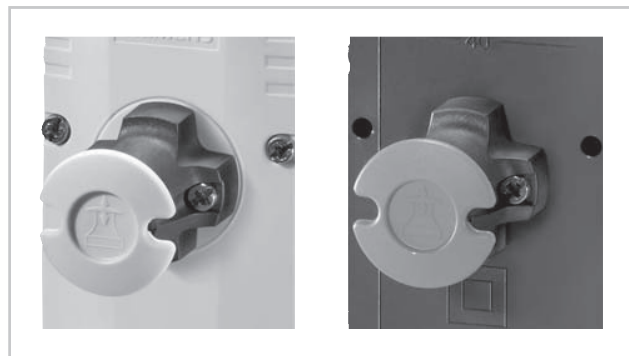

Escape release from the front

Emergency release from the back

Magnetic field lock (open-circuit principle)

- The second version offers locking by means of electromagnetic force and release by means of spring force. This version has an advantage when it is necessary to quickly access the machine after a power failure occurs, or in the case of very short overtravel times.

Mechanical Safety

SIRIUS 3SE5 Interlock Switches

3SE5, plastic enclosures
with locking force up to 1200 N







1
2
3
4
5
6
7
8
9
10
11
12
13

Selection and ordering data

6 slow-action contacts · 5 directions of approach · Cable entry 3 × M20 × 1.5 · Degree of protection IP66/IP67
Locking force 1300 N (1000 N according to GS-ET 19)

Interlock ¹⁾	LEDs	Solenoid Rated opera- tional voltage	DT	Complete units Position monitoring: Actuators: 1 NO + 2 NC Solenoid: 1 NO + 2 NC	<input type="checkbox"/>	PU (UNIT, SET, M)	PS*	PG	Weight per PU approx.
		V		Order No.	Price \$ per PU				kg

1300 N locking force · Enclosure width 54 mm

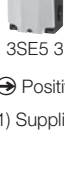
		LEDs	Solenoid Rated opera- tional voltage	DT	Complete units Position monitoring: Actuators: 1 NO + 2 NC Solenoid: 1 NO + 2 NC	<input type="checkbox"/>	PU (UNIT, SET, M)	PS*	PG	Weight per PU approx.
Spring-actuated locks										
	• With auxiliary release	--	24 DC	⊕ A	3SE5 322-0SD21		1	1 unit	102	0.590
		--	115 AC	⊕ B	3SE5 322-0SD22		1	1 unit	102	0.590
		--	230 AC	⊕ B	3SE5 322-0SD23		1	1 unit	102	0.590
		Yellow/Green	24 DC	⊕ A	3SE5 322-1SD21		1	1 unit	102	0.590
		Yellow/Green	115 AC	⊕ B	3SE5 322-2SD22		1	1 unit	102	0.590
		Yellow/Green	230 AC	⊕ B	3SE5 322-3SD23		1	1 unit	102	0.590
	• With auxiliary release	--	24 DC	⊕ ▶	3SE5 322-0SE21		1	1 unit	102	0.745
	With lock	--	115 AC	⊕ B	3SE5 322-0SE22		1	1 unit	102	0.745
		--	230 AC	⊕ B	3SE5 322-0SE23		1	1 unit	102	0.745
		Yellow/Green	24 DC	⊕ B	3SE5 322-1SE21		1	1 unit	102	0.745
		Yellow/Green	115 AC	⊕ B	3SE5 322-2SE22		1	1 unit	102	0.745
		Yellow/Green	230 AC	⊕ B	3SE5 322-3SE23		1	1 unit	102	0.745
	• With escape release	--	24 DC	⊕ B	3SE5 322-0SF21		1	1 unit	102	0.590
	from the front	--	115 AC	⊕ B	3SE5 322-0SF22		1	1 unit	102	0.590
		--	230 AC	⊕ B	3SE5 322-0SF23		1	1 unit	102	0.590
		Yellow/Green	24 DC	⊕ B	3SE5 322-1SF21		1	1 unit	102	0.590
		Yellow/Green	115 AC	⊕ B	3SE5 322-2SF22		1	1 unit	102	0.590
		Yellow/Green	230 AC	⊕ B	3SE5 322-3SF23		1	1 unit	102	0.590
	• With escape release	--	24 DC	⊕ B	3SE5 322-0SL21		1	1 unit	102	0.590
	from the front and									
	emergency release from back									
	• For ambient temperature	--	24 DC	⊕ B	3SE5 322-0SL21-1AJ0		1	1 unit	102	0.590
	up to to -40 °C									
	• With escape release	--	24 DC	⊕ B	3SE5 322-0SG21		1	1 unit	102	0.590
	from the back	--	115 AC	⊕ B	3SE5 322-0SG22		1	1 unit	102	0.590
	and auxiliary release	--	230 AC	⊕ B	3SE5 322-0SG23		1	1 unit	102	0.590
	from the front	Yellow/Green	24 DC	⊕ ▶	3SE5 322-1SG21		1	1 unit	102	0.590
		Yellow/Green	115 AC	⊕ B	3SE5 322-2SG22		1	1 unit	102	0.590
		Yellow/Green	230 AC	⊕ B	3SE5 322-3SG23		1	1 unit	102	0.590
	• With escape release	--	24 DC	⊕ B	3SE5 322-0SH21		1	1 unit	102	0.745
	from the back									
	and auxiliary release									
	with lock from the front									
	• With emergency release	--	24 DC	⊕ B	3SE5 322-0SJ21		1	1 unit	102	0.745
	from the back	--	115 AC	⊕ B	3SE5 322-0SJ22		1	1 unit	102	0.745
and auxiliary release	--	230 AC	⊕ B	3SE5 322-0SJ23		1	1 unit	102	0.745	
from the front	Yellow/Green	24 DC	⊕ B	3SE5 322-1SJ21		1	1 unit	102	0.745	
	Yellow/Green	115 AC	⊕ B	3SE5 322-2SJ22		1	1 unit	102	0.745	
	Yellow/Green	230 AC	⊕ B	3SE5 322-3SJ23		1	1 unit	102	0.745	
	Magnetic field locks	--	24 DC	⊕ ▶	3SE5 322-0SB21		1	1 unit	102	0.590
		--	115 AC	⊕ B	3SE5 322-0SB22		1	1 unit	102	0.590
		--	230 AC	⊕ B	3SE5 322-0SB23		1	1 unit	102	0.590
		Yellow/Green	24 DC	⊕ A	3SE5 322-1SB21		1	1 unit	102	0.590
		Yellow/Green	115 AC	⊕ B	3SE5 322-2SB22		1	1 unit	102	0.590
		Yellow/Green	230 AC	⊕ B	3SE5 322-3SB23		1	1 unit	102	0.590

⊕ Positive opening according to IEC 60947-1, Appendix K.

1) Supplied without actuator. Please order separately (see page 13/97).

For 1/2" NPT adaptors and cable glands, see page 13/48.

Limit Switches

SIRIUS 3SE5 Interlock Switches







**3SE5, metal enclosures
with locking force up to 2000 N**

Selection and ordering data

6 slow-action contacts · 5 directions of approach · Cable entry 3 × M20 × 1.5 · Degree of protection IP66/IP67
Locking force 2600 N (2000 N according to GS-ET 19)

Interlock ¹⁾	LEDs	Solenoid Rated opera- tional voltage	DT	Complete units Position monitoring: Actuators: 1 NO + 2 NC Solenoid: 1 NO + 2 NC	<input type="checkbox"/>	PU (UNIT, SET, M)	PS*	PG	Weight per PU approx.
		V		Order No.	Price \$ per PU				kg

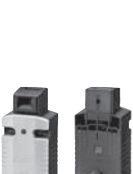
2600 N locking force · Enclosure width 54 mm

Spring-actuated locks												
	• With auxiliary release	--	24 DC	⊕ ▶	3SE5 312-0SD11		1	1 unit	102	1.030		
		--	115 AC	⊕ ▶	3SE5 312-0SD12		1	1 unit	102	1.030		
		--	230 AC	⊕ B	3SE5 312-0SD13		1	1 unit	102	1.030		
		Yellow/Green	24 DC	⊕ B	3SE5 312-1SD11		1	1 unit	102	1.040		
		Yellow/Green	115 AC	⊕ ▶	3SE5 312-2SD12		1	1 unit	102	1.040		
		Yellow/Green	230 AC	⊕ B	3SE5 312-3SD13		1	1 unit	102	1.040		
	• With auxiliary release With lock	--	24 DC	⊕ B	3SE5 312-0SE11		1	1 unit	102	1.180		
		--	115 AC	⊕ B	3SE5 312-0SE12		1	1 unit	102	1.180		
		--	230 AC	⊕ B	3SE5 312-0SE13		1	1 unit	102	1.180		
			48 AC/DC	⊕ C	3SE5 312-0SE14		1	1 unit	102	1.180		
		Yellow/Green	24 DC	⊕ B	3SE5 312-1SE11		1	1 unit	102	1.180		
		Yellow/Green	115 AC	⊕ B	3SE5 312-2SE12		1	1 unit	102	1.180		
	• With escape release from the front	--	24 DC	⊕ B	3SE5 312-0SF11		1	1 unit	102	1.180		
		--	115 AC	⊕ B	3SE5 312-0SF12		1	1 unit	102	1.180		
		--	230 AC	⊕ B	3SE5 312-0SF13		1	1 unit	102	1.180		
		Yellow/Green	24 DC	⊕ B	3SE5 312-1SF11		1	1 unit	102	1.180		
		Yellow/Green	115 AC	⊕ B	3SE5 312-2SF12		1	1 unit	102	1.180		
		Yellow/Green	230 AC	⊕ B	3SE5 312-3SF13		1	1 unit	102	1.180		
	• With escape release from the back and auxiliary release from the front	--	24 DC	⊕ B	3SE5 312-0SG11		1	1 unit	102	1.175		
		--	115 AC	⊕ B	3SE5 312-0SG12		1	1 unit	102	1.175		
		--	230 AC	⊕ B	3SE5 312-0SG13		1	1 unit	102	1.175		
		Yellow/Green	24 DC	⊕ ▶	3SE5 312-1SG11		1	1 unit	102	1.180		
		Yellow/Green	115 AC	⊕ B	3SE5 312-2SG12		1	1 unit	102	1.180		
		Yellow/Green	230 AC	⊕ B	3SE5 312-3SG13		1	1 unit	102	1.180		
	• With escape release from the back and auxiliary release with lock from the front	--	24 DC	⊕ B	3SE5 312-0SH11		1	1 unit	102	1.180		
	• With emergency release from the back and auxiliary release from the front	--	24 DC	⊕ B	3SE5 312-0SJ11		1	1 unit	102	1.180		
		--	115 AC	⊕ B	3SE5 312-0SJ12		1	1 unit	102	1.180		
		--	230 AC	⊕ B	3SE5 312-0SJ13		1	1 unit	102	1.180		
		Yellow/Green	24 DC	⊕ B	3SE5 312-1SJ11		1	1 unit	102	1.180		
		Yellow/Green	115 AC	⊕ B	3SE5 312-2SJ12		1	1 unit	102	1.180		
Yellow/Green		230 AC	⊕ B	3SE5 312-3SJ13		1	1 unit	102	1.180			
	Magnetic field locks			--	24 DC	⊕ ▶	3SE5 312-0SB11		1	1 unit	102	1.030
		--	115 AC	⊕ B	3SE5 312-0SB12		1	1 unit	102	1.030		
		--	230 AC	⊕ B	3SE5 312-0SB13		1	1 unit	102	1.030		
		Yellow/Green	24 DC	⊕ B	3SE5 312-1SB11		1	1 unit	102	1.040		
		Yellow/Green	115 AC	⊕ B	3SE5 312-2SB12		1	1 unit	102	1.040		
		Yellow/Green	230 AC	⊕ B	3SE5 312-3SB13		1	1 unit	102	1.040		

⊕ Positive opening according to IEC 60947-5-1, Appendix K.

1) Supplied without actuator. Please order separately (see page 13/97).

For 1/2" NPT adaptors and cable glands, see page 13/48.

Mechanical Safety

SIRIUS 3SE5 Interlock Switches

3SE5, metal and plastic enclosures
Accessories

1

2

3

4

5

6

7

8

9

10

11

12

13

Selection and ordering data

Version	DT	Order No.	List Price \$ per PU	PU (UNIT, SET, M)	PS*	PG	Weight per PU approx. kg	
Actuators for 3SE5 ¹⁾								
 3SE5 000-0AV01		Standard actuators, length 75.6 mm	A	3SE5 000-0AV01	1	1 unit	102 0.040	
 3SE5 000-0AV02		With vertical fixing, length 53 mm	A	3SE5 000-0AV02	1	1 unit	102 0.070	
 3SE5 000-0AV03		With transverse fixing, length 47 mm	A	3SE5 000-0AV03	1	1 unit	102 0.070	
 3SE5 000-0AV04		Radius actuators, length 51 mm • Direction of approach from the left • Direction of approach from the right	A	3SE5 000-0AV04	1	1 unit	102 0.070	
	A		3SE5 000-0AV06	1	1 unit	102 0.070		
 3SE5 000-0AV05		Universal radius actuators, • Length 77 mm • Length 77 mm, tab rotated 90°	A	3SE5 000-0AV05	1	1 unit	102 0.090	
	A		3SE5 000-0AV05-1AA6	1	1 unit	102 0.090		
 3SE5 000-0AV07		Universal radius actuators, heavy-duty • Length 67 mm • Length 77 mm	A	3SE5 000-0AV07-1AK2	1	1 unit	102 0.120	
	A		3SE5 000-0AV07	1	1 unit	102 0.090		
Optional accessories for 3SE5								
 3SE5 000-0AV08-1AA2		Protective caps made of black rubber for the actuator head, to protect the actuator openings from contamination	B	3SE5 000-0AV08-1AA2	1	1 unit	102 0.010	
 3SE5 000-0AV08-1AA3		Blocking inserts , high-grade steel, for actuator head, for up to 8 padlocks	B	3SE5 000-0AV08-1AA3	1	1 unit	102 0.065	
Connections for 3SE5, 3SE2								
 3SY3 127		Connector sockets (4-pole), M12, fixed for M20 x 1.5 For max. 250 V, 4 A With 0.25 mm ² connecting cable, plastic, degree of protection IP67, ambient temperature -40 to +85 °C	B	3SY3 127	1	1 unit	102 0.010	
	 3RX8 000		Cable boxes (4-pole), M12, non-adjustable With terminal compartment, can be pre-assembled	A	3RX8 000-0CB45	1	1 unit	574 0.015
			Angular cable boxes (4-pole), M12 With terminal compartment, can be pre-assembled	A	3RX8 000-0CC45	1	1 unit	574 0.015
 3SX9 926		Connector sockets (5-pole), M12 for M20 x 1.5 For max. 125 V, 4 A With 0.25 mm ² connecting cable, plastic, degree of protection IP67, ambient temperature -40 to +85 °C	B	3SY3 128	1	1 unit	102 0.010	
		Cable boxes (5-pole), M12 With terminal compartment, can be pre-assembled	A	3RX8 000-0CB55	1	1 unit	574 0.016	
		Angular cable boxes (5-pole), M12 With terminal compartment, can be pre-assembled	A	3RX8 000-0CC55	1	1 unit	574 0.016	
		Cable glands M20 x 1.5 Plastic	A	3SX9 926	1	1 unit	102 0.010	

1) See page 13/90 for dimensions drawings.

Limit Switches

SIRIUS 3SE5 Interlock Switches

3SE5 / 3SE2 with solenoid locking

Technical specifications

Type		3SE5 322	3SE5 312	3SE2 83, 3SE2 84
General data				
Standards		IEC 60947-5-1, EN 60947-5-1		
Rated insulation voltage U_i	V	250		
Degree of pollution acc. to EN 60664-1		Class 3		
Rated impulse withstand voltage U_{imp}	kV	4		6
Rated operational voltage U_e				
• DC	V	24		24
• AC 50/60 Hz	V	230		110 ... 130 230
Conventional thermal current I_{th}	A	6		10
Rated operational current I_e				
• With alternating current 50/60 Hz		I_e /AC-15 or B300		I_e /AC-12 I_e /AC-15
- At 24 V	A	6		10 4
- At 120 V	A	3		10 4
- At 230 V	A	1.5		10 4
• For direct current		I_e /DC-13 or Q300		I_e /DC-12 I_e /DC-13
- At 24 V	A	3		10 3
- At 60 V		--		5 1.5
- At 110 V		--		2.5 0.7
- At 125 V	A	0.55		-- --
- At 220 V		--		1 0.3
- At 250 V	A	0.27		-- --
Magnet				
• Locking force, max.	N	1300	2600	1820
• Locking force acc. to GS-ET 19	N	1000	2000	1400
• Power consumption at U_c	W	3.5		5.2
Short-circuit protection¹⁾				
• With DIAZED fuse links, operational class gG	A	6		6
• Characteristic quick		--		10
• With miniature circuit breaker, Char. C	A	0.5		--
Mechanical endurance		1 × 10 ⁶ operating cycles		1 × 10 ⁶ operating cycles
Electrical endurance				
• With 3RH11, 3RT10 16 to 3RT10 26 contactors		1 × 10 ⁶ operating cycles		1 × 10 ⁶ operating cycles
• For AC-15 utilization category		1 × 10 ⁵ operating cycles, when interrupting I_e /AC-15 at 230 V		0.5 × 10 ⁶ operating cycles, when interrupting I_e /AC-15 at 230 V
• For DC-13 utilization category		With DC current the contact endurance depends not only on the breaking current but also on the voltage, the circuit inductance and the speed of switching. No generally valid information can be given.		
Switching frequency With 3RH11, 3RT10 16 to 3RT10 26 contactors		6 × 10 ³ operating cycles/h		
Shock resistance acc. to IEC 60068-2-27		30 g/11 ms		--

Type		3SE5 322	3SE5 312	3SE2 83, 3SE2 84
Enclosure				
Enclosure material		Ultramid A3X2G7	Zinc diecasting GD Zn Al4 Cu1	Aluminum (GD - AISi 12)
Degree of protection acc. to EN 60529		IP66/IP67		IP67
Ambient temperature				
• During operation	°C	-25 ... +60		-30 ... +70
• During storage, transport	°C	-40 ... +80		--
Mounting position		Any		
Connection				
Cable entry		M 20 × 1.5		M 20 × 1.5
Conductor cross-sections				
• Solid	mm ²	1 × (0.5 ... 1.5)		2 × 2.5
• Finely stranded with end sleeve	mm ²	2 × (0.5 ... 0.75)		2 × 1.5
Protective conductor connection Inside enclosure		--		M3.5

¹⁾ Without any welds according to IEC 60947-5-1.

Schematics

3SE5

Monitoring the actuator:
Slow-action contacts 1 NO + 2 NC

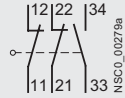

Monitoring the solenoid:
Slow-action contacts 1 NO + 2 NC

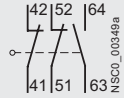

Configuration

Operation and operating travel of actuators

Operation by a separate actuator

- ⊕ Positive opening acc. to EN 60947-5-1
- V_{max} Max. actuating speed
- Direction of operation

Contact blocks

Terminal designation acc. to EN 50013

Nominal travel

- Contact closed
- Contact open
- Actuator in actuator head: NC is closed

Separate actuators with solenoid interlocking

Standard actuators

Axial and lateral actuation ($4 \times 90^\circ$)

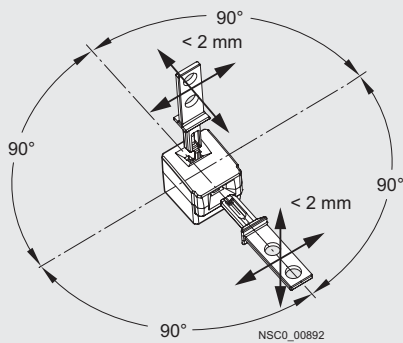

Minimum force required in operating direction 30 N (on retraction)

Radius actuators (all directions of approach)

Example: Direction of approach from the left

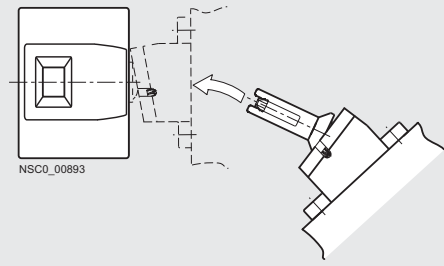

For connector socket assignment, see page 13/61.

Slow-action contacts

1 NO + 2 NC

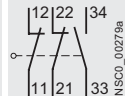

Ident. No. 12

Lateral actuation

3SE5 3...-S...

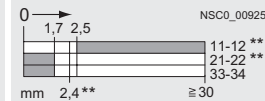

Axial actuation

3SE5 3...-S...

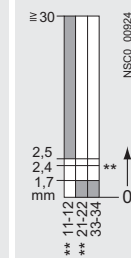

Limit Switches

SIRIUS 3SE5 Interlock Switches

3SE5 with solenoid locking
Metal and plastic enclosures

Dimensional drawings

Spring-actuated lock, with auxiliary release
3SE5 322-SD2., 3SE5 322-SG2., 3SE5 322-SJ2.,
3SE5 312-SD1., 3SE5 312-SG1., 3SE5 312-SJ1.,

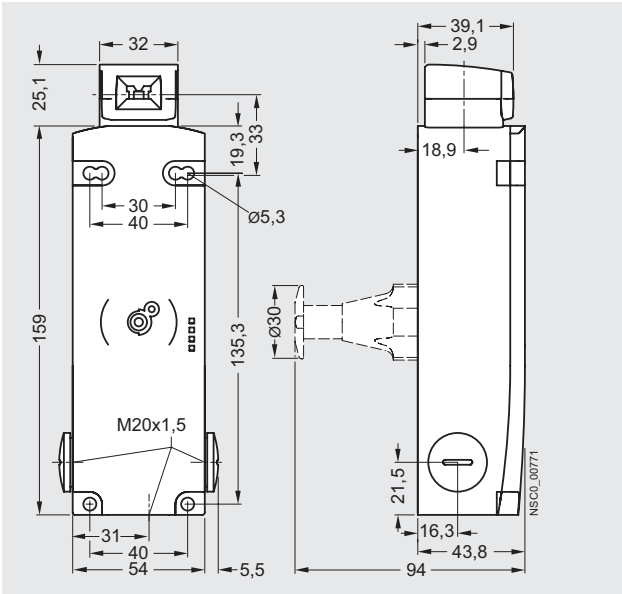

Spring-actuated lock, with auxiliary release with lock
3SE5 322-SE2.,
3SE5 312-SE1.

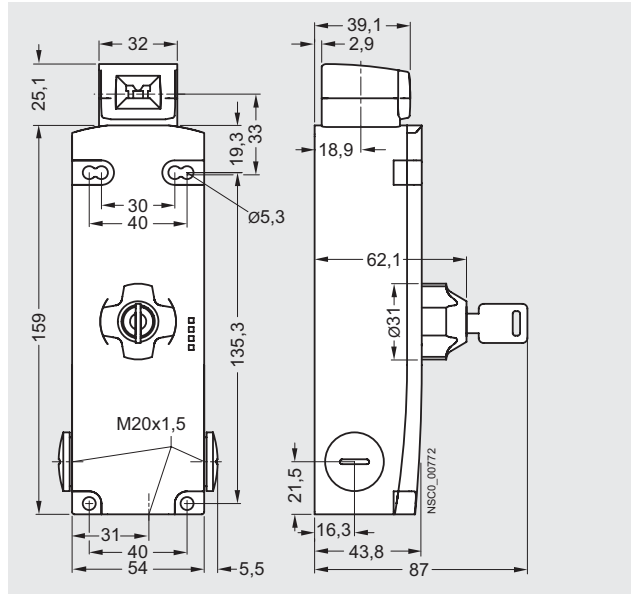

Spring-actuated lock, with escape release
3SE5 322-SF2.,
3SE5 312-SF1.

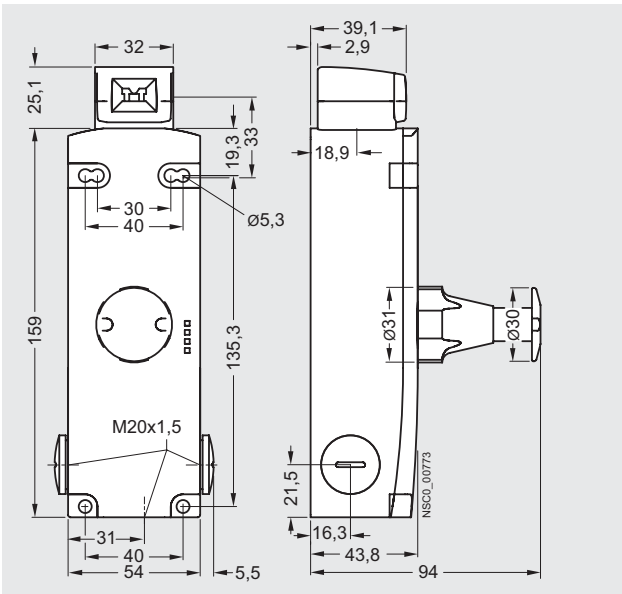

Magnetic field lock
3SE5 322-SB2.,
3SE5 312-SB1.

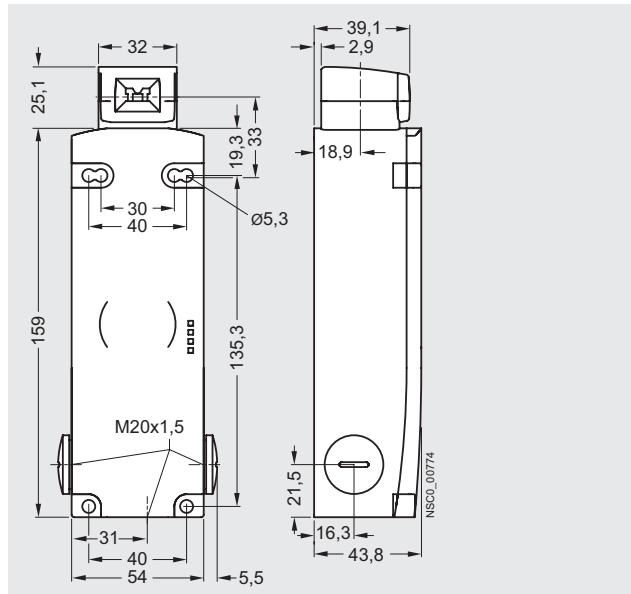

The plastic enclosures have knock-out openings behind the connecting thread; they are delivered therefore without protective caps.

For actuators see page 13/90.

Overview

3SE5 hinge switches have the same enclosures as the standard switches (modular system).



Hinge switches

Design

Enclosure sizes

The 3SE5 switches are available as complete units in two enclosure sizes:

- Plastic enclosures according to EN 50047, 31 mm wide, IP65, 1 cable entry
- Metal enclosures according to EN 50047, 31 mm wide, IP66/IP67, 1 cable entry
- Plastic and metal enclosures according to EN 50041, 40 mm wide, IP66/IP67, 1 cable entry

Enclosure versions

Various basic versions can be selected for the enclosures:

- Available with two or three-pole contact blocks designed as snap-action contacts
- Metal enclosures for explosion protection (ATEX) ([see online](#))
- AS-Interface version with integrated ASIsafe electronics for all enclosure designs ([see online](#))

For a description of the basic switches, [see page 13/6](#).

Operating mechanism

The hinge switches are provided for mounting on hinges. The actuator head is included in the scope of supply. There are two versions:

- Operating mechanism with hollow shaft, inner diameter 8 mm, outer 12 mm
- Operating mechanism with solid shaft, diameter 10 mm

Benefits

The 3SE5 hinge switches differ from the previous series through the following new characteristics:

- All actuators can be turned around the axis in increments of 22.5° ([see picture on page 13/6](#)).
- The new three-pole contact block 1 NO + 2 NC is available for all enclosure sizes ([see picture on page 13/7](#)).
- The plastic enclosure with a width of 31 mm has simple and fast wiring equipment which makes it possible to save from approx. 20 to 25 % of the time when connecting ([see picture on page 13/7](#)).
- The ASIsafe electric component is integrated for the versions with the AS-Interface connection ([see online](#)); an additional adapter is not required.

Application

The hinge switches are used in those areas where the position of swiveling protective devices such as doors or flaps must be monitored. With these switches, the position of the doors and hinge switches is converted into electric signals. The switches allow shutdown and signaling without delay in the event of a small opening angle through the snap-action contacts with an operating angle of 10°.

Devices are available with enclosure versions to suit the particular ambient conditions. Different control tasks can be performed with the best contact blocks suited for the particular purpose. Dimensions and fixing points of the enclosures are in accordance with EN 50041 or EN 50047 standards.

The devices are suitable for use in any climate.

Standards

IEC 60947-5-1 or EN 60947-5-1.

The protective measure of "total insulation" by the molded-plastic enclosure is guaranteed by the use of molded-plastic screw-glands.

Safety position switches

For controls according to IEC 60204-1 or EN 60204-1 the devices can be used as a safety position switch. To secure position switches against changes in their position, keyed techniques must be employed on installation.

Safety circuits

IEC 60947-5-1 and EN 60947-5-1 require positive opening of the NC contacts, i.e. for the purposes of personal safety, the assured opening of NC contacts is expressly stipulated for the electrical equipment of machines in all safety circuits and marked according to IEC 60947-5-1 with the symbol

Category 4 according to EN 954-1 can be attained with the 3SE5 hinge switches with if the corresponding failsafe evaluation units are selected and correctly installed, e.g. the 3TK28 safety relays or matching devices from the ASIsafe, SIMATIC or SINUMERIK product ranges.

Mechanical Safety

SIRIUS 3SE5 Hinge Switches

3SE5, plastic enclosures
Enclosure width 31 mm / 40 mm

Selection and ordering data

Complete units

2 or 3 contacts · Degree of protection IP65 (31 mm) or IP67/IP68 (40 mm) · Cable entry M20 × 1.5

Version	Snap-action contacts	DT	Complete units	<input type="checkbox"/>	PU (UNIT, SET, M)	PS*
			Configurator			
		Order No.	Price per PU			

Plastic enclosures · Enclosure width 31 mm acc. to EN 50047



With hollow shaft

With hollow shaft	Operating angle 10°	1 NO + 1 NC	B	3SE5 232-0HU21	1	1 unit
	Operating angle 10°	1 NO + 2 NC	B	3SE5 232-0LU21	1	1 unit



With solid shaft

With solid shaft	Operating angle 10°	1 NO + 1 NC	B	3SE5 232-0HU22	1	1 unit
	Operating angle 10°	1 NO + 2 NC	B	3SE5 232-0LU22	1	1 unit

Plastic enclosures · Enclosure width 40 mm acc. to EN 50041



With hollow shaft

With hollow shaft	Operating angle 10°	1 NO + 2 NC	B	3SE5 132-0LU21	1	1 unit
-------------------	---------------------	-------------	---	----------------	---	--------



With solid shaft

With solid shaft	Operating angle 10°	1 NO + 2 NC	B	3SE5 132-0LU22	1	1 unit
------------------	---------------------	-------------	---	----------------	---	--------

For online configurator see www.siemens.com/sirius/configurators.

Positive opening according to IEC 60947-5-1, Appendix K.

Spare parts

Version	DT	Order No.	Price per PU	PU (UNIT, SET, M)	PS*
---------	----	-----------	--------------	-------------------------	-----

Actuator heads



With hollow shaft

With hollow shaft	Operating angle 10°	B	3SE5 000-0AU21	1	1 unit
-------------------	---------------------	---	----------------	---	--------



With solid shaft

With solid shaft	Operating angle 10°	B	3SE5 000-0AU22	1	1 unit
------------------	---------------------	---	----------------	---	--------

Note:

The respective actuators are included in the scope of supply for the complete units.

Mechanical Safety

SIRIUS 3SE5 Hinge Switches

3SE5, metal enclosures
Enclosure width 31 mm / 40 mm

1
2
3
4
5
6
7
8
9
10
11
12
13

Selection and ordering data

Complete units

3 contacts · Degree of protection IP66/IP67 · Cable entry M20 × 1.5

Version	Snap-action contacts	DT	Complete units	<input type="checkbox"/> PU (UNIT, SET, M)
			Configurator	
		Order No.	Price per PU	

Metal enclosures · Enclosure width 31 mm acc. to EN 50047



With hollow shaft

With hollow shaft	Operating angle 10°	1 NO + 2 NC	⊕ B	3SE5 212-0LU21	1
-------------------	---------------------	-------------	-----	----------------	---



With solid shaft

With solid shaft	Operating angle 10°	1 NO + 2 NC	⊕ B	3SE5 212-0LU22	1
------------------	---------------------	-------------	-----	----------------	---

Metal enclosures · Enclosure width 40 mm acc. to EN 50041



With hollow shaft

With hollow shaft	Operating angle 10°	1 NO + 2 NC	⊕ B	3SE5 112-0LU21	1
-------------------	---------------------	-------------	-----	----------------	---



With solid shaft

With solid shaft	Operating angle 10°	1 NO + 2 NC	⊕ B	3SE5 112-0LU22	1
------------------	---------------------	-------------	-----	----------------	---

For online configurator see www.siemens.com/sirius/configurators .

⊕ Positive opening according to IEC 60947-5-1, Appendix K.

Spare parts

Version	DT	Order No.	Price per PU	PU (UNIT, SET, M)	PS*
---------	----	-----------	--------------	-------------------	-----



With hollow shaft

With hollow shaft	Operating angle 10°	B	3SE5 000-0AU21	1	1 unit
-------------------	---------------------	---	----------------	---	--------



With solid shaft

With solid shaft	Operating angle 10°	B	3SE5 000-0AU22	1	1 unit
------------------	---------------------	---	----------------	---	--------

Note:

The respective actuators are included in the scope of supply for the complete units.

Mechanical Safety

3SE2 Hinge Switches

3SE2, plastic enclosures with integrated hinge

Overview

The 3SE2 283 hinge switches are particularly suitable for use in doors and flaps of machines that must be closed to ensure the safety of operating personnel. Their thin profile and compact design allow them to be directly mounted on a hinged protective cover and the stable frame.

Benefits

- Easy mounting through use of versions with integrated hinge
- Versions with small operating angle of 4°
- Protection against personal injury provided by positively driven NC contacts according to IEC 60947-5-1
- Simultaneous shutdown and reporting by 1 NO + 2 NC contacts

Selection and ordering data

3 contacts · Degree of protection IP65 · Cable entry 2 × (M20 × 1.5)

Version	Slow-action contacts	DT	Complete units	<input type="checkbox"/>	PU (UNIT, SET, M)	PS*	PG	Weight per PU approx.
			Order No.	List Price \$ per PU				kg

Plastic enclosures with integrated hinge



3SE2 283

With mounted hinges
(delivered with additional hinge and fixing accessories)

- Aluminum hinge

Operating angle	Contacts	DT	Order No.	PU (UNIT, SET, M)	PS*	PG	Weight per PU approx.
- Operating angle 4°	1 NO + 2 NC	⊕ A	3SE2 283-0GA43	1	1 unit	102	0.425
- Operating angle 4°	3 NC	⊕ A	3SE2 283-6GA43	1	1 unit	102	0.425
- Operating angle 8°	1 NO + 2 NC	⊕ D	3SE2 283-0GA53	1	1 unit	102	0.420
- Operating angle 8°	3 NC	⊕ C	3SE2 283-6GA53	1	1 unit	102	0.420

- High-grade steel hinge

Operating angle	Contacts	DT	Order No.	PU (UNIT, SET, M)	PS*	PG	Weight per PU approx.
- Operating angle 4°	1 NO + 2 NC	⊕ A	3SE2 283-0GA44	1	1 unit	102	0.800
- Operating angle 4°	3 NC	⊕ C	3SE2 283-6GA44	1	1 unit	102	0.800

⊕ Positive opening according to IEC 60947-5-1, Appendix K.

Accessories/spare parts

Version	DT	Order No.	List Price \$ per PU	PU (UNIT, SET, M)	PS*	PG	Weight per PU approx.
							kg

Accessories



3SX3 225

Additional hinges
(delivered with fixing accessories)

- Made of aluminum
- Made of high-grade steel

DT	Order No.	PU (UNIT, SET, M)	PS*	PG	Weight per PU approx.
⊕ D	3SX3 225	1	1 unit	102	0.160
⊕ D	3SX3 231	1	1 unit	102	0.330

For 1/2" NPT adaptors and cable glands, see page 13/48.

Configuration

Contact blocks and operating travel of actuators

Contact blocks	Nominal travel	Contact blocks	Nominal travel
Terminal designation acc. to EN 50013	 Contact closed Contact open	Terminal designation acc. to EN 50013	
Hinge switches		Snap-action contacts	
1 NO + 1 NC Ident. No. 11	3SE5 ...-0HU2. NSCO_00918 13-14 21-22 **	1 NO + 2 NC Ident. No. 12	3SE5 ..-0LU2. NSCO_00919 13-14 21-22 ** 31-32 **

Dimensional drawings

Enclosure width 31 mm with hollow shaft
3SE5 212-0.U21, 3SE5 232-0.U21

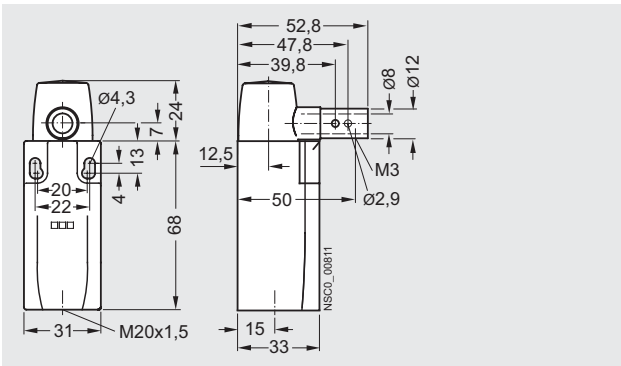

Enclosure width 31 mm with solid shaft
3SE5 212-0.U22, 3SE5 232-0.U22

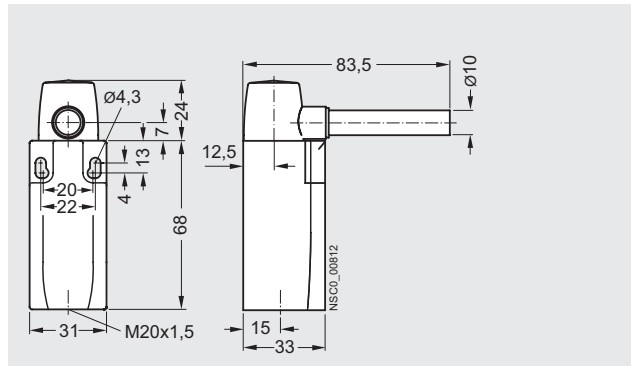

Enclosure width 40 mm with hollow shaft
3SE5 112-0.U21, 3SE5 132-0.U21

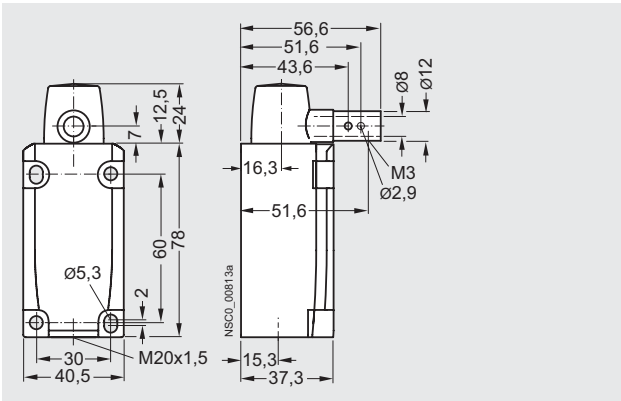

Enclosure width 40 mm with solid shaft
3SE5 122-0.U22, 3SE5 132-0.U22

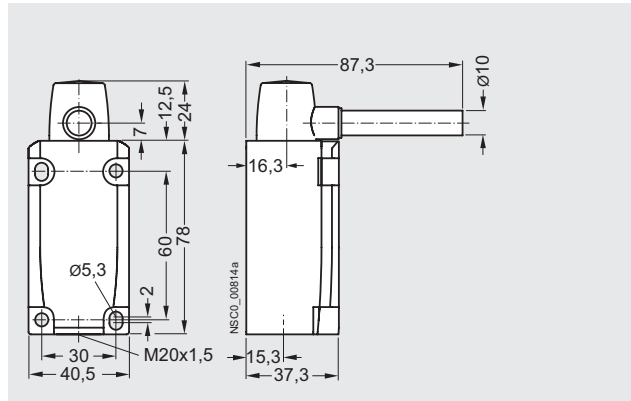

Mechanical Safety

3SE2 Hinge Switches

3SE2, plastic enclosures with integrated hinge

Overview

The hinge switches are used for monitoring and protecting hinged protective devices such as doors and flaps.

Characteristics

- Special design, with 2 × M20 × 1.5 connecting thread
- Degree of protection IP65
- 3 contacts
- Operating angle of 4° or 8°

Design

The 3SE2 283 hinge switch has an integrated electromechanical contact block that is actuated when the hinged protective cover is opened. If the cover is opened by 4° or 8°, the NC contact is positively opened by a direct (not spring-action) mechanism. These positively driven contacts guarantee interruption of the electric circuit and stopping of the machine. The NO contact is closed when the cover is moved by 13.5°.

Technical specifications

Type	3SE2 283	
Rated insulation voltage U_i	V	250
Conventional thermal current I_{th}	A	2.5
Rated operational current I_e		
• At AC-15, 120 V	A	4.2
• At AC-15, 250 V	A	2
• At DC-13, 24 V	A	1
Min. make-break capacity	> 5 V/1 mA	
Short-circuit protection		
• Operational class gG	A	2
Mechanical endurance	> 1 × 10 ⁶ operating cycles	
Switching frequency	1200 operating cycles/hour	
Positive opening	2 mm after opening point	
Enclosure material	Plastic	
Degree of protection	IP65	
Ambient temperature	°C	-25 ... +65
Shock resistance	30 g/18 ms	
Resistance to vibrations	20 g/10 ... 200 Hz	
Cable entry	2 × (M20 × 1.5)	
Screw terminals	0.5 ... 1.5 mm ² /AWG 15	

Configuration

Contact blocks and operating travel of actuators (operating angle 4°)

Contact blocks	Nominal travel	Contact blocks	Nominal travel
Terminal designation acc. to EN 50013		Terminal designation acc. to EN 50013	
Hinge switches		Slow-action contacts	
1 NO + 2 NC Ident. No. 12	3SE2 283-0GA4. NSC0_00614a	3 NC Ident. No. 03	3SE2 283-6GA4. NSC0_00615a

Dimensional drawings

3SE2 283-.GA.3 hinge switch with hinge

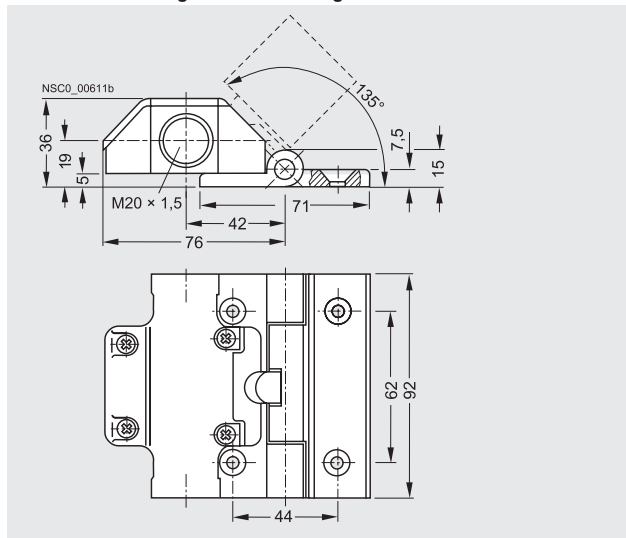

3SX3 225 additional hinge

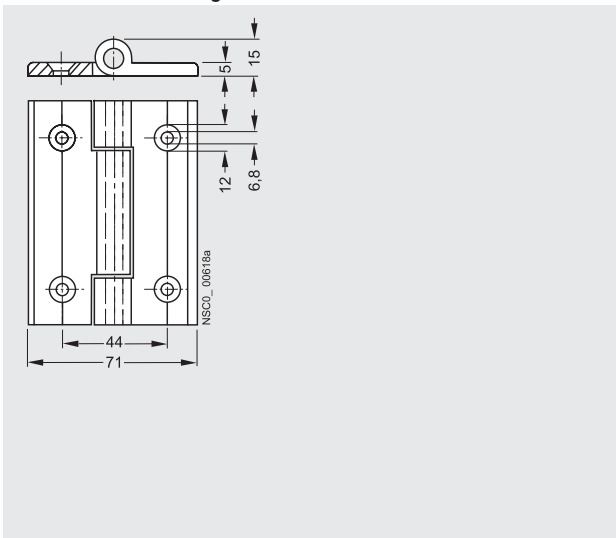

Overview



Non-contact RFID safety switches with maximum tamper resistance

3SE63 RFID contactless safety switches meet the highest safety requirements, SIL3 or Cat. 4, for monitoring the positions of movable protective devices.

An RFID safety switch consists of a coded RFID switch with an 8-pole M12 connector plug and an identical RFID actuator.

The switch is available in several versions:

- Family coded with M12 plug or with additional 18 N magnetic catch as an option
- Individually coded, programmable once, with M12 plug or with additional 18 N magnetic catch as an option
- Individually coded, programmable more than once (an unlimited number of times), with M12 plug or version with additional 18 N magnetic catch

The actuator is therefore available in two versions:

- Standard
- With 18 N magnetic catch

The magnetic catch keeps doors and hinge switches closed with permanent magnets.

Optional accessories

- Covers for sealing mounting holes, also suitable for tamper-proofing screw fixings
- Spacers (approx. 3 mm high) to facilitate cleaning under the installation surface when using pressure washers, for example

Mounting and maintenance

Reduction in the number of versions, because

- switches can be mounted on right or left sides
- the actuator can be mounted on all sides

Quick and easy mounting by thanks to universal mounting holes

- Standard gauge/holes for 3SE6 magnetically operated switch
- Fine adjustment thanks to slotted holes

Little adjustment or maintenance required

- Threshold indication by LED on the switch for quick and easy adjustment during installation and maintenance
- Molded switch allows it to be used as an end stop for small and medium-sized doors

Note:

Keep metal parts and cuttings away from the vicinity of the switch

Minimum distance between two switches 100 mm

Coding

Family coded

These safety switches are delivered ready to use, i.e. no programming is necessary.

Individually coded, programmable once

The assignment of safety switch and actuator thus created is irreversible.

The actuator is programmed simply by routine during startup, thus permanently preventing any form of tampering by means of a replacement actuator.

Individually coded, programmable several times

The procedure for programming a new actuator can be repeated an unlimited number of times. When a new actuator is programmed the previous code becomes invalid. A protected coding process allows new actuators to be programmed for service purposes.

After this, a ten-minute lockout provides enhanced tamper protection. The green LED flashes until the lockout time has ended and the new actuator has been detected. If the operational voltage is interrupted during this time, the ten-minute guard time is restarted.

Programming procedure for individual coding

1. Apply operational voltage to safety sensor
2. Move actuator into detecting range: red LED lights up, yellow LED flashes (1 Hz)
3. After 10 s it changes to a shorter flashing frequency (3 Hz). In this state switch off operational voltage.
4. After the next time the operational voltage is switched on, the actuator is detected again to activate the programmed actuator code. The activated code is thus stored permanently.

Diagnostics

The RFID safety switch indicates its operating state including faults by means of the LED indicator in the switch and the short-circuit resistant diagnostic output. The signals can then be used for central displays or non-safety-related control tasks.

There are two diagnostics functions:

- Crossover monitoring
- Open-circuit monitoring
- External voltage monitoring
- Ambient temperature too high
- Wrong or defective actuator
- Switching interval threshold identification with LED indication

The signal combination "diagnostics output switched off" and "safety outputs still switched on" can be used to move the machine into a controlled stop position.

Any crossover or a fault that is not currently compromising the safe operation of a safety switch results in the disconnection of the safety channels after a 30 minute delay. However, the diagnostics output switches off instantaneously.

Mechanical Safety

SIRIUS 3SE6 RFID Non-Contact Safety Switches

General data

Mode of operation of the diagnostics LEDs

The safety switch indicates not only its operating state, but also faults by means of LEDs in three colors at the ends of the RFID switch.

- The green LED indicates readiness for operation when the control supply voltage is connected.
- The yellow LED indicates that there is an actuator in detecting range. If the actuator is in the switching interval threshold, this is indicated by flashing. This flashing can be used to identify a change in the distance between sensor and actuator at an early stage (e.g. as a result of the sagging of a protective door). The installation should be tested before the distance increases further, the safety outputs switch off and the machine stops.
- The red LED indicates the individual causes of the fault by means of defined flashing frequencies.

Benefits

- Maximum tamper resistance by means of individual coding of switches and actuators at the highest safety level
- Plastic enclosure with integrated connector
- 2 electronic short-circuit proof safety outputs, each 250 mA
- Integrated crossover, open circuit and external voltage monitoring, with series circuit as far as the control cabinet
- Safety and diagnostics signals can be connected in series
- Series connection of safety circuits in Cat. 4 / PL e / SIL 3
- LED status indication including switching interval threshold indication for quick and easy adjustment during installation and maintenance
- Short-circuit proof conventional diagnostics output
- Optional version with magnetic catch for interlocking hatches or small doors even when de-energized

- Highly rugged thanks to the use of tested enclosure materials, resistant to aggressive cleaning products, with a degree of protection of up to IP69K
- Fine adjustment thanks to slotted holes
- Little adjustment or maintenance required
- Molded switch allows it to be used as an end stop for small and medium-sized doors

Application

RFID contactless safety switches are designed for use in safety circuits, and are used to monitor the positions of movable protective devices. They monitor the positions of rotating, laterally sliding or removable protective devices using the coded electronic actuator.

Their high degree of protection (IP69K) and the use of cleaning product-resistant materials means that these switches are optimized for use under extreme environmental conditions.

Their electronic operating principle makes these switches ideal for metalworking machinery.

The switches have a larger switching interval and switching displacement than mechanical switches, improve the mounting tolerance of the protective door, and offer a wide range of diagnostics options.

The RFID switches can be connected to all standard evaluation units, e.g. a PLC, 3TK28 safety evaluation units (in which the built-in crossover monitoring function can be deactivated), or the 3RK3 modular safety system.

The following safety categories can be achieved in safety circuits:

- Category 4 according to EN ISO 13849-1 (EN 954-1)
- PL e according to EN ISO 13849-1
- SIL 3 according to IEC 61508

Technical specifications

Type	3SE6 3	
General data		
Standards	IEC 60947-5-3, IEC 61508, EN ISO 13849-1	
Enclosure material	Fiber-glass strengthened thermoplast, self-extinguishing	
Degree of protection	IP69K	
Ambient temperature		
• During operation	°C	-25 ... +70
• During storage, transport	°C	-25 ... +85
Shock resistance	30 g/11 ms	
Vibration resistance	10 ... 55 Hz amplitude 1 mm	
Electrical specifications		
Rated insulation voltage U_i	V	32
Pollution degree acc. to IEC 60664-1		3
Rated impulse withstand voltage U_{imp}	V	800
Rated conditional short-circuit current	A	100
Rated operational voltage U_e (PELV acc. to IEC 60204-1)	V DC	24 – 15/+10 %
Protection class	II	
Overvoltage category	III	
Rated operational current I_e	A	0.6
Smallest operational current I_m	mA	0.5
No-load supply current I_0	mA	35

Type	3SE6 3	
Inputs/outputs		
Safety inputs X1/X2		
• Input voltage	V DC	24 – 15/+10 %
• Power consumption per input	mA	5
Safety outputs OSSD1/OSSD2		
		p operation
• Max. rated operational current I_e	A	0.25
• Rated operational current $I_e/DC-12/DC-13$ at U_e	A	0.25
• Voltage drop U_e	V	< 1
• Switching frequency	Hz	1
• Response time, max.	ms	100
• Risk time, max.	ms	200
• Recovery, max.	s	5
Diagnostics output		
		p operation
• Max. rated operational current $I_{e2\max}$	A	0.05
• Rated operational current $I_e/DC-12/DC-13$ at U_e	A	0.05
• Voltage drop U_e	V	< 2
• Operational current	mA	150
• Conductor capacity, max.	nF	50

Mechanical Safety

SIRIUS 3SE6 RFID Non-Contact Safety Switches

Technical data

1
2
3
4
5
6
7
8
9
10
11
12
13

Directions of approach and switching interval

The side area permits a maximum height offset of the switch and actuator of ± 8 mm (e.g. mounting tolerance or due to sagging of the protective door). The transverse offset also equals max. ± 8 mm.

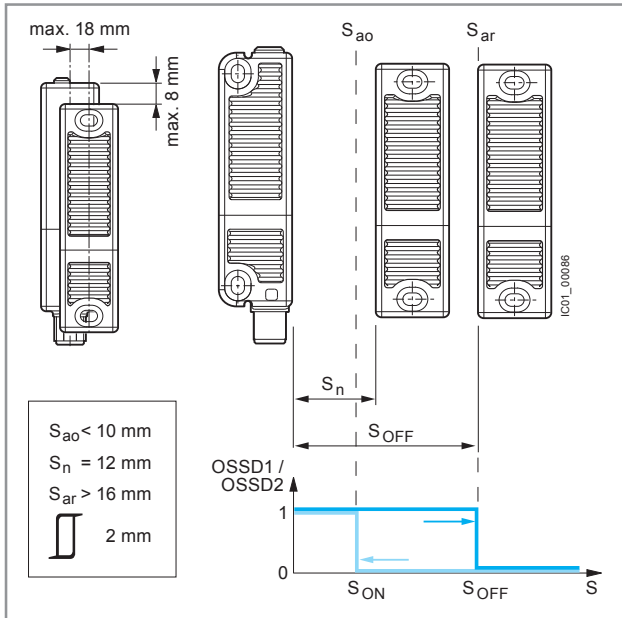

Switching interval: output signal with hysteresis

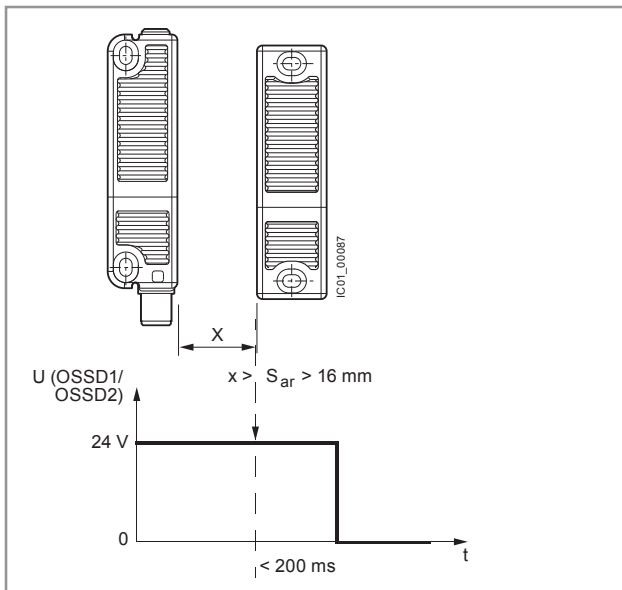

Switching interval: Output signal

Connector assignment

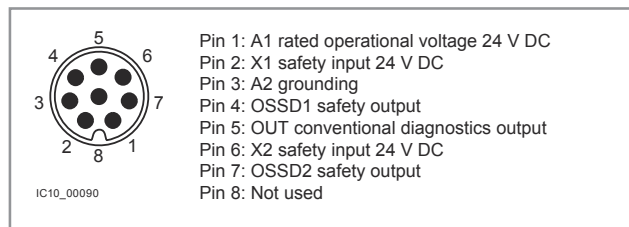

Dimensional drawings

RFID switches 3SE6 315

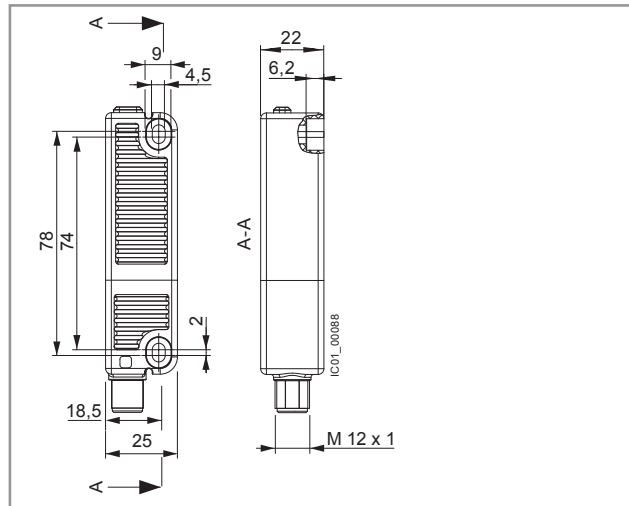

RFID actuator 3SE6 310

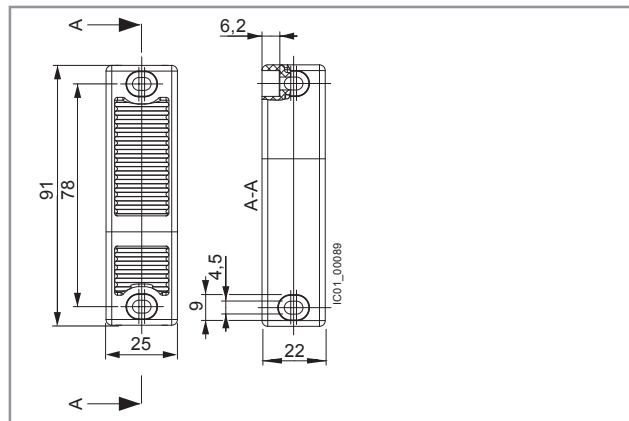





Mechanical Safety

SIRIUS 3SE6 RFID Non-Contact Safety Switches

Selection

Selection and ordering data

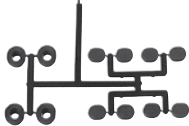
With M12 connector, 8-pole

Version/coding	Latching / length	DT	Order No.	Price per PU	PU (UNIT, SET, M)	PS*
Rectangular safety switches 91 mm x 25 mm						
RFID safety switches						
 <p>3SE6 315</p>	• Family coded	None	▶ 3SE6 315-0BB01		1	1 unit
		With 18 N magnetic catch	▶ 3SE6 315-1BB01		1	1 unit
	• Individually coded, programmable several times	None	▶ 3SE6 315-0BB02		1	1 unit
		With 18 N magnetic catch	▶ 3SE6 315-1BB02		1	1 unit
	• Individually coded, programmable once	None	▶ 3SE6 315-0BB03		1	1 unit
		With 18 N magnetic catch	▶ 3SE6 315-1BB03		1	1 unit
RFID actuators						
 <p>3SE6 310</p>	• Standard	None	▶ 3SE6 310-0BC01		1	1 unit
		With 18 N magnetic catch	▶ 3SE6 310-1BC01		1	1 unit
Optional accessories						
 <p>3SX5 600-1G</p>	Covers and spacers		A 3SX5 600-1G		1	1 unit
		One pack (1 unit) contains 8 covers and 4 spacers				
 <p>3SX5 601-2GA</p>	Connecting cables, 8-pole, with 1 straight M12 socket	Length 3 m	A 3SX5 601-2GA03		1	1 unit
		Length 5 m	A 3SX5 601-2GA05		1	1 unit
		Length 10 m	A 3SX5 601-2GA10		1	1 unit
	Rated voltage 30 V					
	Rated current 2 A					

For monitoring units see Chapter 14, "Industrial Communication"

Overview



Switching magnets and contact blocks

A magnetically operated switch is comprised of a coded switching magnet and a contact block (sensor unit). Evaluation requires a safety relay or connection to a bus system.

3SE6 806 safety relays

Up to six protective devices (sensors) can be connected to the safety relay.

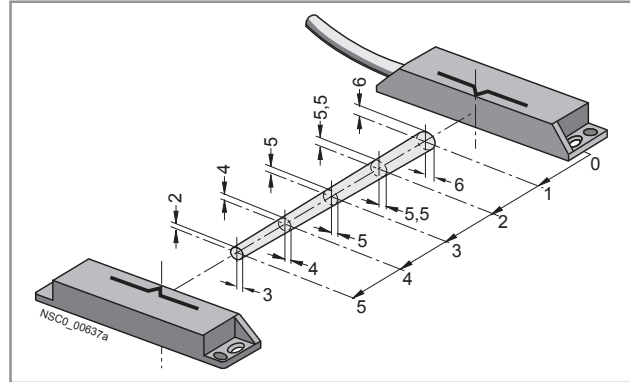

Enabling range (example)

The device has six current-sourcing semiconductor outputs (Y1 ... Y6) which signal the state of the connected protective devices.

The 3SE6 806 safety relay has two floating enabling circuits (safe circuits) as NO contact circuits and one floating signaling circuit as a NC circuit. The number of enabling circuits can be increased by adding one or more 3TK28 30 expansion modules.

Application

SIRIUS 3SE6 magnetically operated switches are designed for mounting on movable protective guards (hoods, hinge switches, doors, etc.). Evaluation can be performed by means of a safety relay or through connection to a bus system.

The 3SE6 6 non-contact, magnetically operated safety switches stand out due to their enclosed design with degree of protection IP67. They are particularly suitable therefore for areas exposed to contamination, cleaning or disinfecting.

A magnetic monitoring system comprises one or more magnetically operated switches and an evaluation unit, e.g. a safety relay. When contact blocks 1 NO + 1 NC are used the 3SE6 806 safety relay provides a high degree of protection against manipulation and can be installed in safety circuits up to Category 3 according to ISO 13849-1 (EN 954-1).

Combination of monitoring units and magnetically operated switches

Monitoring units	Magnetically operated switches (contact block + switching magnet)					Achievable category (EN 954-1)/ Performance level (EN ISO 13849-1)		
	1 NO + 1 NC	2 NC	1 NO + 2 NC	3SE6 605-1BA	3SE6 605-2BA		3SE6 605-3BA	3SE6 604-2BA
Relay outputs								
SIRIUS safety relays, 6-fold	3SE6 806-2CD00					Cat. 3		
SIRIUS safety relays	3TK28 20			✓		Cat. 4/e		
	3TK28 26	✓	✓	✓	✓	Cat. 4/e		
Solid-state outputs								
SIRIUS safety relays	3TK28 40				✓	Cat. 3/d		
	3TK28 41, 3TK28 42, 3TK28 45				✓	Cat. 4/e		
SIRIUS safety relays with contactor relay	3TK28 50, 3TK28 51, 3TK28 52				✓	Cat. 3/d		
	3TK28 53				✓	Cat. 4/e		
ASIsafe compact safety modules	3RK1 205, 3RK1 405				✓	Cat. 4		
SIMATIC S7-31xF-2 DP or SIMATIC ET 200M	SM 326 F, 24 DI, 24 V DC, SM 326 F, 8 DI, NAMUR	✓	✓	✓	✓	Cat. 4		
SIMATIC ET 200S PROFIsafe	4/8 F-DI / 3 F-DO, 24 V DC	✓	✓	✓	✓	Cat. 3		
	4/8 F DI, 24 V DC	✓	✓	✓	✓	Cat. 4		
SIMATIC ET 200eco	4/8 F DI, 24 V DC	✓	✓	✓	✓	Cat. 4		
SIMATIC ET 200pro	8/16 F-DI, 24 V DC, 4/8 F-DI / 4 F-DO 2 A, 24 V DC, F-Switch	✓	✓	✓	✓	Cat. 4		
Modular Safety System	3RK3	✓	✓	✓	✓	Cat. 4/e		







✓ Suitable magnetically operated switch

Mechanical Safety

3SE6 Magnetic Monitoring Systems

Selection

Selection and ordering data

Design		Size	S _{an} ... S _{ab}	Contacts	DT	Order No.	List Price \$ 1 unit	Weight approx. kg
		mm	mm					
Round sensor unit. IP67								
3SE6 704-1BA	3SE6 605-1BA	Switching magnet (coded)	M 30			3SE6 704-1BA		0.035
		Switch block with 3 m cable	M 30	5 to 15	1 NO + 1 NC	3SE6 605-1BA		0.166
		Switch block with M12, 4-pole male receptacle ¹⁾	M 30	5 to 15	1 NO + 1 NC	3SE6 605-1BA02		0.130
Rectangular sensor unit. IP67								
3SE6 605-2BA, 3SE6 704-2BA	3SE6 605-3BA, 3SE6 704-3BA	Switching magnet (coded)	25 × 88			3SE6 704-2BA		0.027
		Switch block with 1 m cable	25 × 88	5 to 15	1 NO + 1 NC 2 NC	3SE6 605-2BA 3SE6 604-2BA		0.165 0.165
		Switch block with M8 male receptacle	25 × 88	5 to 15	1 NO + 1 NC 2 NC	3SE6 605-2BA01 3SE6 604-2BA01		0.040 0.130
		Switching magnet (coded)	25 × 33			3SE6 704-3BA		0.014
		Switch block with 3 m cable	25 × 33	4 to 14	1 NO + 1 NC	3SE6 605-3BA		0.151
		Switch block with 3 m cable	25 × 33	4 to 14	1 NO + 2 NC	3SE6 606-3BA		0.151
Accessories								
3SX3 260	3SX3 261	Spacer for rectangular sensor unit	25 × 88			3SX3 260		0.015
		Spacer for rectangular sensor unit	25 × 33			3SX3 261		0.010
Monitoring units								
3SE6 806-2CD00		Rated control supply voltage	Width	Enable circuits/ signal. circuits	Max. number of connectable sensors	Order No.	List Price \$ 1 unit	Weight approx. kg
		DC V	mm					
		24		2 NO / 1 NC	6 1 NO + 1 NC	3SE6 806-2CD00		0.200

1) Pin 1 (S21) + Pin 2 (S22) = Normally Closed; Pin 3 (S13) + Pin 4 (S14) = Normally Open
Typical 4-pole Female Plugs with black 5 meter cable include: 3RX1542 (right-angle) or 3RX1513 (straight plug).

Technical specifications

Magnet Switches

Type	3SE6 60.-1BA 3SE6 60.-2BA	3SE6 60.-3BA
Form	M30, 25 mm x 88 mm	25 mm x 33 mm
Standards	DIN EN 50947-5-3 ³⁾	
Sensing type	Magnetic	
Rated voltage	AC/DC 100 V, 120 V	DC 24 V
Rated current	400 mA	100 mA
Performance	10 VA/W	1 W
Max. switching frequency	5 Hz	
Max. sensing distance S_{an} ... S_{ab}	5 ... 15 mm	4 ... 14 mm
Housing material	Fiber-glass strengthened with glass fiber	
Degree of protection acc. to IEC 60529	IP67	
Permissible ambient temperature	<ul style="list-style-type: none"> • Operating -25 to +70 °C • Storage -25 to +70 °C 	
Shock resistance	10 g/11ms	
Vibration resistance	10 ... 55 Hz, 1 mm amplitude	
Conductor	Cable LiYY 4 x 0.25 mm ² 3 m length	
Receptacle, male	M12, M8	-
Cable length (max for connecting to monitoring unit)	1000 m	100 m

Magnet Switch Monitoring Unit

Type	3SE6 806-2CD00
Standards	EN ISO 13849-1, EN 1088
Rated control supply voltage U_c	DC 24 V
Rated control supply voltage tolerance	0.85 ... 1.2 x U _s
Rated power (without signal outputs Y1 ... Y6)	3 W
Maximum load current	<ul style="list-style-type: none"> • Signaling circuit Y1 ... Y6 20 mA • Signaling circuit 31, 32 2 A
Inputs	6 sensors (1 NO or 1 NC)
Outputs	6 signaling outputs 1 relay output 2 enabling circuits
Response time	<ul style="list-style-type: none"> • Automatic start 150 ms typical • Manual start 25 ms typical
Release time	20 ms max.
Recovery time	350 ms
Degree of protection to IEC 60529	IP20
Switching capacity¹⁾	Release circuits (13, 14 and 23, 24) Continuous current, I _{th} 6 A Rated operational current, I _e ²⁾ <ul style="list-style-type: none"> • AC-15 @ 203 V 6 A • DC-13 <ul style="list-style-type: none"> - 24 V 6 A - 115 V 0.2 A - 230 V 0.1 A
Short circuit protection	DIAZED <ul style="list-style-type: none"> • Fuse type • Duty class <ul style="list-style-type: none"> - gL(gC) 6 A - Quick response 10 A
Permissible ambient temperature, T_u	<ul style="list-style-type: none"> • Operating -25 to +45 °C • Storage -25 to +70 °C

1) Utilization category per DIN VDE 0660, Part 200, IEC 60947-5-1
2) With all release circuits loaded

3) In combination with monitoring unit or AS-Interface.

Mechanical Safety

3SE6 Magnetic Monitoring Systems

Dimensional drawings

Dimension drawings

Round sensor units

Switch block 3SE6 605-1BA

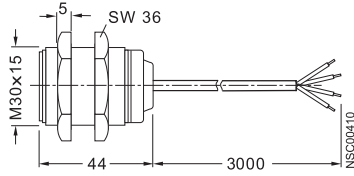

Switch block 3SE6 605-1BA02

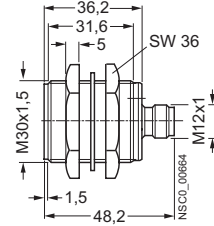

Coded switching magnet 3SE6 704-1BA

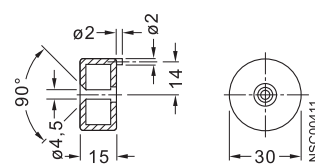

Rectangular sensor units

Switch block 3SE6 605-2BA

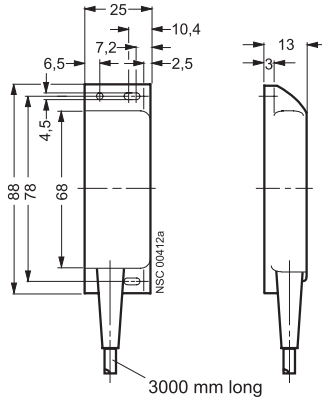

3000 mm long

Switching magnet without lead

Switch block 3SE6 60.-2BA0.

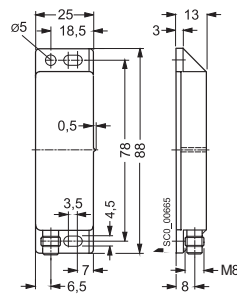

Switch block 3SE7 704-2BA

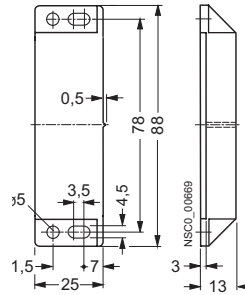

3SX3 260 spacer

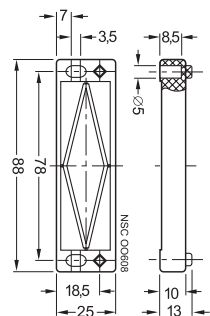

Switch block 3SE6 605-3BA

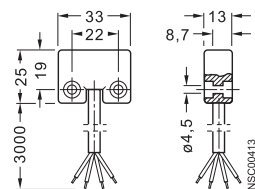

Coded switching magnet 3SE6 704-3BA

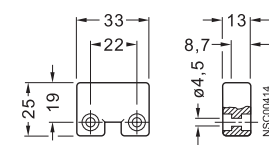

3SX3 261 spacer

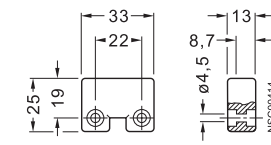

Monitoring unit

Magnet Switch Monitor 3SE6 806-2CD00

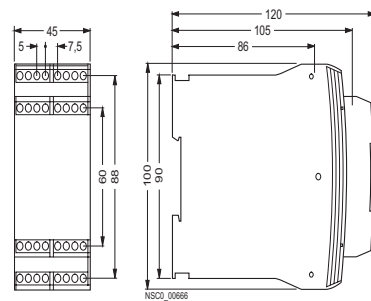

Circuit diagrams

Connection example

Single Channel Control, Manual Start, Category 3 to EN ISO 13849-1

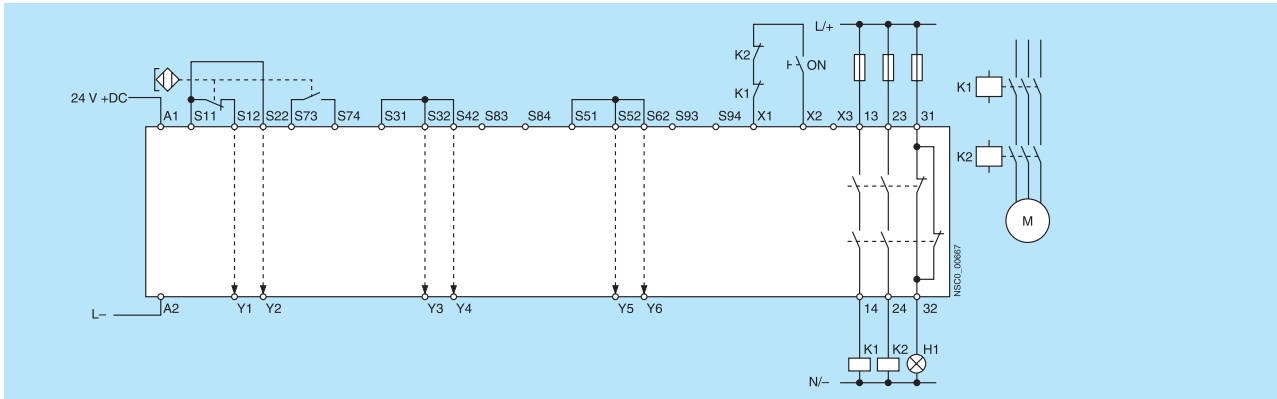

Six Channel Control. Automatic Start, Category 3 to EN ISO 13849-1

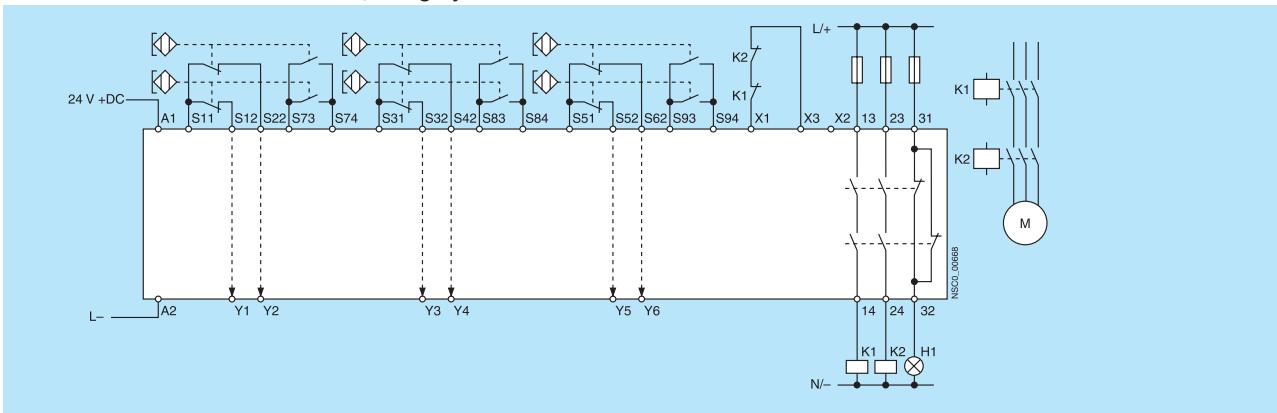

Terminal Assignments

Power	A1+, L+	U_s
	A2-, L-	24 V DC
Sensors	S11, S12	Channel 1, NC contact
	S11, S22	Channel 2, NC contact
	S31, S32	Channel 3, NC contact
	S31, S42	Channel 4, NC contact
	S51, S52	Channel 5, NC contact
	S51, S62	Channel 6, NC contact

Sensors (Cont.)	S73, S74	Channel 1+2, NO contact (parallel)
	S83, S84	Channel 3+4, NO contact (parallel)
	S93, S94	Channel 5+6, NO contact (parallel)
Outputs	13, 14	Release circuit 1 (safety NO contact)
	23, 24	Release circuit 2 (safety NO contact)
	31, 32	Floating signaling circuit
	Y1 to Y6	Status of Channels 1 through 6

3SE6 604-2BA magnetically operated switch with 3TK28 safety relay, Category 4 to EN ISO 13849-1

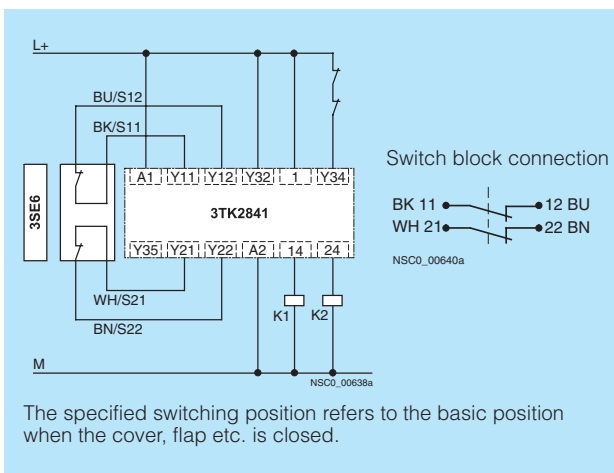

3SE6 604-2BA magnetically operated switch on AS-Interface Safety at Work, safe K45F or K60F compact module, Category 4 to EN ISO 13849-1

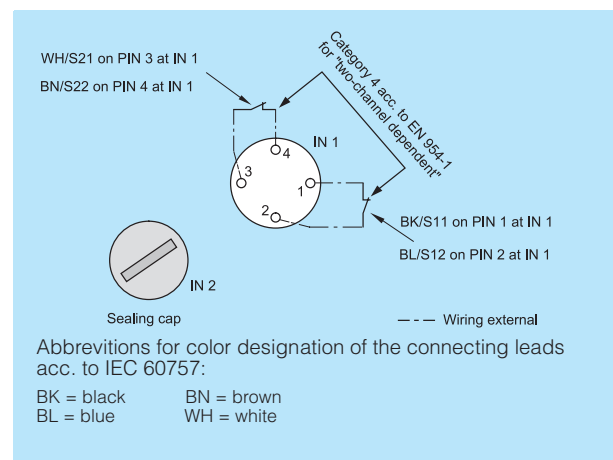

Mechanical Safety

3SB3 Two-Hand Control

Selection

Application

Two-hand operation consoles are required for use with machines and systems that have hazardous areas, in order to direct both hands of the operator to one position.

Operation consoles are primarily used on presses, stamping machines, printing presses and paper converting machines, in the chemical industry and in the rubber and plastics industries.

Specifications

Two-hand operation consoles fulfill the requirements laid down in DIN 24 980 and EN 574.

Construction

Equipment

All consoles are pre-equipped with SIGNUM 3SB3 control devices. The metal version is also available as an unequipped empty enclosure.

The plastic version can be retrofitted with up to 8 command points, in line with the customer's requirements. The surface of the console has premachined breaking points for this purpose.

Installation



The two-hand operation consoles can be mounted either on the stand available or directly on the machine by means of the holes in the rear panel.

Principle of operation

The control command is given by pressing the two operating elements simultaneously (within

0.5 s of each other) and must be maintained for as long as a hazard exists.

Selection and ordering data

Design	DT	Order No.	List Price \$ 1 unit	Weight approx. kg
3SB38 63-4BB 	SIGUARD two-hand operation console			
	Degree of protection IP 65, acc. to DIN 24 980 (EN 574), Standard equipment with 2 black operating elements (mushroom button 3SB30 00-1GA11, Ø 40 mm, 1 NO + 1 NC) and a red EMERGENCY-STOP mushroom button 3SB30 00-1HA20, latching Ø 40 mm, 2 NC			
	<ul style="list-style-type: none"> • Metal version <ul style="list-style-type: none"> - with standard equipment - with standard equipment and 4 additional holes for control devices 22.5 mm - empty enclosure, unequipped 			
	<ul style="list-style-type: none"> • Plastic version <ul style="list-style-type: none"> - with standard equipment and predetermined breaking points for 8 further command points 22.5 mm - with cable inlet holes for metric screwed cable glands 			
		3SB38 63-4BB		4.800
		3SB38 63-4BA		4.800
		3SB38 63-4BC		4.800
		3SB38 63-1BB3		2.300
3SB39 01-0AQ 	Stand for SIGUARD two-hand operation consoles			
	<ul style="list-style-type: none"> • with cable inlet holes for metric screwed cable glands 			
		3SB39 01-0AQ3		4.500

Dimension drawings

3SB38 63-4 operator panel with metal enclosure

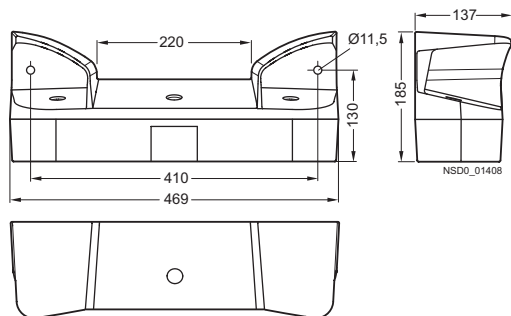

3SB39 01-0AQ stand

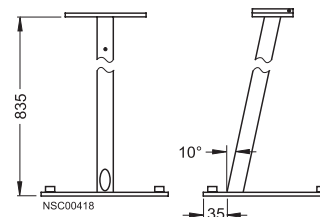

Note:

Also available with AS-Interface connection, contact your local Siemens representative.

Overview



SIRIUS 3SK1 safety relays

SIRIUS 3SK1 safety relays are the key components of a consistent, cost-effective safety chain. Whether you need EMERGENCY-STOP, protective door monitoring, light arrays, laser scanners or the protection of presses or punches – with the 22.5 mm wide SIRIUS safety relays every safety application can be implemented to optimum effect in terms of engineering and price.

The following safety-oriented functions are available:

- Monitoring the safety functions of sensors
- Monitoring the sensor leads
- Monitoring correct functioning of safety relays
- Monitoring the actuators in the shutdown circuit
- Safety-oriented disconnection when dangers arise

SIRIUS 3SK1 safety relays satisfy the most stringent requirements of IEC 61508/IEC 62061 (SIL 3) and EN ISO 13849-1 (PL e).

SIRIUS 3SK1 safety relays stand out due to their flexibility in both parameterization and system configurations with several evaluation units. Optimized solutions when selecting components are facilitated by a clearly structured component range:

- Standard basic units
- Advanced basic units
- Output expansions
- Input expansions
- Accessories

The 3SK1 Standard basic units are characterized by the following features:

- Compact design
- Simple operation
- Relay and semiconductor outputs
- Economical solution

However, the 3SK1 Advanced basic units also offer the following:

- Universal application options thanks to multi-functionality
- Time-delayed outputs
- Expansion of inputs and outputs

In the case of Advanced basic units, the 3ZY1 device connector allows safety functions involving several sensors and actuators to be constructed very quickly.

The 3SK1 Standard and Advanced series are a high-quality replacement for the 3TK28 safety relays. In their slimmer design, and equipped with greater functionality, they can replace every 3TK28 device. The only exceptions are devices with special functions, such as 3TK28 26, 3TK28 45 and the 3TK28 10 devices. For a code conversion table from 3TK28 to 3SK1 [see page 13/127](#)

Safety Relays

SIRIUS 3SK1

General Data

Function overview of the 3SK1 series

Type	Standard basic units		Advanced basic units	
	Relay enabling circuits	Solid-state enabling circuits	Relay enabling circuits	Solid-state enabling circuits
Sensors				
• Mechanical	✓	✓	✓	✓
• Non-floating	✓	✓	✓	✓
• Antivalent	--	--	✓	✓
• Expandable	--	✓ by means of cascading	✓	✓
Parameters				
• Start (auto/monitored)	✓	✓	✓	✓
• Sensor connection 2 x 1-channel/ 1 x 2-channel	--	✓	✓	✓
• Cross-circuit detection	✓ by means of wiring	✓	✓	✓
• Start-up test ON/OFF	--	✓	✓	✓
• Monitoring of two-hand operation consoles	--	--	✓	✓
Enabling circuits				
• Instantaneous	✓	✓	✓	✓
• Delayed	--	--	✓	✓
• Expandable with relay enabling circuits	✓ by means of wiring	✓ by means of wiring	✓	✓
• Device connectors	--	--	✓	✓
Rated control supply voltage				
• 24 V DC	✓	✓	✓ ¹⁾	✓ ¹⁾
• 115 ... 240 V AC/DC	✓	--	✓ ¹⁾	✓ ¹⁾
✓ Available -- Not available				

¹⁾ Possible using 3SK1 230 power supply via device connector.

Order No. scheme

Digit of the Order No.	1st - 3rd	4th	5th	6th	7th	8th	9th	10th	11th	12th	
Safety relays	3SK										
Generation	□										
Device version	□										
Device series	□										
Type of outputs	□										
Connection type	□										
Rated control supply voltage	□										
Type of rated control supply voltage	□										
Time delay	□										
Example	3SK	1	1	2	1	-	1	A	B	4	0

Note:

The Order No. scheme is presented here merely for information purposes and for better understanding of the logic behind the order numbers.

For your orders, please use the order numbers quoted in the catalog in the selection and ordering data.

3SK1 12 and 3SK1 112 safety relays with DIP switch

The 3SK1 12 and 3SK1 112 safety relays are configurable safety relays. They are used as evaluation units for the typical safety chain (detecting, evaluating, disconnecting). DIP switches on the front can be used to set many different functions. Thus the 3SK1 12 and 3SK1 112 can be used universally.

OFF	Diagram	DIP switch No.	ON
Autostart sensor input		1	Monitored start sensor input
Without cross-circuit detection		2	With cross-circuit detection
2 x single-channel sensor connection		3	1 x two-channel sensor connection
With start-up test		4	Without start-up test

Number of safe outputs

	Relay enabling circuits		Solid-state enabling circuits		3ZY1 device connectors
	Instantaneous	Delayed	Instantaneous	Delayed	
3SK1 Standard basic units					
3SK1 111	3	--	--	--	--
3SK1 112	--	--	2	--	--
3SK1 Advanced basic units					
3SK1 120	--	--	1	--	✓
3SK1 121-.AB40	3	--	--	--	✓
3SK1 121-.CB4.	2	2	--	--	✓
3SK1 122-.AB40	--	--	3	--	✓
3SK1 122-.CB4.	--	--	2	2	✓
3SK1 expansion units					
3SK1 211	4	--	--	--	✓
3SK1 213	3	--	--	--	✓
✓ Available -- Not available					

Benefits

General

- Suitable for all safety applications because of its compliance with the highest safety requirements (SIL 3 PL e)
- Universal use thanks to adjustable parameters
- Worldwide use thanks to globally valid certificates
- Compact SIRIUS design
- Device connectors with standard rail mounting for flexible interconnectability and expandability
- Removable terminals for greater plant availability
- Yellow terminal covers clearly identify the device as a safety component.
- Sensor cable up to 2 000 m long allows it to be used in large-scale plants.

Relay outputs

- Different voltages can be switched through the floating contacts
- Higher currents can be switched with relay contacts

Solid-state outputs

- Wear-free
- Suitable for operation in fast switching applications
- Insensitive to vibrations and dirt
- Good electrical endurance

Power outputs (3SK1 213 output expansion)

- Different voltages can be switched through the floating contacts
- The power relay contacts allow currents of up to 10 A AC-15/DC-13 to be connected
- High mechanical and electrical endurance
- Protective separation between enabling circuits and between enabling circuits and electronics

3ZY1 device connectors

Using 3ZY1 device connectors to combine devices reduces the time required to configure and wire the components. At the same time errors are avoided during wiring, and this considerably reduces the testing required for the fully-configured application.

Microprocessor systems

- Flexible use thanks to many different integrated functions
- Easy parameterization using DIP switches on the front
- High functional reliability based on extensive monitoring functions
- Operated by the machine control system
- Also connection of non-contact sensors (light arrays, light barriers etc.)

Configuration and stock keeping

Variable setting options by means of DIP switches, a wide voltage range and a special power supply unit reduce the cost of keeping stocks and the considerations involved in configuration where the evaluation units to be selected are concerned.

Spring-type terminal with push-in functionality

Push-in connections are a form of spring-type terminals allowing fast wiring without tools for rigid conductors or conductors equipped with end sleeves.

As with other spring-type terminals, a screwdriver (with 3.0 mm x 0.5 mm blade) is required to disconnect the conductor. The same tool can also be used to wire finely-stranded or stranded conductors with no end finishing.

The advantages of the push-in terminals are found, as with all spring-type terminals, in speed of assembly and disassembly and vibration-proof connection. There is no need for the checking and tightening required with screw terminals.

Safety Relays

SIRIUS 3SK1

Standard basic units

Overview



3SK1 11 Standard basic units

The 3SK1 11 Standard basic units are characterized by simple, variable functionality. These devices are recommended for safety functions requiring only a few sensors and a small number of outputs on the safety relay.

Selection and ordering data



PU (UNIT, SET, M) = 1
PS* = 1 unit



3SK1 111-1AB30



3SK1 112-1BB40

Rated control supply voltage U_s		DT	Screw terminals 	DT	Spring-type terminals (push-in) 	
At 60 Hz At AC V	At DC V		Order No.	Price per PU	Order No.	Price per PU
Standard basic units with 3 relay enabling circuits						
24	24	A	3SK1 111-1AB30	A	3SK1 111-2AB30	
110 ... 240	110 ... 240	A	3SK1 111-1AW20	A	3SK1 111-2AW20	
Standard basic units with 2 safety-oriented semiconductor outputs						
--	24	A	3SK1 112-1BB40	A	3SK1 112-2BB40	

Overview



3SK1 12 Advanced basic units

The 3SK1 12 Advanced basic units form an innovative system landscape which allows even complex safety functions with large numbers of sensors and outputs to be configured using the device connectors. It is possible to increase both the number of inputs for sensors and the number of enabling circuits of the basic unit without the need for wiring between the devices.

Selection and ordering data

PU (UNIT, SET, M) = 1
PS* = 1 unit



3SK1 121-1AB40



3SK1 122-1AB40



3SK1 122-1CB41

Rated control supply voltage U_s at DC	Adjustable off-delay time	Number of outputs		Semiconductor outputs		DT	Screw terminals		DT	Spring-type terminals (push-in)	
		Instantaneous	Delayed	Instantaneous	Delayed		Order No.	Price per PU		Order No.	Price per PU
V	s										
Advanced basic units with relay outputs											
24	--	3	--	--	--	A	3SK1 121-1AB40	A	3SK1 121-2AB40		
24	0.05 ... 3	2	2	--	--	A	3SK1 121-1CB41	B	3SK1 121-2CB41		
24	0.5 ... 30	2	2	--	--	A	3SK1 121-1CB42	A	3SK1 121-2CB42		
24	5 ... 300	2	2	--	--	B	3SK1 121-1CB44	B	3SK1 121-2CB44		
Advanced basic units with semiconductor outputs											
24	--	--	--	1	--	A	3SK1 120-1AB40	A	3SK1 120-2AB40		
24	--	--	--	3	--	A	3SK1 122-1AB40	A	3SK1 122-2AB40		
24	0.05 ... 3	--	--	2	2	B	3SK1 122-1CB41	B	3SK1 122-2CB41		
24	0.5 ... 30	--	--	2	2	A	3SK1 122-1CB42	A	3SK1 122-2CB42		
24	5 ... 300	--	--	2	2	B	3SK1 122-1CB44	B	3SK1 122-2CB44		

Safety Relays

SIRIUS 3SK1

Output expansion units

Overview



3SK1 21 output expansion

The 3SK1 21 output expansions can be used for Standard and Advanced basic units.

3SK1 211 output expansion

The 3SK1 211 output expansion is used to expand the enabling circuits of a basic unit by adding another four enabling circuits. These enabling circuits have a switching capacity of AC-15 4 A at a switching voltage of 230 V. The devices can be connected to any 3SK1 basic unit by means of wiring. In addition the devices with a 24 V DC control supply voltage can also be connected to 3SK1 Advanced basic units by means of the 3ZY1 2 device connector.

3SK1 213 output expansion

The 3SK1 213 output expansion is used to expand the enabling circuits of a basic unit by adding three enabling circuits with high switching capacity. These enabling circuits have a switching capacity of AC-15 10 A at a switching voltage of 230 V. The devices can be connected to any 3SK1 basic unit by means of wiring. As with 3SK1 211, it is also possible to use the version with a control supply voltage of 24 V DC on the 3ZY1 2 device connector.

Note:

It is only possible to expand the Standard basic units by means of wiring. Advanced basic units can be expanded using the 3ZY1 2 device connector.

Benefits

- Perfect adaptation of the number of outputs
- Simple expansion of instantaneous and time-delayed outputs of Advanced basic units by means of device connector and slide switch on expansion module
- Expansion with power contacts for high AC-15/DC-13 currents in the control circuit
- No enabling circuit required in the evaluation unit to control the expansion modules
- No wiring of the feedback circuit to the expansion units
- Shorter installation times
- Less configuring and testing required

Selection and ordering data



PU (UNIT, SET, M) = 1
PS* = 1 unit



3SK1 211-1BB00



3SK1 213-1AB40

Rated control supply voltage U_s		Number of outputs, switching instantaneously	Rated operational current ¹⁾		Suitability for use of 3ZY1 2 device connector	DT	Screw terminals 		DT	Spring-type terminals (push-in) 	
At 60 Hz At AC	at DC		AC	DC			Order No.	Price per PU		Order No.	Price per PU
V	V		A	A							
4RO output expansions											
24	--	4	B300	R300	--	B	3SK1 211-1BB00	A	3SK1 211-2BB00		
--	24	4	B300	R300	✓	A	3SK1 211-1BB40	A	3SK1 211-2BB40		
110 ... 240	110 ... 240	4	B300	R300	--	A	3SK1 211-1BW20	B	3SK1 211-2BW20		
3RO output expansions											
--	24	3	A300	P300	✓	A	3SK1 213-1AB40	A	3SK1 213-2AB40		
115	--	3	A300	P300	--	B	3SK1 213-1AJ20	B	3SK1 213-2AJ20		
230	--	3	A300	P300	--	B	3SK1 213-1AL20	B	3SK1 213-2AL20		

- ✓ Available
-- Not available

¹⁾ For a detailed description of the NEMA Control Circuit Rating see page 19/7

Overview



3SK1 220 sensor expansion

With the input expansions

- 3SK1 220 sensor expansion
- 3SK1 230 power supply

the Advanced basic units can be made more flexible.

3SK1 220 input expansion

The 3SK1 220 input expansion allows additional sensors to be integrated easily and flexibly. The device monitors two 1-channel sensors or one 2-channel sensor, whatever their output technology (floating/single-ended).

3SK1 230 power supply

The 3SK1 230 power supply makes the 3SK1 devices universally usable, whatever control supply voltage is to be used.

Both devices can be combined with the 3SK1 12 basic units in the Advanced series without the need for wiring.

Note:

The 3SK1 220 sensor expansion can only be connected to the Advanced basic units by means of the 3ZY1 2 device connector.

Alongside the 3ZY1 2 device connector, the 3SK1 230 power supply can also be wired to act as a power supply for 3SK1 devices.

Benefits

- A wide voltage range of 110 ... 240 V AC/DC allows the devices to be used worldwide
- Low stock keeping due to low variance
- Flexible expansion of the number of sensors without the need for additional wiring between the devices
- Perfect adaptation of the number of inputs to suit the application
- Universally usable thanks to the wide range of adjustable parameters for sensor expansion (parameters as for Advanced basic units)

Selection and ordering data



PU (UNIT, SET, M) = 1
PS* = 1 unit



3SK1 220-1AB40



3SK1 230-1AW20

Version	DT	Screw terminals 	DT	Spring-type terminals (push-in) 	
		Order No.	Price per PU	Order No.	Price per PU
3SK1 220 input expansions					
Sensor expansions					
For safety-oriented expansion of the Advanced basic units by adding a further two-channel sensor or two single-channel sensors					
<u>Note:</u>					
Can only be used in conjunction with 3ZY1 2 device connectors, see page 13/124.					
	A	3SK1 220-1AB40	A	3SK1 220-2AB40	
3SK1 230 power supplies					
Power supplies					
For supplying Advanced basic units via 3ZY1 2 device connectors at voltages of 110 ... 240 V AC/DC					
	A	3SK1 230-1AW20	A	3SK1 230-2AW20	

Safety Relays

SIRIUS 3SK1

Accessories

Overview

The following accessories are available for SIRIUS 3SK1 safety relays:

- Device connectors
- Terminals
- Sealable covers
- Push-in lugs
- Adapters
- Connection cables
- Inscription labels
- Tools

Device connectors for 3SK1 12. and 3SK1 2..

The device connector allows several safety relays to be interconnected. The last device in a row is placed on a device termination connector. This closes the circuits that were configured with the connectors.

Device connectors are available in various versions specifically for the 3SK1 safety relays:

For type	Device connectors		Device termination connectors	
	3ZY1 212-1BA00 (type 1, width 17.5 mm)	3ZY1 212-2BA00 (type 1, width 22.5 mm)	3ZY1 212-2DA00 (type 1, width 22.5 mm)	3ZY1 212-0FA01 (type 2, set for enclosure 45 mm)
3SK1 Advanced basic units				
3SK1 120	✓	--	--	--
3SK1 121	--	✓	✓	--
3SK1 122	--	✓	✓	--
Output expansions				
3SK1 211	--	✓	✓	--
3SK1 213	--	--	--	✓
Input expansions				
3SK1 220	✓	--	--	--
3SK1 230	--	✓	--	--

✓ Available
-- Not available

Selection and ordering data

Version	DT	Order No.	Price per PU	PU (UNIT, SET, M)	PS*
---------	----	-----------	--------------	-------------------	-----

Device connectors for the electrical connection of SIRIUS devices in the industrial enclosure for fixing on TH 35 standard mounting rail



3ZY1 212-1BA00

Device connectors

- Type 1, 7-pole, 17.5 mm wide
- Type 1, 7-pole, 22.5 mm wide
- No function, width 22.5 mm

A	3ZY1 212-1BA00	1	1 unit
A	3ZY1 212-2BA00	1	1 unit
X	3ZY1 210-2AA00	1	1 unit



3ZY1 212-2DA00

Device termination connectors

- Type 1, 7-pole, 22.5 mm wide
- Type 2, 7-pole, 22.5 mm wide

A	3ZY1 212-2DA00	1	1 unit
▶	3ZY1 212-2FA00	1	1 unit

Device termination connector set

Type 2, 7-pole, width > 45 mm, comprising 3ZY1 212-2FA00 and 3ZY1 210-2AA00

A	3ZY1 212-0FA01	1	1 unit
---	-----------------------	---	--------

Terminals for SIRIUS devices in the industrial enclosure for fixing on TH 35 standard mounting rail



3ZY1 121-1BA00

Removable terminals

- 2-pole, screw terminals up to 2 x 1.5 mm² or 1 x 2.5 mm²
- 2-pole, screw terminals up to max. 2 x 2.5 mm² or 1 x 4 mm²
- 3-pole, screw terminals up to max. 2 x 1.5 mm² or 1 x 2.5 mm²
- 2-pole, push-in terminals up to max. 2 x 1.5 mm²
- 2-pole, push-in terminals up to max. 2 x 2.5 mm² or 1 x 4 mm²
- 3-pole, push-in terminals up to max. 2 x 1.5 mm²

A	3ZY1 121-1BA00	1	6 units
▶	3ZY1 122-1BA00	1	6 units
▶	3ZY1 131-1BA00	1	6 units
▶	3ZY1 121-2BA00	1	6 units
▶	3ZY1 122-2BA00	1	6 units
▶	3ZY1 131-2BA00	1	6 units

Version	DT	Order No.	Price per PU	PU (UNIT, SET, M)	PS*
---------	----	-----------	--------------	-------------------	-----

Enclosure accessories



3ZY1 321-2AA00

Sealable covers

- 17.5 mm (for 3SK1 120 and 3SK1 220)
- 22.5 mm (for all 3SK1 devices other than 3SK1 120 and 3SK1 220)

▶	3ZY1 321-1AA00	1	5 units
▶	3ZY1 321-2AA00	1	5 units



3ZY 1311-0AA00

Push-in lugs for wall mounting

▶	3ZY1 311-0AA00	1	10 units
---	-----------------------	---	----------

Adapters and connection cables



3TK28 10-1A

Adapters

for connecting encoders of type Siemens/Heidenhain

- 15-pole

A	3TK28 10-1A	1	1 unit
---	--------------------	---	--------



3TK28 10-1B

- 25-pole

A	3TK28 10-1B	1	1 unit
---	--------------------	---	--------



3TK28 10-0A

Connection cables

for connecting the safety relay to the 3TK28 10-1A or 3TK28 10-1B adapter

C	3TK28 10-0A	1	1 unit
---	--------------------	---	--------

Blank inscription labels

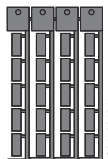

3RT29 00-1SB20

Unit labeling plates

for SIRIUS devices
20 mm x 7 mm, titanium gray

D	3RT29 00-1SB20	100	340 units
---	-----------------------	-----	-----------

Tools for opening spring-type terminals



3RA29 08-1A

Screwdrivers

for all SIRIUS devices with spring-type terminals;
3.0 mm x 0.5 mm; length approx. 200 mm; titanium gray/black, partially insulated

▶	3RA29 08-1A	1	1 unit
---	--------------------	---	--------

Spring-type terminals



Safety Relays

SIRIUS 3SK1

Technical Data

Application

SIRIUS 3SK1 safety relays are used mainly in autonomous safety applications which are not connected to a safety-oriented bus system. Their function here is to evaluate the sensors and the safety-oriented shutdown of hazards. Also they check and monitor the sensors, actuators and safety-oriented functions of the safety relay.

Technical specifications

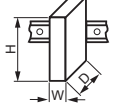
Type		3SK1 safety relays	
Dimensions		mm	22.5
• Width		mm	100
• Height		mm	120
• Depth			
General technical specifications			
Ambient temperature			
• During operation	°C		-25 ... +60
• During storage	°C		-40 ... +80
Installation altitude above sea level, maximum		m	2 000
Air pressure according to SN 31205		hPa	900 ... 1 060
Shock resistance			8 g / 11 ms
Vibration resistance according to IEC 60068-2-6			5 ... 500 Hz: 0.75 mm
IP degree of protection of the enclosure			IP20
Touch protection against electric shock			Finger-safe
Rated insulation voltage		V	300
Rated impulse withstand voltage		V	4 000
Safety integrity level (SIL) for time-delayed enabling circuit according to IEC 61508			SIL 3
Performance level (PL) for time-delayed enabling circuit according to ISO 13849-1			e
Electromagnetic compatibility (EMC) EMC emitted interference Certificate of suitability			IEC 60947-5-1, class B Available soon

Code conversion table

The table below lists the existing 3TK28 order numbers with the corresponding 3SK1 order numbers.

Order number 3TK28 basic units	Order number 3SK1 Standard basic units	Order number 3SK1 Advanced basic units	Order number 3TK28 basic units	Order number 3SK1 Standard basic units	Order number 3SK1 Advanced basic units
3TK28 20			3TK28 28		
3TK28 20-1AJ20	3SK1 111-1AW20	3SK1 121-1AB40 + 3SK1 230-1AW20	3TK28 28-1AB20	--	--
3TK28 20-1AL20	3SK1 111-1AW20	3SK1 121-1AB40 + 3SK1 230-1AW20	3TK28 28-1AB21	--	--
3TK28 20-1CB30	3SK1 111-1AB30	3SK1 121-1AB40	3TK28 28-1AJ20	--	3SK1 121-1CB42 + 3SK1 230-1AW20
3TK28 20-2AJ20	3SK1 111-2AW20	3SK1 121-2AB40 + 3SK1 230-2AW20	3TK28 28-1AJ21	--	3SK1 121-1CB41 + 3SK1 230-1AW20
3TK28 20-2AL20	3SK1 111-2AW20	3SK1 121-2AB40 + 3SK1 230-2AW20	3TK28 28-1AL20	--	3SK1 121-1CB42 + 3SK1 230-1AW20
3TK28 20-2CB30	3SK1 111-2AB30	3SK1 121-2AB40	3TK28 28-1AL21	--	3SK1 121-1CB41 + 3SK1 230-1AW20
3TK28 21			3TK28 28-1BB40	--	3SK1 121-1CB42 3SK1 121-1CB41
3TK28 21-1CB30	3SK1 111-1AB30	3SK1 121-1AB40	3TK28 28-1BB41	--	--
3TK28 21-2CB30	3SK1 111-2AB30	3SK1 121-2AB40	3TK28 28-2AB20	--	--
3TK28 22			3TK28 28-2AB21	--	--
3TK28 22-1CB30	3SK1 111-1AB30	3SK1 121-1AB40	3TK28 28-2AJ20	--	3SK1 121-2CB42 + 3SK1 230-2AW20
3TK28 22-2CB30	3SK1 111-2AB30	3SK1 121-2AB40	3TK28 28-2AJ21	--	3SK1 121-2CB41 + 3SK1 230-2AW20
3TK28 23			3TK28 28-2AL20	--	3SK1 121-2CB42 + 3SK1 230-2AW20
3TK28 23-1CB30	3SK1 111-1AB30	3SK1 121-1AB40	3TK28 28-2AL21	--	3SK1 121-2CB41 + 3SK1 230-2AW20
3TK28 23-2CB30	3SK1 111-2AB30	3SK1 121-2AB40	3TK28 28-2BB40	--	3SK1 121-2CB42
3TK28 24			3TK28 30		
3TK28 24-1AJ20	3SK1 111-1AW20	3SK1 121-1AB40 + 3SK1 230-1AW20	3TK28 30-1AJ20	3SK1 211-1BW20	3SK1 211-1BB40
3TK28 24-1AL20	3SK1 111-1AW20	3SK1 121-1AB40 + 3SK1 230-1AW20	3TK28 30-1AL20	3SK1 211-1BW20	3SK1 211-1BB40
3TK28 24-1BB40	3SK1 111-1AB30	3SK1 121-1AB40	3TK28 30-1CB30	3SK1 211-1BB40	3SK1 211-1BB40
3TK28 24-1CB30	3SK1 111-1AB30	3SK1 121-1AB40	3TK28 30-2AJ20	3SK1 211-2BW20	3SK1 211-2BB40
3TK28 24-2AJ20	3SK1 111-2AW20	3SK1 121-2AB40 + 3SK1 230-2AW20	3TK28 30-2AL20	3SK1 211-2BW20	3SK1 211-2BB40
3TK28 24-2AL20	3SK1 111-2AW20	3SK1 121-2AB40 + 3SK1 230-2AW20	3TK28 30-2CB30	3SK1 211-2BB40	3SK1 211-2BB40
3TK28 24-2BB40	3SK1 111-2AB30	3SK1 121-2AB40	3TK28 34		
3TK28 24-2CB30	3SK1 111-2AB30	3SK1 121-2AB40	3TK28 34-1AB20	--	--
3TK28 25			3TK28 34-1AJ20	--	3SK1 121-1AB40 + 3SK1 230-1AW20
3TK28 25-1AB20	3SK1 111-1AW20	3SK1 121-1AB40 + 3SK1 230-1AW20	3TK28 34-1AL20	--	3SK1 121-1AB40 + 3SK1 230-1AW20
3TK28 25-1AJ20	3SK1 111-1AW20	3SK1 121-1AB40 + 3SK1 230-1AW20	3TK28 34-1BB40	--	--
3TK28 25-1AL20	3SK1 111-1AW20	3SK1 121-1AB40 + 3SK1 230-1AW20	3TK28 34-2AB20	--	--
3TK28 25-1BB40	3SK1 111-1AB30	3SK1 121-1AB40	3TK28 34-2AJ20	--	3SK1 121-2AB40 + 3SK1 230-2AW20
3TK28 25-2AB20	3SK1 111-2AW20	3SK1 121-2AB40 + 3SK1 230-2AW20	3TK28 34-2AL20	--	3SK1 121-2AB40 + 3SK1 230-2AW20
3TK28 25-2AJ20	3SK1 111-2AW20	3SK1 121-2AB40 + 3SK1 230-2AW20	3TK28 34-2BB40	--	3SK1 121-2AB40
3TK28 25-2AL20	3SK1 111-2AW20	3SK1 121-2AB40 + 3SK1 230-2AW20	3TK28 40		
3TK28 25-2BB40	3SK1 111-2AB30	3SK1 121-2AB40	3TK28 40-1BB40	3SK1 112-1BB40	3SK1 122-1AB40
3TK28 27			3TK28 40-2BB40	3SK1 112-2BB40	3SK1 122-2AB40
3TK28 27-1AB20	--	--	3TK28 41		
3TK28 27-1AB21	--	--	3TK28 41-1BB40	3SK1 112-1BB40	3SK1 122-1AB40
3TK28 27-1AJ20	--	3SK1 121-1CB42 + 3SK1 230-1AW20	3TK28 41-2BB40	3SK1 112-2BB40	3SK1 122-2AB40
3TK28 27-1AJ21	--	3SK1 121-1CB41 + 3SK1 230-1AW20	3TK28 42		
3TK28 27-1AL20	--	3SK1 121-1CB42 + 3SK1 230-1AW20	3TK28 42-1BB41	--	3SK1 122-1CB41
3TK28 27-1AL21	--	3SK1 121-1CB41 + 3SK1 230-1AW20	3TK28 42-1BB42	--	3SK1 122-1CB42
3TK28 27-1BB40	--	3SK1 121-1CB42	3TK28 42-1BB44	--	3SK1 122-1CB44
3TK28 27-1BB41	--	3SK1 121-1CB41	3TK28 42-2BB41	--	3SK1 122-2CB41
3TK28 27-2AB20	--	--	3TK28 42-2BB42	--	3SK1 122-2CB42
3TK28 27-2AB21	--	--	3TK28 42-2BB44	--	3SK1 122-2CB44
3TK28 27-2AB20	--	3SK1 121-2CB42 + 3SK1 230-2AW20	3TK28 50		
3TK28 27-2AJ20	--	3SK1 121-2CB41 + 3SK1 230-2AW20	3TK28 50-1AJ20	3SK1 111-1AW20 + 3SK1 213-1AJ20	3SK1 120-1AB40 + 3SK1 213-1AB40
3TK28 27-2AJ21	--	3SK1 121-2CB41 + 3SK1 230-2AW20	3TK28 50-1AL20	3SK1 111-1AW20 + 3SK1 213-1AL20	3SK1 120-1AB40 + 3SK1 213-1AB40
3TK28 27-2AL20	--	3SK1 121-2CB42 + 3SK1 230-2AW20	3TK28 50-1BB40	3SK1 111-1AB30 + 3SK1 213-1AB40	3SK1 120-1AB40 + 3SK1 213-1AB40
3TK28 27-2AL21	--	3SK1 121-2CB41 + 3SK1 230-2AW20	3TK28 50-2AJ20	3SK1 111-2AW20 + 3SK1 213-2AJ20	3SK1 120-2AB40 + 3SK1 213-2AB40
3TK28 27-2BB40	--	3SK1 121-2CB42	3TK28 50-2AL20	3SK1 111-2AW20 + 3SK1 213-2AL20	3SK1 120-2AB40 + 3SK1 213-2AB40
3TK28 27-2BB41	--	3SK1 121-2CB41	3TK28 50-2BB40	3SK1 111-2AB30 + 3SK1 213-2AB40	3SK1 120-2AB40 + 3SK1 213-2AB40

Safety Relays

SIRIUS 3SK1

Cross reference

Order number 3TK28 basic units	Order number 3SK1 Standard basic units	Order number 3SK1 Advanced basic units
3TK28 51		
3TK28 51-1AJ20	3SK1 111-1AW20 + 3SK1 213-1AJ20	3SK1 120-1AB40 + 3SK1 213-1AB40
3TK28 51-1AL20	3SK1 111-1AW20 + 3SK1 213-1AL20	3SK1 120-1AB40 + 3SK1 213-1AB40
3TK28 51-1BB40	3SK1 111-1AB30 + 3SK1 213-1AB40	3SK1 120-1AB40 + 3SK1 213-1AB40
3TK28 51-2AJ20	3SK1 111-2AW20 + 3SK1 213-2AJ20	3SK1 120-2AB40 + 3SK1 213-2AB40
3TK28 51-2AL20	3SK1 111-2AW20 + 3SK1 213-2AL20	3SK1 120-2AB40 + 3SK1 213-2AB40
3TK28 51-2BB40	3SK1 111-2AB30 + 3SK1 213-2AB40	3SK1 120-2AB40 + 3SK1 213-2AB40
3TK28 52		
3TK28 52-1AL20	3SK1 111-1AW20 + 3SK1 213-1AL20	3SK1 120-1AB40 + 3SK1 213-1AB40
3TK28 52-1BB40	3SK1 111-1AB30 + 3SK1 213-1AB40	3SK1 120-1AB40 + 3SK1 213-1AB40
3TK28 52-2AL20	3SK1 111-2AW20 + 3SK1 213-2AL20	3SK1 120-2AB40 + 3SK1 213-2AB40
3TK28 52-2BB40	3SK1 111-2AB30 + 3SK1 213-2AB40	3SK1 120-2AB40 + 3SK1 213-2AB40

Order number 3TK28 basic units	Order number 3SK1 Standard basic units	Order number 3SK1 Advanced basic units
3TK28 53		
3TK28 53-1BB40	3SK1 111-1AB30 + 3SK1 213-1AB40	3SK1 120-1AB40 + 3SK1 213-1AB40
3TK28 53-2BB40	3SK1 111-2AB30 + 3SK1 213-2AB40	3SK1 120-2AB40 + 3SK1 213-2AB40
3TK28 56		
3TK28 56-1BB40	3SK1 213-1AB40	3SK1 213-1AB40
3TK28 56-2BB40	3SK1 213-2AB40	3SK1 213-2AB40
3TK28 57		
3TK28 57-1BB41	--	3SK1 213-1AB40 (delay as for basic unit)
3TK28 57-1BB42	--	3SK1 213-1AB40 (delay as for basic unit)
3TK28 57-1BB44	--	3SK1 213-1AB40 (delay as for basic unit)
3TK28 57-2BB41	--	3SK1 213-2AB40 (delay as for basic unit)
3TK28 57-2BB42	--	3SK1 213-2AB40 (delay as for basic unit)
3TK28 57-2BB44	--	3SK1 213-2AB40 (delay as for basic unit)

Overview

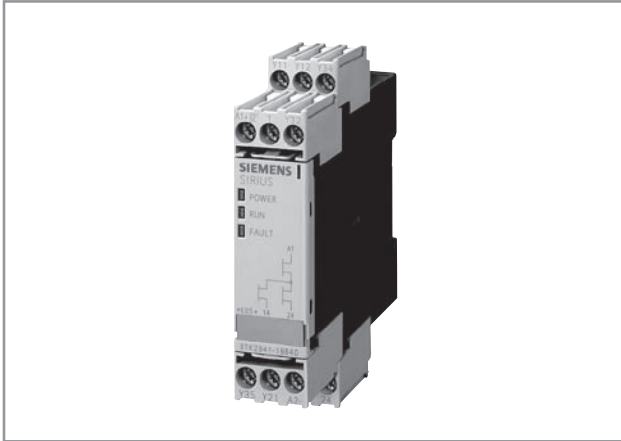

SIRIUS 3TK28 safety relay

SIRIUS safety relays are the key modules of a consistent and cost-effective safety chain. Be it EMERGENCY-STOP disconnection, protective door monitoring or the protection of presses or punches – with SIRIUS safety relays every safety application can be implemented to optimum effect in terms of engineering and price.

SIRIUS safety relays provide numerous safety-related functions:

- Monitoring the safety functions of sensors
- Monitoring the sensor leads
- Monitoring the correct operation of the safety relay
- Monitoring actuators for standstill
- Safety-oriented disconnection when dangers arise

Depending on the version of the device, SIRIUS safety relays satisfy the most stringent requirements (PL e) according to ISO 13849-1 and achieve the highest Safety Integrity Level (SIL 3) acc. to IEC 61508.

3TK28 Safety Relays

With relay enabling circuits

Basic units

3TK28 26

[See page 13/134](#)

Basic units T_v

3TK28 26

With electronic enabling circuits

Multifunction units

3TK28 45

[See page 13/134](#)

With special functions

Standstill monitors

3TK28 10-0

[See page 13/134](#)

Overspeed monitors

3TK28 10-1

Benefits

General

- Can be used for all safety applications thanks to compliance with the highest safety requirements (PL e according to ISO 13849-1 or SIL 3 according to IEC 61508)
- Suitable for use all over the world through compliance with all globally established certifications
- Compact, service-proven SIRIUS design creates more space in the control cabinet
- Flexible connectability and expandability make subsequent changes easy
- Removable terminal for greater plant availability
- Yellow front plate clearly identifies the device as an item of safety technology
- Sensor cable up to 2000 m long enables use in large-scale plants

Relay outputs

- Different voltages can be switched through the floating contacts
- Higher currents can be switched with relay contacts

Solid-state outputs

- Wear-free
- Suitable for operation in fast switching applications
- Insensitive to vibrations and dirt
- Good electrical endurance

Microprocessor systems

- Flexible use thanks to many different integrated functions
- Easy parameterization using DIP switches on the front
- High functional reliability based on extensive monitoring functions
- Operated by the machine control system
- Also connection of non-contact sensors (light arrays, light barriers etc.)

Application

SIRIUS safety relays are used mainly in autonomous safety applications which are not connected to a safety-oriented bus system.

Their function here is to evaluate the sensors and the safety-oriented shutdown of hazards. Also they check and monitor the sensors, actuators and safety-oriented functions of the safety relay.

Safety Relays

SIRIUS 3TK28

General data

Overview



SIRIUS 3TK28 2. safety relay

Safety relays with relay enabling circuits – safety with floating contacts

SIRIUS safety relays with relay enabling circuits not only save a great deal of space thanks to their compact design but also offer extra safety in the form of positively driven pairs of make and break contacts. If one of the contacts becomes welded, the other will disconnect the circuit. A positively driven break contact (NC) then performs the fault detection of the faulty make contact (NO).

3TK28 26 safety relays

The 3TK28 26 is a parameterizable safety relay. It is used as an evaluation unit for typical safety chains (detection, evaluation, disconnection). DIP switches on the front can be used to set many different functions. The 3TK28 26 is therefore universally applicable.

Safety sensors (e.g. EMERGENCY-STOP pushbuttons) are connected at the input side while contactors or valves for disconnecting the "hazardous function" are connected at the output side. The 3TK28 26 performs the monitoring of the sensor and actuator functions as well as the safe disconnection of the outputs (enabling circuits).

3TK28 26 with DIP switch:

OFF	Schematic	DIP switch No.	ON
Without crossover monitoring		1	Switching mat operation
NC/NO evaluation:		2	NC/NC contact evaluation
2 x 1-channel		3	1 x 2-channel
Debounce time for sensor inputs 50 ms		4	Debounce time for sensor inputs 10 ms
Sensor input autostart		5	Sensor input monitored start
Cascading input autostart		6	Cascading input monitored start
With start test		7	Without start test
Automatic start after mains failure (not permitted in connection with a start test)		8	Without automatic start after mains failure

Benefits

3TK28 26 safety relays

- Compact design
- Connection of all standard sensor types
- Many functions available in a single unit
- Status indications
- Expanded diagnostics options
- Approvals (EN 13849-1, IEC 61508, UL/CSA)
- Signaling of disconnect faults in the actuator circuit
- Floating outputs
- Units with wide voltage range
- Saving of the sensor status in the event of voltage failure
- Can be used up to an ambient temperature of max. 70 °C

Overview

3TK28 45 multi-function units

Evaluation units with solid-state components are being used increasingly in safety applications because their permanent checking of functions and largely wear-free operation results in a far higher switching frequency and electrical endurance of equipment. The compact and lightweight units also permit series connection or normal switching duty, e.g. by a PLC.

Up to now, standard combinations of safety applications such as EMERGENCY-STOP and protective door monitoring were possible only by using several individual safety relays. 3TK28 45 combines several functions in a single unit. Two solid-state and two relay enabling circuits ensure safe disconnection – in just a few actions, quickly and cheaply.

Benefits

3TK28 45 safety relays

- 2 sensor inputs (e.g. EMERGENCY-STOP, protective door)
- Also suitable for protective door interlocking and OK buttons
- 2 solid-state enabling circuits and 2 relay enabling circuits
- Permanent function checking
- No wear because switched electronically
- High switching frequency
- Long electrical endurance
- Evaluation of solid-state sensors
- Sensor lead up to max. 2 000 m
- Cascading possible
- Insensitive to vibrations and dirt
- Compact design, low weight

Overview

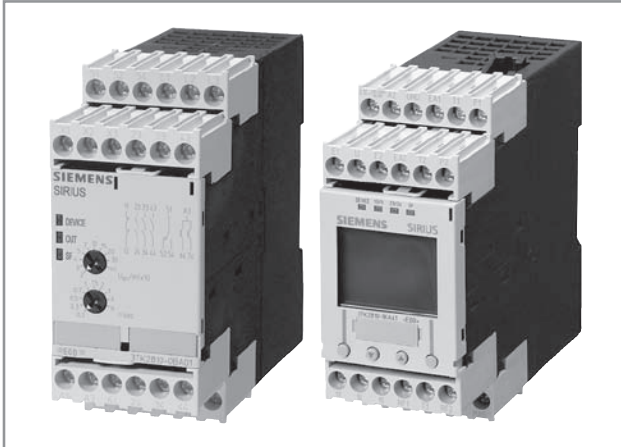

SIRIUS 3TK28 10 safety relays

3TK28 10-0 standstill monitor

The standstill monitor increases safety in hazardous areas. Without a sensor, it detects motor stoppage from the residual magnetization of the rotating motor. When an adjustable threshold value is undershot, it uses its outputs to allow access to hazardous areas for example by unlocking a protective door.

3TK28 10-1 overspeed monitors

The overspeed monitor combines two safety functions in one unit by continuously monitoring machines and plants for standstill and speed.

Through simple parameterization and permanent diagnosis on the display, faults can be quickly remedied at any time – often before they cause plant downtimes.

In addition to standstill and speed monitoring the unit also features integrated monitoring of a protective door with spring-type interlocking. An additional evaluation unit is not needed therefore.

Benefits

3TK28 10-0 standstill monitor

- No additional sensors required
- Signaling of faults with diagnostics display
- Standstill time can be set
- Unit can be used with frequency converters

3TK28 10-1 overspeed monitors

- Menu-prompted, easy parameterization
- Direct diagnosis on the display means shorter downtimes thanks to early fault detection
- Integrated protective door monitoring means greater safety because access to the plant is allowed only in the safe state
- Suitable for all standard sensors, i.e. high flexibility

Safety Relays

SIRIUS 3TK28

General data

Type	Basic units				Standstill monitors 3TK28 10-0	Overspeed monitors 3TK28 10-1
	3TK28 26 24 V DC	Wide voltage range	24 V DC t_V	Wide voltage range t_V		
Sensors						
• Inputs	1	1	1	1	3	4
• Electronic	✓	--	✓	--	--	3
• With contacts	✓	✓	✓	✓	--	1
• Without sensors (measuring inputs)	--	--	--	--	3	--
• Magnetically operated switch (Reed contacts)	✓	✓	✓	✓	--	--
Safety mats	✓	✓	✓	✓	--	--
Start						
• Auto	✓	✓	✓	✓	✓	✓
• Monitored	✓	✓	✓	✓	--	✓
Cascading input 24 V DC	✓	✓	✓	✓	--	--
Key-operated switch	--	--	--	--	--	--
Enabling circuit, floating						
• Stop category 0	4 NO	4 NO	2 NO	2 NO	3 NO + 1 NC	2
• Stop category 1	--	--	2 NO	2 NO	--	--
Enabling circuit, solid-state						
• Stop category 0	--	--	--	--	--	--
• Stop category 1	--	--	--	--	--	--
Signaling outputs						
• Floating	1 NC	1 NO + 1 NC	2 NC	1 NO + 2 NC	1 CO	--
• Electronic	2	--	2	--	2	2
Standards	EN 60204-1, EN ISO 12100, EN 954-1, IEC 61508	EN 60204-1, EN ISO 12100, EN 954-1, IEC 61508	EN 60204-1, EN ISO 12100, EN 954-1, IEC 61508	EN 60204-1, EN ISO 12100, EN 954-1, IEC 61508	EN 60204-1, EN ISO 12100, EN 954-1, IEC 61508	IEC 60947-5-1, EN ISO 13849-1, EN 60204-1, IEC 61508
Compliance to standards	TÜV, UL, CSA	TÜV, UL, CSA	TÜV, UL, CSA	TÜV, UL, CSA	TÜV, UL, CSA	TÜV
Category according to EN 954-1 max	4	4	4	4	4	4
SIL level max. according to IEC 61508	3	3	3	3	3	3
Performance level PL according to ISO 13849-1	e	e	e	e	e	e
Probability of a dangerous failure per hour (PFH_d)	7.8×10^{-9} 1/h	7.8×10^{-9} 1/h	7.8×10^{-9} 1/h	7.8×10^{-9} 1/h	1.5×10^{-8} 1/h	3.38×10^{-9} 1/h
Rated control supply voltage						
• 24 V DC	✓	--	✓	--	✓	✓
• 24 V AC/DC	--	--	--	--	--	--
• 24 V AC	--	--	--	--	--	--
• 115 V AC	--	--	--	--	--	--
• 230 V AC	--	--	--	--	✓	--
• 400 V AC	--	--	--	--	✓	--
• 24 ... 240 V AC/DC	--	✓	--	✓	--	✓

✓ Available

-- Not available

1) Only possible for instantaneous enabling contacts, otherwise Category 3.

2) For expansion of Siemens safety products.

3) Only possible for instantaneous enabling contacts, otherwise SIL 2 or Performance Level PL d.

Selection and ordering data

Type	Multi-function units 3TK28 45							
	"Automatic and monitored start"	"Automatic and monitored start" t_v	"Monitored start"	"Monitored start" t_v	OK button	OK button t_v	"Spring-type interlocking" t_v	"Magnet-locked interlocking" t_v
Sensors								
• Inputs	2	2	2	2	2	2	2	2
• Electronic	✓	✓	✓	✓	✓	✓	✓	✓
• With contacts	✓	✓	✓	✓	✓	✓	✓	✓
• Magnetically operated switch (Reed contacts)	✓	✓	✓	✓	✓	✓	✓	✓
Safety mats	✓	✓	✓	✓	--	--	--	--
Start								
• Auto	1	1	--	--	1	1	--	--
• Monitored	1	1	2	2	1	1	2	2
Cascading input 24 V DC	✓	✓	✓	✓	✓	✓	✓	✓
Key-operated switch	✓	✓	✓	✓	✓	✓	✓	✓
Enabling circuit, floating								
• Stop category 0	2 NO	1 NO	2 NO	1 NO	2 NO	1 NO	1 NO	1 NO
• Stop category 1	--	1 NO	--	1 NO	--	1 NO	1 NO	1 NO
Enabling circuit, solid-state								
• Stop category 0	2	1	2	1	2	1	1	1
• Stop category 1	--	1	--	1	--	1	1	1
Signaling outputs								
• Floating	--	--	--	--	--	--	--	--
• Electronic	1	1	1	1	1	1	1	1
Standards	EN 60204-1, EN ISO 12100, EN 954-1, IEC 61508							
Test certificates								
Category according to EN 954-1 max	4	4	4	4	4	4	4	4
SIL level max. according to IEC 61508	3	3	3	3	3	3	3	3
Performance level PL according to ISO 13849-1	e	e	e	e	e	e	e	e
Probability of a dangerous failure per hour (PFH_d)	6.9×10^{-9} 1/h	6.9×10^{-9} 1/h	6.9×10^{-9} 1/h	6.9×10^{-9} 1/h	6.9×10^{-9} 1/h	6.9×10^{-9} 1/h	6.9×10^{-9} 1/h	6.9×10^{-9} 1/h
Rated control supply voltage 24 V DC	✓	✓	✓	✓	✓	✓	✓	✓

✓ Available
-- Not available

¹⁾ The outputs are only safe when an external contactor is used.

Safety Relays

SIRIUS 3TK28

Safety relays

PU (UNIT, SET, M) = 1
 PS* = 1 unit
 PG = 41L



3TK28 26-2BB4



3TK28 45-1HB40



3TK28 45-1HB41



3TK28 45-2DB40



3TK28 10-0BA01



3TK28 10-1BA41

Rated control supply voltage U_s	Start	OFF-delay t_v	DT	Screw terminals	DT	Spring-type terminals
V		s		Order No.	Price per PU	Order No. Price per PU

Basic units

With floating enabling circuits

3TK28 26

• 24 DC	Auto/monitored	--		3TK28 26-1BB40	A	3TK28 26-2BB40
• 24 ... 240 AC/DC	Auto/monitored	--		3TK28 26-1CW30	A	3TK28 26-2CW30

With time-delay enabling circuits

3TK28 26 t_v

• 24 DC	Auto/monitored	0.05 ... 3	A	3TK28 26-1BB41	A	3TK28 26-2BB41
• 24 ... 240 AC/DC	Auto/monitored	0.05 ... 3	A	3TK28 26-1CW31	A	3TK28 26-2CW31
• 24 DC	Auto/monitored	0.5 ... 30	A	3TK28 26-1BB42	A	3TK28 26-2BB42
• 24 ... 240 AC/DC	Auto/monitored	0.5 ... 30	A	3TK28 26-1CW32	A	3TK28 26-2CW32
• 24 DC	Auto/monitored	5 ... 300	A	3TK28 26-1BB44	A	3TK28 26-2BB44
• 24 ... 240 AC/DC	Auto/monitored	5 ... 300	A	3TK28 26-1CW34	A	3TK28 26-2CW34

Multi-function units with electronic enabling circuits

3TK28 45 "Automatic and monitored start"

• 24 DC	1/1	--	A	3TK28 45-1HB40	B	3TK28 45-2HB40
---------	-----	----	---	----------------	---	----------------

3TK28 45 t_v "Automatic and monitored start"

• 24 DC	1/1	0.05 ... 3	A	3TK28 45-1HB41	B	3TK28 45-2HB41
	1/1	0.5 ... 30	A	3TK28 45-1HB42	B	3TK28 45-2HB42
	1/1	5 ... 300	A	3TK28 45-1HB44	B	3TK28 45-2HB44

3TK28 45 "Monitored start"

• 24 DC	--/2	--	A	3TK28 45-1DB40	B	3TK28 45-2DB40
---------	------	----	---	----------------	---	----------------

3TK28 45 t_v "Monitored start"

• 24 DC	--/2	0.05 ... 3	A	3TK28 45-1DB41	B	3TK28 45-2DB41
	--/2	0.5 ... 30	A	3TK28 45-1DB42	B	3TK28 45-2DB42
	--/2	5 ... 300	C	3TK28 45-1DB44	B	3TK28 45-2DB44

3TK28 45 "OK button"

• 24 DC	1/1	--	A	3TK28 45-1EB40	B	3TK28 45-2EB40
---------	-----	----	---	----------------	---	----------------

3TK28 45 t_v "OK button"

• 24 DC	1/1	0.05 ... 3	A	3TK28 45-1EB41	B	3TK28 45-2EB41
	1/1	0.5 ... 30	A	3TK28 45-1EB42	B	3TK28 45-2EB42

3TK28 45 t_v "Spring-type interlocking"

• 24 DC	--/2	0.05 ... 3	A	3TK28 45-1FB41	B	3TK28 45-2FB41
	--/2	0.5 ... 30	A	3TK28 45-1FB42	B	3TK28 45-2FB42
	--/2	5 ... 300	B	3TK28 45-1FB44	B	3TK28 45-2FB44

3TK28 45 t_v "Solenoid interlocking"

• 24 DC	--/2	0.05 ... 3	A	3TK28 45-1GB41	B	3TK28 45-2GB41
	--/2	0.5 ... 30	A	3TK28 45-1GB42	B	3TK28 45-2GB42
	--/2	5 ... 300	C	3TK28 45-1GB44	B	3TK28 45-2GB44

Standstill monitors

3TK28 10-0

• 24 DC		0.2... 6	A	3TK28 10-0BA01	A	3TK28 10-0BA02
• 230 AC		0.2... 6	A	3TK28 10-0GA01	A	3TK28 10-0GA02
• 400 AC		0.2... 6	A	3TK28 10-0JA01	B	3TK28 10-0JA02

Overspeed monitors







3TK28 10-1 for NPN/PNP proximity switches and encoders

• 24 DC		0 ... 600	A	3TK28 10-1BA41	A	3TK28 10-1BA42
• 120 ... 240 AC/DC		0 ... 600	A	3TK28 10-1KA41	A	3TK28 10-1KA42

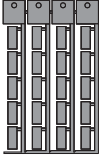
3TK28 10-1 for NAMUR proximity switches and encoders

• 24 DC		0 ... 600	A	3TK28 10-1BA41-0AA0	A	3TK28 10-1BA42-0AA0
• 120 ... 240 AC/DC		0 ... 600	A	3TK28 10-1KA41-0AA0	A	3TK28 10-1KA42-0AA0

Accessories



Use	Version	DT	Order No.	Price per PU	PU (UNIT, SET, M)	PS*	PG
Blank labels							
 3RT19 00-1SB20	For 3TK28		Unit labeling plates for SIRIUS devices 20 mm x 7 mm, pastel turquoise	▶	3RT19 00-1SB20	100	340 units 41B
	For 3TK28		Inscription labels for sticking for SIRIUS devices				
			<ul style="list-style-type: none"> • 19 mm x 6 mm, pastel turquoise • 19 mm x 6 mm zinc yellow 	C	3RT19 00-1SB60	100	3 060 units 41B
				C	3RT19 00-1SD60	100	3 060 units 41B
Push-in lugs and covers							
 3RP19 03	For 3TK28		Push-in lugs For screw fixing, 2 units are required for each device	▶	3RP19 03	1	10 units 41H
 3RP19 02	For 3TK28 26		Sealable covers for securing against unauthorized adjustment of setting knobs	B	3TK28 26-0DA00-0HA0	1	5 units 41L
Adapters and connection cables for overspeed monitors							
 3TK28 10-1A	For 3TK28 10-1		Adapters for connecting encoders of type Siemens/Heidenhain				
			<ul style="list-style-type: none"> • 15-pole 	A	3TK28 10-1A	1	1 unit 41L
 3TK28 10-1B			<ul style="list-style-type: none"> • 25-pole 	A	3TK28 10-1B	1	1 unit 41L
 3TK28 10-0A	For 3TK28 10-1		Connection cables for connecting the overspeed monitor to the 3TK28 10-1A or 3TK28 10-1B adapter	A	3TK28 10-0A	1	1 unit 41L
Tools for opening spring-type terminals							
 3RA29 08-1A	For auxiliary circuit connections		Screwdrivers For all SIRIUS devices with spring-type terminals 3.0 mm x 0.5 mm, length approx. 200 mm, titanium gray/black, partially insulated	▶	3RA29 08-1A	1	1 unit 41B
					Spring-type terminals		

Safety Relays

SIRIUS 3TK28

3TK2826 with relay enabling circuits

Technical specifications

Type		3TK28 26-.BB40	3TK28 26-.CW30	3TK28 26-.BB41 3TK28 26-.BB42 3TK28 26-.BB44	3TK28 26-.CW31 3TK28 26-.CW32 3TK28 26-.CW44
General data					
Standards		EN 60204-1, EN ISO 12100, EN 954-1, IEC 61508			
Test certificates		TÜV, UL, CSA			
Safety-oriented output contacts					
• Instantaneous FK_{rel}		4		2	
• Time-delayed $FK_{rel(t)}$		--		2	
Safety-oriented semiconductor outputs					
• Instantaneous FK_{el}		--			
• Time-delay $FK_{el(t)}$		--			
Signaling contacts MK_{rel}		1	2		3
Semiconductor signaling outputs MK_{rel}		2	--	2	--
Sensor inputs S		1			
Cascading inputs KAS/BS		1			
Degree of protection acc. to EN 60529		IP40 IP20			
• Enclosure					
• Terminals					
Shock resistance sine wave	<i>g</i> /ms	8/10			
Permissible mounting positions		Any			
Touch protection acc. to EN 61140 or EN 60900		Finger-safe			
Height	mm	106: screw terminals; 108: spring-type terminals			
Width	mm	45			
Depth	mm	116			
Weight	kg	0.350			
Connection type		 Screw terminals			
• Terminal screw		M 3 (standard screwdriver, size 2 and Pozidriv 2)			
• Solid	mm ²	1 x (0.5 ... 4)/2 x (0.5 ... 2.5)			
• Finely stranded with end sleeve	mm ²	1 x (0.5 ... 2.5)/2 x (0.5 ... 1.5)			
• AWG cables, solid or stranded	AWG	2 x (24 ... 16)			
• Tightening torque	Nm	0.8 ... 1.2			
Connection type		 Spring-type terminals			
• Solid	mm ²	2 x (0.25 ... 1.5)			
• Finely stranded, with end sleeves acc. to DIN 4622	mm ²	2 x (0.25 ... 1.0)			
• Finely stranded	mm ²	2 x (0.25 ... 1.5)			
• Stripped length	mm	10			
Electrical specifications					
Rated control supply voltage U_s	V	24 DC	24 ... 240 AC/DC	24 DC	24 ... 240 AC/DC
Operating range					
• AC operation	V	--	0.9 ... 1.1 x U_s	--	0.9 ... 1.1 x U_s
• DC operation	V	0.85 ... 1.2 x U_s	0.9 ... 1.1 x U_s	0.85 ... 1.2 x U_s	0.9 ... 1.1 x U_s
Measurement voltage	V	--			
Response value U_{resp}	mV	--			
Rated insulation voltage U_i					
• For control circuit	V	--			
• For outputs	V	300			
Rated impulse withstand voltage U_{imp}					
• For control circuit	V	--			
• For outputs	V	4000			
Rated power	W	3			
Frequency ranges	Hz	50/60			
Rated operational current I_e (relay outputs) at					
• AC-15 at 115 V	A	13/14, 23/24, 33/34, 43/44: 4 51/52: 3	13/14, 23/24, 33/34, 43/44: 4 51/52: 3	13/14, 23/24, 33/34, 43/44: 4 51/52: 3	13/14, 23/24, 33/34, 43/44: 4 51/52: 3
• AC-15 at 230 V	A	13/14, 23/24, 33/34, 43/44: 4 51/52: 3	13/14, 23/24, 33/34, 43/44: 4 51/52: 3	13/14, 23/24, 47/48, 57/58: 4 31/32, 61/62: 3	13/14, 23/24, 33/34, 43/44: 4 51/52: 3
• DC-13 at 24 V	A	13/14, 23/24, 33/34, 43/44: 4 51/52: 2	13/14, 23/24, 33/34, 43/44: 4 51/52: 2, 63/64: 1	13/14, 23/24, 47/48, 57/58: 4 31/32, 61/62: 2	13/14, 23/24, 47/48, 57/58: 4 31/32, 61/62: 2 73/74: 1
• DC-13 at 115 V	A	0.2	0.2	0.2	0.2
• DC-13 at 230 V	A	0.1	0.1	0.1	0.1
Rated operational current I_e (semiconductor outputs) at					
• DC-13 at 24 V	A	64, 75: 0.5	--	74, 84: 0.5	--
• DC-13 at 230 V	A	--	--	--	--

3TK2826 with relay enabling circuits

1
2
3
4
5
6
7
8
9
10
11
12
13

Type		3TK28 26-.BB40	3TK28 26-.CW30	3TK28 26-.BB41 3TK28 26-.BB42 3TK28 26-.BB44	3TK28 26-.CW31 3TK28 26-.CW32 3TK28 26-.CW44
Electrical specifications (continued)					
Electrical endurance	Oper. cycles	--			
Mechanical endurance	Oper. cycles	10 ⁷			
Switching frequency z	1/h	2000			
Conventional thermal current I_{th}	A	Summation current max. 12			
Conventional thermal current I_{th}					
• 1 contact	A	4			
• 2 contacts	A	4			
• 3 contacts	A	4			
• 4 contacts	A	3			
Fusing for output contacts					
Fuse links LV HRC Type 3NA, DIAZED Type 5SB, NEOZED Type 5SE, gL/gG operational class					
• gL/gG	A	4			
• Quick	A	6			
Maximum line resistance	Ω	1000			
Cable length from terminal to terminal	m	2000			
With Cu 1.5 mm ² and 150 nF/km					
Times					
Bridging of voltage dips, supply voltage	ms	Min. 10			
(only internal, no outputs)					
Make-time t_E					
• For automatic start typ.	ms	50 + debounce time			
• For automatic start max.	ms	50 + debounce time			
• For automatic start after mains failure typ	ms	Approx. 8000 starting time			
• For automatic start after mains failure max	ms	Approx. 8000 starting time			
• For monitored start typ.	ms	50 + debounce time			
• For monitored start max.	ms	50 + debounce time			
Release time t_R					
• For sensor typ.	ms	50 + deb. time	50 + deb. time	--	--
• For sensor max.	ms	--	--	50+ deb. time	50+ deb. time
• For mains failure typ.	ms	75	--	75	--
• For mains failure max.	ms	125	300	125	320
Recovery time t_W					
• After sensor	ms	Min. 250		Min. 250	Min. 250
• After mains failure	s	Min. 200		Min. 600	Min. 200
Minimum command duration t_B					
• Sensor input	ms	30			
• ON button	s	0.2 ... 5			
• Cascading input	s	--			
Simultaneity t_G	ms	∞			
Temperatures					
Permissible ambient temperature					
• During operation	°C	-25 ... +60			
• During storage	°C	-40 ... +80			
Safety specifications					
Safety integrity level SIL CL		3			
acc. to IEC 61508					
Performance level PL		e			
acc. to ISO 13849-1					
Safety category CAT		4			
acc. to EN 954-1					
Type		acc. to EN 574			
Probability of a dangerous failure					
• Per hour (PFH _D)	1/h	7.8 x 10 ⁻⁹	7.8 x 10 ⁻⁹	7.8 x 10 ⁻⁹	7.8 x 10 ⁻⁹
• On demand (PFD)		--	--	--	--
Proof-test interval T1	a	20			
Environmental data					
EMC		EN 60947-5-1			
Vibrations		acc. to EN 60068-2-6			
• Frequency	Hz	5 ... 500			
• Amplitude	mm	0.075			
Climatic withstand capability		EN 60068-2-1, EN 60068-2-2, EN 60068-2-14, EN 60068-2-30			
Clearances in air and creepage distances		EN 60947-1			

¹⁾ Time-delayed enabling circuit: ≤ 300 ms adjustable.

Safety Relays

SIRIUS 3TK28

3TK2845 with electronic enabling circuits

Technical specifications

Type		3TK28 45...B40	3TK28 45...B41 3TK28 45...B42 3TK28 45...B44
General data			
Standards		EN 60204-1, EN ISO 12100, EN 954-1, IEC 61508	
Test certificates		TÜV, UL, CSA	
Safety-oriented output contacts			
• Instantaneous FK_{rel}		2	1
• Time-delayed $FK_{rel}(tv)$		--	1
Safety-oriented semiconductor outputs			
• Instantaneous FK_{el}		2	1
• Time-delay $FK_{el}(tv)$		--	1
Signaling contacts MK_{rel}			
Semiconductor signaling outputs MK_{rel}		1	
Sensor inputs S		2	
Cascading inputs KAS/BS		1	
Degree of protection acc. to EN 60529		IP40 IP20	
• Enclosure			
• Terminals			
Shock resistance sine wave	g/ms	8/10 and 15/5	
Permissible mounting positions		Any	
Touch protection acc. to EN 61140 or EN 60900		Finger-safe	
Height	mm	102: Screw terminals; 104: Spring-type terminals	
Width	mm	45	
Depth	mm	120	
Weight	kg	0.400	
Connection type		⊕ Screw terminals	
• Terminal screw		M 3 (standard screwdriver, size 2 and Pozidriv 2)	
• Solid	mm ²	1 x (0.5 ... 4)/2 x (0.5 ... 2.5)	
• Finely stranded with end sleeve	mm ²	1 x (0.5 ... 2.5)/2 x (0.5 ... 1.5)	
• AWG cables, solid or stranded	AWG	2 x (24 ... 16)	
• Tightening torque	Nm	0.8 ... 1.2	
Connection type		∞ Spring-type terminals	
• Solid	mm ²	2 x (0.25 ... 1.5)	
• Finely stranded, with end sleeves acc. to DIN 46228	mm ²	2 x (0.25 ... 1.5)	
• Finely stranded	mm ²	2 x (0.25 ... 1.5)	
Electrical specifications			
Rated control supply voltage U_s	V	24 DC	
Operating range DC operation	V	0.85 ... 1.15 × U_s	
Rated insulation voltage U_i			
• For control circuit	V	50	
• For outputs	V	50/300	
Rated impulse withstand voltage U_{imp}			
• For control circuit	V	500	
• For outputs	V	500/4000	
Rated power at U_s	W	2.5	
Frequency ranges	Hz	--	
Rated operational current I_e (relay outputs) at			
• AC-15 at 115 V	A	--	
• AC-15 at 230 V	A	3	
• DC-13 at 24 V	A	1	
• DC-13 at 115 V	A	--	
• DC-13 at 230 V	A	0.1	
Rated operational current I_e (semiconductor outputs) at			
• DC-13 at 115 V	A	0.5	
• DC-13 at 230 V	A	--	
Electrical endurance	Operat- ing cycles	Unlimited	
Mechanical endurance	Operat- ing cycles	10 ⁵	
Switching frequency z	1/h	2000	

Technical specifications



Type		3TK28 45-..B40	3TK28 45-..B41 3TK28 45-..B42 3TK28 45-..B44
Electrical specifications (continued)			
Conventional thermal current I_{th}		--	
Conventional thermal current I_{th}			
• 1 contact	A	--	
• 2 contacts	A	--	
• 3 contacts	A	--	
• 4 contacts	A	--	
Fusing for output contacts			
Fuse links LV HRC Type 3NA, DIAZED Type 5SB, NEOZED Type 5SE, gL/gG operational class			
• gL/gG		Not required	
• Quick		Not required	
Maximum line resistance	Ω	1000	
Cable length from terminal to terminal	m	1000	
With Cu 1.5 mm ² and 150 nF/km			
Times			
Bridging of voltage dips, supply voltage (only internal, no outputs)	ms	25	
Make-time t_E			
• For automatic start typ.	ms	60	
• For automatic start max.	ms	100	
• For automatic start after mains failure typ.	ms	--	
• For automatic start after mains failure max.	ms	--	
• For monitored start typ.	ms	60	
• For monitored start max.	ms	100	
Release time t_R			
• For sensor typ.	ms	45	--
• For sensor max.	ms	--	0.05 ... 300
			Adjustable
• For mains failure typ.	ms	25	25
• For mains failure max.	ms	30	30
Recovery time t_W			
• After sensor	ms	400	
• After mains failure	s	Max. 8	
Minimum command duration t_G			
• Sensor input	ms	45	
• ON button input	ms	200 ... 5000	
• Cascading input	ms	45	
Simultaneity t_G	ms	∞	
Temperatures			
Permissible ambient temperature			
• During operation	°C	-25 ... +60	
• During storage	°C	-40 ... +80	
Safety specifications			
Safety integrity level SIL CL		3	
acc. to IEC 61508			
Performance level PL		e	
acc. to ISO 13849-1			
Safety category CAT		4	
acc. to EN 954-1			
Type			
acc. to EN 574			
Probability of a dangerous failure			
• Per hour (PFH _D)	1/h	6.86 x 10 ⁻⁹	
• On demand (PFD)		--	
Proof-test interval T1	a	20	
Environmental data			
EMC			
			IEC 60947-5-1, IEC 60000-4-3, IEC 60000-4-5, IEC 60000-4-6
Vibrations			
acc. to EN 60068-2-6			
• Frequency	Hz	5 ... 500	
• Amplitude	mm	0.075	
Climatic withstand capability		EN 60068-2-78	
Clearances in air and creepage distances		EN 60947-1	

Safety Relays

SIRIUS 3TK28

3TK2810 with special functions

Technical specifications

Type		3TK28 10
General data		
Standards	EN 60204-1, EN ISO 12100, EN 954-1, IEC 61508	
Test certificates	TÜV, UL, CSA	
Safety-oriented output contacts	<ul style="list-style-type: none"> Instantaneous FK_{rel} Time-delayed $FK_{rel(tv)}$ 	
Safety-oriented semiconductor outputs	<ul style="list-style-type: none"> Instantaneous FK_{el} Time-delay $FK_{el(tv)}$ 	
Signaling contacts MK_{rel}	1	
Semiconductor signaling outputs MK_{rel}	2	
Sensor inputs S	1	
Cascading inputs KAS/BS	--	
Degree of protection acc. to EN 60529	IP40	
<ul style="list-style-type: none"> Enclosure Terminals 	IP20	
Shock resistance sine wave	g/ms	8/10
Permissible mounting positions	Any	
Touch protection acc. to EN 61140 or EN 60900	Finger-safe	
Height	mm	106: screw terminals; 108: spring-type terminals
Width	mm	45
Depth	mm	116
Weight	kg	0.500
Connection type	 Screw terminals	
<ul style="list-style-type: none"> Terminal screw Solid Finely stranded with end sleeve AWG cables, solid or stranded Tightening torque 	mm ² mm ² AWG Nm	M 3 (standard screwdriver, size 2 and Pozidriv 2) 1 x (0.5 ... 4)/2 x (0.5 ... 2.5) 1 x (0.5 ... 2.5)/2 x (0.5 ... 1.5) 2 x (24 ... 16) 0.8 ... 1.2
Connection type	 Spring-type terminals	
<ul style="list-style-type: none"> Solid Finely stranded, with end sleeves acc. to DIN 46228 Finely stranded 	mm ² mm ² mm ²	2 x (0.25 ... 1.5) 2 x (0.25 ... 1.0) 2 x (0.25 ... 1.5)
Electrical specifications		
Rated control supply voltage U_s	V	24 DC, 230/400 AC
Operating range	<ul style="list-style-type: none"> AC operation DC operation 	
	V	0.8 ... 1.1 x U_s
	V	0.9 ... 1.15 x U_s
Measurement voltage	V	Max. 690
Response value U_{resp}	V	20 ... 400 adjustable
Rated insulation voltage U_i	<ul style="list-style-type: none"> For control circuit For outputs 	
	V	300
	V	690
Rated impulse withstand voltage U_{imp}	<ul style="list-style-type: none"> For control circuit For outputs 	
	V	6/4
	V	6
Rated power at U_s	W	3
Frequency ranges	Hz	50/60
Rated operational current I_e (relay outputs) at	<ul style="list-style-type: none"> AC-15 at 115 V AC-15 at 230 V DC-13 at 24 V DC-13 at 115 V DC-13 at 230 V 	
	A	--
	A	3 (NO contacts); 2 (NC contacts)
	A	2
	A	--
	A	--
Rated operational current I_e (semiconductor outputs) at	<ul style="list-style-type: none"> DC-13 at 115 V DC-13 at 230 V 	
	A	0.1
	A	--
Electrical endurance	Operat- ing cycles	2×10^5
Mechanical endurance	Operat- ing cycles	5×10^7
Switching frequency z	1/h	1200

Technical specifications

Type	3TK28 10	
Electrical specifications (continued)		
Conventional thermal current I_{th}	A	5, summation current max. 8
Conventional thermal current I_{th}		
• 1 contact	A	5
• 2 contacts	A	5
• 3 contacts	A	5
• 4 contacts	A	--
Fusing for output contacts		
Fuse links LV HRC Type 3NA, DIAZED Type 5SB, NEOZED Type 5SE, gL/gG operational class		
• gL/gG		--
• Quick	A	5
Maximum line resistance	Ω	--
Cable length from terminal to terminal	m	--
With Cu 1,5 mm ² and 150 nF/km		
Times		
Release time t_R		
• For sensor typ.	ms	--
• For sensor max.	ms	6 adjustable
• For mains failure typ.	ms	--
• For mains failure max.	ms	--
Simultaneity t_G	ms	∞
Temperatures		
Permissible ambient temperature		
• During operation	$^{\circ}\text{C}$	-25 ... +60
• During storage	$^{\circ}\text{C}$	-40 ... +75
Safety specifications		
Safety integrity level SIL CL		3
acc. to IEC 61508		
Performance level PL		e
acc. to ISO 13849-1		
Safety category CAT		4
acc. to EN 954-1		
Probability of a dangerous failure		
• Per hour (PFH _D)	1/h	1,49 x 10 ⁻⁹
• On demand (PFD)		--
Proof-test interval T1	a	20

Safety Relays

SIRIUS 3TK28

Dimensional drawings

Dimension drawings ¹⁾

3TK28 safety relays with screw terminals

3TK28 26 with screw terminals

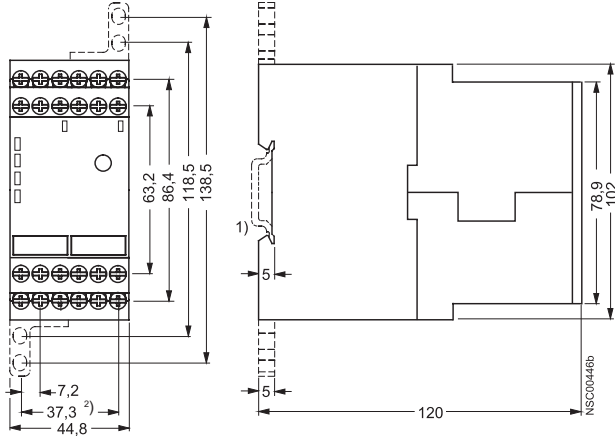

3TK28 safety relays with Spring Loaded terminals

3TK28 with spring loaded terminals

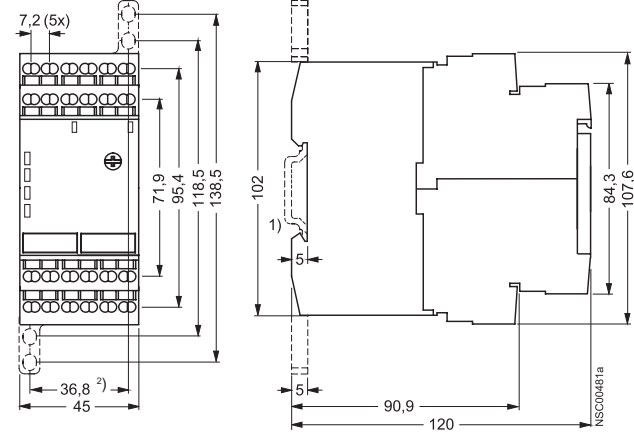

1) For 35 mm standard rail to EN 50 022.

2) Dimension for screw mounting. Screw mounting with 2 plug-in tabs 3RP19 03 per 3TK28 unit.

3TK28 10 with screw terminals

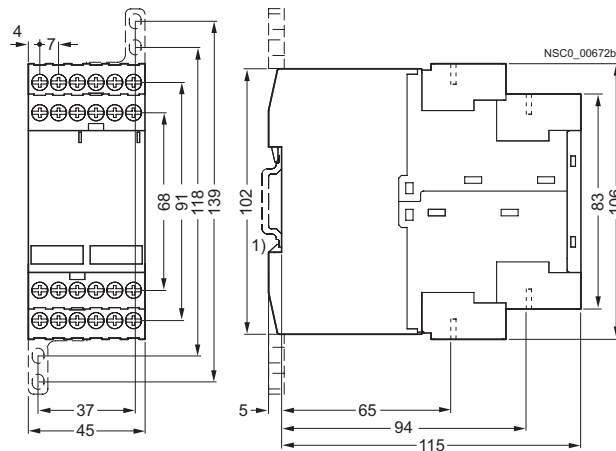

3TK28 10 with spring loaded terminals

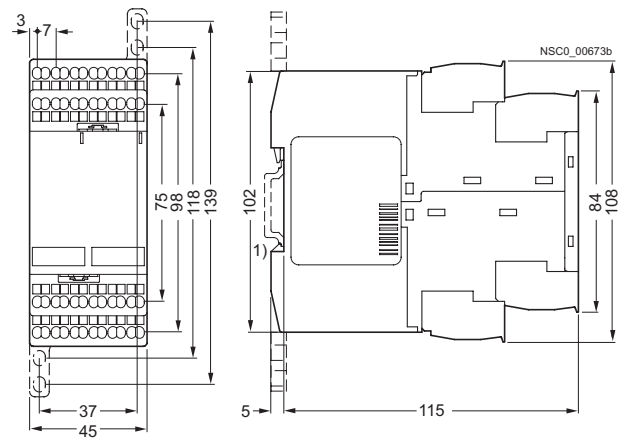

1) For standard mounting rail TH 35 according to EN 60715.

Overview

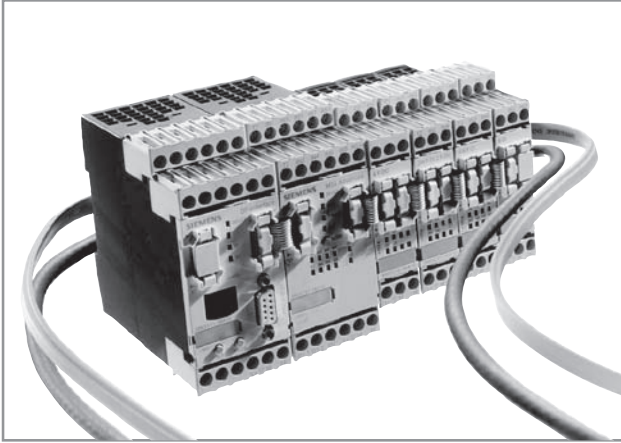

SIRIUS 3RK3 Modular Safety System

The 3RK3 Modular Safety System (MSS) is a freely parameterizable modular safety relay. Depending on the external circuit version, safety-oriented applications up to Performance Level e according to EN ISO 13849-1 or SIL 3 according to IEC 62061 can be realized.

The modular safety relay enables the interconnection of several safety applications.

The comprehensive error and status diagnostics provides the possibility of finding errors in the system and localizing signals from sensors. Plant downtimes can be reduced as the result.

The MSS comprises the following system components:

- Central units
- Expansion modules
- Interface modules
- Diagnostics modules
- Parameterization software
- Accessories

Central units

MSS Basic

The 3RK3 Basic central unit is used wherever more than three safety functions need to be evaluated and the wiring parameterization of safety relays would involve great cost and effort. It reads in inputs, controls outputs and communicates through an interface module with higher-level control systems. An application's entire safety program is processed in the central unit. The 3RK3 Basic central unit is the lowest expansion level and fully functional on its own, without the optional expansion modules.

MSS Advanced

The 3RK3 Advanced central unit is the consistent expansion of the Basic central unit with the functionality of an AS-i safety monitor. In addition to having a larger volume of project data and scope of functionality, it can be integrated into AS-Interface and therefore makes use of the many different possibilities offered by this bus system. The function can be optionally activated in the central unit.

The service-proven insulation piercing method of AS-Interface enables not only the distributed expansion of the project data volume using safe AS-i outputs, safe AS-i sensors and other MSS Advanced or safety monitors (F cross traffic) but also a highly flexible adaptation of the application, e.g. very fast connection of AS-i outputs, LV HRC command devices, position switches with and without interlocking, or light arrays.

Safety-oriented disconnection using MSS or by distributed means using safe AS-i outputs and the formation of switch-off groups can be implemented very easily. The same applies for any subsequent modifications. They are now easily possible by re-addressing, i.e. re-wiring is no longer necessary.

The AS-i bus is connected directly to the central unit.

MSS ASIsafe

The MSS ASIsafe basic and MSS ASIsafe extended central units are a logical development of the AS-i safety monitors based on the 3RK3 Modular Safety System.

Like MSS Advanced, MSS ASIsafe detects – in a comparable way to the safety monitors – safe sensor technology on the AS-i bus and switches actuators off in a safety-oriented manner via a configurable safety logic. It stands out by virtue of its greater project data volume, wider range of functions and the possibility of increasing the the integrated I/O project data volume by means of expansion modules from the MSS system family. In this case the range of functions, such as the number and type of the logic elements that can be interconnected, is equivalent to that of MSS Advanced.

Expansion modules

With the optional expansion modules, both safety-related and standard, the system is flexibly adapted to the required safety applications.

Interface modules

The DP interface module is used for transferring diagnostics data and device status data to a higher-level PROFIBUS network, e.g. for purposes of visualization via HMI. When using the Basic central unit, 32-bit cyclic data can be exchanged with the control system. If an Advanced/ASIsafe central unit is used, the number is doubled to 64-bit cycle data. The acyclic calling of diagnostics data is possible with both central units.

Diagnostics modules

Faults like a cross-circuit, for instance, are displayed directly on the diagnostic display. The fault is diagnosed directly in plain text by the detailed alarm message. The device is fully functional upon delivery. No programming is required.

Parameterization software

Using the MSS ES graphical parameterization tool it is very easy to create the safety functions as well as their logical links on the PC. You can define disconnection ranges, ON-delays, OFF-delays and other dependent factors, for example.

MSS ES also offers comprehensive functions for diagnostics and commissioning. Documentation of the MSS hardware layout and the parameterized logic is drawn up automatically.

Safety Relays

SIRIUS 3RK3 Modular Safety System

General data

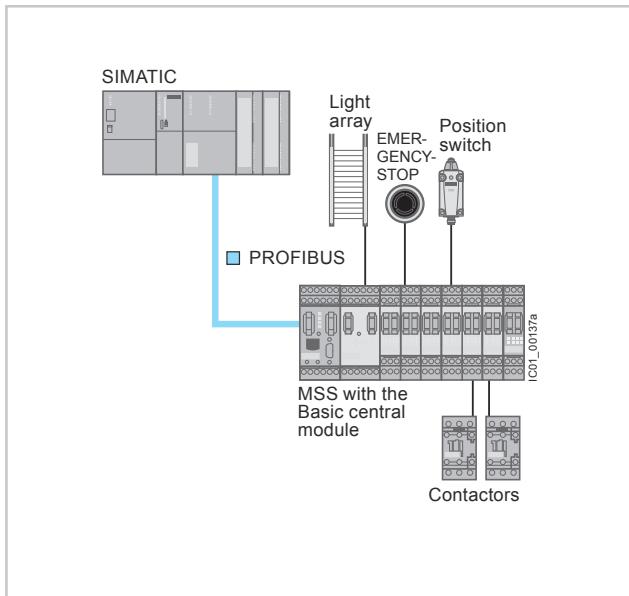

System configuration with the Basic central unit

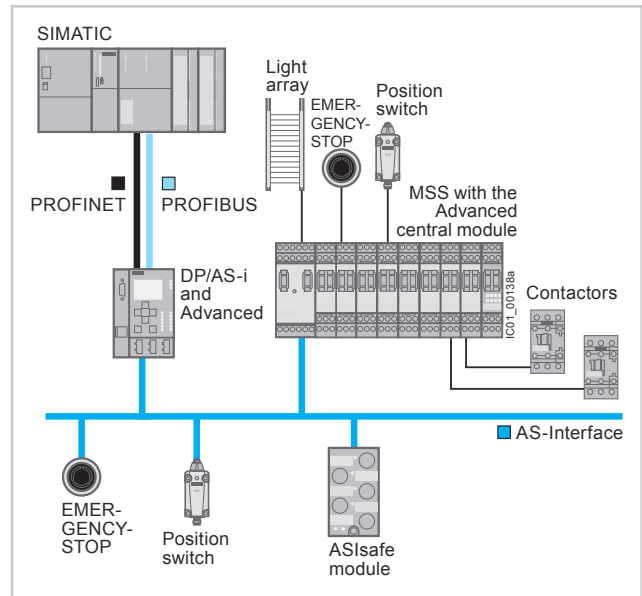

System configuration with the Advanced central unit

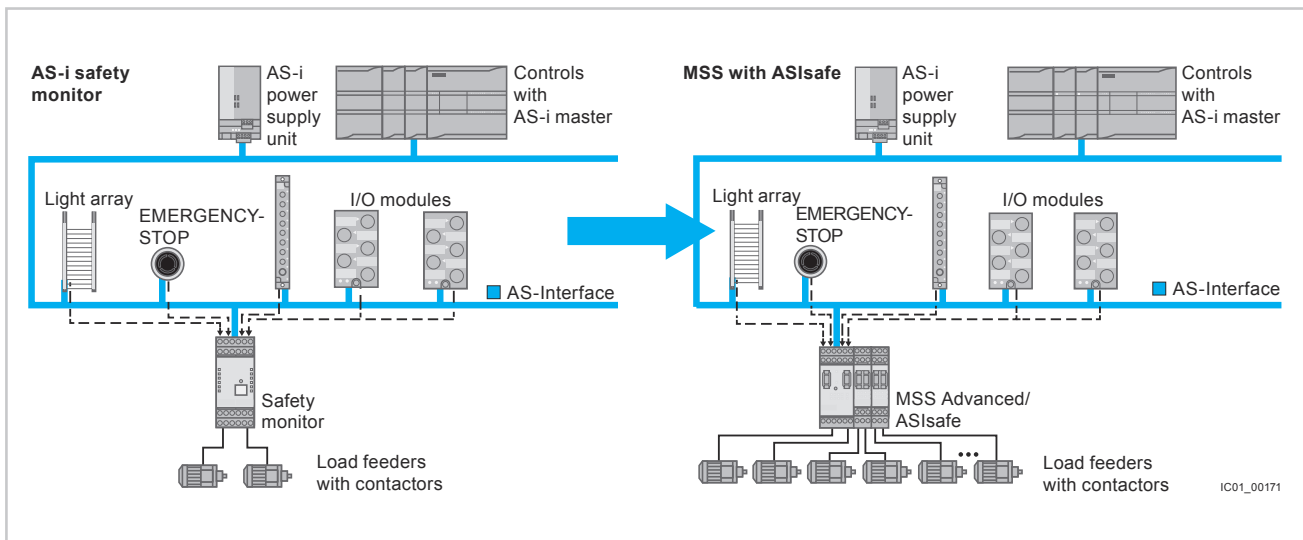

Further development of the system design: from the safety monitor to MSS Advanced/MSS ASIsafe

Safety Relays

SIRIUS 3RK3 Modular Safety System

General data

1
2
3
4
5
6
7
8
9
10
11
12
13

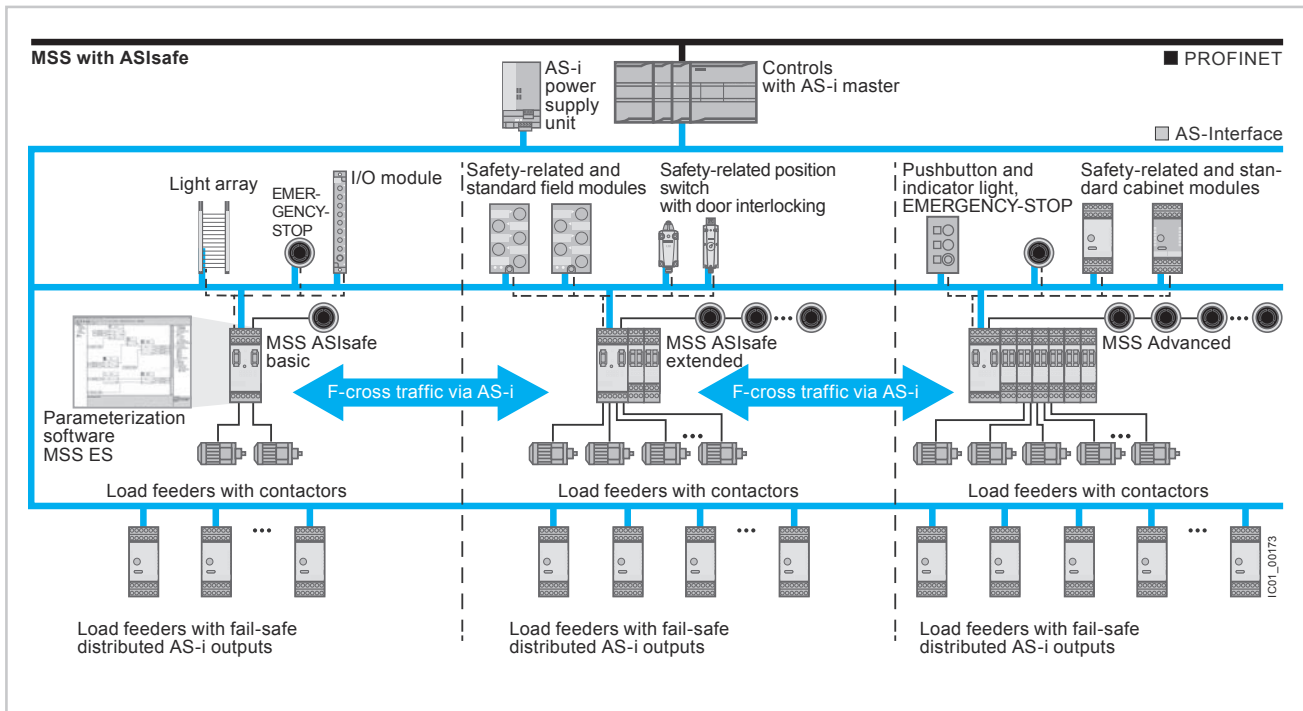

MSS with ASIsafe

Order No. scheme

Digit of the Order No.	1st - 4th	5th	6th	7th	8th	9th	10th	11th	12th	
	□□□□	□	□	□	-	□	□	□	□	
Modular safety system	3 R K 3									
Device type	□									
Device type	□ □									
Connection type	□									
Communications	□ □ □									
Version	□									
Example	3 R K 3	1	1	1	-	1	A	A	1	0

Note:

The Order No. scheme is presented here merely for information purposes and for better understanding of the logic behind the order numbers.

For your orders, please use the order numbers quoted in the catalog in the selection and ordering data.

Safety Relays

SIRIUS 3RK3 Modular Safety System

General data

Benefits

- More functionality and flexibility through freely configurable safety logic
- Suitable for all safety applications thanks to compliance with the highest safety standards in factory automation
- For use all over the world through compliance with all product-relevant, globally established certifications
- Modular hardware configuration
- Parameterization by means of software instead of wiring
- Removable terminals for greater plant availability
- Distributed collection from sensors and disconnection of actuators through AS-Interface
- All MSS ES logic functions are also usable for AS-Interface, e. g. muting, protective door with interlocking
- Up to 12 independent safe switch-off groups on the AS-i bus
- Volume of project data can be greatly increased by means of AS-Interface
- Up to 50 two-channel enabling circuits per system

Communication through PROFIBUS

The 3RK3 Modular Safety System can be connected to PROFIBUS through the DP interface and can exchange data with higher-level control systems.

The MSS supports among other things:

- Baud rates up to 12 Mbit/s
- Automatic baud rate detection
- Cyclic services (DPV0) and acyclic services (DPV1)
- Exchange of 32-bit cyclic data with MSS Basic or 64-bit cyclic data with MSS Advanced/MSS ASIsafe
- Diagnostics using data record invocations

AS-Interface communication

The 3RK3 Modular Safety System can be integrated into AS-Interface with the Advanced and ASIsafe central units.

- MSS can read in up to 31 AS-i sensors
- Up to 12 preprocessed signals per MSS can be placed on the AS-i bus, e.g. for F-cross traffic or for disconnecting safe AS-i outputs
- Safe cross-traffic between MSS Advanced and MSS ASIsafe or with other AS-i safety monitors
- Standard signals, e.g. for acknowledgement, can also be placed on the bus

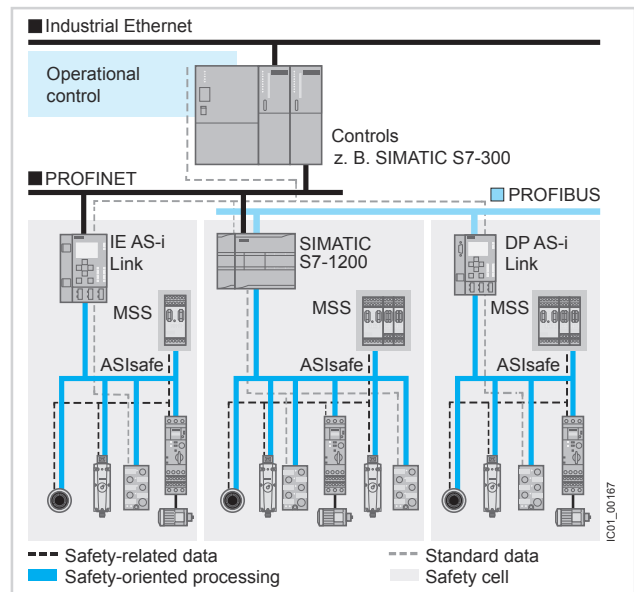

Integration of MSS into AS-Interface as ASIsafe Solution Local

MSS with communication function [see page 13/147 onwards](#).

Accessories [see page 13/149 onwards](#).

For more information on AS-Interface with ASIsafe, [see also Chapter 14 on Industrial Communication](#).

Selection and ordering data



PU (UNIT, SET, M) = 1
PS* = 1 unit



3RK3 111-1AA10



3RK3 121-1AC00
3RK3 122-1AC00
3RK3 131-1AC10

Version	DT	Screw terminals 	DT	Spring-type terminals 	
		Order No.	Price per PU	Order No.	Price per PU
Central units					
3RK3 Basic					
Central unit with safety-oriented inputs and outputs					
<ul style="list-style-type: none"> • 8 non-fail-safe inputs • 1 two-channel relay output • 1 two-channel solid-state output 					
Max. 7 expansion modules can be connected					
<u>Note:</u>					
Memory module 3RK3 931-0AA00 is included in the scope of supply.					
	▶	3RK3 111-1AA10	A	3RK3 111-2AA10	
3RK3 Advanced					
Central units for connecting to AS-Interface with safety-oriented inputs and outputs and extended scope of functions					
<ul style="list-style-type: none"> • 8 non-fail-safe inputs • 1 two-channel relay output • 1 two-channel solid-state output 					
Max. 9 expansion modules can be connected					
<u>Note:</u>					
Memory module 3RK3 931-0AA00 is included in the scope of supply.					
	▶	3RK3 131-1AC10	A	3RK3 131-2AC10	
3RK3 ASIsafe basic					
Central units for connecting to AS-Interface with safety-oriented inputs and outputs and extended scope of functions					
<ul style="list-style-type: none"> • 2 fail-safe inputs • 6 non-fail-safe inputs • 1 two-channel relay output • 1 two-channel solid-state output 					
No expansion modules can be connected					
<u>Note:</u>					
Memory module 3RK3 931-0AA00 is included in the scope of supply.					
A		3RK3 121-1AC00	A	3RK3 121-2AC00	
3RK3 ASIsafe extended					
Central units for connecting to AS-Interface with safety-oriented inputs and outputs and extended scope of functions					
<ul style="list-style-type: none"> • 4 fail-safe inputs • 4 non-fail-safe inputs • 1 two-channel relay output • 1 two-channel solid-state output 					
Max. 2 expansion modules can be connected					
<u>Note:</u>					
Memory module 3RK3 931-0AA00 is included in the scope of supply.					
A		3RK3 122-1AC00	A	3RK3 122-2AC00	

Note:

More information on the Internet at www.siemens.com/sirius-mss.

Safety Relays

SIRIUS 3RK3 Modular Safety System

Expansion modules, interface modules,
operating & monitoring modules

Selection and ordering data

PU (UNIT, SET, M) = 1
PS* = 1 unit



3RK3 211-1AA10
3RK3 221-1AA10
3RK3 231-1AA10
3RK3 242-1AA10



3RK3 251-1AA10





3RK3 311-1AA10
3RK3 321-1AA10



3RK3 511-1BA10



3RK3 611-3AA00







Version	DT	Screw terminals 	DT	Spring-type terminals 	
		Order No.	Price per PU	Order No.	Price per PU
Expansion modules					
4/8 F-DI Safety-related input modules • 8 inputs	A	3RK3 211-1AA10	A	3RK3 211-2AA10	
2/4 F-DI 1/2 F-RO Safety-related input/output modules • 4 inputs • 2 single-channel relay outputs	A	3RK3 221-1AA10	A	3RK3 221-2AA10	
2/4 F-DI 2F-DO Safety-related input/output modules • 4 inputs • 2 two-channel solid-state outputs	▶	3RK3 231-1AA10	A	3RK3 231-2AA10	
4/8 F-RO Safety-oriented output modules • 8 single-channel relay outputs	A	3RK3 251-1AA10	▶	3RK3 251-2AA10	
4 F-DO Safety-oriented output modules • 4 two-channel solid-state outputs	A	3RK3 242-1AA10	▶	3RK3 242-2AA10	
8 DI Standard input module • 8 inputs	▶	3RK3 321-1AA10	▶	3RK3 321-2AA10	
8 DO Standard output module • 8 solid-state outputs	A	3RK3 311-1AA10	A	3RK3 311-2AA10	
Interface modules					
DP interface PROFIBUS DP interface, 12 Mbit/s, RS 485, 32-bit cyclic data exchange with Basic central unit or 64-bit with Advanced central unit, acyclic exchange of diagnostics data	A	3RK3 511-1BA10	A	3RK3 511-2BA10	
Operating and monitoring modules					
Diagnostics module	A	3RK3 611-3AA00		--	

Note:

Connection cable required, [see page 13/149](#).

More information on the Internet at
www.siemens.com/sirius-mss.

Selection and ordering data

Version	DT	Order No.	Price per PU	PU (UNIT, SET, M)	PS*
Connection cables (essential accessory)					
Connection cables					
For connection of					
	Central units with expansion modules or interface module	Diagnostics modules with central unit or interface module			
3UF7 932-0AA00-0	✓	✓	• Length 0.025 m (flat) ▶	3UF7 930-0AA00-0	1 1 unit
--	--	✓	• Length 0.1 m (flat) ▶	3UF7 931-0AA00-0	1 1 unit
--	--	✓	• Length 0.3 m (flat) ▶	3UF7 935-0AA00-0	1 1 unit
--	--	✓	• Length 0.5 m (flat) ▶	3UF7 932-0AA00-0	1 1 unit
--	--	✓	• Length 0.5 m (round) ▶	3UF7 932-0BA00-0	1 1 unit
--	--	✓	• Length 1.0 m (round) ▶	3UF7 937-0BA00-0	1 1 unit
--	--	✓	• Length 2.5 m (round) ▶	3UF7 933-0BA00-0	1 1 unit
PC cables and adapters					
PC cables ▶					
	For connecting to the serial interface of a PC/PG, for communication with 3RK3 through the system interface			3UF7 940-0AA00-0	1 1 unit
3UF7 940-0AA00-0					
USB PC cables ▶					
	For connecting to the USB interface of a PC/PG, for communication with 3RK3 through the system interface, recommended for use in connection with 3RK3			3UF7 941-0AA00-0	1 1 unit
USB/serial adapters					
			B	3UF7 946-0AA00-0	1 1 unit
	For connecting the RS 232 PC cable to the USB interface of a PC				
Interface covers					
Interface covers ▶					
	For system interface			3UF7 950-0AA00-0	1 5 units
3UF7 950-0AA00-0					
Memory modules					
Memory modules ▶					
	For backing up the complete parameterization of the 3RK3 Modular Safety System without a PC/PG through the system interface			3RK3 931-0AA00	1 1 unit
3RK3 931-0AA00					
Door adapters					
Door adapters					
	For external connection of the system interface, e.g. outside a control cabinet			3UF7 920-0AA00-0	1 1 unit
3UF7 920-0AA00-0					
Push-in lugs					
Push-in lugs for screw fixing					
	e.g. on mounting plate, 2 units required per device Can be used for 3RK3			3RP19 03	1 10 units
3RP19 03					
Manuals					
Manuals for the 3RK3 Modular Safety System (MSS)					
		• English	C	3ZX1 012-0RK31-1AC1	1 1 unit

✓ Available
-- Not available



Safety Relays

SIRIUS 3RK3 Modular Safety System

Accessories

Parameterization, startup and diagnostics software for 3RK3

- Runs under Windows XP Professional (Service Pack 2 or 3), Windows 7 32/64 Bit Professional/Ultimate/Enterprise (Service Pack 1)
- Delivered without PC cable. Please order separately, see page 13/149.

Version	DT	Order No.	Price per PU	PU (UNIT, SET, M)	PS*
Modular Safety System ES 2008 Basic					
 <p>3ZS1 314-4CC10-0YA5</p>	Floating license for one user Engineering software in limited-function version for diagnostics purposes, software and documentation on CD, 3 languages (German/English/French), communication through the system interface				
	• License key on USB stick, Class A	A	3ZS1 314-4CC10-0YA5	1	1 unit
	• License key download, Class A	▶	3ZS1 314-4CE10-0YB5	1	1 unit
Modular Safety System ES 2008 Standard					
 <p>3ZS1 314-5CC10-0YA5</p>	Floating license for one user Engineering software, software and documentation on CD, 3 languages (German/English/French), communication through system interface				
	• License key on USB stick, Class A	B	3ZS1 314-5CC10-0YA5	1	1 unit
	• License key download, Class A	▶	3ZS1 314-5CE10-0YB5	1	1 unit
	Powerpack for MSS ES 2008 Basic to Standard	A	3ZS1 314-5CC10-0YD5	1	1 unit
	Floating license for one user, engineering software, license key on USB stick, Class A, 3 languages (German/English/French), communication through the system interface				
	Software Update Service	▶	3ZS1 314-5CC10-0YL5	1	1 unit
	For 1 year with automatic extension, assuming the current software version is in use, engineering software, software and documentation on CD, communication through the system interface				
Modular Safety System ES 2008 Premium					
 <p>3ZS1 314-6CC10-0YA5</p>	Floating license for one user Engineering software, software and documentation on CD, 3 languages (German/English/French), communication through PROFIBUS or the system interface, online diagnostics via PROFIBUS, creating, importing and exporting macros				
	• License key on USB stick, Class A	▶	3ZS1 314-6CC10-0YA5	1	1 unit
	• License key download, Class A	▶	3ZS1 314-6CE10-0YB5	1	1 unit
	Powerpack for MSS ES 2008 Standard to Premium	A	3ZS1 314-6CC10-0YD5	1	1 unit
	Floating license for one user, engineering software, license key on USB stick, Class A, 3 languages (German/English/French), communication through PROFIBUS or the system interface, online diagnostics via PROFIBUS, creating, importing and exporting macros				
	Software Update Service	▶	3ZS1 314-6CC10-0YL5	1	1 unit
	For 1 year with automatic extension, assuming the current software version is in use, engineering software, software and documentation on CD, communication through PROFIBUS or the system interface, online diagnostics via PROFIBUS, creating, importing and exporting macros				

Technical specifications

Central units and expansion modules

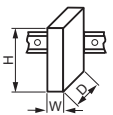
Type	Central units				Expansion modules							
	Basic	Advanced	ASIsafe basic	ASIsafe extended	4/8F-DI	2/4 F-DI 1/2 F-RO	2/4 F-DI 2F-DO	4/8 F-RO	4 F-DO	8 DI	8 DO	
Dimensions (W x H x D)												
												
• Screw terminals	mm	45 x 111 x 124				22.5 x 111 x 124		45 x 111 x 124		22.5 x 111 x 124		
• Spring-type terminals	mm	45 x 113 x 124				22.5 x 113 x 124		45 x 113 x 124		22.5 x 113 x 124		
Device data												
Shock resistance (sine pulse)	g/ms	15/11										
Touch protection according to EN 50274 and IEC 60529		IP20										
Permissible mounting position		Vertical mounting surface (+10°/-10°), deviating mounting positions are permitted for reduced ambient temperature										
Minimum distances		For heat dissipation through convection from the devices 25 mm to the ventilation openings (top and bottom)										
Permissible ambient temperature												
• During operation	°C	-20 ... +60										
• During storage and transport	°C	-40 ... +85										
Number of sensor inputs (single-channel)												
• Fail-safe		--	--	2	4	8	4	4	--	--	--	--
• Not fail-safe		8	8	6	4	--	--	--	--	8	8	--
Number of test outputs		2	2	2	2	2	2	2	--	--	--	--
Number of outputs												
• Relay outputs												
- Single channel		--	--	--	--	--	2	--	8	--	--	--
- Two-channel		1	1	1	1	--	--	--	--	--	--	--
• Solid-state outputs												
- Single channel		--	--	--	--	--	--	--	--	--	--	8
- Two-channel		1	1	1	1	--	--	2	--	4	--	--
Weight	g	300	300	300	300	160	160	160	400	135	125	160
Installation altitude above sea level	m	2 000										
Environmental data												
EMC interference immunity		IEC 60947-5-1										
Vibrations												
• Frequency	Hz	5 ... 500										
• Amplitude	mm	0.75										
Climatic withstand capability		IEC 60068-2-78										
Electrical specifications												
Rated control supply voltage U_s according to IEC 61131-2	V	24 DC 15 % ¹⁾										
Operating range		0.85 ... 1.15 x U_s										
Rated insulation voltage U_i	V	300	300	300	300	50	300	50	300	50	50	50
Rated impulse voltage U_{imp}	kV	4	4	4	4	0,5	4	0,5	4	0,5	0,5	0,5
Total current consumption	mA	185	185	185	185	60	85	85	140	8	78	60
Rated power at U_s	W	4.5	4.5	4.5	4.5	1.5	2	2	3	4.8	1.9	1.5
Utilization categories acc. to IEC 60947-5-1 (relay outputs)												
• AC-15 at 230 V	A	2	2	2	2	--	2	--	2	--	--	--
• DC-13 at 24 V (semiconductor outputs)	A	1	1	1	1	--	1	--	1	--	--	--
• DC-13 at 24 V	A	1.5	1.5	1.5	1.5	--	--	1	--	2	--	0.5
Mechanical endurance During rated operation	Operating cycles (relay)	10 x 10 ⁶	10 x 10 ⁶	10 x 10 ⁶	10 x 10 ⁶	--	10 x 10 ⁶	--	10 x 10 ⁶	--	--	--

¹⁾ Device current supply through a power supply unit acc. to IEC 60536 protection class (SELV or PELV).

Safety Relays

SIRIUS 3RK3 Modular Safety System

Technical data





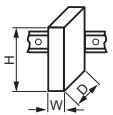





Type	Central units				Expansion modules							
	Basic	Advanced	ASIsafe basic	ASIsafe extended	4/8F-DI	2/4 F-DI 1/2 F-RO	2/4 F-DI 2F-DO	4/8 F-RO	4 F-DO	8 DI	8 DO	
Electrical specifications (cont.)												
Switching frequency z for rated operational current	1/h	1 000	1 000	1 000	1 000	--	1 000	1 000	360	1 000	--	1 000
Conventional thermal current I_{th}	A	2/1.5	2/1.5	2/1.5	2/1.5	--	1	1	3	2	--	0.5
Protection for output contacts												
Fuse links LV HRC Type 3NA, DIAZED Type 5SB, NEOZED Type 5SE												
• Operational class gG	A	4	4	4	4	--	4	--	4	--	--	--
• Operational class quick response	A	6	6	6	6	--	6	--	6	--	--	--
Safety specifications												
Probability of a dangerous failure												
• Per hour (PFH _d)	1/h	5.14×10^{-9}	2.8×10^{-9}	2.8×10^{-9}	2.8×10^{-9}	1.89×10^{-9}	3.79×10^{-9}	2.7×10^{-9}	7.15×10^{-9}	3.18×10^{-9}	--	--
• On demand (PFD)	1/h	1.28×10^{-5}	1.7×10^{-4}	1.7×10^{-4}	1.7×10^{-4}	4.29×10^{-6}	5.85×10^{-6}	8.34×10^{-6}	4.36×10^{-5}	2.2×10^{-5}	--	--
Parameters for cables												
Line resistance		100	100	100	100	100	100	100	--	--	100	--
Cable length from terminal to terminal With Cu 1.5 mm ² and 150 nF/km	m	1 000	1 000	1 000	1 000	1 000	1 000	1 000	--	--	1 000	--
Conductor capacity	nF	330	330	330	330	330	330	330	--	--	330	--

Interface and diagnostics modules





















Type	Interface modules		Diagnostics modules	
Dimensions (W x H x D)				
				
• Screw terminals	mm	45 x 111 x 124		96 x 60 x 44
• Spring-type terminals	mm	45 x 113 x 124		--
Device data				
Shock resistance (sine pulse)	g/ms	15/11		
Touch protection according to EN 50274 and IEC 60529		IP20		
Permissible mounting position		Vertical mounting surface (+10°/-10°), deviating mounting positions are permitted for reduced ambient temperature		
Minimum distances		For heat dissipation through convection from the devices 25 mm to the ventilation openings (top and bottom)		
Permissible ambient temperature				
• During operation	°C	-20 ... +60		
• During storage and transport	°C	-40 ... +85		
Weight	g	270		90
Installation altitude above sea level	m	2 000		
Environmental data				
EMC interference immunity		IEC 60947-5-1		
Vibrations				
• Frequency	Hz	5 ... 500		
• Amplitude	mm	0.75		
Climatic withstand capability		IEC 60068-2-78		
Electrical specifications				
Rated control supply voltage U_s according to IEC 61131-2	V	24 DC 15 %	24 DC 15 % via connecting cable to the central unit	
Operating range		0.85 ... 1.15 x U_s		
Rated insulation voltage U_i	V	50		
Rated impulse voltage U_{imp}	kV	0,5		
Total current consumption	mA	--		24
Rated power at U_s	W	--		0.6

Application

The 3RK3 Modular Safety System can be used for all safety-oriented requirements in the manufacturing industry and offers the following safety functions:

	Symbol	MSS Basic	MSS Advanced, MSS ASIsafe
Monitoring functions			
Universal monitoring Evaluation of any binary signals from single-channel and two-channel sensors		--	✓
EMERGENCY-STOP Evaluation of EMERGENCY-STOP devices with positive-opening contacts		✓	✓
Safety shutdown mats Evaluation of safety shutdown mats with NC contacts and/or cross-circuit detection		✓	✓
Protective door monitoring Evaluation of protective door signals and/or protective flap signals		✓	✓
Protective door interlocking mechanism Evaluation of protective doors with interlocking and locking/unlocking of this device		--	✓
Enabling switches Evaluation of OK buttons with NO contact		✓	✓
Two-hand operator controls Evaluation of two-hand operation consoles		✓	✓
ESPE monitoring Evaluation of electro-sensitive protective equipment such as light arrays and laser scanners		✓	✓
Muting Short-time bridging of electro-sensitive protective equipment, 2/4 sensors in parallel, 4 sensors sequentially		--	✓
Operating mode selector switches Evaluation of operating mode selector switches with NO contacts		✓	✓
Monitoring of AS-i (AS-i 2F-DI) Logic element for monitoring of AS-i input slaves		--	✓

✓ Available
-- Not available

	Symbol	MSS Basic	MSS Advanced, MSS ASIsafe
Logic operation functions			
AND		✓	✓
OR		✓	✓
XOR		✓	✓
NAND		✓	✓
NOR		✓	✓
Negation		✓	✓
Flip-flop		✓	✓
Counter functions			
Counter 0 -> 1		✓	✓
Counter 1 -> 0		✓	✓
Counter 0 -> 1/1 -> 0		✓	✓
Timer functions			
With ON-delay		✓	✓
Passing make contact		✓	✓
With OFF-delay		✓	✓
Clock pulsing		✓	✓
Start functions			
Monitored start		✓	✓
Manual start		✓	✓
Output functions			
Standard output		✓	✓
F output		✓	✓
AS-i output function		--	✓
Status functions			
Element status		--	✓

Safety Relays

SIRIUS 3RK3 Modular Safety System

Dimensional drawings

Dimensional drawings

Central module with screw terminals

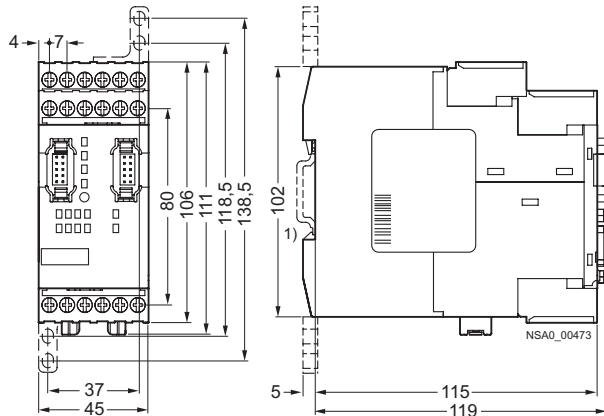

Central module with spring-type terminals

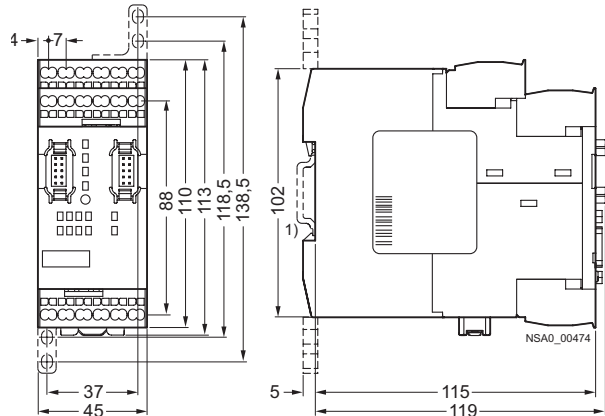

Expansion module with screw terminals

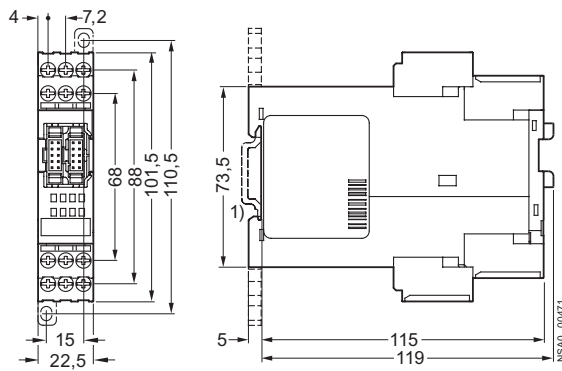

Expansion module with spring-type terminals

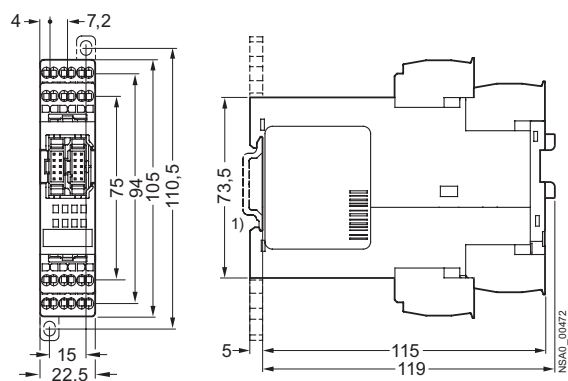

Interface module with screw terminals

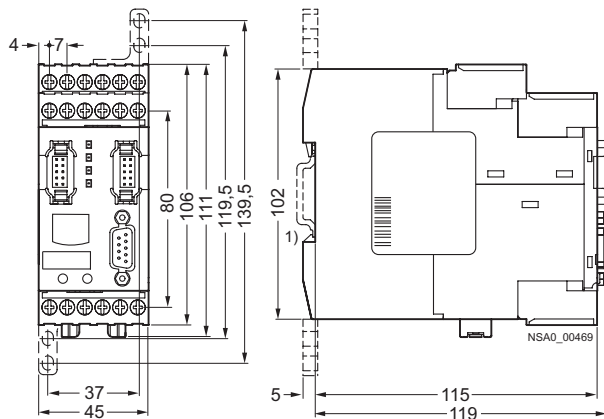

Interface module with spring-type terminals

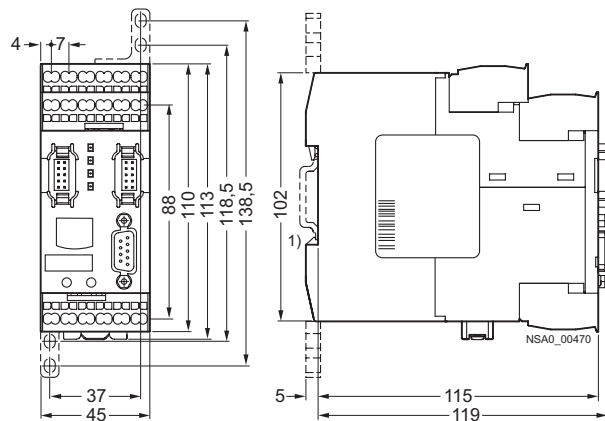

¹⁾ For standard mounting rail TH 35 according to EN 60715.