

Industrial Control Relays Type X

Class 8501

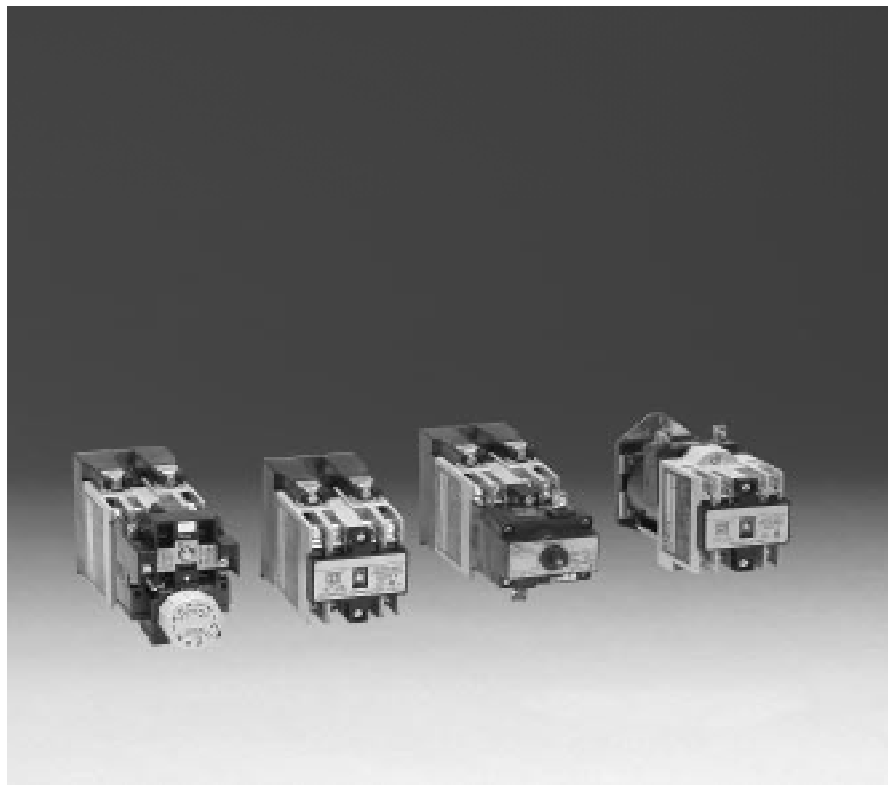

CATALOG CONTENTS

Description.....	Page
General	1-3
Accessories	4
Application Data	5-7
Product Data	8-9
Dimensions	10



SQUARE D
GROUPE SCHNEIDER

Industrial Control Relays

Type X - NEMA Type Relays

General Information

Class 8501 Type X relays combine a rugged, heavy-duty design with modular construction for greater flexibility. They are ideal for those applications where long life, high reliability and ease of maintenance are important. The Type X family offers a complete line of relays and accessories for all control applications.

- Specified In Major Automotive Plants
- Modular Design Provides Greater Versatility and Reduction In Stock
- XUDO Version Ideal for Power Plant Applications
- Replaceable, Convertible Contacts
- Extremely Reliable Contacts
- 600 Volt 10 Ampere Rating (NEMA Type A600)
- Plug-In Color-Coded Contact Cartridges
- Mechanical Tie Between Contact Cartridges
- 1 and 3 Minute Timing Relays
- 8 Pole Latching Relays
- DC Operated Relays

Modular Construction

A basic relay has room for up to 4 convertible contact cartridges. It can be expanded to 6 or 8 poles by installing an adder deck. A 10 or 12 pole relay can be built by adding a second deck. The same adder deck is used for both the middle and upper decks. Latching and timing relays are made by adding a latch or timer attachment to a basic relay. This reduces the number of components required in inventory.

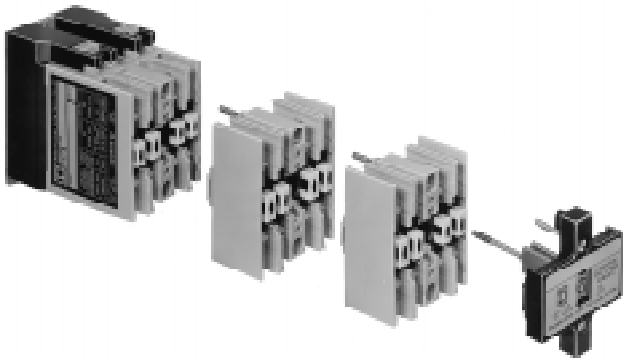

Common Mechanical Tie Non-Overlapping Contacts



The Type X relay is designed to provide a significant degree of non-overlap between N.O. and N.C. contacts during normal operation. In addition, a common mechanical tie between all contact cartridges is provided. Therefore, the Type X relay is suitable for use in self-checking circuits for press control and automatic transfer line applications. Since the T-bar actuator is held captive in the cover plate, there is no chance of losing or forgetting to replace the mechanical tie when converting a contact or adding another deck.

Plug-In Contact Cartridges

Contact Conversion Without Removing Terminal Screws or Wires

1. Remove relay cover and captive T-bar actuator.
2. Remove contact cartridge and rotate 180°.
3. Plug contact cartridge back in.
4. Replace T-bar actuator and cover.

Note: For additional information regarding contact cartridges see Page 9.

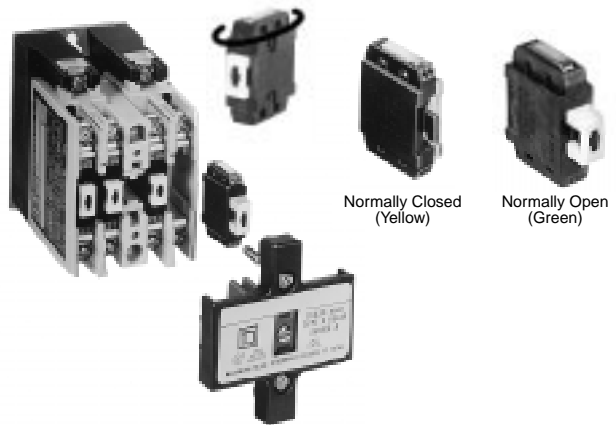

Ring Or Spade Lugs – Form Y414

For relays with terminals that will accept ring or spade lugs, add Form Y414 to the Class and Type number of the device being ordered. Form Y414 is available on all AC relays, DC relays and attachments at no additional charge. Ring or spade lugs must have an outside diameter of .31 inch or less and an inside diameter large enough to accommodate a #6 screw. Lugs should accept #12 – #14 gauge (AWG) stranded copper wire. UL Listing is maintained only when AMP Plasti-Grip® #32958 insulated-barrel ring-tongue lugs are used.

Normally Closed Contacts

Contact conversion is so simple that it is generally more economical to purchase relays with all contacts N.O. and convert contacts to N.C. as required. If it is preferred that relays be factory assembled with a combination of N.O. and N.C. contacts, change the type number so that following the “XO”, the first number indicates the number of normally open contacts (N.O.) and the second number indicates the number of normally closed contacts (N.C.). As indicated on contact arrangement tables found on Page 6.

There is a price adder for the factory installation of normally closed (N.C.) contacts.

How to Order:

To Order Specify:	Catalog Number			
	Class	Type	Voltage Code	Form(s)
<ul style="list-style-type: none"> • Class Number • Type Number • Voltage Code • Form(s) 	8501	XO40	V02	Y414



Industrial Control Relays

Type X - NEMA Type Relays/AC

General Information, Order Information

AC Control Relays

In addition to all of the features listed on the previous page, the Type XO relay also provides:

- Straight-through wiring
- Plug-in contact cartridges for easy contact conversion and replacement
- Contact conversion without removing terminal screws or wires
- Self-lifting pressure wire connectors that will accept up to two #12-18 (AWG) gauge stranded copper wires
- Replaceable coil



Type XO40

 File CCN E78403 NKCR
 File Class LR 60905 3211 03

Normally Open Convertible Instantaneous Contacts	Control Relay Δ
	Type
0	XO00 *
2	XO20 *
3	XO30 *
4	XO40 *
6	XO60 *
8	XO80 *
10	XO1000 *
12	XO1200 *

Δ A maximum of 8 N.C. contacts is allowed on 9-12 pole relays.

AC Master Relays

- 20 Ampere Contact Rating due to use of Master Contact Cartridges
- Provisions for Standard Cartridges to be used in contact cavities not occupied by Master Cartridges in 2-8 pole AC relay
- Straight-through wiring
- Plug-in contact cartridges for easy contact conversion and replacement
- Contact conversion without removing terminal screws or wires
- Self-lifting pressure wire connectors that will accept up to two #12-18 (AWG) gauge stranded copper wires
- Replaceable coil



Type XMO40

 File CCN E78403 NKCR
 File Class LR 60905 3211 03

Number of N.O. 20 Ampere Convertible Contacts	Open Type \dagger
	Type
2	XMO20 *
4	XMO40 *
6	XMO60 *

\dagger Attachments not permitted on this relay.

AC Timing Relays

- Easily convertible On Delay or Off Delay
- Two adjustable timing ranges
- Repeat accuracy well above $\pm 10\%$
- Convertible 1 N.O. and 1 N.C. timed contacts
- Large knob for easy adjustment of time delay
- Off Delay mode times out even after loss of power

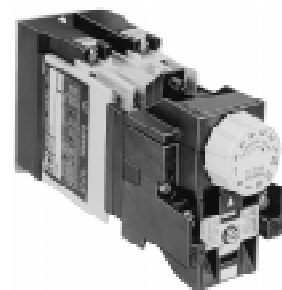

Type XO40XTE1

 File CCN E78403 NKCR
 File Class LR 60905 3211 03

Timing Mode	Normally Open Convertible Instantaneous Contacts	Timed Convertible Contacts		Timing Relay	
		N.O.	N.C.	0.2-60 sec.	5-180 sec.
				Type	Type
On Delay	0	1	1	XO00XTE1 *	XO00XTE2 *
	2	1	1	XO20XTE1 *	XO20XTE2 *
	4	1	1	XO40XTE1 *	XO40XTE2 *
Off Delay	0	1	1	XO00XTD1 *	XO00XTD2 *
	2	1	1	XO20XTD1 *	XO20XTD2 *
	4	1	1	XO40XTD1 *	XO40XTD2 *

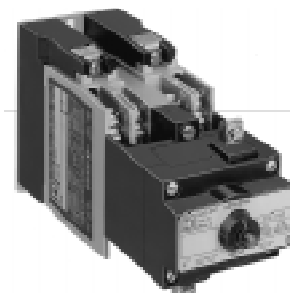

AC Latching Relays

- Mechanical Latch holds all contacts switched even after removal of power from replaceable Latching Coil.
- Provides sequence memory in the event of power loss. Ideal for press control, process control and punch presses.
- Replaceable Unlatch Coil to switch contacts back to original state.
- Continuously rated Unlatch Coil (no coil clearing contacts required).



Type XO40XL

Normally Open Convertible Instantaneous Contacts	Latching Relay
	Type
2	XO20XL *
3	XO30XL *
4	XO40XL *
6	XO60XL *
8	XO80XL *

 File CCN E78403 NKCR
 File Class LR 60905 3211 03

* Voltage Code must be specified to order this product. Refer to standard voltage codes listed below and insert as shown in How To Order.

Voltage Codes:

AC Voltages — Hz.	Code
12 – 60	V11
24 – 60	V01
24 – 50	V12
48 – 60	V18
48 – 50	V16
120 – 60/110 – 50	V02
208 – 60	V08
240 – 60/220 – 50	V03
277 – 60	V04
480 – 60/440 – 50	V06
600 – 60/550 – 50	V07

How to Order:

To Order Specify:	Catalog Number		
• Class Number	Class	Type	Voltage Code
• Type Number	8501	XO40	V02
• Voltage Code			



Industrial Control Relays

Type X - NEMA Type Relays/DC

General Information, Order Information



DC Control Relays

- Replaceable, highly reliable pure DC Power Plant: no economizing resistors, overlapping contacts or dual-wound coil
- Utilizes the same Type XB Adder Decks and attachments as the AC Version
- Offers all the features of the AC Relay
- Available in up to 8 Poles
- All contact poles are usable since no overlapping contacts are needed
- Self-lifting pressure wire connectors that will accept up to two #12-18 (AWG) gauge stranded copper wires



Type XDO40

Normally Open Convertible Instantaneous Contacts	Control Relay	
	Type	
0	XDO00 *	
2	XDO20 *	
4	XDO40 *	
6	XDO60 *	
8	XDO80 *	

 File CCN E78403 NKCR
 File Class LR 60905 3211 03

DC Timing Relays

- Easily convertible On Delay or Off Delay
- Two adjustable timing ranges
- Repeat accuracy well above $\pm 10\%$
- Convertible 1 N.O. and 1 N.C. timed contacts
- Large knob for easy adjustment of time delay
- Off Delay mode times out even after loss of power

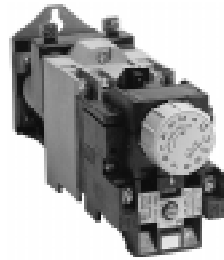

Type XDO40XTE2

 File CCN E78403 NKCR
 File Class LR 60905 3211 03

Timing Mode	Normally Open Convertible Instantaneous Contacts	Timed Convertible Contacts		Timing Relay	
		N.O.	N.C.	0.2-60 sec.	5-180 sec.
				Type	Type
On Delay	0	1	1	XDO00XTE1 *	XDO00XTE2 *
	2	1	1	XDO20XTE1 *	XDO20XTE2 *
	4	1	1	XDO40XTE1 *	XDO40XTE2 *
Off Delay	0	1	1	XDO00XTD1 *	XDO00XTD2 *
	2	1	1	XDO20XTD1 *	XDO20XTD2 *
	4	1	1	XDO40XTD1 *	XDO40XTD2 *

* Voltage code must be specified to order this product. Refer to standard voltage code listed below and insert as shown in How To Order.

Voltage Codes for 8501 XUDO Relays ONLY:		Voltage Codes for 8501 XDO Relays:	
DC Voltages	Code	DC Voltages	Code
6	V50	6	V50
12	V51	12	V51
24	V53	24	V53
48	V56	32	V54
125	V63	48	V56
250	V67	72	V58
		90	V59
		115/125	V62
		230/250	V66

DC Latching Relays

- Mechanical Latch holds all contacts switched even after removal of power from replaceable Latching Coil
- Provides sequence memory in the event of power loss
- Ideal for sequencing applications such as press control, process control and punch presses
- Replaceable Unlatch coil to switch contacts back to original state

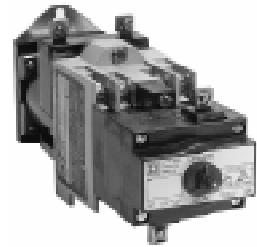

Type XDO40XDL

Normally Open Convertible Instantaneous Contacts	Latching Relay Δ	
	Type	
2	XDO20XDL *	
4	XDO40XDL *	
6	XDO60XDL *	
8	XDO80XDL *	

 File CCN E78403 NKCR
 File Class LR 60905 3211 03

Δ **Caution:** Unlatch coil is rated for intermittent duty and should be connected through a N.O. contact of the relay if the input signal is maintained. Order one more N.O. contact than the application requires to use as a coil clearing contact. If a coil clearing contact is required in series with the latch coil, consult your local Square D field sales office.

DC Utility Relays

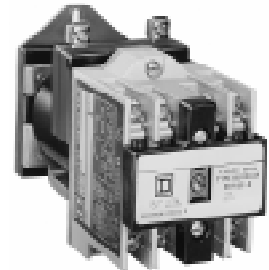

Ideal for utility plant applications where reliable performance and a pure DC power plant are required. In addition to the Type XDO relay features, the Type XUDO provides:

- Up to 12 poles N.O. or N.C.
- Nominal 125VDC coil, capable of handling 140VDC continuously and picking up at 105VDC after having been operated at 140VDC continuously. Other voltages with comparable operating characteristics are available
- Enclosed device capable of operating in 145°F ambient



Type XUDO

Number of Convertible Contacts		Open Type	
N.O.	N.C.	Type	
4	0	XUDO40 *	
0	4	XUDO04 *	
8	0	XUDO80 *	
0	8	XUDO08 *	
12	0	XUDO1200 *	
0	12	XUDO0012 *	

 File CCN E78403 NKCR
 File Class LR 60905 3211 03





















For Replacement Coils Page 6

How to Order:

To Order Specify:	Catalog Number		
• Class Number • Type Number • Voltage Code	Class	Type	Voltage Code
	8501	XDO40	V53

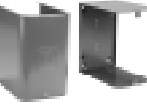

Industrial Control Relays Type X - NEMA Type Relays Accessories, Order Information

	<p>Mechanical Latch Attachment – Mounts on any 2 through 8 pole relay (except XMO master relay). The Type XL and XDL latch attachments are identical in size and mounting provisions. The Type XL AC latch attachment has a continuous-duty-rated coil which is replaceable. The Type XDL DC latch attachment has an intermittent-rated coil (replaceable) and should be connected through a N.O. contact of the basic relay if the input signal is maintained to the unlatch coil.</p> <p>AC Latch Attachment DC Latch Attachment</p>	Class 8501 Type													
	<p>Pneumatic Timer Attachment – Mounts on any 0 through 4 pole AC or DC relay (except XMO master relay). It provides 1 N.O. and 1 N.C. convertible timed contacts, which are the same Type XC-1 cartridges used on the basic relay. Two timing ranges are available, and conversion from On Delay to Off Delay or vice versa is easy.</p> <p>Off Delay 0.2-60 seconds 5-180 seconds</p> <p>On Delay 0.2-60 seconds 5-180 seconds</p>	XTD1 XTD2 XTE1 XTE2	 File E78403 CCN NKCR2  File LR 60905 Class 3211 02												
	<p>Timer Lockout Cover – Fits over the time delay adjustment knob of any Type XT timing attachment. The Lockout Cover is designed to protect the time setting against accidental adjustment. It mounts directly to the timing attachment with two included screws.</p>	XJ1													
	<p>Adder Decks – Adder decks are used to expand the number of poles on a relay. The basic 4 pole relay can be easily converted to an 8 pole or 12 pole relay by installing one or two adder decks. The Class 8501 Type XB20 comes with 2 convertible contact cartridges and will accept 2 additional convertible contact cartridges. The Class 8501 Type XB40 comes with 4 convertible contact cartridges. The same Type XB adder deck is used for both the middle and upper decks of the AC or DC relay.</p> <p>With 2 N.O. contact cartridges With 4 N.O. contact cartridges</p>	XB20 XB40	 File E78403 CCN NKCR2  File LR 60905 Class 3211 02												
	<p>Logic Reed Adder Deck – Used for switching low energy circuits. The Logic Reed Adder Deck is supplied with either one or two logic reed cartridges fixed into the center positions of an adder deck. Contact cartridges are neither convertible nor replaceable. Standard cartridges can be inserted in unused cavities of the Logic Reed Adder Deck. One or two Logic Reed Adder Decks may be added to the basic 4 pole relay. See Application Data on Page 5 for electrical ratings.</p>	<table border="1" style="margin-left: auto; margin-right: auto;"> <tr> <td style="text-align: center;">Number of N.O. Logic Reed Contact Cartridges</td> <td style="text-align: center;">Number of N.C. Logic Reed Contact Cartridges</td> </tr> <tr> <td style="text-align: center;">2</td> <td style="text-align: center;">0</td> </tr> <tr> <td style="text-align: center;">1</td> <td style="text-align: center;">1</td> </tr> <tr> <td style="text-align: center;">1</td> <td style="text-align: center;">0</td> </tr> <tr> <td style="text-align: center;">0</td> <td style="text-align: center;">1</td> </tr> <tr> <td style="text-align: center;">0</td> <td style="text-align: center;">2</td> </tr> </table>	Number of N.O. Logic Reed Contact Cartridges	Number of N.C. Logic Reed Contact Cartridges	2	0	1	1	1	0	0	1	0	2	 File E78403 CCN NKCR2  File LR 60905 Class 3211 02
Number of N.O. Logic Reed Contact Cartridges	Number of N.C. Logic Reed Contact Cartridges														
2	0														
1	1														
1	0														
0	1														
0	2														
	<p>Contact Cartridges – The Type X relay offers 4 Types of contact cartridges. All are color-coded for visual identification of each Type. Note: For additional information regarding contact cartridge see Pages 9-10</p> <p>Standard Cartridge – The standard cartridge, used for most applications, has a black case.</p> <p>Overlapping Cartridge – Same NEMA Type A600 AC rating as standard cartridge and a NEMA Type P150 DC rating. When it is used in the N.O. mode it will close early and when used in the N.C. mode it will open late. If two or more are used together, the N.O. contacts will close before the N.C. contacts open as the relay picks up. Overlap also occurs during dropout. Overlapping cartridge has a red case.</p> <p>May be ordered factory installed: Substitute 1 N.O. and 1 N.C. overlapping cartridges for 2 standard cartridges..... Substitute 2 N.O. and 2 N.C. overlapping cartridges for 4 standard cartridges.</p> <p>Master Cartridge – Features the same contact ratings as the Type XC1 standard cartridge except it has a 20 Ampere continuous current rating instead of 10 Amperes. It can be used in circuits where a master relay is required. Master cartridge has a blue case. Maximum of 6 master cartridges may be used on any 7 and 8 pole AC relays. Do not use any master cartridges on 9-12 pole AC or any DC-operated devices.</p> <p>Logic Reed Cartridge – See Logic Reed Adder Deck above</p>	XC1 XC2 XC4 –	 File E78403 CCN NKCR2  File LR 60905 Class 3211 02												
	<p>Mounting Track – The mounting track has pre-punched mounting holes to simplify mounting the track on the control panel. The relay mounting screws are factory installed on the track so that the relays can be hung prior to tightening the screws.</p> <p>9" long for 4 relays 18" long for 8 relays 27" long for 12 relays 36" long for 16 relays 72" long for 32 relays</p>	XM4 XM8 XM12 XM16 XM32													
	<p>Manual Test Tool – Provides a means of manually switching the contacts of a basic relay or timing relay and holding all contacts in their switched state until the tool is removed. This simplifies the checking of control circuits without power on the coil or contacts.</p>	XA1													
	<p>Transient Suppressor – Consists of an R-C circuit designed to suppress coil generated transients to approximately 200 percent of peak voltage. It is particularly useful when switching the Type X relay near solid state equipment. It is designed for use on coils up to 120VAC.</p>	XS1	 File E78403 CCN NKCR2  File LR60905 Class 321102												
	<p>NEMA Type 1 Enclosure – Formed from sheet steel to provide strength and rigidity. Two conduit knockouts are located in both the top and bottom of the enclosure. The enclosure is furnished with self tapping screws for mounting the relay inside the enclosure. Accommodates a single 4 or 8 pole AC or DC relay, 12 pole AC relay, 4 pole AC latching relay, and 4 pole AC timing relay. NOTE: The 4 pole DC latching relay, 4 pole DC timing relay, 8 pole AC and DC latching relays and 12 pole Utility Auxiliary Relay will not fit.</p>	Class 9991 Type UE7	 File E78403 CCN NKCR												

***Mechanical Latch Attachment Voltage Codes:**

AC Voltages	Code	DC Voltage	Code
24 – 60	V01	6	V50
24 – 50	V12	12	V51 †
120-60/110-50	V02	18	V99
208 – 60	V08	24	V53
240 – 60/220 – 50	V03	48	V56
277 – 60	V04	72	V58
480 – 60/440 – 50	V06	90	V59
600 – 60/550 – 50	V07	115/125	V62
		230/250	V66

† Specify voltage on order.

For Replacement Coils Page 6

How to Order:

To Order Specify:	Catalog Number				
<ul style="list-style-type: none"> • Class Number • Type Number • Voltage Code for mechanical latch attachment • Form for factory installed overlapping contacts 	<table style="width: 100%; border-collapse: collapse;"> <tr> <td style="width: 50%; text-align: center;">Class</td> <td style="width: 50%; text-align: center;">Type</td> </tr> <tr> <td style="text-align: center;">8501</td> <td style="text-align: center;">XTE1</td> </tr> </table>	Class	Type	8501	XTE1
Class	Type				
8501	XTE1				



Industrial Control Relays Type X — NEMA Type Relays Application Data

Average Operating Times In Milliseconds

Device	Pick-Up	Drop-Out
AC Relay	15	16
AC Latching Relay	15	13
DC Relay	37	21
DC Latching Relay	37	45

Voltage Range: AC operation, +10/-15%
DC operation, +10/-20%

In the case of dual rated DC coils, the range is +10% of the larger number and -20% of smaller number.

Operating Temperature Range:

-40°C to +71°C
(-40°F to +160°F)

Contact Ratings

Type of Cartridge	AC Ratings								DC Ratings						
	Volts	NEMA Rating	Inductive 35% Power Factor				Resistive 75% Power Factor	Volts	Inductive			Resistive			
			Make		Break				Continuous Amperes	Make, Break and Continuous Amperes	NEMA Rating	Max. Make and Break Amperes (138VA Max. for 300 V or Less)	Continuous Amperes	Make and Break Amperes	Continuous Amperes
Standard	120 240 480 600	A600	60 30 15 12	7200 7200 7200 7200	6 3 1.5 1.2	720 720 720 720	10 10 10 10	10 10 10 10							
Overlapping	600		12	7200	1.2	720	10	10	125	P150	1.1	5	4	5	
Master *	-	A600	Same as standard cartridge above except substitute 20 Ampere for the continuous Ampere rating					125 250 301-600	P600	1.1 0.55 0.20	5 5 5	4 0.8 -	5 5 -		
Logic Reed	-	-	150VAC, 150MA, 8W Maximum					-	-	-	-	30VDC, 60MA			

* Maximum of six 8501 Type XC – 4 Master Cartridges may be used on any 7 and 8 pole AC device. Do not use any Master Cartridges on 9-12 pole AC or any DC-operated relays.

Contact Arrangement

The following tables list all pole arrangements and the location of the N.O. and N.C. poles. Relays purchased from the factory will correspond to these tables. For example: an XO12 will have one N.O. pole in position 1; positions 2 and 3 will have N.C. poles; position 4 will be a space.

Note: Note: For additional information regarding contact cartridges see Pages 9 and 10.

2, 3, and 4 Pole Relay – All contacts convertible

No. of Poles	Type	Pole Number †			
		1	2	3	4
2	XO20	S	O	O	S
	XO11	S	O	1	S
	XO02	S	1	1	S
3	XO30	O	O	O	S
	XO21	O	1	O	S
	XO12	O	1	1	S
	XO03	1	1	1	S
4	XO40	O	O	O	O
	XO31	O	1	O	O
	XO22	O	1	1	O
	XO13	O	1	1	1
XO04	1	1	1	1	

6 and 8 Pole Relay – All contacts convertible

No. of Poles	Type	Pole Number †				No. of Poles	Type	Pole Number †			
		5	6	7	8			5	6	7	8
6	XO60	S	O	O	S	8	XO80	O	O	O	O
		O	O	O	O			O	O	O	O
	XO51	S	O	O	S		XO71	O	1	O	O
		O	1	O	O			O	O	O	O
	XO42	S	O	O	S		XO62	O	1	1	O
		O	1	1	O			O	O	O	O
	XO33	S	1	1	S		XO53	O	1	O	O
		O	1	O	O			O	1	1	O
	XO24	S	1	1	S		XO44	O	1	1	O
		O	1	1	O			O	1	1	O
XO15	S	1	1	S	XO35	O	1	1	1		
	O	1	1	1		O	1	1	O		
XO06	S	1	1	S	XO26	O	1	1	O		
	1	1	1	1		1	1	1	1		
					XO17	O	1	1	1		
					XO08	1	1	1	1		

10 and 12 Pole Relay – All contacts convertible

No. of Poles	Type	Pole Number †				No. of Poles	Type	Pole Number †			
		9	10	11	12			9	10	11	12
10	XO1000	S	O	O	S	12	XO1200	O	O	O	O
		O	O	O	O			O	O	O	O
	XO0901	S	O	O	S		XO1101	O	1	O	O
		O	1	O	O			O	O	O	O
	XO0802	S	O	O	S		XO1002	O	1	1	O
		O	1	1	O			O	O	O	O
	XO0703	S	O	O	S		XO0903	O	1	1	O
		O	1	1	O			O	O	O	O
	XO0604	S	O	O	S		XO0804	O	1	1	O
		O	1	1	O			O	1	1	O
XO0505	S	O	O	S	XO0705	O	1	1	O		
	O	1	1	O		O	1	O	O		
XO0406	S	1	1	S	XO0606	O	1	1	O		
	O	1	1	O		O	1	1	O		
XO0307	S	1	1	S	XO0507	O	1	1	O		
	O	1	1	O		O	1	1	O		
XO0208	S	1	1	S	XO0408	O	1	1	O		
	O	1	1	O		O	1	1	O		
		1	1	1		1	1	1	1		

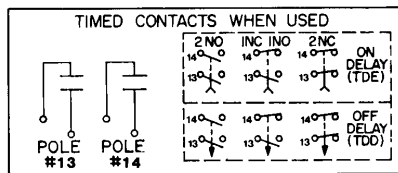
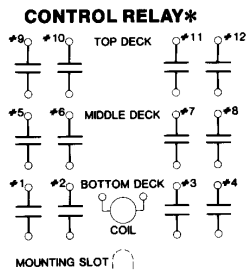

XTD & XTE Timer Attachments – All Contacts Convertible

No. of Timed Contacts	Type	Pole Number †	
		13	14
2	XTD XTE	O	1

† O – Normally Open Contact 1 – Normally Closed Contact S – Space for Future Contact



Industrial Control Relays Type X — NEMA Type Relays Application Data

Replacement AC Magnet Coils For Relays

Equipment to be serviced			Coil Prefix or Class and Type	Hz	Suffix Number (Complete Coil Number consists of Prefix or Class and Type followed by Suffix Number)											Coil Volt-Amperes		
Class	Type	Poles			24 Volts	110-115 Volts	120 Volts	208 Volts	220 Volts	240 Volts	277 Volts	380 Volts	440 Volts	480 Volts	550 Volts	600 Volts	Inrush	Sealed
8501	X	All	9998-X	60 50	23 24	— 44	44 —	51 52	52 53	53 —	55 —	— —	— 62	62 —	— 65	65 —	148 143	23 25

Replacement DC Magnet Coils For Relays

Equipment to be serviced			Coil Prefix or Class and Type	Suffix Number (Complete Coil Number consists of Prefix or Class and Type followed by Suffix Number)												Coil Burden Watts	
Class	Type	Poles		6 Volts	12 Volts	18 Volts	24 Volts	32 Volts	48 Volts	64 Volts	72 Volts	90 Volts	110 Volts	115/125 Volts	220 Volts		230/250 Volts
8501	XD	All	9998 XD	19	28	34	37	40	46	49	52	55	—	58	—	67	18
	XDL	—	9998 XDL	19B	28B	34B	37B	40B	46B	49B	52B	55B	—	58B	—	67B	50
	XUD	All	9998 XUD	19	28	—	37	—	46	—	—	—	—	58*	—	67*	16



Industrial Control Relays

Type X — NEMA Type Relays

Application Data

Definition of Ratings

Control relays are designed for switching inductive and resistive loads in both AC and DC circuits. By far, the greatest number of applications involve the switching of inductive loads in AC circuits. Typical loads include solenoids and operating coils of such devices as other relays, timers, starters and contactors.

The magnets on AC devices exhibit an inrush current when first switched on, with the current subsiding to some lesser value, known as the sealed current, after the magnet has moved to its sealed position. DC devices do not have an inrush current when first energized. Relay contacts may also be called upon to carry current continuously for long periods of time. This has resulted in recognizing three important ratings for relay contacts: the *make rating*, *break rating* and the *continuous current rating*. In addition, ratings are further divided into categories which depend upon whether the load is resistive or inductive in nature.

Contact Ratings

Contact Ratings on page 5 shows current and VA (volt-ampere) values in sufficient detail for most applications. A short definition of some of the terms used in the table follow:

- **Resistive Rating** - Indicates the resistive load that the contacts can make, break or carry continuously. Resistive ratings are based on a 75% power factor.
- **Inductive Rating** - Refers to loads such as coils of contactors, starters and relays and solenoids that contacts can make, break and carry continuously. Inductive rating tests are run with 35% power factor load.
- **Make Rating** - Applies to the current that can be handled by the contact at the time of contact closure. In inductive AC circuits, the momentary inrush current is often 10 times the sealed current, and a relay must be able to handle this inrush current as well as be able to break it in an emergency. The endurance test listed in NEMA Standard ICS 5-1993 Paragraph 8 requires relay contacts to make the make rating for 6,000 operations.
- **Break Rating** - Refers to the current that can be interrupted successfully by the contact. The inductive break rating is always less than the resistive or continuous ratings. When contacts break an inductive circuit, the inductance of the load tends to maintain the current. The result is an arc across the contacts which causes heating and erosion of the contacts. Because of the extra heat generated, the allowable inductive current must be less than the resistive current for equal contact life. The endurance test from NEMA Standard ICS 5-1993 Paragraph 8 requires relay contacts to interrupt the break rating for 6,000 operations. It also requires relay contacts to interrupt the make rating for 6 operations in an emergency.
- **Continuous Rating** - Continuous rating indicates the load that the contacts can carry continuously without making or breaking the circuit and without exceeding a certain temperature rise.

Contact Life

The life of control relay contacts depends upon the magnitude and characteristics of the electrical load, inductance, duty cycle, mechanical properties of the device in which they are used, voltage fluctuations, environment, etc. The Class 8501 Type X relay carries a NEMA A600 rating. NEMA A600 relays have 600 VAC spacings, a 10 ampere *continuous rating*, a 60 ampere *make rating*, and a 6 ampere *break rating* at 120 volt AC for an AC inductive load.

When control circuit relays are operated at maximum rated load, the life of the contact is usually less than that of the mechanical life of the device. If the application requires a large number of operations during the life of the contacts, the contacts must be applied at values less than their maximum make and break ratings. NEMA Standard ICS 5-1993 Paragraph 8 recommends that control relays for automatically-operated sequencing systems be utilized with loads of less than 25% of the 60 ampere make and 6 ampere break ratings. It does not recommend using a relay at its maximum ampere rating where the number of operations are expected to substantially exceed the 6000 operations required by the endurance test in NEMA Standard ICS 5-1993 Paragraph 8.

Life-Load Guide

The information shown is provided to *estimate* the service life of a Class 8501 Type X control relay. This information is *not to be taken as a guarantee*, but rather an approximate life expectancy. The information is based on the following:

- Operating 40 hours per week
- Operating 52 weeks per year
- Inrush and continuous current ratings not exceeded
- Application in usual service conditions (such as described in NEMA Standard ICS 1-1993 Paragraph 6)
- Operating at 120 Volts 60 Hertz

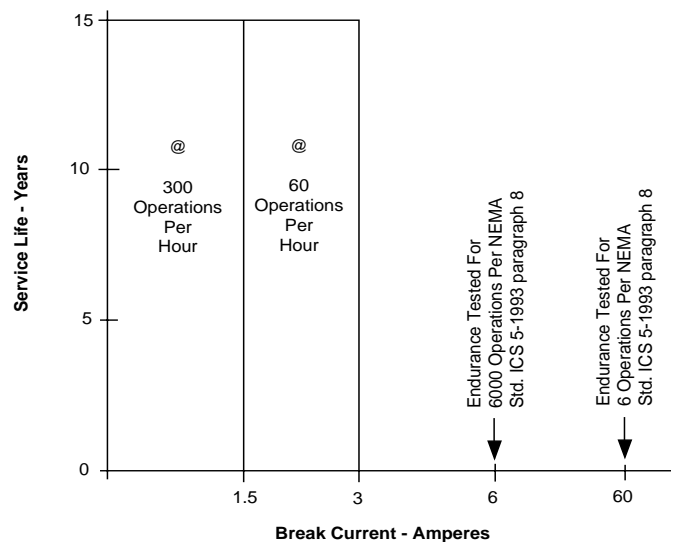

Figure 1: Service Live vs. Break Current



Isolation

The class 8501 Type X relay has electrical clearances for up to 600 volts. All contacts are single-throw double-break contacts and are completely isolated from one another. This means that different contacts on the same relay may be connected to control circuits having different voltage values. It also means that if different contacts are connected to different sources, polarity on adjacent connections need not be the same. Electrical spacings per UL 508:

- Of not less than 3/8" (9.5mm) through air and 1/2" (12.7mm) over the surface of insulating material are maintained between uninsulated live parts and an uninsulated ground part other than the enclosure, or exposed metal part.
- Of not less than 1/2" (12.7mm) measured over the shortest distance are maintained between any uninsulated live part and the walls of a metal enclosure, including fittings for conduit or armored cable.

Contact Cartridge Construction

Each contact on the Type X relay is a double-break contact. This places, for practical purposes, two single-break contacts in series so that two arcs occur when the contact interrupts the current flow. This division of energy in the arc materially extends the electrical life of the contact when compared to devices employing single-break contacts. The stationary and movable contacts are made of silver-cadmium-oxide. This choice of material is important because of its resistance to welding when closing on the inrush currents normally associated with inductive loads. It also helps to reduce contact erosion which occurs with repeated interruption of inductive loads. The movable contact is split down the center to provide two parallel paths per pole. The fact that both halves of the movable contact are rigidly connected assures that all four contact points will be held closed with nearly equal force. In addition, a conductive bridge straddles the two fingers to provide a cross-over path for even greater contact reliability.

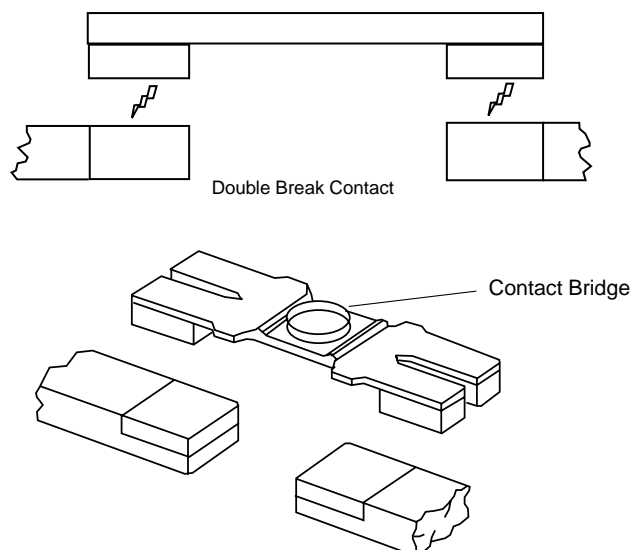

Figure 2: Movable Contact

The construction of the cartridges is such that, with the relay mounted in the normal manner, external dust is virtually prevented from entering in to the contact area. A glass-filled thermoplastic is used for the contact carrier in the cartridge. This material was selected because of its ability to withstand high operating temperatures and its low wear rate. The plug-in interface between the relay terminals and the cartridges consist of fine silver which, under pressure, assures a reliable connection. The force of the connection is in excess of one pound.

Contact Cartridge Types and Color Codes

Four types of contact cartridges are available for use with the Type X relay: standard contact cartridge which is **black**, overlapping contact cartridge which is **red**, logic reed contact cartridge which is **grey (only available when ordered as a Class 8501 Type XBR adder deck)** and the master contact cartridge which is **blue**. All are the same size and color coded for visual identification. In addition, the normally open contact symbol —| appears on a green background and the normally closed symbol —|/ appears on a yellow background. This color coded scheme is consistent throughout the Type X product offering.

A. Standard Contact Cartridge

Standard Type X relay contact cartridges are designed so that there is a mechanical differential between normally open and normally closed contacts mounted in the same relay. This means that the normally closed contacts open substantially before the normally open contacts close during the stroke of the relay. This non-overlapping also takes place during the drop-out of the relay. The standard cartridge, used in most applications, has a black case. It is rated NEMA A600 for AC applications and NEMA P600 for DC applications.

B. Overlapping Contact Cartridge

There are certain cases where an intentional overlap is desired, and an optional contact has been designed for these purposes. The overlapping contact cartridge, which has a red case, has the same NEMA A600 AC contact rating as the standard cartridge and a NEMA P150 DC rating.

When an overlapping contact cartridge is inserted into the relay as a normally open contact, it will close sooner (early closing contact) in the stroke of the relay than a standard contact. If it is inserted as a normally closed contact, it will open later (late opening contact) in the stroke of the relay than a standard contact.

When two such contacts are used in conjunction with one another, they will produce an output signal to the load which is originated through the normally closed contact and maintained through the normally open contact after the relay has picked up. The overlap feature prevents dropout of the load during the transfer from the pickup to the dropout circuit.



Industrial Control Relays

Type X — NEMA Type Relays

Product Data

Contact Cartridge Types and Color Codes con't.

See below for illustration of a typical application with two limit switches, LS1 and LS2. The machine is such that LS2 is closed to pick up CR1 but, because of the cam limitations, LS2 opens before the dropout of the relay is desired. Assuming that the dropout of the relay can be performed by the opening of LS1, we have a natural application for overlapping contacts.

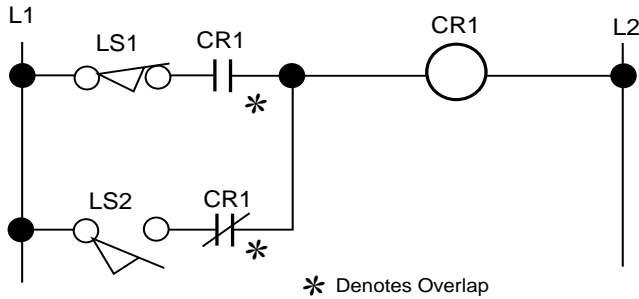

Figure 3: Overlapping Contact Application

C. Logic Reed Contact Cartridge

The logic reed contact cartridges are available only in the logic reed adder deck. The contact cartridges are permanently fixed within the center positions of the adder deck and can not be converted or changed in position. The adder decks are available in a combination of normally open or normally closed contacts. The outside positions of the adder deck can be filled with any other type of cartridge available in the Type X contact cartridge line. The adder deck can be added to any 0-8 pole AC or DC relay.

A logic reed cartridge consists of a magnetic reed switch mounted in the plug in-cartridge housing in place of the standard silver-cadmium-oxide contacts. It is used for improved contact reliability when switching low-energy circuits. Logic reed cartridges are rated 150 VAC (8W maximum) or 60 milliamperes and 30 VDC and are for use on resistive loads only. These cartridges are identified by a gray housing. The reed switch mounted within the cartridge housing consists of four basic components: glass capsule, gas (atmosphere within the glass capsule), contacts (reeds) and leads. The reeds are hermetically sealed into the glass capsule in cantilever fashion so that the ends align and overlap – but with a small gap. When the reeds are brought into the influence of a magnetic field, they are attracted to one another and make

contact. In the case of a normally open logic reed contact, this occurs when the relay coil is energized and the magnet carrier moves down, bringing the magnet close enough to close the contacts. The contact ratings of the logic reed cartridge are specified as maximum wattage, maximum voltage, and maximum switched current. The maximum voltage times the maximum switched current *cannot* exceed the maximum wattage.

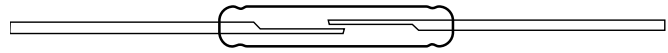

Figure 4: Logic Reed Construction

D. Master Contact Cartridge

Master contact cartridges, which have a blue case, feature a 20 ampere AC continuous current rating instead of 10 amperes. Their AC make and break rating remain 7200VA and 720VA respectively. The master contact cartridge can be used in circuits where a master relay is required. Under normal operating conditions, the master contacts are rated to carry the total continuous current of all the loads in the circuit. They do not make or break this current except in an emergency. In an emergency situation, master contacts can interrupt their break rating 6,000 operations and interrupt their make rating for 6 operations. This is in accordance with NEMA Standard ICS 5-1993 Part 2.

Note: A maximum of 6 master cartridges may be used on a 7 or 8 pole AC device. Do not use any master cartridges on 9-12 pole AC or and DC-operated relays.

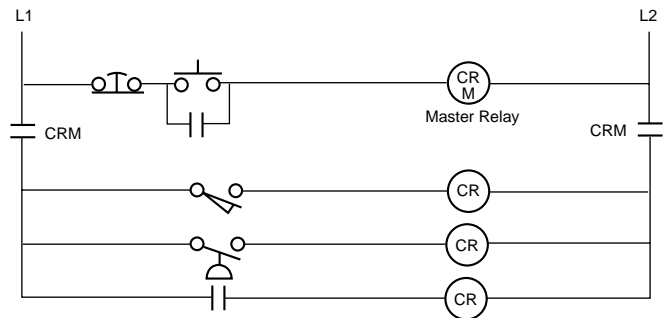

Figure 5: Master Relay Circuit

Note: For additional product data regarding the Class 8501 Type X Relay request Product Data Report M-623.



Industrial Control Relays Type X — NEMA Type Relays Dimensions, Shipping Weights

AC Control Relay

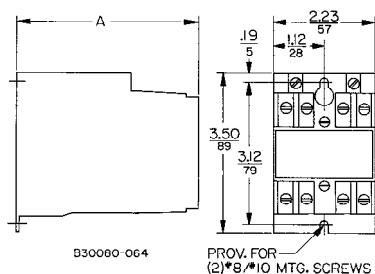

No. of Poles	"A" Dim.		Shipping Weight Lbs.
	IN	mm	
0-4	3.95	100	2.0
6-8	5.16	131	2.3
10-12	6.36	162	2.7

DC Control Relay, Utility Auxiliary Relay

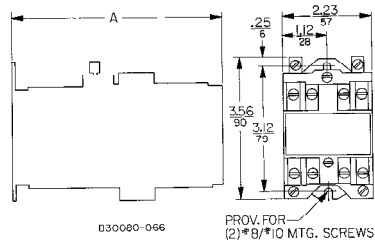

No. of Poles	"A" Dim.		Shipping Weight Lbs.
	IN	mm	
0-4	5.17	131	3.1
6-8	6.37	162	3.4
10-12	7.57	193	3.8

AC Latching Relay

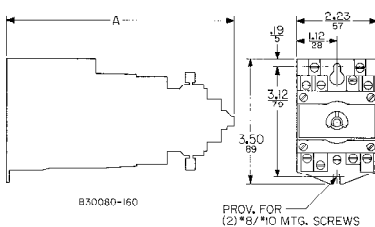

No. of Poles	"A" Dim.		Shipping Weight Lbs.
	IN	mm	
2-4	6.54	166	2.8
6-8	7.74	197	3.1

DC Latching Relay

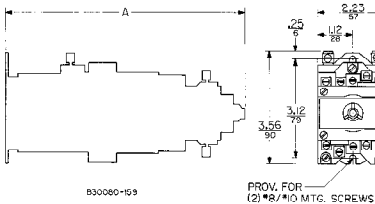

No. of Poles	"A" Dim.		Shipping Weight Lbs.
	IN	mm	
2-4	7.76	197	3.9
6-8	8.96	228	4.2

AC Timing Relay

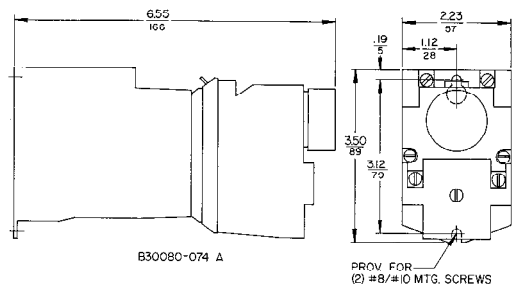

DC Timing Relay

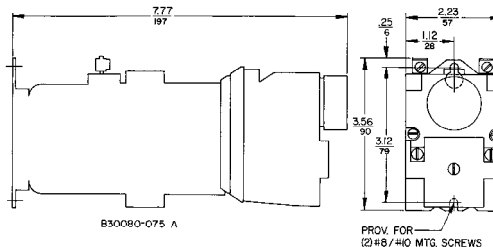

Type X Relay Mounting Track

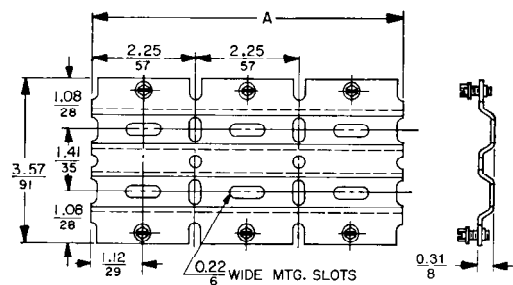

No. of Relays	"A" Dim.		Shipping Weight Lbs.
	IN	mm	
4	9	229	0.75
8	18	457	1.5
12	27	686	2.25
16	36	914	3.0
32	72	1828	6.0

NEMA 1 Enclosure Class 9991 Type UE-7

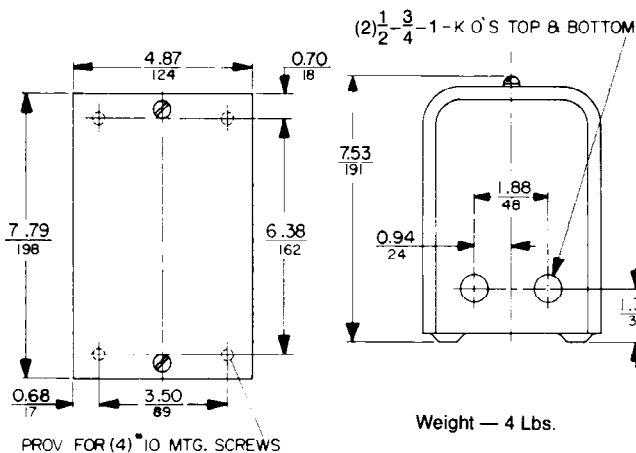

Dimensions Inches
MM



SQUARE D

Square D Company
P.O. Box 27446
Raleigh, N.C. 27611, USA

 is a registered trademark of Underwriter's Laboratories.
UL is a registered trademark of Underwriter's Laboratories.
CSA is a registered trademark of Canadian Standard Association.