

Your Global Automation Partner

TURCK

Mil-Spec Connectors Design Guide



A Global Leader in Industrial Automation

Turck's sensors, connectivity, and fieldbus technology products are built to be the best. As one of the most **prominent** sensor manufacturers **in the world**, we even back our sensors with a **lifetime warranty**. Turck works by bringing **rugged engineering** solutions to your industrial automation applications.

85,000+
SOLUTIONS

50+
YEARS OF INNOVATION

2,000+
EXPERIENCED SALES REPRESENTATIVES

Pioneer in non-contact
sensing technology

Developed innovative **connectivity**
solutions in response to our sensor customer needs

Recognized need and advanced knowledge of harsh duty
environments lead to **I/O solutions**

**SUPPORT &
DEDICATED SERVICE**

EXTENSIVE WARRANTY



4,000+
APPLICATION EXPERTS

RESPOND and SOLVE over **1,200** inquiries per day



Strategically placed manufacturing facilities in the

USA with **28** GLOBAL SUBSIDIARIES

GLOBAL BUT LOCAL...

60 representations worldwide



Contents

06 Mil-Spec Connectors

07 The Turck Solution

08 Threaded

22 Bayonet

32 Reverse Bayonet

48 Bulk Cable

74 Glossary

76 Warranty Terms
and Conditions



Mil-Spec Connectors

Originally, connectors that met military specifications—also known as Mil-Spec connectors—were created to ensure they met the toughest of requirements. It was quickly realized that these strict Mil-Spec standards produced products that are an ideal fit for rugged applications in areas such as automotive, mobile equipment, and oil and gas applications among many more. Connectors that meet the Mil-Spec requirements provide a robust, versatile solution for all applications, even in harsh environments.



Dirt



Water



Temp



Wind



Snow





Vibration



Impact

The Turck Solution

Turck's connectivity and molding manufacturing experience has allowed us to create an overmold process that allows a superior seal between the cable and connector, protecting against ingress susceptibility. Traditional assembled Mil-Spec connectors come as an arrangement of components that require assembling and hand wiring before they can be used. This increases chances for mis-wiring and incurs high labor costs. With Turck's Mil-Spec cordsets, you receive a fully assembled and overmolded product that is 100% factory tested and ready to plug into your application.

Threaded	Bayonet	Reverse Bayonet
		
<p>Full Thread 109 Connector Inserts Up to 28 Pins 8-24 AWG Conductors High Power Options Combined Power and Signal Environmentally Sealed</p>	<p>Quick Connect 42 Connector Inserts Up to 32 Pins 12-24 AWG Conductors Ideal for High Vibration High Density Options Environmentally Sealed</p>	<p>Quick Connect 129 Connector Inserts Up to 28 Pins 8-24 AWG Conductors Ideal for High Vibration Combined Power and Signal Environmentally Sealed</p>

What Makes Turck Work?

Ingress Protection

Our Mil-Spec cordsets have been tested in accordance to meet IEC 60529 IP67 and IP68, which requires the product to remain fully functional after being submerged in 6 feet of water for 24 hours.

Harsh Environment Protection

To ensure reliability in applications involving snow, dirt, and wind, we tested our Mil-Spec products to NEMA 6P. These standards ensure protection against falling dirt, temporary submersion in water, incidental contact, and the external formation of ice on the cordset.

Robust

Turck Mil-Spec cordsets also undergo straight and right angle pull testing. This ensures our products exceed industry standards, resulting in a product built to thrive in the harshest of applications.

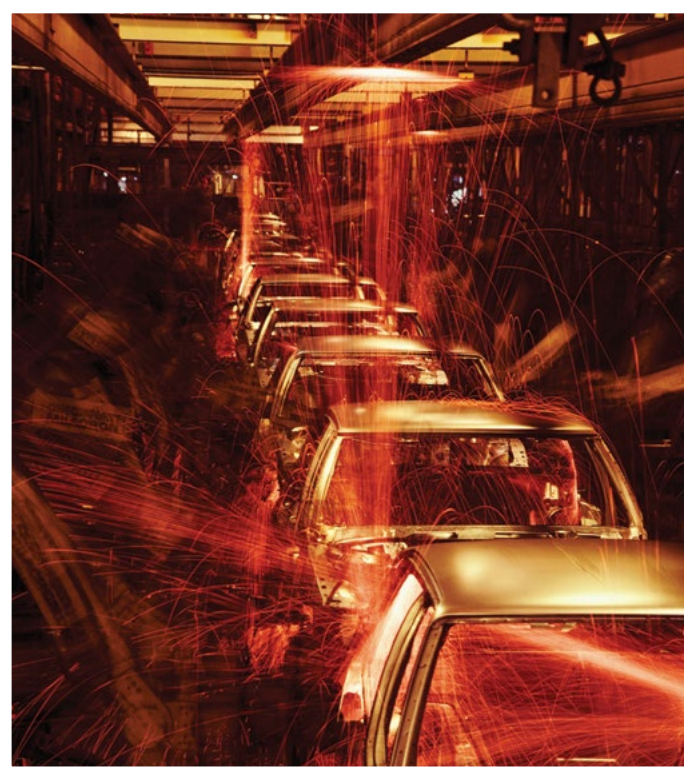
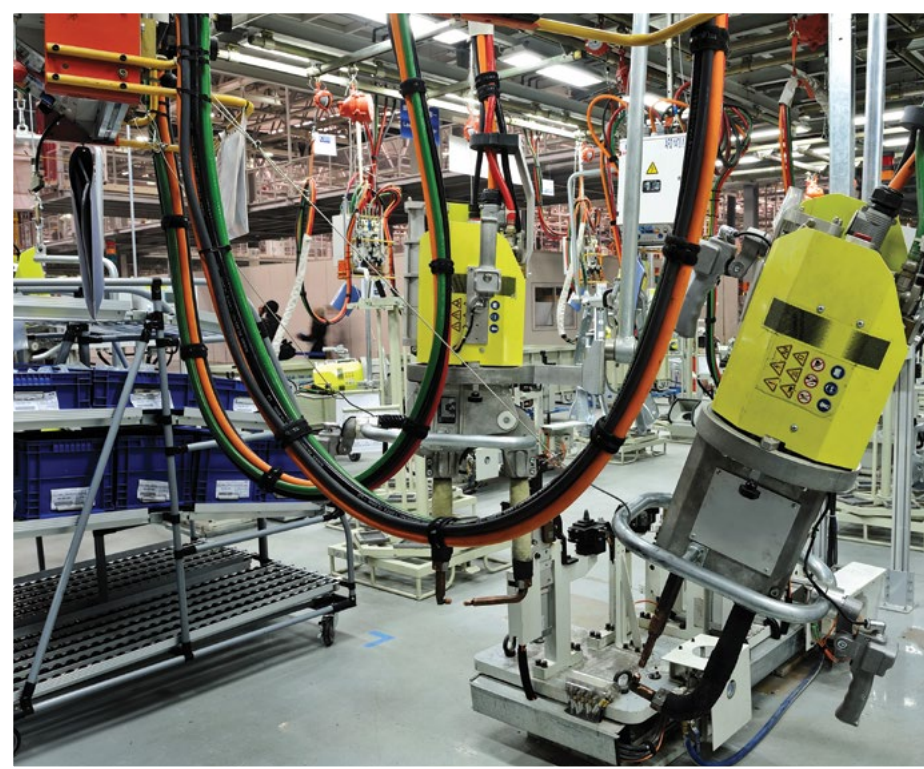

Threaded

Turck's overmolded MIL-DTL-5015 threaded style connectors offer a fully threaded, tight connection that is ideal for commercial applications. These connectors are available in a variety of shell sizes, number of contacts and layouts. Overmolded Mil-Spec connectors provide a reduction in labor over traditional field-assembled connectors and diminish the risk of mis-wiring by providing a complete overmolded cordset assembly, allowing you to decrease downtime and save money. Turck's overmold design technology provides the flexibility to seal the connectors to a wide variety of different cable types. The threaded style connector is an ideal option for industrial applications, including robotics, machine tools and welding. Variations in contact layouts allow for just power, just signal or a mix of both contact types.

Applications:

- Conveyors
- Ships
- Trucks
- Trailers
- Encoders and other instrumentation
- Industrial machinery
- Factory automation
- Communications systems



Variety of cable options available

Fully threaded for tight seal

Eyelet for closure cap lanyard

Meets NEMA 1, 3, 4, 6P and IEC IP67, IP68 rated

Provides more options for power applications

Shell sizes 8-24

Threaded Technical Specifications

Mechanical

Mold material/Color:	PVC/Black
Contact carrier material:	Neoprene
Coupling nut material/Plating:	Aluminum alloy/Olive drab chromate
Mold sleeve material/Plating:	Aluminum/Black anodized
Environmental protection:	NEMA 1, 3, 4, 6P IEC IP67, IP68
Temperature rating:	From -60 °C to 105 °C (-76 °F to 221 °F)
Contact sizes:	Contact size 16 accommodates wire sizes 16-24 AWG Contact size 12 accommodates wire sizes 12-14 AWG Contact size 8 accommodates wire sizes 8-10 AWG

Electrical

Contact material/Plating:	Copper alloy/Silver
Current:	Up to 44 amps
Voltage:	Up to 600 volts
Wire range sizes:	12 to 24 AWG
Number of circuits:	1 to 28

Threaded Overmolded Cordset Part Number Guide

Threaded MIL-DTL-5015

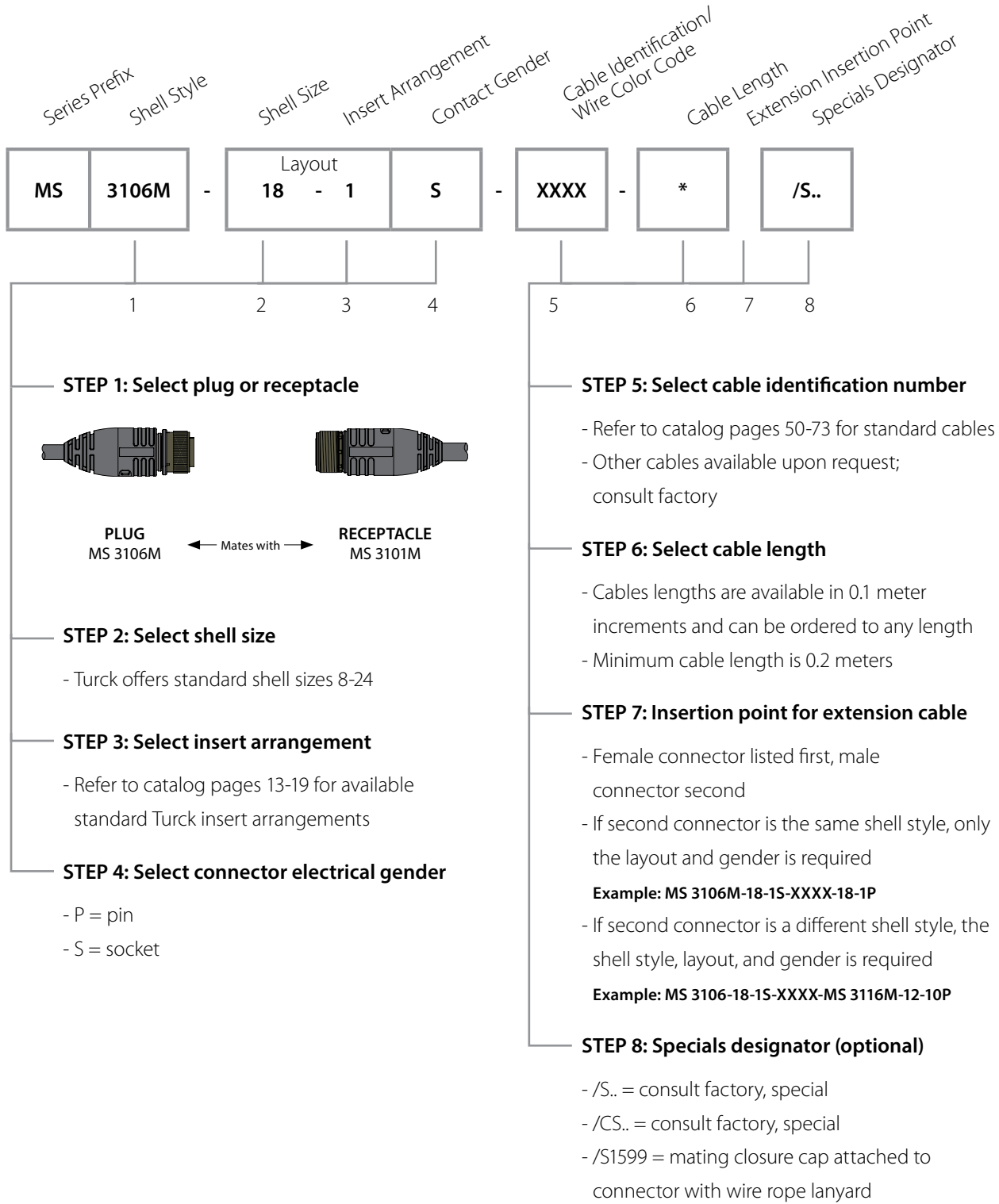

Part Number Keys are to assist in identification only. Not all configurations may be available. Consult factory for product availability.

Threaded Receptacle Part Number Guide

Threaded MIL-DTL-5015

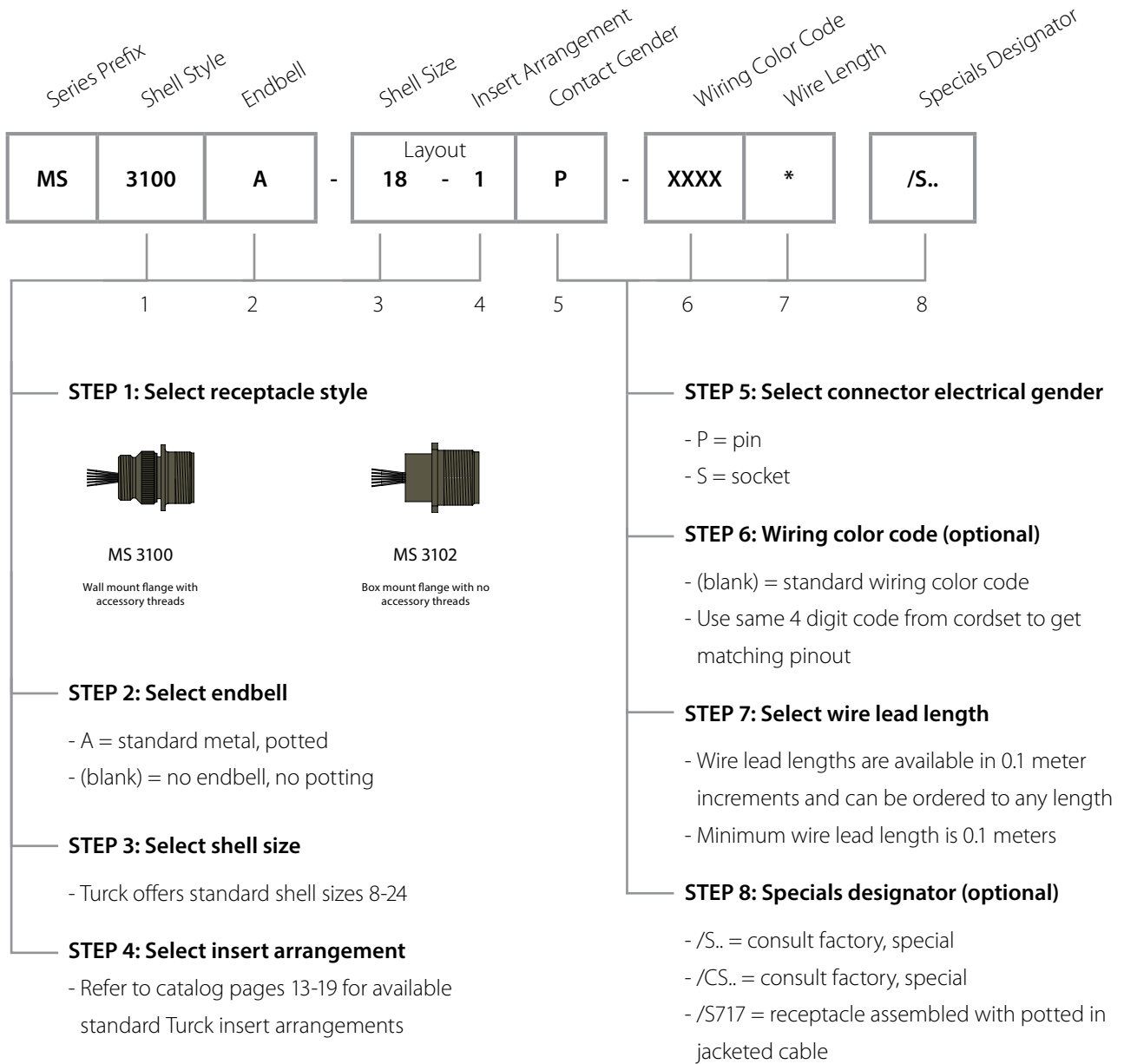

Part Number Keys are to assist in identification only. Not all configurations may be available. Consult factory for product availability.

Threaded Style Insert Arrangements

LAYOUT	TOTAL CONTACTS	CONTACT SIZES (AWG)			PAGE NUMBER
		8-10	12-14	16-20	
8S-1	1			1	16
10S-2	1			1	16
12S-4	1			1	16
12-5	1		1		16
14S-4	1			1	16
14-3	1	1			16
16S-3	1			1	16
16-2	1		1		16
18-7	1	1			17
18-16	1		1		17
10SL-4†*	2			2	16
12S-3*	2			2	16
14S-9*	2			2	16
16S-4	2			2	16
16-11	2		2		16
18-3	2		2		16
20-23	2	2			18
22-1	2	2			18
22-8	2		2		18
22-11	2			2	18
10SL-3	3			3	16
14S-1	3			3	16
14S-7	3			3	16
14S-12	3			3	16
16S-5	3			3	16
16S-6	3			3	16
16-7	3	1		2	16
16-10	3		3		16
18-5	3		2	1	16
18-22	3			3	17
20-3	3		3		17
20-6	3			3	17
20-19	3	3			17
22-2	3	3			18
22-6	3	2		1	18
22-9	3		3		18
14S-2*	4			4	16
14S-10	4			4	16
16-9	4		2	2	16
18-4*	4			4	16

† 10SL-4 arrangement available only with pin contacts in receptacle and socket contacts in plug

* Indicates standard connector

We reserve the right to make technical alterations without prior notice.

Threaded Style Insert Arrangements

LAYOUT	TOTAL CONTACTS	CONTACT SIZES (AWG)			PAGE NUMBER
		8-10	12-14	16-20	
18-10*	4		4		17
18-13	4	1	3		17
20-4*	4		4		17
20-24	4	2		2	18
22-4	4	2	2		18
22-10	4			4	18
22-22*	4	4			18
24-22*	4	4			19
14S-5*	5			5	16
16S-8*	5			5	16
18-11*	5		5		17
18-20	5			5	17
18-29	5			5	17
18-30	5			5	17
18-31	5			5	17
20-14	5	2	3		17
22-12	5	2		3	18
22-13	5		4	1	18
22-34	5		3	2	19
24-17	5		2	3	19
14S-6*	6			6	16
18-12	6			6	17
20-8	6	2		4	17
20-17	6		5	1	17
20-22	6	3		3	18
22-5	6		2	4	18
22-15	6		5	1	18
22-24	6		2	4	18
16S-1*	7			7	16
18-9	7		2	5	17
18-17	7		2	5	17
20-15*	7		7		17
22-28	7		7		19
22-33	7			7	19
24-2	7		7		19
24-3	7		2	5	19
24-10	7	7			19
24-16	7	1	3	3	19
24-27	7			7	19
18-8*	8		1	7	17

* Indicates standard connector

We reserve the right to make technical alterations without prior notice.

Threaded Style Insert Arrangements

LAYOUT	TOTAL CONTACTS	CONTACT SIZES (AWG)			PAGE NUMBER
		8-10	12-14	16-20	
20-7*	8			8	17
20-9	8		1	7	17
22-18	8			8	18
22-23	8		8		18
24-6	8		8		19
20-16	9		2	7	17
20-18*	9		3	6	17
20-21	9		1	8	17
22-16	9		3	6	18
22-17	9		1	8	18
22-20	9			9	18
22-27	9	1		8	18
24-11	9	3	6		19
18-1*	10			10	16
18-19	10			10	17
18-24	10			10	17
24-21	10	1		9	19
20-33	11			11	18
24-20	11		2	9	19
20-11	13			13	17
20-25	13			13	18
20-30	13			13	18
20-27*	14			14	18
22-19*	14			14	18
24-5	16			16	19
24-7*	16		2	14	19
20-29*	17			17	18
22-14*	19			19	18
24-28*	24			24	19

We reserve the right to make technical alterations without prior notice.

* Indicates standard connector

Threaded Style Insert Arrangements

FRONT FACE OF PIN INSERTS ILLUSTRATED

Shell Size/Layout	8S-1	10S-2	10SL-3	10SL-4*	12S-3*	12S-4	12-5
Number of Contacts/Size	1-#16	1-#16	3-#16	2-#16	2-#16	1-#16	1-#12

Shell Size/Layout	14S-1	14S-2*	14S-4	14S-5*	14S-6*	14S-7	14S-9*
Number of Contacts/Size	3-#16	4-#16	1-#16	5-#16	6-#16	3-#16	2-#16

Shell Size/Layout	14S-10	14S-12	14-3	16S-1*	16S-3	16S-4
Number of Contacts/Size	4-#16	3-#16	1-#8	7-#16	1-#16	2-#16

Shell Size/Layout	16S-5	16S-6	16S-8*	16-2	16-7	16-9
Number of Contacts/Size	3-#16	3-#16	5-#16	1-#12	1-#8, 2-#16	2-#12, 2-#16

Shell Size/Layout	16-10	16-11	18-1*	18-3	18-4*	18-5
Number of Contacts/Size	3-#12	2-#12	10-#16	2-#12	4-#16	2-#12, 1-#16

* Indicates standard connector

Threaded Style Insert Arrangements

FRONT FACE OF PIN INSERTS ILLUSTRATED

Shell Size/Layout	18-7	18-8*	18-9	18-10*	18-11*	18-12
Number of Contacts/Size	1-#8	1-#12, 7-#16	2-#12, 5-#16	4-#12	5-#12	6-#16

Shell Size/Layout	18-13	18-16	18-17	18-19	18-20	18-22
Number of Contacts/Size	1-#8, 3-#12	1-#12	2-#12, 5-#16	10-#16	5-#16	3-#16

Shell Size/Layout	18-24	18-29	18-30	18-31	20-3	20-4*
Number of Contacts/Size	10-#16	5-#16	5-#16	5-#16	3-#12	4-#12

Shell Size/Layout	20-6	20-7*	20-8	20-9	20-11	20-14
Number of Contacts/Size	3-#16	8-#16	2-#8, 4-#16	1-#12, 7-#16	13-#16	2-#8, 3-#12

Shell Size/Layout	20-15*	20-16	20-17	20-18*	20-19	20-21
Number of Contacts/Size	7-#12	2-#12, 7-#16	5-#12, 1-#16	3-#12, 6-#16	3-#8	1-#12, 8-#16

* Indicates standard connector

Threaded Style Insert Arrangements

FRONT FACE OF PIN INSERTS ILLUSTRATED

Shell Size/Layout	20-22	20-23	20-24	20-25	20-27*	20-29*
Number of Contacts/Size	3-#8, 3-#16	2-#8	2-#8, 2-#16	13-#16	14-#16	17-#16

Shell Size/Layout	20-30	20-33	22-1	22-2	22-4	22-5
Number of Contacts/Size	13-#16	11-#16	2-#8	3-#8	2-#8, 2-#12	2-#12, 4-#16

Shell Size/Layout	22-6	22-8	22-9	22-10	22-11	22-12
Number of Contacts/Size	2-#8, 1-#16	2-#12	3-#12	4-#16	2-#16	2-#8, 3-#16

Shell Size/Layout	22-13	22-14*	22-15	22-16	22-17	22-18
Number of Contacts/Size	4-#12, 1-#16	19-#16	5-#12, 1-#16	3-#12, 6-#16	1-#12, 8-#16	8-#16

Shell Size/Layout	22-19*	22-20	22-22*	22-23	22-24	22-27
Number of Contacts/Size	14-#16	9-#16	4-#8	8-#12	2-#12, 4-#16	1-#8, 8-#16

* Indicates standard connector

Threaded Style Insert Arrangements

FRONT FACE OF PIN INSERTS ILLUSTRATED

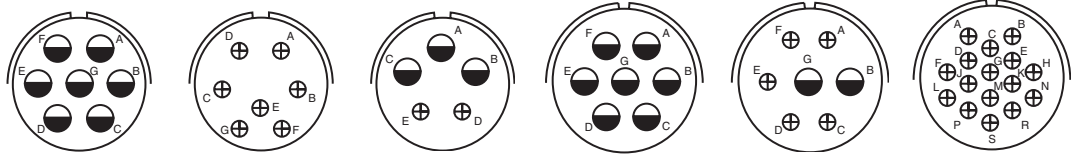

Shell Size/Layout	22-28	22-33	22-34	24-2	24-3	24-5
Number of Contacts/Size	7-#12	7-#16	3-#12, 2-#16	7-#12	2-#12, 5-#16	16-#16

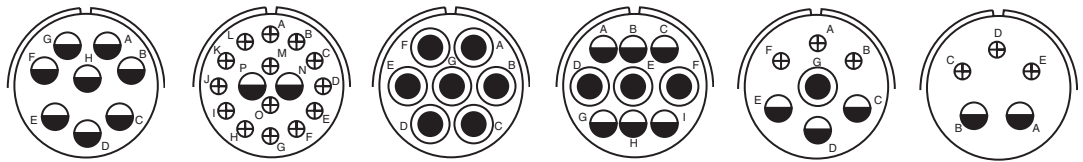

Shell Size/Layout	24-6	24-7*	24-10	24-11	24-16	24-17
Number of Contacts/Size	8-#12	2-#12, 14-#16	7-#8	3-#8, 6-#12	1-#8, 3-#12, 3-#16	2-#12, 3-#16

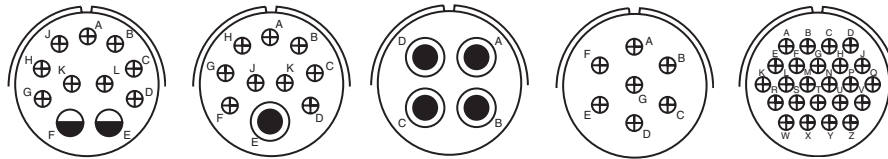

Shell Size/Layout	24-20	24-21	24-22*	24-27	24-28*
Number of Contacts/Size	2-#12, 9-#16	1-#8, 9-#16	4-#8	7-#16	24-#16

* Indicates standard connector

Threaded Style Dimensions

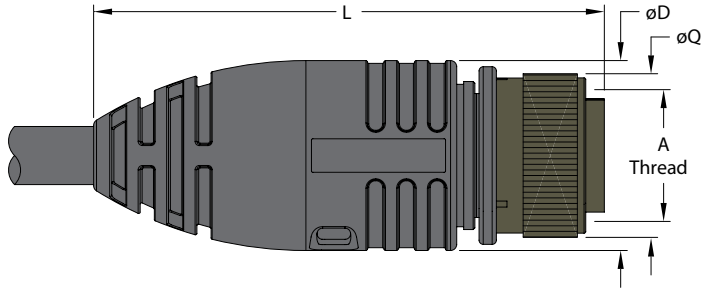

SHELL SIZE	A THREAD CLASS 2B	Q	D REF.	L REF.
8S	.5000-28UNEF	0.741 (18.8)	0.898 (22.8)	2.980 (75.7)
10S	.6250-24UNEF	0.869 (22.1)	0.898 (22.8)	2.980 (75.7)
10SL	.6250-24UNEF	0.946 (24.0)	0.898 (22.8)	2.980 (75.7)
12	.7500-20UNEF	0.955 (24.3)	1.122 (28.5)	3.181 (80.8)
12S	.7500-20UNEF	0.995 (25.3)	1.122 (28.5)	3.181 (80.8)
14	.8750-20UNEF	1.123 (28.5)	1.122 (28.5)	3.181 (80.8)
14S	.8750-20UNEF	1.123 (28.5)	1.122 (28.5)	3.181 (80.8)
16	1.0000-20UNEF	1.250 (31.8)	1.339 (34.0)	3.598 (91.4)
16S	1.0000-20UNEF	1.250 (31.8)	1.339 (34.0)	3.382 (85.9)
18	1.1250-18NEF	1.333 (33.9)	1.339 (34.0)	3.630 (92.2)
20	1.250-18NEF	1.461 (37.1)	1.594 (40.5)	4.256 (108.1)
22	1.3750-18NEF	1.588 (40.3)	1.594 (40.5)	4.295 (109.1)
24	1.5000-18NEF	1.715 (43.6)	1.791 (45.5)	4.319 (109.7)

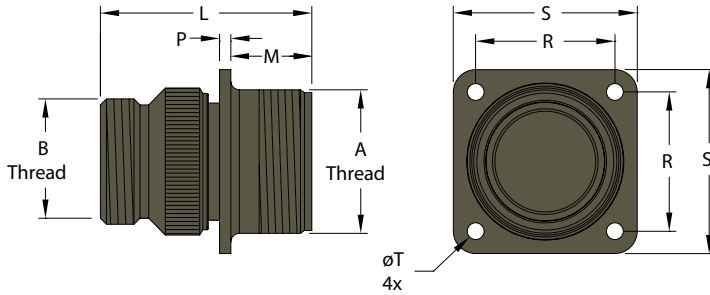

SHELL SIZE	A THREAD CLASS 2A	M $\pm .010$ $-.000$	P REF.	R $\pm .005$	S $\pm .031$	T DIA. $+.004$ $-.002$	L REF.	B THREAD CLASS 2A
8S	.5000-28UNEF	0.562 (14.3)	0.110 (2.8)	0.594 (15.1)	0.875 (22.2)	0.120 (3.0)	1.390 (35.3)	.5000-28UNEF
10S	.6250-24UNEF	0.562 (14.3)	0.110 (2.8)	0.719 (18.3)	1.000 (25.4)	0.120 (3.0)	1.468 (37.3)	.5000-28UNEF
10SL	.6250-24UNEF	0.562 (14.3)	0.110 (2.8)	0.719 (18.3)	1.000 (25.4)	0.120 (3.0)	1.468 (37.3)	.6250-24UNEF
12	.7500-20UNEF	0.750 (19.1)	0.110 (2.8)	0.812 (20.6)	1.094 (27.8)	0.120 (3.0)	1.843 (46.8)	.6250-24UNEF
12S	.7500-20UNEF	0.562 (14.3)	0.110 (2.8)	0.812 (20.6)	1.094 (27.8)	0.120 (3.0)	1.468 (37.3)	.6250-24UNEF
14	.8750-20UNEF	0.750 (19.1)	0.110 (2.8)	0.906 (23.0)	1.188 (30.2)	0.120 (3.0)	1.843 (46.8)	.7500-20UNEF
14S	.8750-20UNEF	0.562 (14.3)	0.110 (2.8)	0.906 (23.0)	1.188 (30.2)	0.120 (3.0)	1.468 (37.3)	.7500-20UNEF
16	1.0000-20UNEF	0.750 (19.1)	0.110 (2.8)	0.969 (24.6)	1.281 (32.5)	0.120 (3.0)	1.843 (46.8)	.8750-20UNEF
16S	1.0000-20UNEF	0.562 (14.3)	0.110 (2.8)	0.969 (24.6)	1.281 (32.5)	0.120 (3.0)	1.468 (37.3)	.8750-20UNEF
18	1.1250-18NEF	0.750 (19.1)	0.141 (3.6)	1.062 (27.0)	1.375 (34.9)	0.120 (3.0)	1.938 (49.2)	1.0000-20UNEF
20	1.1250-18NEF	0.750 (19.1)	0.141 (3.6)	1.156 (29.4)	1.500 (38.1)	0.120 (3.0)	1.844 (46.8)	1.875-18UNEF
22	1.3750-18NEF	0.750 (19.1)	0.141 (3.6)	1.25 (31.8)	1.625 (41.3)	0.120 (3.0)	1.938 (49.2)	1.875-18UNEF
24	1.5000-18NEF	0.812 (20.6)	0.141 (3.6)	1.375 (34.9)	1.750 (44.5)	0.147 (3.7)	1.969 (50.0)	1.4375-18UNEF

All dimensions in inches (millimeters in parenthesis)

We reserve the right to make technical alterations without prior notice.

Threaded Style Closure Caps

SHELL SIZE	PLUG CAP			RECEPTACLE CAP	
	CABLE LOOP LANYARD	CHAIN LANYARD	EYELET LANYARD	CABLE LOOP LANYARD	CHAIN LANYARD
8S	MS 3106-8S-CC	MS 3106-8S-CL	MS 3100-8S-CC	MS 3101-8S-CC	MS 3100-8S-CL
10S/10SL	MS 3106-10-CC	MS 3106-10-CL	MS 3100-10-CC	MS 3101-10-CC	MS 3100-10-CL
12/12S	MS 3106-12-CC	MS 3106-12-CL	MS 3100-12-CC	MS 3101-12-CC	MS 3100-12-CL
14/14S	MS 3106-14-CC	MS 3106-14-CL	MS 3100-14-CC	MS 3101-14-CC	MS 3100-14-CL
16	MS 3106-16-CC	MS 3106-16-CL	MS 3100-16-CC	MS 3101-16-CC	MS 3100-16-CL
16S	MS 3106-16S-CC	MS 3106-16S-CL	MS 3100-16S-CC	MS 3101-16S-CC	MS 3100-16S-CL
18	MS 3106-18-CC	MS 3106-18-CL	MS 3100-18-CC	MS 3101-18-CC	MS 3100-18-CL
20	MS 3106-20-CC	MS 3106-20-CL	MS 3100-20-CC	MS 3101-20-CC	MS 3100-20-CL
22	MS 3106-22-CC	MS 3106-22-CL	MS 3100-22-CC	MS 3101-22-CC	MS 3100-22-CL
24	MS 3106-24-CC	MS 3106-24-CL	MS 3100-24-CC	MS 3101-24-CC	MS 3100-24-CL

Plug Cap - Cable Loop Lanyard

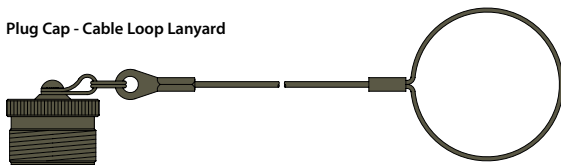

Receptacle Cap - Eyelet Lanyard



Plug Cap - Chain Lanyard

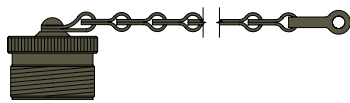

Receptacle Cap - Cable Loop Lanyard

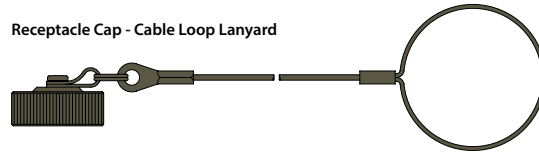

Receptacle Cap - Chain Lanyard



We reserve the right to make technical alterations without prior notice.

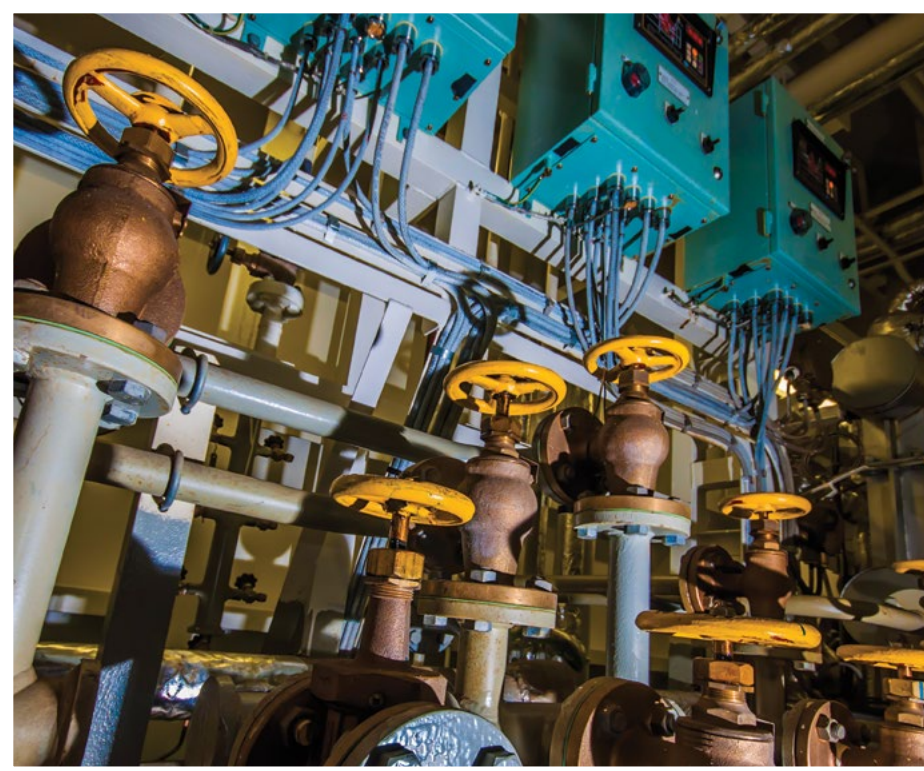

Bayonet

Turck's overmolded MIL-DTL- 26482 Series I bayonet style connectors provide a quick-connect and disconnect solution that is well-equipped to handle applications with vibration and a high number of circuits. Overmolded Mil-Spec connectors provide a reduction in labor over traditional field-assembled connectors and diminish the risk of mis-wiring by providing a fully overmolded cordset assembly, allowing you to decrease downtime and save money. Turck's overmold design technology provides the flexibility to seal the connectors to a wide variety of different cable types. An industry standard for connecting to instrumentation on mobile equipment, including off-road vehicles, heavy-duty construction vehicles and data vans, the bayonet style connector is an ideal solution for harsh applications, applications where mating and unmating are frequent, and where higher pin counts are needed for a high number of circuits or signals.

Applications:

- Off-road vehicles
- Heavy duty construction vehicles
- Ships
- Engines
- Power Generators
- Telecommunication applications
- Industrial machinery
- Instrumentation applications such as temperature, pressure, and flow monitoring



Bayonet Technical Specifications

Mechanical

Mold material/Color:	PVC/Black
Contact carrier material:	Neoprene
Coupling nut material/Plating:	Aluminum alloy/Olive drab chromate
Mold sleeve material/Plating:	Aluminum/Black anodized
Environmental protection:	NEMA 1, 3, 4, 6P IEC IP67, IP68
Temperature rating:	From -60 °C to 105 °C (-76 °F to 221 °F)
Contact sizes:	Contact size 20 accommodates wire sizes 20-24 AWG Contact size 16 accommodates wire sizes 16-18 AWG Contact size 12 accommodates wire sizes 12-14 AWG

Electrical

Contact material/Plating:	Copper alloy/Gold
Current:	Up to 23 amps
Voltage:	Up to 600 volts
Wire range sizes:	12 to 24 AWG
Number of circuits:	2 to 32

We reserve the right to make technical alterations without prior notice.

Bayonet Overmolded Cordset Part Number Guide

Bayonet MIL-DTL-26482

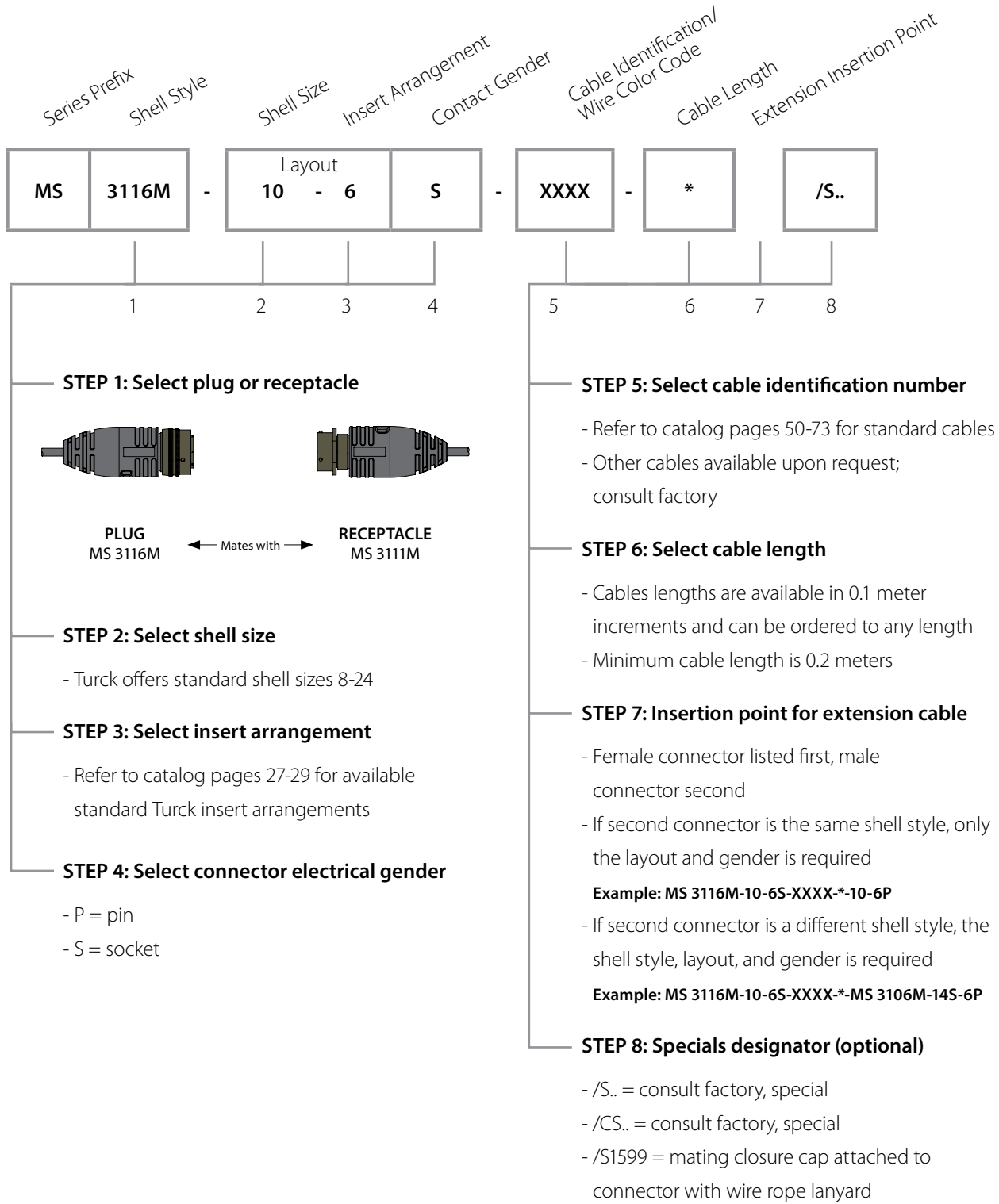

Part Number Keys are to assist in identification only. Not all configurations may be available. Consult factory for product availability.

Bayonet Receptacle Part Number Guide

Bayonet MIL-DTL-26482

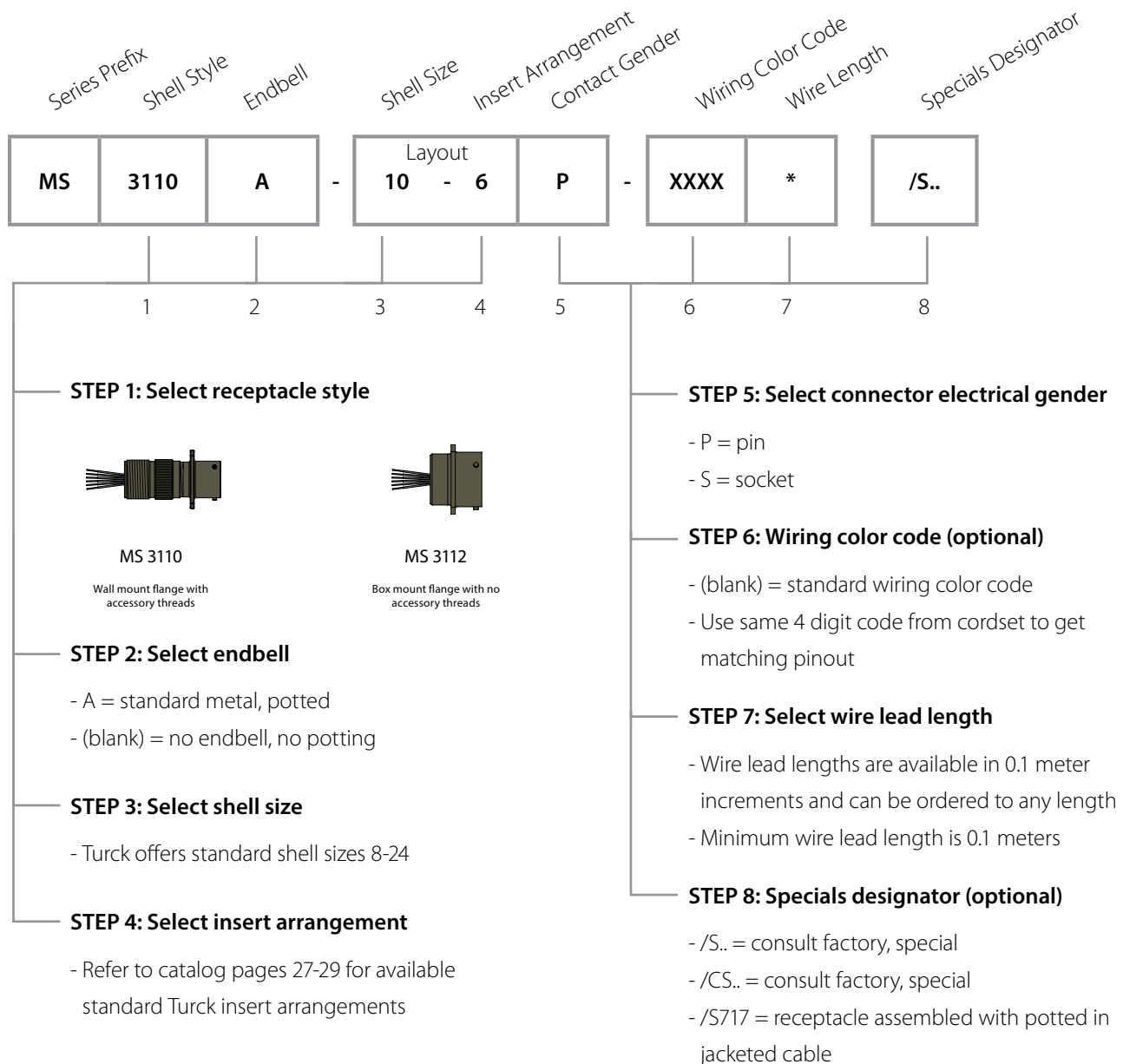

Part Number Keys are to assist in identification only. Not all configurations may be available. Consult factory for product availability.







Bayonet Style Insert Arrangements





LAYOUT	TOTAL CONTACTS	CONTACT SIZES (AWG)			PAGE NUMBER
		12-14	16-18	20-24	
8-2	2			2	28
8-3	3			3	28
8-33	3			3	28
8-98	3			3	28
12-3	3		3		28
14-91	3			3	28
8-4	4			4	28
12-4	4		4		28
14-4	4	4			28
10-5	5			5	28
14-5	5		5		28
14-22	5	4		1	28
18-5	5	5			28
10-6	6			6	28
10-98	6			6	28
18-91	6			6	29
20-90	7			7	29
22-96	7	7			29
12-8	8			8	28
16-8	8		8		28
18-8	8	8			28
12-10	10			10	28
18-11	11		11		28
14-12	12		4	8	28
12-14	14			14	28
14-15	15		1	14	28
20-16	16		16		29
14-18	18			18	28
14-19	19			19	28
22-21	21		21		29
16-23	23		1	22	28
16-99	23		2	21	28
20-24	24			24	29
20-25	25			25	29
22-25	25		25		29
16-26	26			26	28
20-27	27			27	29
18-30	30		1	29	28
24-31	31		31		29
18-32	32			32	29
22-32	32			32	29
22-34	34			34	29



We reserve the right to make technical alterations without prior notice.

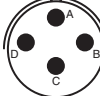

Bayonet Style Insert Arrangements

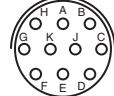
FRONT FACE OF PIN INSERTS ILLUSTRATED

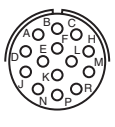
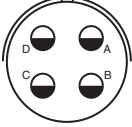
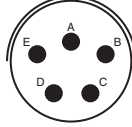
						
Shell Size/Layout	8-2	8-3	8-4	8-33	8-98	10-5
Number of Contacts/Size	2-#20	3-#20	4-#20	3-#20	3-#20	5-#20

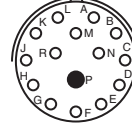
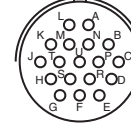
						
Shell Size/Layout	10-6	10-98	12-3	12-4	12-8	12-10
Number of Contacts/Size	6-#20	6-#20	3-#16	4-#16	8-#20	10-#20

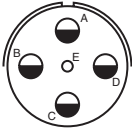
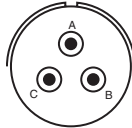
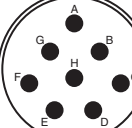
						
Shell Size/Layout	12-14	14-4	14-5	14-12	14-15	14-18
Number of Contacts/Size	14-#20	4-#12	5-#16	8-#20, 4-#16	14-#20, 1-#16	18-#20

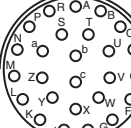
						
Shell Size/Layout	14-19	14-22	14-91 HV	16-8	16-23	16-26
Number of Contacts/Size	19-#20	1-#20, 4-#12	3-#20	8-#16	22-#20, 1-#16	26-#20

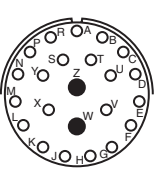
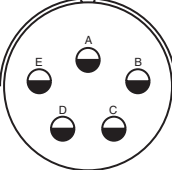
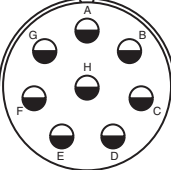
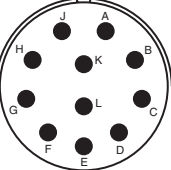
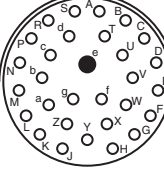
					
Shell Size/Layout	16-99	18-5	18-8	18-11	18-30
Number of Contacts/Size	21-#20, 2-#16	5-#12	8-#12	11-#16	29-#20, 1-#16

Bayonet Style Insert Arrangements

FRONT FACE OF PIN INSERTS ILLUSTRATED

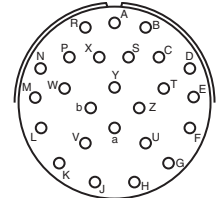
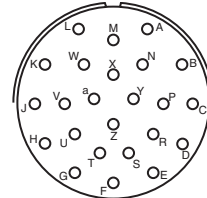
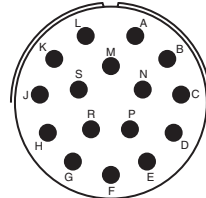
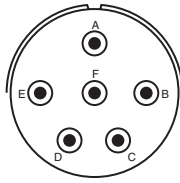
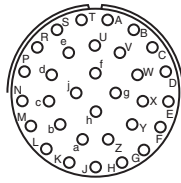

Shell Size/Layout	18-32	18-91 HV	20-16	20-24	20-25
Number of Contacts/Size	32-#20	6-#20	16-#16	24-#20	25-#20

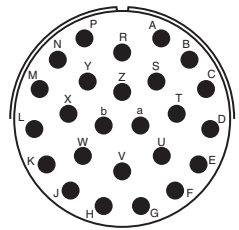
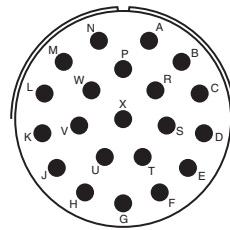
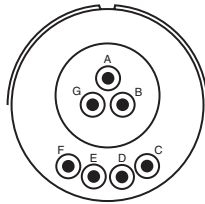
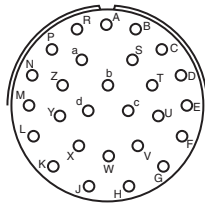

Shell Size/Layout	20-27	20-90	22-21	22-25
Number of Contacts/Size	27-#20	7-#20	21-#16	25-#16

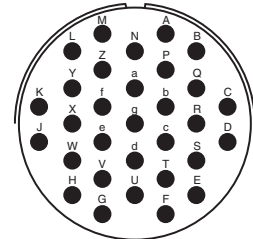
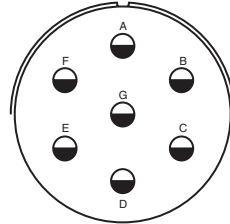
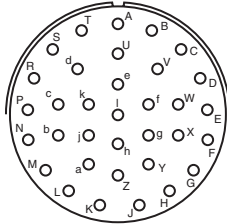
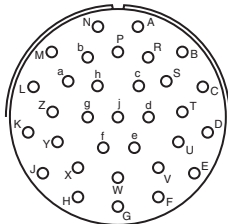

Shell Size/Layout	22-32	22-34	22-96	24-31
Number of Contacts/Size	32-#20	34-#20	7-#12	31-#16

Bayonet Style Dimensions

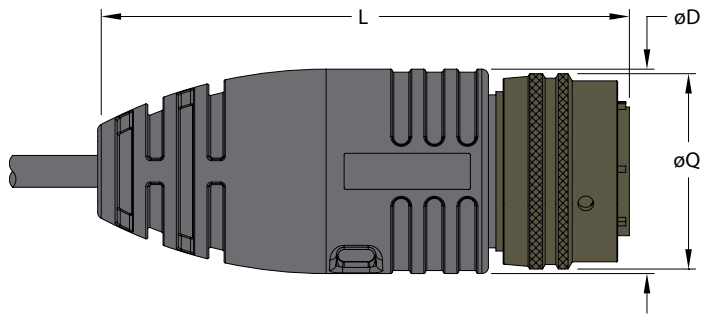

SHELL SIZE	Q	D REF.	L REF.
8	0.750 (19.1)	0.898 (22.8)	3.087 (78.4)
10	0.859 (21.8)	0.898 (22.8)	3.087 (78.4)
12	1.013 (25.7)	1.122 (28.5)	3.287 (83.5)
14	1.156 (29.4)	1.122 (28.5)	3.287 (83.5)
16	1.281 (32.5)	1.339 (34.0)	3.484 (88.5)
18	1.319 (33.5)	1.339 (34.0)	3.484 (88.5)
20	1.531 (38.9)	1.594 (40.5)	4.295 (109.1)
22	1.656 (42.1)	1.594 (40.5)	4.303 (109.3)
24	1.776 (45.1)	1.791 (45.5)	4.358 (110.7)

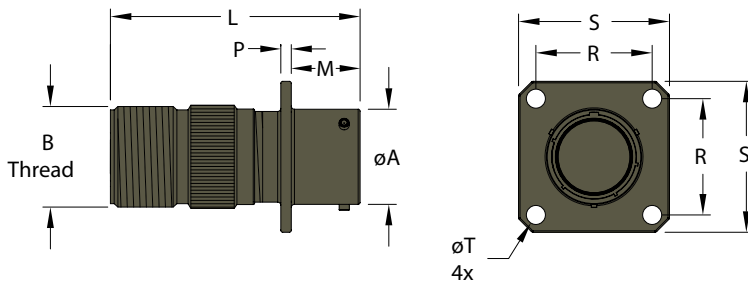

SHELL SIZE	M	A +.001-.055	P REF.	R REF.	S REF.	T DIA REF.	L REF.	B THREAD
8	0.431 (10.9)	0.473 (12.0)	0.062 (1.6)	0.594 (15.1)	0.812 (20.6)	0.120 (3.0)	1.553 (39.4)	.5000-28 UNEF
10	0.431 (10.9)	0.590 (15.0)	0.062 (1.6)	0.719 (18.3)	0.938 (23.8)	0.120 (3.0)	1.553 (39.4)	.6250-24 UNEF
12	0.431 (10.9)	0.750 (19.1)	0.062 (1.6)	0.812 (20.6)	1.031 (26.2)	0.120 (3.0)	1.553 (39.4)	.7500-20 UNEF
14	0.431 (10.9)	0.875 (22.2)	0.062 (1.6)	0.906 (23.0)	1.125 (28.6)	0.120 (3.0)	1.553 (39.4)	.8750-20 UNEF
16	0.431 (10.9)	1.000 (25.4)	0.062 (1.6)	0.969 (24.6)	1.219 (31.0)	0.120 (3.0)	1.553 (39.4)	1.0000-20 UNEF
18	0.431 (10.9)	1.125 (28.6)	0.062 (1.6)	1.062 (27.0)	1.312 (33.3)	0.120 (3.0)	1.553 (39.4)	1.1875-18 UNEF
20	0.556 (14.1)	1.250 (31.8)	0.094 (2.4)	1.156 (29.4)	1.438 (36.5)	0.120 (3.0)	1.703 (43.3)	1.1875-18 UNEF
22	0.556 (14.1)	1.375 (34.9)	0.094 (2.4)	1.250 (31.8)	1.561 (39.6)	0.120 (3.0)	1.703 (43.3)	1.4375-18 UNEF
24	0.556 (14.1)	1.500 (38.1)	0.127 (3.2)	1.375 (34.9)	1.688 (42.9)	0.147 (3.7)	1.765 (44.8)	1.4375-18 UNEF

All dimensions in inches (millimeters in parenthesis)

We reserve the right to make technical alterations without prior notice.

Bayonet Style Closure Caps

SHELL SIZE	PLUG CAP			RECEPTACLE CAP	
	CABLE LOOP LANYARD	CHAIN LANYARD	EYELET LANYARD	CABLE LOOP LANYARD	CHAIN LANYARD
8	MS 3116-8-CC	MS 3116-8-CL	MS 3110-8-CC	MS 3111-8-CC	MS 3110-8-CL
10	MS 3116-10-CC	MS 3116-10-CL	MS 3110-10-CC	MS 3111-10-CC	MS 3110-10-CL
12	MS 3116-12-CC	MS 3116-12-CL	MS 3110-12-CC	MS 3111-12-CC	MS 3110-12-CL
14	MS 3116-14-CC	MS 3116-14-CL	MS 3110-14-CC	MS 3111-14-CC	MS 3110-14-CL
16	MS 3116-16-CC	MS 3116-16-CL	MS 3110-16-CC	MS 3111-16-CC	MS 3110-16-CL
18	MS 3116-18-CC	MS 3116-18-CL	MS 3110-18-CC	MS 3111-18-CC	MS 3110-18-CL
20	MS 3116-20-CC	MS 3116-20-CL	MS 3110-20-CC	MS 3111-20-CC	MS 3110-20-CL
22	MS 3116-22-CC	MS 3116-22-CL	MS 3110-22-CC	MS 3111-22-CC	MS 3110-22-CL
24	MS 3116-24-CC	MS 3116-24-CL	MS 3110-24-CC	MS 3111-24-CC	MS 3110-24-CL

Plug Cap - Cable Loop Lanyard

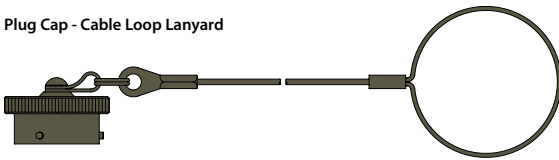

Receptacle Cap - Eyelet Lanyard



Plug Cap - Chain Lanyard



Receptacle Cap - Cable Loop Lanyard



Receptacle Cap - Chain Lanyard



We reserve the right to make technical alterations without prior notice.



Reverse Bayonet

Turck's overmolded GT Series reverse bayonet style connectors replace the threaded coupling in MIL-DTL-5015 connectors with a quick-mating, reverse bayonet lock for improved performance. Overmolded Mil-Spec connectors provide a reduction in labor over traditional field-assembled connectors and diminish the risk of mis-wiring by providing a fully overmolded cordset assembly, allowing you to decrease downtime and save money. Turck's overmold design technology provides the flexibility to seal the connectors to a wide variety of different cable types. An industry standard for mobile equipment applications—including rail, mass transit and ground vehicles—the reverse bayonet style connector is an ideal option for harsh applications. The reverse bayonet style uses the same shell dimensions, contact layouts, contacts and performance characteristics as the MIL-DTL-5015 threaded connectors; however, the two series do not intermate. The connectors are sealed to withstand moisture, condensation and vibration. Variations in contact layouts allow for just power, just signal or a mix of both contact types.

Applications:

- Ships
- Railway equipment
- Mass transit
- Off-road construction equipment
- Telecommunications
- Industrial machinery
- Power generators
- Applications involving sensors or motion control

Variety of cable options available

Quick connect/disconnect

Meets NEMA 1, 3, 4, 6P
and IEC IP67, IP68 rated

Eyelet for closure
cap lanyard

"Clicks" into place

Provides more options for
power applications

Shell sizes 8-24



Reverse Bayonet Technical Specifications

Mechanical

Mold material/Color:	PVC/Black
Contact carrier material:	Neoprene
Coupling nut material/Plating:	Aluminum alloy/Olive drab chromate
Mold sleeve material/Plating:	Aluminum/Black anodized
Environmental protection:	NEMA 1, 3, 4, 6P IEC IP67, IP68
Temperature rating:	From -60 °C to 105 °C (-76 °F to 221 °F)
Contact sizes:	Contact size 16 accommodates wire sizes 16-24 AWG Contact size 12 accommodates wire sizes 12-14 AWG Contact size 8 accommodates wire sizes 8-10 AWG

Electrical

Contact material/Plating:	Copper alloy/Silver
Current:	Up to 44 amps
Voltage:	Up to 600 volts
Wire range sizes:	8 to 24 AWG
Number of circuits:	1 to 28

We reserve the right to make technical alterations without prior notice.

Reverse Bayonet Overmolded Cordset Part Number Guide

Reverse Bayonet GT Series

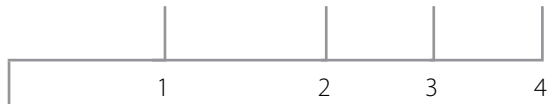
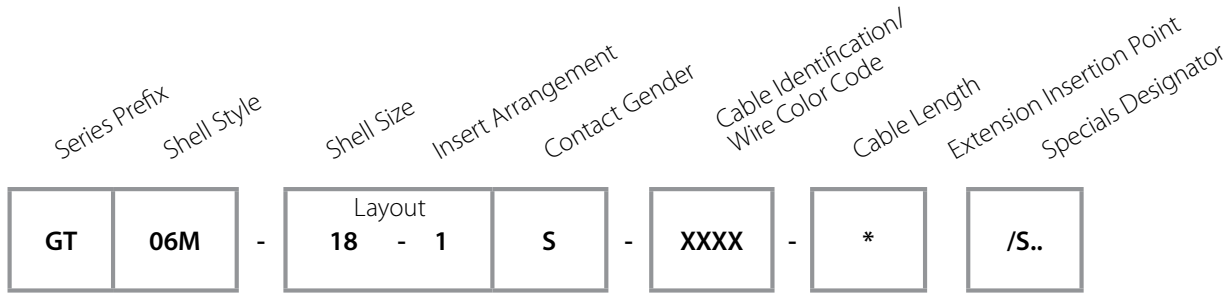

STEP 1: Select plug or receptacle

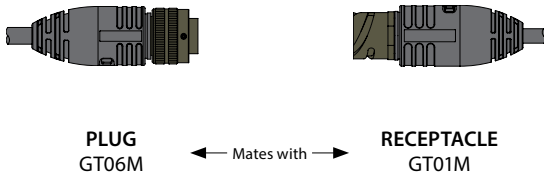

STEP 2: Select shell size

- Turck offers standard shell sizes 8-24

STEP 3: Select insert arrangement

- Refer to catalog pages 37-45 for available standard Turck insert arrangements

STEP 4: Select connector electrical gender

- P = pin
- S = socket



STEP 5: Select cable identification number

- Refer to catalog pages 50-73 for standard cables
- Other cables available upon request; consult factory

STEP 6: Select cable length

- Cables lengths are available in 0.1 meter increments and can be ordered to any length
- Minimum cable length is 0.2 meters

STEP 7: Insertion point for extension cable

- Female connector listed first, male connector second
- If second connector is the same shell style, only the layout and gender is required

Example: GT06M-18-1S-XXXX-18-1P

- If second connector is a different shell style, the shell style, layout, and gender is required

Example: GT06M-18-1S-XXXX-MS 3106M-18-1P

STEP 8: Specials designator (optional)

- /S.. = consult factory, special
- /CS.. = consult factory, special
- /S1599 = mating closure cap attached to connector with wire rope lanyard

Part Number Keys are to assist in identification only. Not all configurations may be available. Consult factory for product availability.

Reverse Bayonet Receptacle Part Number Guide

Reverse Bayonet GT Series

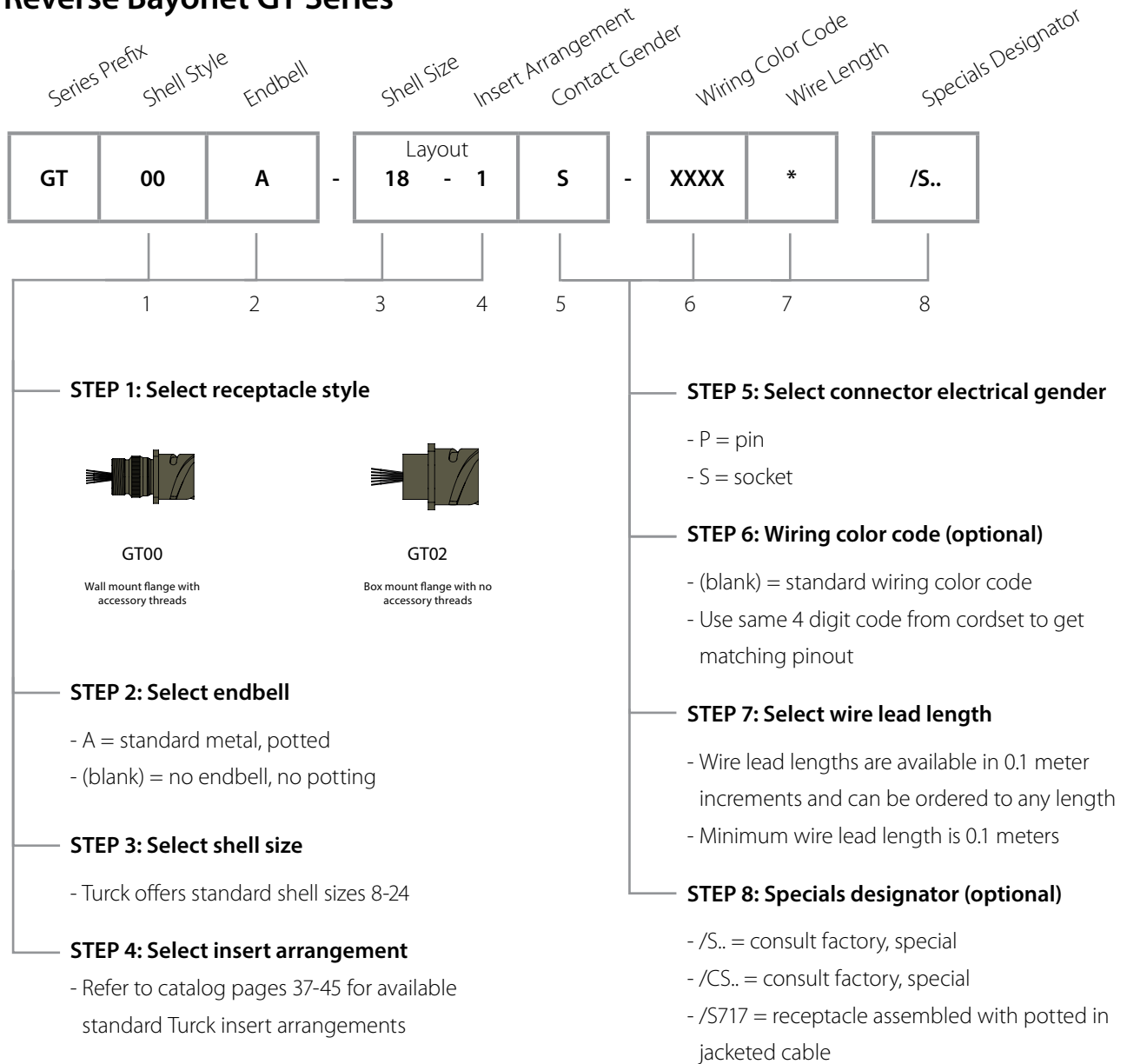

Reverse Bayonet Style Insert Arrangements

LAYOUT	TOTAL CONTACTS	CONTACT SIZES (AWG)			PAGE NUMBER
		8-10	12-14	16-20	
14S-4	1			1	41
16S-3	1			1	41
16-2	1		1		41
18-7	1	1			41
18-16	1		1		42
24-52	1		1		44
10SL-4†*	2			2	41
14S-9*	2			2	41
16S-4	2			2	41
16-11	2		2		41
18-3	2		2		41
20-23	2	2			42
22-1	2	2			43
22-8	2		2		43
22-11	2			2	43
10SL-3	3			3	41
14S-7	3			3	41
14S-12	3			3	41
16S-5	3			3	41
16S-6	3			3	41
16-7	3	1		2	41
16-10	3		3		41
18-22	3			3	42
20-3	3		3		42
20-6	3			3	42
20-19	3	3			42
20-51	3	3			43
20-59	3	3			43
22-2	3	3			43
22-6	3	2		1	43
22-9	3		3		43
22-80	3	3			44
14S-2*	4			4	41
14S-10	4			4	41
16-9	4		2	2	41
16-59	4		4		41
18-4*	4			4	41
18-10*	4		4		41
18-13	4	1	3		42

† 10SL-4 arrangement available only with pin contacts in receptacle and socket contacts in plug

* Indicates standard connector

Reverse Bayonet Style Insert Arrangements

LAYOUT	TOTAL CONTACTS	CONTACT SIZES (AWG)			PAGE NUMBER
		8-10	12-14	16-20	
20-4*	4		4		42
20-24	4	2		2	42
22-4	4	2	2		43
22-10	4			4	43
22-22*	4	4			43
24-22*	4	4			44
14S-5*	5			5	41
16S-8*	5			5	41
18-11*	5		5		41
18-20	5			5	42
18-29	5			5	42
18-30	5			5	42
18-31	5			5	42
20-14	5	2	3		42
22-12	5	2		3	43
22-13	5		4	1	43
22-34	5		3	2	44
24-17	5		2	3	44
24-53	5	5			44
24-79	5	5			45
14S-6*	6			6	41
18-12	6			6	42
20-8	6	2		4	42
20-17	6		5	1	42
20-22	6	3		3	42
20-66	6		5	1	43
22-5	6		2	4	43
22-15	6		5	1	43
22-24	6		2	4	44
14S-A7	7			7	41
16S-1*	7			7	41
18-9	7		2	5	41
18-17	7		2	5	42
20-15*	7		7		42
20-57	7		7		43
22-28	7		7		44
22-33	7			7	44
24-2	7		7		44
24-3	7		2	5	44

* Indicates standard connector

We reserve the right to make technical alterations without prior notice.

Reverse Bayonet Style Insert Arrangements

LAYOUT	TOTAL CONTACTS	CONTACT SIZES (AWG)			PAGE NUMBER
		8-10	12-14	16-20	
24-10	7	7			44
24-16	7	1	3	3	44
24-27	7			7	44
24-60	7	7			44
24-66	7		7		45
24-71	7	7			45
24-75	7	7			45
18-8*	8		1	7	41
20-7*	8			8	42
20-9	8		1	7	42
20-79	8		1	7	43
22-18	8			8	43
22-23	8		8		43
22-65	8		8		44
24-6	8		8		44
20-16	9		2	7	42
20-18*	9		3	6	42
20-21	9		1	8	42
22-16	9		3	6	43
22-17	9		1	8	43
22-20	9			9	43
22-27	9	1		8	44
24-11	9	3	6		44
18-1*	10			10	41
18-19	10			10	42
18-24	10			10	42
20-58	10		5	5	43
24-21	10	1		9	44
20-33	11			11	43
24-20	11		2	9	44
22-63	12		4	8	44
24-19	12			12	44
20-11	13			13	42
20-25	13			13	42
20-30	13			13	43
22-70	13		8	5	44
24-58	13	3	3	7	44
20-27*	14			14	43
22-19*	14			14	43
24-59	14		7	7	44

* Indicates standard connector

We reserve the right to make technical alterations without prior notice.

Reverse Bayonet Style Insert Arrangements

LAYOUT	TOTAL CONTACTS	CONTACT SIZES (AWG)			PAGE NUMBER
		8-10	12-14	16-20	
24-65	15		11	4	44
24-5	16			16	44
24-7*	16		2	14	44
20-29*	17			17	43
20-26	19			19	42
22-14*	19			19	43
24-67	19		19		45
24-80	23			23	45
24-28*	24			24	44
24-AJ	25			25	45
24-96	28			28	45

* Indicates standard connector

Reverse Bayonet Style Insert Arrangements

FRONT FACE OF PIN INSERTS ILLUSTRATED

Shell Size/Layout	10SL-3	10SL-4*	14S-2*	14S-4	14S-5*	14S-6*	14S-7
Number of Contacts/Size	3-#16	2-#16	4-#16	1-#16	5-#16	6-#16	3-#16

Shell Size/Layout	14S-9*	14S-10	14S-12	14S-A7	16S-1*	16S-3	16S-4
Number of Contacts/Size	2-#16	4-#16	3-#16	7-#16	7-#16	1-#16	2-#16

Shell Size/Layout	16S-5	16S-6	16S-8*	16-2	16-7	16-9
Number of Contacts/Size	3-#16	3-#16	5-#16	1-#12	1-#8, 2-#16	2-#12, 2-#16

Shell Size/Layout	16-10	16-11	16-59	18-1*	18-3	18-4*
Number of Contacts/Size	3-#12	2-#12	4-#12	10-#16	2-#12	4-#16

Shell Size/Layout	18-5	18-7	18-8*	18-9	18-10*	18-11*
Number of Contacts/Size	2-#12, 1-#16	1-#8	1-#12, 7-#16	2-#12, 5-#16	4-#12	5-#12

* Indicates standard connector

Reverse Bayonet Style Insert Arrangements

FRONT FACE OF PIN INSERTS ILLUSTRATED

Shell Size/Layout	18-12	18-13	18-16	18-17	18-19	18-20
Number of Contacts/Size	6-#16	1-#8, 3-#12	1-#12	2-#12, 5-#16	10-#16	5-#16

Shell Size/Layout	18-22	18-24	18-29	18-30	18-31	20-3
Number of Contacts/Size	3-#16	10-#16	5-#16	5-#16	5-#16	3-#12

Shell Size/Layout	20-4*	20-6	20-7*	20-8	20-9	20-11
Number of Contacts/Size	4-#12	3-#16	8-#16	2-#8, 4-#16	1-#12, 7-#16	13-#16

Shell Size/Layout	20-14	20-15*	20-16	20-17	20-18*	20-19
Number of Contacts/Size	2-#8, 3-#12	7-#12	2-#12, 7-#16	5-#12, 1-#16	3-#12, 6-#16	3-#8

Shell Size/Layout	20-21	20-22	20-23	20-24	20-25	20-26
Number of Contacts/Size	1-#12, 8-#16	3-#8, 3-#16	2-#8	2-#8, 2-#16	13-#16	19-#16

* Indicates standard connector

Reverse Bayonet Style Insert Arrangements

FRONT FACE OF PIN INSERTS ILLUSTRATED

Shell Size/Layout	20-27*	20-29*	20-30	20-33	20-51	20-57
Number of Contacts/Size	14-#16	17-#16	13-#16	11-#16	3-#8	7-#12

Shell Size/Layout	20-58	20-59	20-66	20-79	22-1	22-2
Number of Contacts/Size	5-#12, 5-#16	3-#8	1-#16, 5-#12	7-#16, 1-#12	2-#8	3-#8

Shell Size/Layout	22-4	22-5	22-6	22-8	22-9	22-10
Number of Contacts/Size	2-#8, 2-#12	2-#12, 4-#16	2-#8, 1-#16	2-#12	3-#12	4-#16

Shell Size/Layout	22-11	22-12	22-13	22-14*	22-15	22-16
Number of Contacts/Size	2-#16	2-#8, 3-#16	4-#12, 1-#16	19-#16	5-#12, 1-#16	3-#12, 6-#16

Shell Size/Layout	22-17	22-18	22-19*	22-20	22-22*	22-23
Number of Contacts/Size	1-#12, 8-#16	8-#16	14-#16	9-#16	4-#8	8-#12

* Indicates standard connector

Reverse Bayonet Style Insert Arrangements

FRONT FACE OF PIN INSERTS ILLUSTRATED

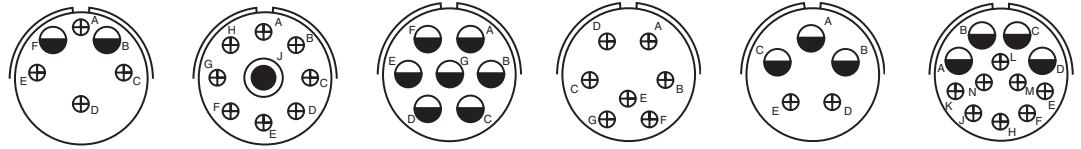

Shell Size/Layout	22-24	22-27	22-28	22-33	22-34	22-63
Number of Contacts/Size	2-#12, 4-#16	1-#8, 8-#16	7-#12	7-#16	3-#12, 2-#16	4-#12, 8-#16

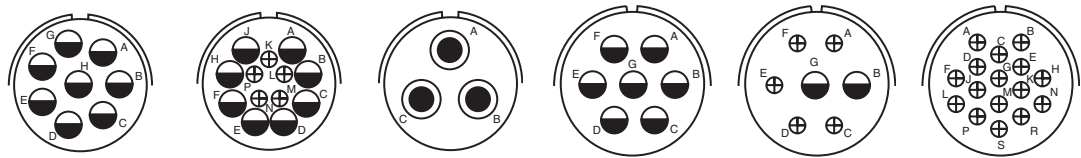

Shell Size/Layout	22-65	22-70	22-80	24-2	24-3	24-5
Number of Contacts/Size	8-#12	8-#12, 5-#16	3-#8	7-#12	2-#12, 5-#16	16-#16

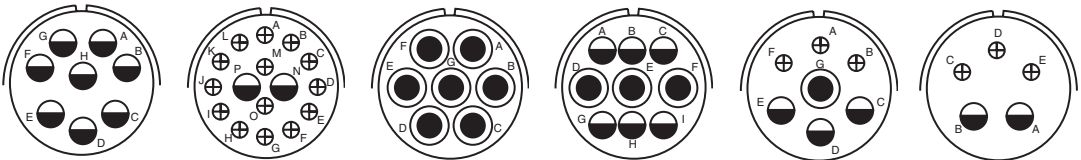

Shell Size/Layout	24-6	24-7*	24-10	24-11	24-16	24-17
Number of Contacts/Size	8-#12	2-12, 14-16	7-#8	3-#8, 6-#12	1-#8, 3-#12, 3-#16	2-#12, 3-#16

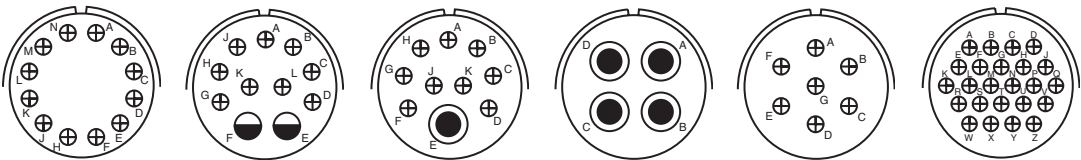

Shell Size/Layout	24-19	24-20	24-21	24-22	24-27	24-28*
Number of Contacts/Size	12-#16	2-#12, 9-#16	1-#8, 9-#16	4-#8	7-#16	24-#16

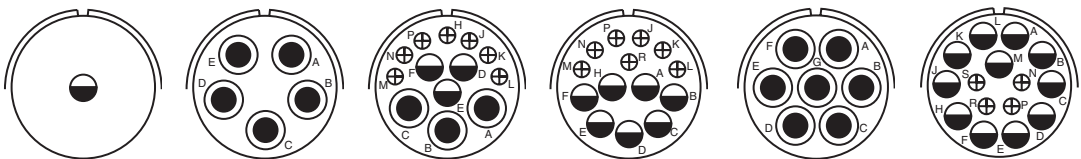

Shell Size/Layout	24-52	24-53	24-58	24-59	24-60	24-65
Number of Contacts/Size	1-#12	5-#8	3-#8, 3-#12, 7-#16	7-#12, 7-#16	7-#8	11-#12, 4-#16

* Indicates standard connector

Reverse Bayonet Style Insert Arrangements

FRONT FACE OF PIN INSERTS ILLUSTRATED

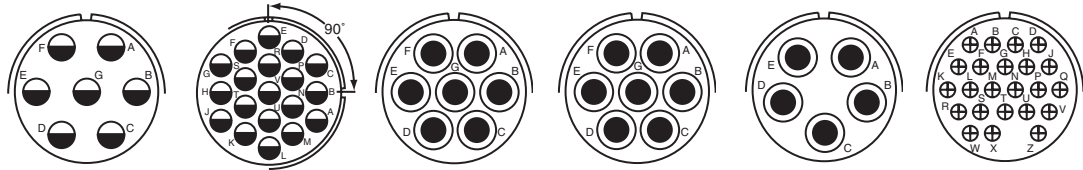

Shell Size/Layout	24-66	24-67	24-71	24-75	24-79	24-80
Number of Contacts/Size	7-#12	19-#12	7-#8	7-#8	5-#8	23-#16

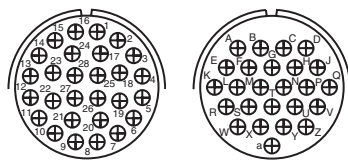

Shell Size/Layout	24-96	24-AJ
Number of Contacts/Size	28-#16	25-#16

* Indicates standard connector

Reverse Bayonet Style Dimensions

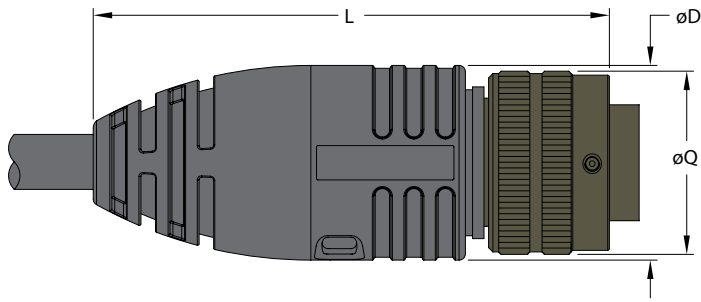

SHELL SIZE	Q	D REF.	L REF.
10SL	.898 (22.8)	0.898 (22.8)	3.087 (78.4)
14S	1.150 (29.2)	1.122 (28.5)	3.299 (83.8)
16	1.260 (32.0)	1.339 (34.0)	3.756 (95.4)
16S	1.260 (32.0)	1.339 (34.0)	3.500 (88.9)
18	1.437 (36.5)	1.339 (34.0)	3.799 (96.5)
20	1.571 (39.9)	1.594 (40.5)	4.445 (112.9)
22	1.697 (43.1)	1.594 (40.5)	4.445 (112.9)
24	1.835 (46.6)	1.791 (45.5)	4.445 (112.9)

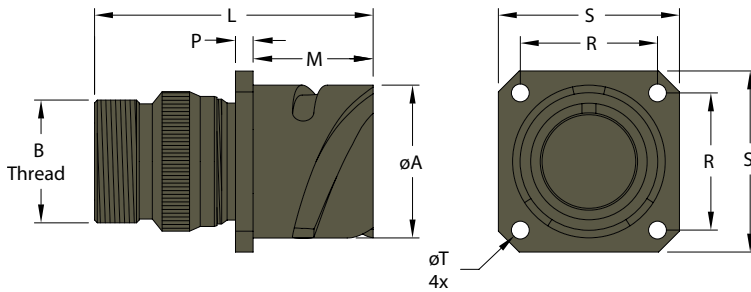

SHELL SIZE	M +.016-.000	A +.000-.006	P +/- .008	R +/- .004	S +/- .012	T +.004-.000	L + .012	B THREAD CLASS 2A
10SL	.717 (18.20)	.717 (18.2)	.110 (2.8)	.717 (18.2)	1.000 (25.4)	.126 (3.2)	1.969 (50)	.6250-24 UNEF
14S	.717 (18.20)	.969 (24.6)	.126 (3.2)	.906 (23.0)	1.181 (30.0)	.126 (3.2)	1.969 (50)	.7500-20 UNEF
16	.846 (21.50)	1.079 (27.4)	.126 (3.2)	.969 (24.6)	1.280 (32.5)	.126 (3.2)	2.362 (60)	.8750-20 UNEF
16S	.717 (18.20)	1.079 (27.4)	.126 (3.2)	.969 (24.6)	1.280 (32.5)	.126 (3.2)	1.969 (50)	.8750-20 UNEF
18	.907 (23.05)	1.213 (30.8)	.157 (4.0)	1.063 (27.0)	1.378 (35.0)	.126 (3.2)	2.362 (60)	1.0000-20 UNEF
20	.907 (23.05)	1.346 (34.2)	.157 (4.0)	1.157 (29.4)	1.496 (38.0)	.126 (3.2)	2.362 (60)	1.1875-18 UNEF
22	.907 (23.05)	1.472 (37.4)	.157 (4.0)	1.252 (31.8)	1.614 (41.0)	.126 (3.2)	2.362 (60)	1.1875-18 UNEF
24	.907 (23.05)	1.610 (40.9)	.157 (4.0)	1.374 (34.9)	1.752 (44.5)	.146 (3.7)	2.560 (65)	1.4375-18 UNEF

All dimensions in inches (millimeters in parenthesis)

We reserve the right to make technical alterations without prior notice.

Reverse Bayonet Style Closure Caps

SHELL SIZE	PLUG CAP			RECEPTACLE CAP	
	CABLE LOOP LANYARD	CHAIN LANYARD	EYELET LANYARD	CABLE LOOP LANYARD	CHAIN LANYARD
10SL	GT06-10SL-CC	GT06-10SL-CL	GT00-10SL-CC	GT01-10SL-CC	GT00-10SL-CL
14S	GT06-14S-CC	GT06-14S-CL	GT00-14S-CC	GT01-14S-CC	GT00-14S-CL
16	GT06-16-CC	GT06-16-CL	GT00-16-CC	GT01-16-CC	GT00-16-CL
16S	GT06-16S-CC	GT06-16S-CL	GT00-16S-CC	GT01-16S-CC	GT00-16S-CL
18	GT06-18-CC	GT06-18-CL	GT00-18-CC	GT01-18-CC	GT00-18-CL
20	GT06-20-CC	GT06-20-CL	GT00-20-CC	GT01-20-CC	GT00-20-CL
22	GT06-22-CC	GT06-22-CL	GT00-22-CC	GT01-22-CC	GT00-22-CL
24	GT06-24-CC	GT06-24-CL	GT00-24-CC	GT01-24-CC	GT00-24-CL

Plug Cap - Cable Loop Lanyard

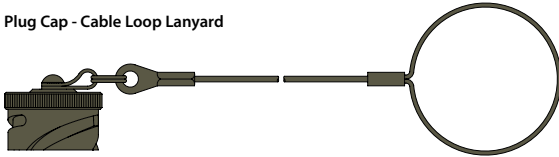

Receptacle Cap - Eyelet Lanyard



Plug Cap - Chain Lanyard

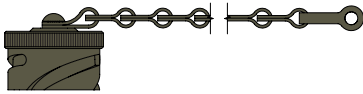

Receptacle Cap - Cable Loop Lanyard



Receptacle Cap - Chain Lanyard



We reserve the right to make technical alterations without prior notice.



Bulk Cable

Proper cable selection is critical to product performance. Turck offers high quality cables with a wide variety of options to ensure we can provide our customers with the optimal cable solution for their application challenges. Not only do we have cable solutions for flexing, welding, and extreme temperatures, but we also have the capability of utilizing our internal cable design team to create custom cables to fit specific application requirements.

Turck's breadth of standard cable offerings provide UL approved solutions anywhere from 2 to 35 conductors and gauge sizes between 8 to 28 AWG, along with multiple cable jacket material options. Additionally, there are many options for network media cables as well as solutions with foil or braided shielding for RFI and EMI noise immunity.

Standard Cable Types:

- PVC
- TPU
- TPE
- Flexlife®-20
- Extremelife™

PVC Jacketed Cables (page 50)

Turck's PVC (Polyvinyl Chloride) jacketed cables offer the most features and highest quality available in the market while remaining a cost effective solution. These cables carry UL ITC and PLTC listings, are flame retardant to FT4, oil resistant to UL I and II, resistant to many industrial chemicals and solvents, and are sunlight resistant. While these cables are designed for high flex life, they are also flexible for ease of use and installation. Cables are available with Exposed Run (ER) and Direct Burial (DB) listings, meaning they meet the same crush and impact requirements as metal clad cables, but without the weight, size, or expense of metal.

TPU (page 62)

TPU (Thermoplastic Polyurethane) jacketed cables have long been considered the most cut-through and abrasion resistant cables available. Turck offers cables with UL and CSA AWM recognition, -40 °C to + 90 °C operating temperatures with an FT1 flame rating. TPU is highly resistant to oil and lubricants including cutting oils, transmission fluids, and gasoline. These cables offer excellent flex life, and can also be made into retractile cords in a wide variety of lengths and sizes.

TPE (page 66)

Turck's TPE (Thermo-Plastic Elastomer) jacketed cables are robust and reliable in many demanding applications. Very flexible for ease of use, these cables are also oil resistant to UL Oil Res I and II, UV resistant, and are resistant to cut through and abrasion. Turck's TPE jacket material also offers excellent resistance to weld slag buildup. Cables carry UL ITC and PLTC listings and are available with Exposed Run (ER) and Direct Burial (DB) listings, meaning they meet the same crush and impact requirements as metal clad cables, but without the weight, size, or expense of metal.

Flexlife-20 (page 70)

Engineered for robotic, motion systems, and C-tracks, Turck's Flexlife-20 cables are guaranteed* for 20 million flex cycles whether the flexing is a tick-tock motion, torsional bend and flex, or in a C-Track. Available with Turck's TPE jacket material, they are oil resistant, weld spatter resistant and UV resistant.

(*when properly installed)

Extremelife (page 72)

Turck's unique Extremelife-60 cable family is full featured and agency approved for even the harshest applications, including oil and gas, agricultural equipment, construction equipment, or anywhere else extreme conditions require extreme performance. These cables have earned many listings, including UL ITC, PLTC, TC, Exposed Run (ER), Direct Burial (DB), and CSA CIC, CIC/TC. They remain flexible enough to work with at even -40 °C and carry UL -60 °C cold bend and UL/CSA -40 °C cold impact listings. They also are FT 4 flame retardant, UL Oil Resistant I and II, and UV resistant. No other cable family on the market can claim all of these features while also providing a cost effective solution.

Mil-Spec Part Number Cable Code	Total Number of Conductors	Cable Construction (Number of Conductors X AWG)	Cable Jacket Color	Outer Cable Diameter (mm)	Shield	Conductor Colors	Cable Features	Cable Approvals	Voltage Rating	Temperature Rating (°C)	Bulk Cable Part Number
1380	2	2X12	Black	10.0		BK, WH		WT, TC, DB, CIC-TC	1000 V	90 °C	RF51380
1029	2	2X16	Black	7.2		BU, BN	Marine Shipboard, AS-I	ITC-ER, DB, CIC-TC	600 V	105 °C	RF51029
1630	2	2X16	Black	9.6		BK, WH	MSHA	STOOW	600 V	105 °C	RF51630
1300	2	2X16	Black	9.1	Foil, Drain	BU, BN, Drain (18)	Marine Shipboard, Foundation Fieldbus	ITC-ER, DB, CIC-TC	600 V	105 °C	RF51300
0962	2	2X16	Blue	7.2		BU, BN	Marine Shipboard, AS-I	ITC-ER, DB, CIC-TC	600 V	105 °C	RF50962
0852	2	2X16	Yellow	7.2		BU, BN	Marine Shipboard, AS-I	ITC-ER, DB, CIC-TC	600 V	105 °C	RF50852
0561	2	2X16	Yellow	9.6		WH, BK	MSHA	STOOW	600 V	105 °C	RF50561
0891	2	2X16	Yellow	9.1	Foil, Drain	BU, BN, Drain (18)	Marine Shipboard, Foundation Fieldbus	ITC-ER, DB, CIC-TC	600 V	105 °C	RF50891
0864	2	2X18	Black	6.2		BU, BN	MSHA	ITC	600 V	105 °C	RF50864
0860	2	2X18	Black	8.5	Foil, Drain, Braid	BU, BN, Drain (20)	Marine Shipboard, Foundation Fieldbus	ITC-ER, DB, CIC-TC	600 V	105 °C	RF50860
0843	2	2X18	Blue	6.2		BN, BU	MSHA	ITC	600 V	105 °C	RF50843
0786	2	2X18	Blue	8.5	Foil, Drain, Braid	BU, BN, Drain (20)	Marine Shipboard, Foundation Fieldbus	ITC-ER, DB, CIC-TC	600 V	105 °C	RF50786
0511	2	2X18	Yellow	6.2		BN, BU	MSHA	ITC	600 V	105 °C	RF50511
0784	2	2X18	Yellow	8.5	Foil, Drain, Braid	BU, BN, Drain (20)	Marine Shipboard, Foundation Fieldbus	ITC-ER, DB, CIC-TC	600 V	105 °C	RF50784
1418	2	2X20	Black	5.1		BU, BN	MSHA	ITC	300 V	105 °C	RF51418
1658	2	2X20	Black	5.5	Foil, Drain	BK, Drain (22), WH		ITC	600 V	105 °C	RF51658
1923	2	2X20	Blue	5.1		BU, BN		ITC	300 V	105 °C	RF51923
0529	2	2X20	Gray	5.1		BN, BU	MSHA	ITC	300 V	105 °C	RF50529
1551	2	2X22	Black	8.5	Foil, Drain, Braid	Drain (22), GN, RD	Profibus-DP	PLTC-ER, DB	300 V	80 °C	RF51551
1927	2	2X22	Blue	5.1		BU, BN		ITC	600 V	105 °C	RF51927
0650	2	2X22	Yellow	5.1		WH, BK	MSHA	ITC	600 V	105 °C	RF50650
2162	2	2X24	Blue	4.0		BU, BN		AWM	300 V	105 °C	RF52162
1742	3	3X10	Black	12.8		BK, GN, WH		WT, TC-ER, DB, CIC-TC	1000 V	90 °C	RF51742
1851	3	3X12	Black	11.4		BK, GN, WH		WT, TC-ER, DB, CIC-TC	1000 V	90 °C	RF51851
2060	3	3X12	Yellow	11.4		BK, GN, WH		WT, TC-ER, DB, CIC-TC	1000 V	90 °C	RF52060
1364	3	3X14	Black	10.0	Foil, Drain, Braid	BK, Drain (16), GN, WH		WT, TC-ER, DB, CIC-TC	1000 V	90 °C	RF51364
1932	3	3X14	Red	9.6		BK, GN, WH		WT, TC-ER, DB, CIC-TC	1000 V	90 °C	RF51932
2129	3	1STPDX16+1X16	Black	7.9		BU, BN, Drain (18), GN/YE	Marine Shipboard	ITC-ER, DB, CIC-TC	600 V	105 °C	RF52129
1628	3	3X16	Black	10.0		BK, GN, WH	MSHA	STOOW	600 V	105 °C	RF51628
2136	3	1STPX16+1X16	Black	8.4	Foil, Drain	BK, Drain (18), GN, WH		TC-ER, DB, CIC-TC	600 V	105 °C	RF52136

Mil-Spec Part Number Cable Code	Total Number of Conductors	Cable Construction (Number of Conductors X AWG)	Cable Jacket Color	Outer Cable Diameter (mm)	Shield	Conductor Colors	Cable Features	Cable Approvals	Voltage Rating	Temperature Rating (°C)	Bulk Cable Part Number
1327	3	1STPX16+1X16	Blue	7.0	Foil, Drain	BK, Drain (18), GN, WH		ITC	600 V	105 °C	RF51327
0679	3	3X16	Gray	10.0		GN, BK, WH	MSHA	STOOW	600 V	105 °C	RF50679
0536	3	3X16	Yellow	10.0		GN, BK, WH	MSHA	STOOW	600 V	105 °C	RF50536
0537	3	3X16	Yellow	10.0		GN, RD/BK, RD/WH	MSHA	STOOW	600 V	105 °C	RF50537
0817	3	3X18	Black	6.2		RD/BK, RD/WH, GN	MSHA	ITC	600 V	105 °C	RF50817
1330	3	1STPDX18+1X18	Black	7.2		BU, BN, Drain (20), GN/YE	Marine Shipboard	ITC-ER, DB, CIC-TC	600 V	105 °C	RF51330
1646	3	1STPDX18+1X18	Black	7.2		BK, Drain (20), GN/ YE, RD	Marine Shipboard	ITC-ER, DB, CIC-TC	600 V	105 °C	RF51646
1247	3	3X18	Black	6.2		BK, RD, WH		ITC	600 V	105 °C	RF51247
1880	3	3X18	Black	7.2	Foil, Drain	BK, Drain (20), RD, WH		ITC-ER, DB, CIC	300 V	105 °C	RF51880
1335	3	1STPDX18+1X18	Blue	7.2		BU, BN, Drain (20), GN/YE	Marine Shipboard	ITC-ER, DB, CIC-TC	600 V	105 °C	RF51335
1187	3	3X18	Gray	6.2		BK, GN, WH		ITC	600 V	105 °C	RF51187
0567	3	3X18	Gray	5.7		BN, BU, BK		ITC	300 V	105 °C	RF50567
0653	3	3X18	Gray	6.2		BK-1, BK-2, GN/YE		ITC	600 V	105 °C	RF50653
2059	3	1STPDX18+1X18	Yellow	7.2		BU, BN, Drain (20), GN/YE	Marine Shipboard	ITC-ER, DB, CIC-TC	600 V	105 °C	RF52059
1299	3	3X18	Yellow	8.0		BK, GN, WH	MSHA	SJTOW	300 V	105 °C	RF51299
0513	3	3X18	Yellow	6.2		BN, BU, BK	MSHA	ITC	600 V	105 °C	RF50513
0880	3	3X18	Yellow	6.2		BN, BU, GN/YE	MSHA	ITC	600 V	105 °C	RF50880
0520	3	3X18	Yellow	6.2		RD/BK, RD/WH, GN	MSHA	ITC	600 V	105 °C	RF50520
2197	3	3X20	Black	6.2		BK, GN, RD		ITC	600 V	105 °C	RF52197
0795	3	3X20	Black	5.1		BN, BU, BK		ITC	300 V	105 °C	RF50795
1978	3	3X20	Blue	5.3		BK, BU, BN	MSHA	ITC	300 V	105 °C	RF51978
0528	3	3X20	Gray	5.3		BN, BU, BK	MSHA	ITC	300 V	105 °C	RF50528
1926	3	3X20	Gray	5.3		BU, BN, GN/YE		ITC	300 V	105 °C	RF51926
2083	3	3X22	Black	5.1		BK, BU, BN		ITC	300 V	105 °C	RF52083
2081	3	3X22	Gray	5.1		BK, BU, BN	MSHA	ITC	300 V	105 °C	RF52081
1074	3	3X22	Gray	5.1	Foil, Drain, Braid	BK, BU, BN, Drain (24)		ITC	300 V	105 °C	RF51074
0531	3	3X22	Yellow	5.1		GN, RD/BK, RD/WH	MSHA	ITC	300 V	105 °C	RF50531
2087	3	3X22	Yellow	5.1		BK, BU, BN		ITC	300 V	105 °C	RF52087
0535	3	3X22	Yellow	6.2	Braid	GN, RD/BK, RD/WH		ITC	300 V	105 °C	RF50535
0585	3	3X24	Black	4.2		BN, BU, BK	MSHA	AWM	300 V	105 °C	RF50585
1889	3	3X24	Black	5.1	Foil, Drain, Braid	BU, BK, BN, Drain (26)		AWM	300 V	105 °C	RF51889
0752	3	3X24	Gray	4.4		BN, BU, BK		AWM	300 V	105 °C	RF50752
0642	3	3X24	Yellow	4.4		BN, BU, BK	MSHA	AWM	300 V	105 °C	RF50642
1422	3	3X24	Yellow	5.1	Foil, Drain, Braid	BK, BU, BN, Drain (26)		AWM	300 V	105 °C	RF51422
1743	4	4X10	Black	14.9		BK, GN, RD, WH		WT, TC-ER, DB, CIC-TC	1000 V	90 °C	RF51743
1966	4	4X10	Black	16.0	Foil, Drain, Braid	BK, Drain (14), GN, RD, WH		WT, TC-ER, DB, CIC-TC	1000 V	90 °C	RF51966

We reserve the right to make technical alterations without prior notice.

Mil-Spec Part Number Cable Code	Total Number of Conductors	Cable Construction (Number of Conductors X AWG)	Cable Jacket Color	Outer Cable Diameter (mm)	Shield	Conductor Colors	Cable Features	Cable Approvals	Voltage Rating	Temperature Rating (°C)	Bulk Cable Part Number
1850	4	4X12	Black	12.6		BK, GN, RD, WH		WT, TC-ER, DB, CIC-TC	1000 V	90 °C	RF51850
1193	4	4X14	Black	10.0		WH, GN, BK, RD		WT, TC-ER, DB, CIC-TC	1000 V	90 °C	RF51193
1363	4	4X14	Black	10.8	Foil, Drain, Braid	BK, Drain (16), GN, RD, WH		WT, TC-ER, DB, CIC-TC	1000 V	90 °C	RF51363
1454	4	1STPX15+1STPX18	Black	11.2	Foil, Drain, Braid	BK, BU, Drain (18), RD, WH	DeviceNet	PLTC	600 V	80 °C	RF51454
1453	4	1STPX15+1STPX18	Blue	11.2	Foil, Drain, Braid	BK, BU, Drain (18), RD, WH	DeviceNet	PLTC	600 V	80 °C	RF51453
0652	4	1STPX15+1STPX18	Gray	11.2	Foil, Drain, Braid	BK, BU, Drain (18), RD, WH	DeviceNet	PLTC	600 V	80 °C	RF50652
1626	4	4X16	Black	10.8		BK, GN, RD, WH	MSHA	STOOW	600 V	105 °C	RF51626
1655	4	1STPX16+1STPX20	Black	8.4	Foil, Drain	BK, BU, Drain (20), RD, WH	DeviceNet	PLTC	300 V	80 °C	RF51655
2139	4	1STRDX16+1X16	Black	10.8	Foil	BK, Drain (18), GN, RD, WH		TC-ER, DB, CIC-TC	600 V	105 °C	RF52139
0717	4	4X16	Blue	10.8		BK, GN, RD, WH	MSHA	STOOW	600 V	105 °C	RF50717
0721	4	1STPX16+1STPX20	Gray	8.4	Foil, Drain	BK, BU, Drain (20), RD, WH	DeviceNet	PLTC	300 V	80 °C	RF50721
1875	4	4X16	Yellow	8.5		BK, BU, BN, WH	Marine Shipboard, AS-I	ITC-ER, DB, CIC-TC	600 V	105 °C	RF51875
0626	4	4X16	Yellow	10.8		GN/YE, BU, BN, WH	MSHA	STOOW	600 V	105 °C	RF50626
1220	4	4X16	Yellow	9.1		RD, WH, BK, GN		WT, TC-ER, DB, CIC-TC	1000 V	90 °C	RF51220
1249	4	4X16	Yellow	8.4	Foil, Drain, Braid	BK, Drain (18), GN, RD, WH		ITC	600 V	105 °C	RF51249
1456	4	1STPX17+1STPX20	Black	8.9	Foil, Drain	BK, BU, Drain (20), RD, WH	DeviceNet, Flexlife	PLTC	300 V	80 °C	RF51456
1455	4	1STPX17+1STPX20	Blue	8.9	Foil, Drain	BK, BU, Drain (20), RD, WH	DeviceNet, Flexlife	PLTC	300 V	80 °C	RF51455
0876	4	1STPX17+1STPX20	Gray	8.9	Foil, Drain	BK, BU, Drain (20), RD, WH	DeviceNet, Flexlife	PLTC	300 V	80 °C	RF50876
0816	4	4X18	Black	6.7		BK, BU, BN, WH	MSHA	ITC	600 V	105 °C	RF50816
1727	4	4X18	Blue	7.2	Foil, Drain	BK, BU, BN, Drain (20), WH		ITC-ER, DB, CIC	300 V	105 °C	RF51727
1929	4	4X18	Gray	6.7		BK, GN, RD, WH	MSHA	ITC	600 V	105 °C	RF51929
0580	4	4X18	Gray	6.7		BK, BU, WH, BN	MSHA	ITC	600 V	105 °C	RF50580
1693	4	4X18	Yellow	10.2		BK, GN, RD, WH	MSHA	STOOW	600 V	105 °C	RF51693
0548	4	4X18	Yellow	6.7		BK, BU, BN, WH	MSHA	ITC	600 V	105 °C	RF50548
1096	4	4X18	Yellow	7.2	Drain, Braid	BK, BU, BN, Drain (20), WH		ITC	600 V	105 °C	RF51096
0820	4	4X20	Black	6.7	Foil, Drain, Braid	BK, BU, BN, Drain (22), WH		ITC	600 V	105 °C	RF50820
1167	4	4X20	Gray	5.9	Foil, Drain	BK, BU, BN, Drain (22), WH		ITC	300 V	105 °C	RF51167
0983	4	4X22	Black	5.3		BN, WH, BU, BK	MSHA	ITC	300 V	105 °C	RF50983
1452	4	2STPX22	Black	7.2	Foil, Drain	BK, BU, Drain (22), RD, WH	DeviceNet	PLTC	300 V	80 °C	RF51452
0805	4	4X22	Black	5.3	Foil, Drain	BN, WH, BU, BK, Drain (22)		ITC	300 V	105 °C	RF50805
0598	4	4X22	Blue	5.3		BN, WH, BU, BK	MSHA	ITC	300 V	105 °C	RF50598
0516	4	4X22	Gray	5.3		BN, WH, BU, BK	MSHA	ITC	300 V	105 °C	RF50516
0651	4	2STPX22	Gray	7.9	Drain, Braid	BK, BU, Drain (22), RD, WH	DeviceNet	PLTC	600 V	80 °C	RF50651
0577	4	4X22	Gray	5.3	Foil, Drain	BN, WH, BU, BK, Drain (22)		ITC	300 V	105 °C	RF50577
0530	4	4X22	Yellow	5.3		BN, WH, BU, BK	MSHA	ITC	300 V	105 °C	RF50530

Mil-Spec Part Number Cable Code	Total Number of Conductors	Cable Construction (Number of Conductors X AWG)	Cable Jacket Color	Outer Cable Diameter (mm)	Shield	Conductor Colors	Cable Features	Cable Approvals	Voltage Rating	Temperature Rating (°C)	Bulk Cable Part Number
0555	4	4X22	Yellow	5.3		RD/BK, RD/WH, RD, GN	MSHA	ITC	300 V	105 °C	RF50555
0656	4	4X22	Yellow	6.2	Braid	GN, RD, RD/BK, RD/WH		ITC	300 V	105 °C	RF50656
1347	4	2X22+2X24	Yellow	5.1	Foil, Drain, Braid	BK, BU, BN, Drain (24), WH		AWM	300 V	105 °C	RF51347
1045	4	2STPX24	Gray	5.7	Foil, Drain	BK, BU, Drain (24), RD, WH	DeviceNet	AWM	300 V	80 °C	RF51045
1490	4	4X24	Gray	4.4	Foil, Drain	BK, BU, BN, Drain (24), WH		AWM	300 V	105 °C	RF51490
1255	4	4X24	Yellow	3.8		BN, BK, BU, WH		AWM	300 V	105 °C	RF51255
1942	5	5X12	Black	12.7		BK, GN, OG, RD, WH		WT, TC-ER, DB, CIC-TC	1000 V	90 °C	RF51942
1627	5	5X16	Black	12.7		BK, GN, OG, RD, WH	MSHA	STOOW	600 V	105 °C	RF51627
0540	5	5X16	Yellow	12.7		RD/BK, RD/WH, RD/ BU, GN, RD/OG	MSHA	STOOW	600 V	105 °C	RF50540
0539	5	5X16	Yellow	12.7		WH, RD, GN, OG, BK	MSHA	STOOW	600 V	105 °C	RF50539
1324	5	5X18	Black	7.6		BK, BU, BN, GN/ YE, WH	MSHA	ITC	600 V	105 °C	RF51324
1494	5	2STPDX18+1X18	Black	8.5	Foil, Drain	BU, BN, GN/YE, BK, WH, Drain (20), Drain (20), Drain (20)	Marine Shipboard	ITC-ER, DB, CIC-TC	600 V	105 °C	RF51494
0964	5	5X18	Blue	8.5	Foil, Drain	BK, BU, BN, Drain (20), GN/YE, WH	Marine Shipboard	ITC-ER, DB, CIC-TC	600 V	105 °C	RF50964
0695	5	5X18	Gray	7.6		BK, BU, BN, OG, WH	MSHA	ITC	600 V	105 °C	RF50695
0630	5	5X18	Gray	7.6		BK, BU, GN/YE, BN, WH	MSHA	ITC	600 V	105 °C	RF50630
1093	5	5X18	Gray	7.2		BK, BU, BN, GY, WH		AWM	600 V	105 °C	RF51093
1345	5	5X18	Red	7.6		BK, BU, BN, GN/ YE, WH	MSHA	ITC	600 V	105 °C	RF51345
2200	5	1STPDX18+3X14	Red	11.7		*18 = BN, WH, Drain (18), Drain (20)z 14 = GN, RD, BK*		WT, TC-ER, DB, ITC-ER, CIC-TC	1000 V	105 °C	RF52200
1661	5	5X18	Yellow	7.6		BK, GN, OG, RD, WH	MSHA	ITC	600 V	105 °C	RF51661
0549	5	5X18	Yellow	7.6		BK, BU, GN/YE, BN, WH	MSHA	ITC	600 V	105 °C	RF50549
0578	5	5X18	Yellow	7.6		BK, BU, YE, BN, WH	MSHA	ITC	600 V	105 °C	RF50578
1084	5	5X18	Yellow	7.6		BN, BK, WH, GY, BU	MSHA	ITC	600 V	105 °C	RF51084
0521	5	5X18	Yellow	7.6		RD/BU, GN, RD/OG, RD/BK, RD/WH		ITC	600 V	105 °C	RF50521
1835	5	2STPDX18+1X18	Yellow	8.5	Foil, Drain	BU, BN, GN/YE, BK, WH, Drain (20), Drain (20), Drain (20)	Marine Shipboard	ITC-ER, DB, CIC-TC	600 V	105 °C	RF51835
1429	5	5X18	Yellow	8.0	Foil, Drain, Braid	BK, BU, BN, Drain (20), GY, WH		ITC	300 V	105 °C	RF51429
0563	5	1X20+4X22	Gray	6.0		*22 = BU, BN, WH, BK 20 = GN/YE*	MSHA	ITC	300 V	105 °C	RF50563
0618	5	5X20	Gray	6.7		BK, BU, BN, GN/ YE, WH		ITC	600 V	105 °C	RF50618
1679	5	5X20	Gray	7.2	Foil, Drain, Braid	BK, BU, BN, Drain (24), GY, WH		ITC	300 V	105 °C	RF51679
0982	5	5X22	Black	5.7		GN, BN, WH, BU, BK	MSHA	ITC	300 V	105 °C	RF50982
0794	5	5X22	Black	5.7	Foil, Drain	BK, BU, BN, Drain (24), GY, WH		ITC	300 V	105 °C	RF50794
0767	5	5X22	Blue	6.2		WH, BK, GN, RD, OG		ITC	600 V	105 °C	RF50767

We reserve the right to make technical alterations without prior notice.

Mil-Spec Part Number Cable Code	Total Number of Conductors	Cable Construction (Number of Conductors X AWG)	Cable Jacket Color	Outer Cable Diameter (mm)	Shield	Conductor Colors	Cable Features	Cable Approvals	Voltage Rating	Temperature Rating (°C)	Bulk Cable Part Number
0543	5	5X22	Gray	5.7		GY, BN, WH, BU, BK	MSHA	ITC	300 V	105 °C	RF50543
1967	5	2STPD22+1X22	Gray	8.5	Foil, Drain	BU, WH, BK, RD, Drain (22), Drain (22)	CAN	AWM	300 V	80 °C	RF51967
0713	5	5X22	Gray	6.6	Foil, Drain, Braid	BN, WH, BU, BK, GY, Drain (24)		ITC	600 V	105 °C	RF50713
0684	5	5X22	Yellow	5.7		BN, WH, GY, BK, BU	MSHA	ITC	300 V	105 °C	RF50684
0556	5	5X22	Yellow	5.7		RD/BK, RD/WH, RD, GN, RD/YE	MSHA	ITC	300 V	105 °C	RF50556
0756	5	2UTPX22+1X22	Yellow	7.2	Foil, Drain, Braid	BK, BU, BN, Drain (24), GY, WH		ITC	300 V	105 °C	RF50756
1905	5	5X24	Gray	4.8	Foil, Drain, Braid	BN, WH, BU, BK, GY, Drain (26)		AWM	300 V	105 °C	RF51905
1823	5	5X24	Yellow	4.5		BK, BU, BN, GY, WH		AWM	300 V	105 °C	RF51823
1884	6	4X8+2X14	Black	27.6		"14 = BU/YE (-), BU/YE (+) 8 = BK V, BK U, GN/ YE, BK W"		WT, TC-ER, STOOW, CIC-TC	1000 V	90 °C	RF51884
2072	6	4X12+2X14	Black	20.1		"14 = BU/YE (-), BU/ YE (+) 12 = BK V, BK U, GN/ YE, BK W"		WT, TC-ER, STOOW, CIC-TC	1000 V	90 °C	RF52072
1078	6	6X14	Yellow	12.0		WH, RD, GN, OG, BK, BU		ITC	600 V	105 °C	RF51078
1736	6	4X16+1STPD20	Black	9.6	Foil, Drain, Braid	BK, BU, Drain (20), GN, LightBU, LightBU/WH, RD		ITC	600 V	105 °C	RF51736
1909	6	6X16	Blue	10.0		BK, BU, GN, OG, RD, WH	Marine Shipboard	ITC-ER, DB, CIC-TC	600 V	105 °C	RF51909
1329	6	6X16	Blue	9.6	Foil, Drain	BK, BU, Drain (18), GN, OG, RD, WH		ITC	600 V	105 °C	RF51329
1030	6	6X16	Yellow	9.0		GN, BK, WH, RD, OG, BU		ITC	600 V	105 °C	RF51030
1535	6	6X16	Yellow	9.8	Foil, Drain, Braid	BK, BU, Drain (18), GN, OG, RD, WH		ITC	600 V	105 °C	RF51535
1600	6	1STPD18+4X16	Black	12.5		BK, BU, Drain (18), GN, OG, RD, WH	Marine Shipboard, CAN	ITC-ER, DB, CIC-TC	600 V	105 °C	RF51600
1641	6	6X18	Black	8.4		BU, BN, GY, GN, WH, YE	MSHA	ITC	600 V	105 °C	RF51641
0551	6	6X18	Black	8.4	Foil, Drain	BU, WH, BK, GN, RD, OG, Drain (20)	MSHA	ITC	600 V	105 °C	RF50551
2009	6	3STPX18	Black	9.8	Foil, Drain	BK/WH, BU/WH, BN/ WH, Drain (20), WH/ BK, WH/BU, WH/BN		ITC-ER, DB, CIC-TC	600 V	105 °C	RF52009
1588	6	6X18	Blue	8.4	Foil, Drain	BK, BU, Drain (20), GN, OG, RD, WH	MSHA	ITC	600 V	105 °C	RF51588
1662	6	6X18	Yellow	8.4		BK, BU, GN, OG, RD, WH	MSHA	ITC	600 V	105 °C	RF51662
1085	6	6X18	Yellow	8.4		BN, WH, BU, BK, GY, PK		ITC	600 V	105 °C	RF51085
0575	6	6X18	Yellow	8.4		WH, GN, YE, GY, BN, BU		ITC	600 V	105 °C	RF50575
1430	6	6X18	Yellow	7.6	Foil, Drain, Braid	BK, BU, BN, Drain (20), GY, PK, WH		ITC	300 V	105 °C	RF51430
1735	6	1STPD20+4X12	Black	11.3	Foil, Drain, Braid	"12 = GN, RD, BU, BK, Drain (16) 20 = LT BU/WH, LT BU, Drain (22)"		AWM	600 V	105 °C	RF51735
0640	6	6X20	Gray	6.7		BK, BU, GN, OG, RD, WH	MSHA	ITC	300 V	105 °C	RF50640

Mil-Spec Part Number Cable Code	Total Number of Conductors	Cable Construction (Number of Conductors X AWG)	Cable Jacket Color	Outer Cable Diameter (mm)	Shield	Conductor Colors	Cable Features	Cable Approvals	Voltage Rating	Temperature Rating (°C)	Bulk Cable Part Number
1809	6	3UTPX22	Black	9.6	Foil, Drain	RD, GN, BU, GN/WH, BK, WH, Drain (22)		ITC	600 V	105 °C	RF51809
1284	6	6X22	Gray	6.2		BK, BU, BN, GY, PK, WH	MSHA	ITC	300 V	105 °C	RF51284
1964	6	3STPX22	Gray	7.2	Drain, Braid	BK, BU, BN, Drain (24), GY, PK, WH		ITC	300 V	105 °C	RF51964
1003	6	6X22	Yellow	6.2		RD/WH, RD, GN, RD/ YE, RD/BK, RD/BU	MSHA	ITC	300 V	105 °C	RF51003
0758	6	6X24	Black	5.1		BK, BU, BN, GY, PK, WH		AWM	300 V	105 °C	RF50758
0845	6	6X24	Black	5.1	Foil, Drain	WH, GN, YE, GY, BN, BU, Drain (24)		AWM	300 V	105 °C	RF50845
1341	6	2UTPX24+1UTPX22	Black	7.9	Foil, Drain, Braid	BN, Drain (26), GY, GN, RD, WH, YE		AWM	300 V	80 °C	RF51341
0619	6	6X24	Blue	5.1		BK, BU, BN, GY, PK, WH		AWM	300 V	105 °C	RF50619
0608	6	6X24	Gray	5.1		GY, BN, WH, PK, BU, BK		AWM	300 V	105 °C	RF50608
0610	6	6X24	Gray	5.1	Foil, Drain	BK, GY, PK, BN, WH, BU, Drain (24)		AWM	300 V	105 °C	RF50610
0885	6	6X24	Yellow	5.1		BK, BU, BN, GY, PK, WH		AWM	300 V	105 °C	RF50885
1079	7	7X14	Yellow	12.0		WH, RD, OG, BU, WH/BK, BK, GN		ITC	600 V	105 °C	RF51079
1192	7	7X14	Yellow	11.2	Foil, Drain, Braid	WH/BK, BK, WH, RD, OG, BU, GN, Drain (20)		AWM	600 V	105 °C	RF51192
1031	7	7X16	Yellow	9.6		WH/BK, BK, WH, RD, OG, BU, GN		ITC	600 V	105 °C	RF51031
0715	7	7X18	Black	8.4	Foil, Drain	BK, GN, OG, WH/ BK, WH, RD, BU, Drain (20)	MSHA	ITC	600 V	105 °C	RF50715
1086	7	7X18	Yellow	8.1		BU, WH, YE, BN, GY, GN, PK		ITC	600 V	105 °C	RF51086
0637	7	7X18	Yellow	8.4	Foil, Drain	WH, GN, YE, GY, BN, BU, GN/YE, Drain (20)	MSHA	ITC	600 V	105 °C	RF50637
0761	7	7X24	Black	5.1	Foil, Drain	GY, BU, WH, BN, GN, YE, PK, Drain (24)		AWM	300 V	105 °C	RF50761
1625	8	8X16	Black	10.0		BK, BU, GN, OG, RD, RD/BK, WH, WH/BK		ITC	600 V	105 °C	RF51625
1032	8	8X16	Yellow	10.0		OG, BU, WH/BK, BK, WH, RD, GN, RD/BK		ITC	600 V	105 °C	RF51032
0552	8	8X18	Black	8.9	Foil, Drain	WH, BK, GN, RD, OG, BU, BN, YE, Drain (20)	MSHA	ITC	600 V	105 °C	RF50552
1547	8	8X18	Black	10.5	Foil, Drain, Braid	BK, BU, Drain (20), GN, OG, RD, TN, VT, YE	Marine Shipboard	ITC-ER, DB, CIC-TC	600 V	105 °C	RF51547
1087	8	8X18	Yellow	8.9		WH, YE, BN, GY, GN, BU, PK, RD	MSHA	ITC	600 V	105 °C	RF51087
1432	8	8X18	Yellow	9.6	Foil, Drain, Braid	BU, BN, Drain (20), GY, GN, PK, RD, WH, YE		ITC	600 V	105 °C	RF51432
1276	8	4STPDX22	Black	8.5	Drain, Braid	YE/WH, RD/WH, RD, BK, BK/WH, BU/WH, YE, BU, Drain (24), Drain (24), Drain (24), Drain (24)		ITC	300 V	105 °C	RF51276
1644	8	8X22	Black	8.0	Foil, Drain, Braid	BK, BU, Drain (24), GN, OG, RD, TN, VT, YE		ITC	600 V	105 °C	RF51644

We reserve the right to make technical alterations without prior notice.

Mil-Spec Part Number Cable Code	Total Number of Conductors	Cable Construction (Number of Conductors X AWG)	Cable Jacket Color	Outer Cable Diameter (mm)	Shield	Conductor Colors	Cable Features	Cable Approvals	Voltage Rating	Temperature Rating (°C)	Bulk Cable Part Number
1762	8	8X22	Black	8.0	Foil, Drain, Braid	BU, BN, Drain (24), GY, GN, PK, RD, WH, YE		ITC	300 V	105 °C	RF51762
1250	8	8X22	Gray	6.2		BU, BN, GY, GN, PK, RD, WH, YE		ITC	300 V	105 °C	RF51250
1992	8	4STPDX22	Gray	9.3		BK, RD, BK, WH, BK, GN, BK, BU, Drain (22), Drain (22), Drain (22), Drain (22)		ITC	600 V	105 °C	RF51992
1117	8	8X22	Yellow	6.2		BK, BU, BN, GN/YE, OG, OG/BK, VT, WH		ITC	300 V	105 °C	RF51117
1264	8	4STPX24	Black	6.6	Drain, Braid	BU, BN, Drain (24), GY, GN, PK, RD, WH, YE		AWM	300 V	105 °C	RF51264
0930	8	8X24	Black	7.2	Foil, Drain, Braid	BU, BN, Drain (26), GY, GN, PK, RD, WH, YE		AWM	600 V	105 °C	RF50930
0842	8	8X24	Blue	5.7		BU, BN, GY, GN, PK, RD, WH, YE		AWM	300 V	105 °C	RF50842
0753	8	8X24	Gray	5.7		BU, WH, BN, GN, YE, GY, PK, RD		AWM	300 V	105 °C	RF50753
0813	8	8X24	Gray	7.2	Foil, Drain, Braid	BU, WH, BN, GN, YE, GY, PK, RD, Drain (26)		AWM	600 V	105 °C	RF50813
0884	8	8X24	Yellow	5.7		BU, WH, BN, GN, YE, GY, PK, RD		AWM	300 V	105 °C	RF50884
0802	8	4UTPX24	Yellow	7.9	Foil, Drain, Braid	BK, BU, BN, Drain (26), GN, OG, RD, WH, YE		AWM	300 V	105 °C	RF50802
1080	9	3X14+6X18	Yellow	11.2		*14 = BK, GN, BU 18 = RD/BK, GN/BK, WH, RD, WH/BK, OG*		ITC	600 V	105 °C	RF51080
1033	9	9X16	Yellow	11.3		OG, BU, RD/BK, GN/ BK, WH, RD, GN, WH/BK, BK		ITC	600 V	105 °C	RF51033
1489	9	4STPDX18+1X18	Black	12.0	Foil, Drain	BK/WH, Drain (20), GN/WH, GN/YE, OG/WH, RD/WH, WH/BK, WH/GN, WH/OG, WH/RD	Marine Shipboard	ITC-ER, DB, CIC-TC	600 V	105 °C	RF51489
0636	9	9X18	Yellow	9.6	Foil, Drain	WH, GN, YE, GY, PK, RD, BU, BN, GN/YE, Drain (20)	MSHA	ITC	600 V	105 °C	RF50636
0741	9	9X22	Blue	6.9		WH, BK, GN, RD, OG, BU, BN, YE, VT GN/YE, WH/BK, BK/ WH, WH/GN, GN/ WH, WH/RD, RD/ WH, WH/OR, OR/ WH, Drain (22), Drain (22), Drain (22), Drain (22), Drain (22)		ITC	300 V	105 °C	RF50741
0978	9	4STPDX22+1X18	Blue	10.0	Foil, Drain	GN/YE, WH/BK, BK/ WH, WH/GN, GN/ WH, WH/RD, RD/ WH, WH/OR, OR/ WH, Drain (22), Drain (22), Drain (22), Drain (22), Drain (22)		ITC	300 V	105 °C	RF50978
0825	9	4STPDX22+1X18	Gray	10.0	Foil, Drain	GN/YE, WH/BK, BK/ WH, WH/GN, GN/ WH, WH/RD, RD/ WH, WH/OR, OR/ WH, Drain (22), Drain (22), Drain (22), Drain (22), Drain (22)	HART	ITC	300 V	105 °C	RF50825

Mil-Spec Part Number Cable Code	Total Number of Conductors	Cable Construction (Number of Conductors X AWG)	Cable Jacket Color	Outer Cable Diameter (mm)	Shield	Conductor Colors	Cable Features	Cable Approvals	Voltage Rating	Temperature Rating (°C)	Bulk Cable Part Number
1034	10	10X16	Yellow	12.0		OG, BU, WH/BK, RD/ BK, GN/BK, OG/BK, RD, GN, BK, WH		ITC	600 V	105 °C	RF51034
0553	10	10X18	Black	10.8	Foil, Drain	VT, GY, GN, RD, OG, BU, BN, YE, WH, BK, Drain (20)	MSHA	ITC	600 V	105 °C	RF50553
0607	10	10X18.5-DF	Yellow	10.8	Foil, Drain	GN/YE, BN, BU, WH, YE, GN/WH, BN/WH, BU/WH, OG, GY, Drain (20)	MSHA	ITC	600 V	105 °C	RF50607
1046	10	10X22	Gray	8.0	Foil, Drain, Braid	BU, BN, Drain (24), GY, GN, OG, PK, RD, TN, WH, YE	MSHA	ITC	300 V	105 °C	RF51046
1946	10	5UTPX22	Gray	7.9	Foil, Drain, Braid	BK, BK, BK, BK, BK, BU, BN, Drain (24), GN, RD, WH		AWM	300 V	105 °C	RF51946
1076	10	10X24	Black	6.6	Foil, Drain	GN, GY, OG, BU, YE, TN, WH, RD, PK, BN, Drain (26)		AWM	300 V	105 °C	RF51076
0836	10	10X24	Black	6.6	Foil, Drain	GN, GY, VT, BU, YE, BK, WH, RD, PK, BN, Drain (26)		AWM	300 V	105 °C	RF50836
1004	10	10X24	Gray	6.2		OG, RD, BU, PK, GY, YE, GN, BN, WH, TN		AWM	300 V	105 °C	RF51004
1006	10	10X24	Gray	7.2	Foil, Drain, Braid	OG, RD, BU, PK, GY, YE, GN, BN, WH, TN, Drain (26)		AWM	300 V	105 °C	RF51006
1883	11	2UTPX14+7X16	Black	16.5		RD, RD/BK, GN, GN/ BK, YE, BU, BU, GN/ YE, BN, BN, YE		WT, TC-ER, DB, CIC-TC	1000 V	105 °C	RF51883
0716	11	11X18	Black	10.8	Foil, Drain	BK, GN, OG, BU, RD, WH, WH/BK, RD/BK, GN/BK, OG/BK, BU/ BK, Drain (20)	MSHA	ITC	600 V	105 °C	RF50716
2134	11	5STPDX18+1X18	Black	13.2	Foil, Drain	BK/WH, BU/WH, Drain (20), GN/WH, GN/YE, OG/WH, RD/ WH, WH/BK, WH/ BU, WH/GN, WH/ OG, WH/RD		ITC-ER, DB, CIC	300 V	105 °C	RF52134
0624	11	3X18+8X22	Yellow	8.5	Foil, Drain	*18 = BN, BU, GN/YE 22 = WH/GN, GN, GY, WH, RD/BU, YE, GY/PK, BN/GN, Drain (22)*	MSHA	ITC	300 V	105 °C	RF50624
1088	11	11X18	Yellow	10.5	Foil, Drain	WH, GN, YE, GY, PK, RD, BK, VT, BU, BN, GN/YE, Drain (20)	MSHA	ITC	600 V	105 °C	RF51088
2153	11	5STPDX18+1X18	Yellow	13.2	Foil, Drain	BK/WH, BU/WH, Drain (20), GN/WH, GN/YE, OG/WH, RD/ WH, WH/BK, WH/ BU, WH/GN, WH/ OG, WH/RD		ITC-ER, DB, CIC	300 V	105 °C	RF52153
1035	12	12X16	Yellow	12.5		GN, OG, BU, WH/BK, RD/BK, GN/BK, OG/ BK, BU/BK, BK/WH, WH, RD, BK		ITC	600 V	105 °C	RF51035
0606	12	12X18	Yellow	11.2	Foil, Drain	BU/WH, GN/YE, BN, BU, WH, OG, YE, GN/ WH, BN/WH, GY, PK, RD, Drain (20)	MSHA	ITC	600 V	105 °C	RF50606

We reserve the right to make technical alterations without prior notice.

Mil-Spec Part Number Cable Code	Total Number of Conductors	Cable Construction (Number of Conductors X AWG)	Cable Jacket Color	Outer Cable Diameter (mm)	Shield	Conductor Colors	Cable Features	Cable Approvals	Voltage Rating	Temperature Rating (°C)	Bulk Cable Part Number
0821	12	12X22	Black	7.5		BK, BK, BK, BK, BK, BK, BK, BK, BK, BK, BK, GN/YE		ITC	300 V	105 °C	RF50821
0967	12	12X22	Black	7.5	Foil, Drain	RD, PK, YE, GN, WH, BU, BN, OG, BK, GY, TN, VT, Drain (24)		ITC	300 V	105 °C	RF50967
0742	12	12X22	Blue	7.5		BK, BU, BN, GY, GN, OG, PK, RD, TN, VT, WH, YE		ITC	300 V	105 °C	RF50742
1433	12	12X22	Yellow	7.9	Foil, Drain, Braid	BK, BU, BN, Drain (24), GY, GN, OG, PK, RD, TN, VT, WH, YE		ITC	300 V	105 °C	RF51433
0755	12	12X24	Black	6.7	Foil, Drain	RD, GN, OG, TN, GY, VT, YE, BK, WH, BN, BU, PK, Drain (26)		AWM	300 V	105 °C	RF50755
0931	12	12X24	Black	7.2	Foil, Drain, Braid	GY/PK, VT, BK, BN, WH, RD/BU, RD, BU, PK, GY, YE, GN, Drain (26)		AWM	300 V	105 °C	RF50931
1725	12	12X24	Black	7.2	Foil, Drain, Braid	GY, OG, BU, VT, WH/ VT, RD, BK, GN, YE, WH/YE, BN, WH/BN, Drain (26)		AWM	300 V	105 °C	RF51725
0991	12	12X24	Gray	6.3		BN, WH, OG, RD, BU, PK, GY, YE, GN, BK, TN, VT		AWM	300 V	105 °C	RF50991
0988	12	12X24	Gray	7.2	Foil, Drain, Braid	BN, WH, OG, RD, BU, PK, GY, YE, GN, BK, TN, VT, Drain (26)		AWM	300 V	105 °C	RF50988
1349	12	6STPDX24	Gray	8.5	Foil, Drain, Braid	BK/RD, RD, BK/ WH, WH, BK/GN, GN, BK/BU, BU, BK/ YE, YE, BK/BN, BN, Drain (24), Drain (24), Drain (24), Drain (24), Drain (24)		AWM	300 V	105 °C	RF51349
0917	12	12X24	Yellow	6.6	Foil, Drain	BK, RD, GN, GY, PK, RD/BU, GY/PK, BU, VT, WH, YE, BN, Drain (26)		AWM	300 V	105 °C	RF50917
1435	12	12X24	Yellow	7.2	Foil, Drain, Braid	BK, BU, BN, Drain (26), GY, GY/PK, GN, PK, RD, RD/BU, VT, WH, YE		AWM	300 V	105 °C	RF51435
1523	13	4STRDX20+1X22	Black	11.4	Foil, Drain	OG, RD/BU, WH/BU, BK/BU, WH, BK, RD, WH/GN, BK/GN, RD/ GN, BK/YE, RD/YE, WH/YE, Drain (22), Drain (22), Drain (22), Drain (22), Drain (22)		ITC	300 V	105 °C	RF51523
1097	14	14X18	Yellow	11.2		PK, YE, WH, GY/PK, BU, GN, RD/BU, GY, RD, VT, GN/YE, BK, BN/GN, BN		AWM	600 V	105 °C	RF51097
0576	14	14X18	Yellow	11.5	Foil, Drain	GN/YE, GN/WH, BN, BN/WH, BU, BU/ WH, WH, YE, PK, BK, OG, GY, RD, VT, Drain (20)	MSHA	ITC	600 V	105 °C	RF50576

Mil-Spec Part Number Cable Code	Total Number of Conductors	Cable Construction (Number of Conductors X AWG)	Cable Jacket Color	Outer Cable Diameter (mm)	Shield	Conductor Colors	Cable Features	Cable Approvals	Voltage Rating	Temperature Rating (°C)	Bulk Cable Part Number
0998	14	14X22	Black	7.6	Foil, Drain	BN, OG, TN, BU, GN, PK, RD, WH, BK, RD/ BU, GY/BN, YE, GY, VT, Drain (24)		ITC	300 V	105 °C	RF50998
1522	14	14X22	Gray	7.6	Foil, Drain	BK, BU, BN, Drain (24), GY, GY/BN, GN, OG, PK, RD, RD/BU, TN, VT, WH, YE		ITC	300 V	105 °C	RF51522
2065	15	3X18+12X22	Black	8.5	Foil, Drain	BU, BN, BN/GN, Drain (22), GY, GY/ PK, GN, GN/YE, PK, RD, RD/BU, WH, WH/GN, WH/YE, YE, YE/BN	MSHA	ITC	300 V	105 °C	RF52065
0625	15	3X18+12X22	Yellow	8.5	Foil, Drain	*18 = BN, BU, GN/YE, 22 = WH, GN, GY, PK, RD, RD/BU, GY/ PK, WH/GN, BN/GN, WH/YE, YE/BN, YE, Drain (22)*	MSHA	ITC	300 V	105 °C	RF50625
1270	16	16X18	Yellow	13.2	Foil, Drain, Braid	BK, BU, BN, Drain (20), GY, GN, OG, PK, RD, TN, VT, WH, WH/ BK, WH/BU, WH/GN, WH/RD, YE		ITC	600 V	105 °C	RF51270
0744	16	16X22	Blue	8.3		WH, BK, GN, RD, OG, BU, BN, YE, VT, GY, PK, TN, WH/BK, WH/GN, WH/RD, WH/BU		ITC	300 V	105 °C	RF50744
1763	17	8STPDX18+1X18	Black	15.5	Foil, Drain	BK/WH, BU/WH, BN/ WH, Drain (20), GN/ WH, GN/YE, OG/ WH, RD/WH, VT/ WH, WH/BK, WH/ BU, WH/BN, WH/ GN, WH/OG, WH/ RD, WH/VT, WH/YE, YE/WH		ITC-ER, DB, CIC	300 V	105 °C	RF51763
2064	17	8STPDX18+1X18	Yellow	15.5	Foil, Drain	BK/WH, BU/WH, BN/ WH, Drain (20), GN/ WH, GN/YE, OG/ WH, RD/WH, VT/ WH, WH/BK, WH/ BU, WH/BN, WH/ GN, WH/OG, WH/ RD, WH/VT, WH/YE, YE/WH		ITC-ER, DB, CIC	300 V	105 °C	RF52064
1901	17	8STPDX22+1X18	Black	14.9	Foil, Drain	BK/WH, BU/WH, BN/ WH, Drain (22), GN/ WH, GN/YE, OG/ WH, RD/WH, VT/ WH, WH/BK, WH/ BU, WH/BN, WH/ GN, WH/OG, WH/ RD, WH/VT, WH/YE, YE/WH	Marine Shipboard	ITC, CIC	300 V	105 °C	RF51901

We reserve the right to make technical alterations without prior notice.

Mil-Spec Part Number Cable Code	Total Number of Conductors	Cable Construction (Number of Conductors X AWG)	Cable Jacket Color	Outer Cable Diameter (mm)	Shield	Conductor Colors	Cable Features	Cable Approvals	Voltage Rating	Temperature Rating (°C)	Bulk Cable Part Number
0977	17	8STPDX22+1X18	Blue	12.0	Foil, Drain	WH/BK, BK/WH, WH/GN, GN/WH, WH/RD, RD/WH, WH/OG, OG/WH, WH/BU, BU/WH, WH/BN, BN/WH, WH/YE, YE/WH, WH/VT, VT/WH, GN/ YE (18), Drain (22), Drain (22), Drain (22), Drain (22), Drain (22), Drain (22), Drain (22), Drain (22), Drain (22)		ITC	300 V	105 °C	RF50977
1420	18	2STPDX22+14X22	Black	9.6	Foil, Drain, Braid	WH, GN, BU, OG, PK, BK, WH/BN, TN, RD/ YE, RD/GN, RD, RD/ BK, WH/BK, WH/ GN, WH/RD, WH/ YE, WH/BU, WH/OG, Drain (24), Drain (24), Drain (22)		ITC	300 V	105 °C	RF51420
0942	18	18X24	Yellow	7.2	Foil, Drain, Braid	BK, BU, BN, BN/GN, BN/YE, Drain (26), GY, GY/BN, GN, PK, PK/GY, RD, RD/BU, VT, WH, WH/GY, WH/GN, WH/YE, YE		AWM	300 V	105 °C	RF50942
1610	19	19X18	Black	13.0		BK, BU, BN, BN/GN, GY, GY/BN, GY/PK, GN, GN/YE, PK, RD, RD/BU, VT, WH, WH/ GY, WH/GN, WH/YE, YE, YE/BN		ITC-ER, DB, CIC	300 V	105 °C	RF51610
0733	19	3X18+16X22	Black	10.0	Foil, Drain	"18 = BN, BU, GN/YE 22 = WH, GN, YE, GY, PK, RD, BK, VT, GY/ PK, RD/BU, WH/GN, BN/GN, WH/YE, YE/ BN, WH/GY, GY/BN, Drain (20)"	MSHA	ITC	300 V	105 °C	RF50733
0965	19	3X18+16X22	Blue	12.5	Foil, Drain	BK, BU, BN, BN/GN, Drain (20), GY, GY/ BN, GY/PK, GN, GN/ YE, PK, RD, RD/BU, VT, WH, WH/GY, WH/GN, WH/YE, YE, YE/BN	Marine Shipboard	ITC, CIC	300 V	105 °C	RF50965
2062	19	19X18	Yellow	13.0		BK, BU, BN, BN/GN, GY, GY/BN, GY/PK, GN, GN/YE, PK, RD, RD/BU, VT, WH, WH/ GY, WH/GN, WH/YE, YE, YE/BN		ITC-ER, DB, CIC	300 V	105 °C	RF52062
0620	19	3X18+16X22	Yellow	10.0	Foil, Drain	18 = BN, BU, GN/YE,	MSHA	ITC	300 V	105 °C	RF50620
0995	19	19X22	Black	8.5	Foil, Drain	"18 = BN, BU, GN/YE, 22 = GN, WH/YE, PK, BN/GN, BK, WH/ GN, RD/BU, GY/PK, OG, GY, RD, WH, VT, GY/BN, YE, Drain (24)"		ITC	300 V	105 °C	RF50995

Mil-Spec Part Number Cable Code	Total Number of Conductors	Cable Construction (Number of Conductors X AWG)	Cable Jacket Color	Outer Cable Diameter (mm)	Shield	Conductor Colors	Cable Features	Cable Approvals	Voltage Rating	Temperature Rating (°C)	Bulk Cable Part Number
1816	19	19X22	Yellow	8.9	Foil, Drain, Braid	BK, BU, BN, BN/GN, Drain (24), GY, GY/ BN, GY/PK, GN, OG, PK, RD, RD/BU, TN, VT, WH, WH/GN, WH/YE, YE, YE/BN		ITC	300 V	105 °C	RF51816
0631	25	25X22	Yellow	10.0	Foil, Drain	Bn, Bu, WH, Bk, Bn/ Rd, Bu/Rd, WH/Rd, Bk/Rd, Bn/Ye, Bu/Ye, WH/Ye, Bk/Ye, Bn/ Gy, Bu/Gy, WH/Gy, Bk/Gy, Bn/Gn, Bu/ Gn, WH/Gn, Bk/Gn, Bk/Og, WH/Og, Bn/ Og, Bu/Og, Gn/Ye, Drain (22)	MSHA	ITC	300 V	105 °C	RF50631
1061	27	27X22	Yellow	10.5	Foil, Drain	BN, WH/GY, BU/GY, BN/GY, BK/YE, WH/ YE, BU/YE, BN/YE, BK/RD, WH/RD, BU/ RD, BN/RD, BK, WH, BU, BK/GY, BN/OG, WH/OG, BK/OG, BK/ GN, WH/GN, BU/ GN, BN/GN, BU/ OG, GN/YE, GY, OG, Drain (22)	MSHA	ITC	300 V	105 °C	RF51061

We reserve the right to make technical alterations without prior notice.

Mil-Spec Part Number Cable Code	Total Number of Conductors	Cable Construction (Number of Conductors X AWG)	Cable Jacket Color	Outer Cable Diameter (mm)	Shield	Conductor Colors	Cable Features	Cable Approvals	Voltage Rating	Temperature Rating (°C)	Bulk Cable Part Number
2158	2	2X18	Black	5.2		BU, BN		AWM	300 V	105 °C	RF52158
0657	2	2X20	Blue	5.1		BN, BU	MSHA	AWM	600 V	90 °C	RF50657
0772	2	2X20	Gray	4.8		BN, BU		AWM	300 V	90 °C	RF50772
1792	2	2X22	Gray	5.1	Foil, Drain	BU, BN, Drain (24)		AWM	600 V	90 °C	RF51792
1312	2	2X22	Black	5.1	Foil, Drain, Braid	BU, BN, Drain (24)	MSHA	AWM	300 V	90 °C	RF51312
2130	2	2X22	Black	5.1	Foil, Drain, Braid	BK, Drain (24), RD	MSHA	AWM	300 V	90 °C	RF52130
1197	2	2X24	Black	4.2	Foil, Drain	BN, BU, Drain (26)		AWM	300 V	90 °C	RF51197
0669	3	3X18	Gray	6.0		BK-1, BK-2, GN/YE	MSHA	AWM	600 V	90 °C	RF50669
0547	3	3X18	Yellow	5.3		RD/WH, RD/BK, GN	MSHA	AWM	300 V	90 °C	RF50547
0545	3	3X18	Yellow	6.0		BN, BU, GN/YE		AWM	600 V	90 °C	RF50545
0839	3	3X18	Blue	6.0	Foil, Drain	BK, Drain (20), RD, WH		AWM	600 V	90 °C	RF50839
1697	3	3X20	Black	5.1		BK, BU, BN	MSHA	AWM	300 V	90 °C	RF51697
1070	3	3X20	Yellow	6.2	Drain, Braid	BK, BU, BN, Drain (24)		AWM	300 V	80 °C	RF51070
2080	3	3X22	Gray	4.8		BK, BU, BN	MSHA	AWM	300 V	90 °C	RF52080
1343	3	3X22	Yellow	5.1		BU, BN, GN	MSHA	AWM	600 V	90 °C	RF51343
1166	3	3X24	Black	4.4		BN, BU, BK	Flexlife-20, C-Track	AWM	600 V	90 °C	RF51166
1254	3	3X24	Yellow	3.8		BN, BK, BU		AWM	300 V	90 °C	RF51254
0601	3	3X24	Black	4.2	Foil, Drain	BN, BU, BK, Drain (26)		AWM	300 V	90 °C	RF50601
0633	4	1STPX15+1STPX18	Gray	10.4	Foil, Drain, Braid	BK, BU, Drain (18), RD, WH	DeviceNet	AWM	300 V	80 °C	RF50633
0877	4	1STPX17+1STPX20	Gray	8.4	Foil, Drain	BK, BU, Drain (20), RD, WH	DeviceNet, Flexlife	AWM	300 V	80 °C	RF50877
2074	4	1STPX17+1STPX20	Yellow	8.4	Foil, Drain	BK, BU, Drain (20), RD, WH	DeviceNet, Flexlife	AWM	300 V	80 °C	RF52074
0544	4	4X18	Yellow	7.2		BK, BU, BN, WH	MSHA	AWM	600 V	90 °C	RF50544
0840	4	4X18	Blue	6.6	Foil, Drain	BK, Drain (22), GN, RD, WH		AWM	600 V	90 °C	RF50840
1791	4	2STPX18	Blue	6.9	Foil, Drain	BK, BU, BN, Drain (20), WH		AWM	600 V	90 °C	RF51791
1723	4	4X18	Gray	6.6	Foil, Drain	BK, BU, BN, Drain (20), WH		AWM	600 V	90 °C	RF51723
1954	4	4X18	Black	7.2	Foil, Drain, Braid	BK, BU, BN, Drain (22), WH		AWM	600 V	90 °C	RF51954
2109	4	4X20	Black	5.1		BK, BU, BN, WH		AWM	600 V	90 °C	RF52109
1340	4	4X22	Blue	5.1		BK, BU, BN, WH	MSHA	AWM	300 V	90 °C	RF51340
0532	4	4X22	Gray	5.1		BN, WH, BU, BK		AWM	300 V	90 °C	RF50532
0614	4	4X22	Yellow	4.7		RD/BK, RD/WH, RD, GN	MSHA	AWM	300 V	90 °C	RF50614
0613	4	4X22	Yellow	5.1		BN, WH, BU, BK		AWM	300 V	90 °C	RF50613
1734	4	2STPX22	Black	6.2	Foil, Drain	BK, BU, BN, Drain (24), WH		AWM	300 V	90 °C	RF51734
2154	4	4X22	Black	6.9	Foil, Drain	BK, BU, BN, Drain (22), WH		AWM	600 V	90 °C	RF52154
0701	4	4X22	Gray	5.7	Foil, Drain	BK, Drain (24), GN, RD, WH		AWM	600 V	90 °C	RF50701
1069	4	2STPX22	Gray	6.2	Foil, Drain	2 pair = (BN, BK), (WH, BU), Drain (24)		AWM	300 V	90 °C	RF51069
1404	4	4X22	Yellow	3.8	Foil, Drain	BK, BU, BN, Drain (26), WH		AWM	300 V	80 °C	RF51404

Mil-Spec Part Number Cable Code	Total Number of Conductors	Cable Construction (Number of Conductors X AWG)	Cable Jacket Color	Outer Cable Diameter (mm)	Shield	Conductor Colors	Cable Features	Cable Approvals	Voltage Rating	Temperature Rating (°C)	Bulk Cable Part Number
0810	4	4X22	Gray	6.2	Foil, Drain, Braid	BN, WH, BU, BK, Drain (22)		AWM	600 V	90 °C	RF50810
1746	4	2X22+2X24	Yellow	5.1	Foil, Drain, Braid	BK, BU, BN, Drain (24), WH		AWM	300 V	90 °C	RF51746
1477	4	4X24	Black	3.8		BK, BU, BN, WH		AWM	300 V	90 °C	RF51477
1256	4	4X24	Yellow	3.8		BN, BK, BU, WH		AWM	300 V	90 °C	RF51256
0935	4	4X26	Black	4.4		BN, WH, BU, BK	Flexlife-20, C-Track	AWM	600 V	90 °C	RF50935
1481	5	5X16	Yellow	8.0		BK, GN, OG, RD, WH		AWM	600 V	90 °C	RF51481
1914	5	5X18	Black	7.2		BK, BU, BN, GN/ YE, WH	MSHA	AWM	600 V	90 °C	RF51914
1656	5	5X18	Gray	7.2		BK, BU, BN, GY, WH		AWM	600 V	90 °C	RF51656
0751	5	5X18	Yellow	7.2		WH, BK, BU, GN/ YE, BN	MSHA	AWM	600 V	90 °C	RF50751
2073	5	3X18+2X20	Gray	7.2	Foil, Drain	BK, BK/WH, BU, BN, Drain (20), GN/YE		AWM	600 V	90 °C	RF52073
1521	5	3X20+1STPDX24	Black	6.7	Braid	BK, BU, Drain (24), RD, RD/BK, WH		AWM	300 V	80 °C	RF51521
0649	5	5X22	Gray	5.3		GY, BN, WH, BU, BK	MSHA	AWM	300 V	90 °C	RF50649
1552	5	5X22	Yellow	5.3		BK, BU, BN, GY, WH		AWM	300 V	90 °C	RF51552
1507	5	5X22	Black	5.7	Foil, Drain, Braid	BK, BU, BN, Drain (24), GY, WH		AWM	300 V	90 °C	RF51507
1856	5	5X24	Black	4.5		BK, BU, BN, GY, WH		AWM	300 V	90 °C	RF51856
0928	5	5X24	Blue	5.7	Foil, Drain	BU, OG, RD, YE, BK, Drain (24)	MSHA	AWM	600 V	90 °C	RF50928
1137	6	6X16	Yellow	9.0		BK, WH, RD, OG, BU, GN		AWM	600 V	90 °C	RF51137
0662	6	6X18	Yellow	6.7	Foil, Drain	WH, GN, YE, GY, BN, BU, Drain (20)		AWM	300 V	90 °C	RF50662
2088	6	1UTPX20+4X20	Black	7.1		BK, BU, GN, OG, RD, YE		AWM	300 V	80 °C	RF52088
0728	6	6X24	Black	5.1		GY, BN, WH, PK, BU, BK	MSHA	AWM	300 V	90 °C	RF50728
0646	6	6X24	Gray	5.1		GY, BN, WH, PK, BU, BK	MSHA	AWM	300 V	90 °C	RF50646
1120	6	6X24	Yellow	6.2	Braid	BN, WH, PK, BU, BK, GY		AWM	300 V	90 °C	RF51120
1541	6	3STPX24	Black	7.2	Drain, Braid	BU/WH, Drain (24), GN/WH, OG/WH, WH/BU, WH/GN, WH/OG		AWM	300 V	80 °C	RF51541
1082	6	6X26	Black	5.1		BN, WH, BU, BK, GY, PK	Flexlife-20, C-Track	AWM	600 V	90 °C	RF51082
1138	7	7X16	Yellow	9.0		BK, WH, RD, OG, BU, GN, WH/BK		AWM	600 V	90 °C	RF51138
0676	7	7X18	Yellow	6.7	Foil, Drain	WH, GN, YE, GY, BN, BU, GN/YE, Drain (20)	MSHA	AWM	300 V	90 °C	RF50676
2179	7	7X20	Black	6.6		BU/BK, GN/BK, OG/ BK, RD, RD/BK, WH/ BK, YE/BK		AWM	300 V	80 °C	RF52179
1139	8	8X16	Yellow	10.0		BU, WH/BK, BK, WH, RD, RD/BK, GN, OG		AWM	600 V	90 °C	RF51139
1680	8	8X24	Black	5.7		BU, BN, GY, GN, PK, RD, WH, YE	MSHA	AWM	300 V	90 °C	RF51680
0984	8	8X24	Gray	5.7		BU, WH, BN, GN, YE, GY, PK, RD	MSHA	AWM	300 V	90 °C	RF50984
1994	8	8X24	Yellow	5.7		BU, BN, GY, GN, PK, RD, WH, YE	MSHA	AWM	300 V	90 °C	RF51994

We reserve the right to make technical alterations without prior notice.

Mil-Spec Part Number Cable Code	Total Number of Conductors	Cable Construction (Number of Conductors X AWG)	Cable Jacket Color	Outer Cable Diameter (mm)	Shield	Conductor Colors	Cable Features	Cable Approvals	Voltage Rating	Temperature Rating (°C)	Bulk Cable Part Number
2123	8	8X24	Black	5.7	Foil, Drain, Braid	BU, BN, Drain (26), GY, GN, PK, RD, WH, YE	Low Smoke Zero Halogen	AWM	300 V	80 °C	RF52123
1616	8	4STPX24	Black	7.5	Foil, Drain, Braid	BU, BN, Drain (24), GY, GN, PK, RD, WH, YE	MSHA	AWM	300 V	90 °C	RF51616
1140	9	9X16	Yellow	10.5		BU, RD/BK, GN/BK, WH, RD, GN, BK, WH/BK, OG		AWM	600 V	90 °C	RF51140
0677	9	9X18	Yellow	9.6	Foil, Drain	WH, GN, YE, GY, PK, RD, BU, BN, GN/YE Drain (20)	MSHA	AWM	600 V	90 °C	RF50677
1141	10	10X16	Yellow	12.0		BU, WH/BK, RD/BK, GN/BK, OG/BK, RD, GN, OG, BK, WH		AWM	600 V	90 °C	RF51141
1319	10	1UTPX18+4UTPX22	Gray	8.4	Foil, Drain	BU, BU/WH, BN, BN/ WH, Drain (22), GY, GN/WH, OG, PK, WH, YE		AWM	300 V	90 °C	RF51319
1005	10	10X24	Gray	6.2		OG, RD, BU, PK, GY, YE, GN, BN, WH, TN	MSHA	AWM	300 V	90 °C	RF51005
0730	11	11X18	Black	10.0	Foil, Drain	BK, BU, BN, Drain (20), GY, GN, GN/YE, PK, RD, VT, WH, YE	MSHA	AWM	600 V	90 °C	RF50730
0718	11	3X18+8X22	Yellow	8.4	Foil, Drain	"18 = BN, BU, GN/YE 22 = WH/GN, GN, GY, WH, RD/BU, YE, GY/PK, BN/GN, Drain (22)"	MSHA	AWM	300 V	90 °C	RF50718
0678	11	11X18	Yellow	10.0	Foil, Drain	WH, GN, YE, GY, PK, RD, BK, VT, BU, BN, GN/YE Drain (20)	MSHA	AWM	600 V	90 °C	RF50678
1142	12	12X16	Yellow	12.4		OG, BU, WH/BK, RD/ BK, GN/BK, OG/BK, BU/BK, BK/WH, GN, WH, RD, BK		AWM	600 V	90 °C	RF51142
2180	12	1UTPX20+10X20	Black	8.9		BK, BN, BN/WH, GY, GN, GN/BK, OG, OG/ BK, RD, RD/BK, YE, YE/BK		AWM	300 V	80 °C	RF52180
1001	12	12X22	Black	7.6	Foil, Drain	RD, PK, YE, GN, WH, BU, BN, OG, BK, GY, TN, VT, Drain (24)		AWM	300 V	90 °C	RF51001
0990	12	12X24	Gray	6.0		BN, WH, OG, RD, BU, PK, GY, YE, GN, BK, TN, VT		AWM	300 V	90 °C	RF50990
1002	14	14X22	Black	7.6	Foil, Drain	BN, OG, TN, BU, GN, PK, RD, WH, BK, RD/ BU, GY/BN, YE, GY, VT, Drain (24)	MSHA	AWM	300 V	90 °C	RF51002
1436	14	14X22	Yellow	8.1	Foil, Drain, Braid	BK, BU, BN, Drain (24), GY, GY/BN, GN, OG, PK, RD, RD/BU, TN, VT, WH, YE		AWM	300 V	90 °C	RF51436
2181	16	1UTPX20+14X20	Black	10.0		BK, BU, BU/BK, BN, BN/WH, GY, GN, GN/BK, OG, OG/BK, RD, RD/BK, WH, WH/ BK, YE, YE/BK		AWM	300 V	80 °C	RF52181

Mil-Spec Part Number Cable Code	Total Number of Conductors	Cable Construction (Number of Conductors X AWG)	Cable Jacket Color	Outer Cable Diameter (mm)	Shield	Conductor Colors	Cable Features	Cable Approvals	Voltage Rating	Temperature Rating (°C)	Bulk Cable Part Number
0933	16	8STPX22	Yellow	9.4	Foil, Drain	BK/WH, BU/WH, BN/WH, Drain (22), GN/WH, OG/WH, RD/WH, VT/WH, WH/BK, WH/BU, WH/BN, WH/GN, WH/OG, WH/RD, WH/VT, WH/YE, YE/WH		AWM	300 V	90 °C	RF50933
0682	19	3X18+16X22	Yellow	10.0	Foil, Drain	*18 = BN, BU, GN/YE 22 =WH, GN, YE, GY, PK, RD, BK, VT, RD/BU, GY/PK, WH/GN, BN/GN, WH/YE, YE/BN, WH/GY, GY/BN, Drain (20)*	MSHA	AWM	300 V	90 °C	RF50682
0996	19	19X22	Black	8.4	Foil, Drain	BN, TN, BU, YE/BN, GN, WH/YE, PK, BN/GN, BK, WH/GN, RD/BU, GY/PK, OG, GY, RD, WH, VT, GY/BN, YE, Drain (24)		AWM	300 V	90 °C	RF50996
1640	19	19X22	Yellow	8.9	Foil, Drain, Braid	BK, BU, BN, BN/GN, Drain (24), GY, GY/BN, GY/PK, GN, OG, PK, RD, RD/BU, TN, VT, WH, WH/GN, WH/YE, YE, YE/BN	MSHA	AWM	300 V	90 °C	RF51640
0926	20	20X18	Yellow	13.7		WH, GN, YE, PK, RD, BK, VT, BU, GY, BN, GY/BN, YE/BN, GN/YE, GY/PK, RD/BU, BN/GN, WH/GN, WH/YE, WH/GY	Flexlife-20, C-Track	AWM	600 V	90 °C	RF50926
1381	25	25X22	Yellow	10.0	Foil, Drain, Braid	BK, BK/GY, BK/GN, BK/OG, BK/RD, BK/YE, BU, BU/GY, BU/GN, BU/OG, BU/RD, BU/YE, BN, BN/GY, BN/GN, BN/OG, BN/RD, BN/YE, Drain (24), GN/YE, WH, WH/GY, WH/GN, WH/OG, WH/RD, WH/YE		AWM	300 V	90 °C	RF51381

We reserve the right to make technical alterations without prior notice.

Mil-Spec Part Number Cable Code	Total Number of Conductors	Cable Construction (Number of Conductors X AWG)	Cable Jacket Color	Outer Cable Diameter (mm)	Shield	Conductor Colors	Cable Features	Cable Approvals	Voltage Rating	Temperature Rating (°C)	Bulk Cable Part Number
1808	2	2X16	Black	8.0	Foil, Drain	BK, Drain (16), RD		WT, TC-ER, DB, ITC, CIC-TC	1000 V	90 °C	RF51808
1770	2	2X18	Black	7.8	Foil, Drain, Braid	BK, Drain (20), RD		WT, TC-ER, DB, CIC-TC	1000 V	90 °C	RF51770
1872	2	2X18	Yellow	7.2	Foil, Drain, Braid	BU, BN, Drain (22)	Flexlife	ITC	600 V	105 °C	RF51872
1945	2	2X20	Blue	5.3	Foil, Drain	BU, BN, Drain (22)	Weldlife	AWM	300 V	80 °C	RF51945
1115	2	2X24	Blue	5.1	Foil, Drain	BU, BN, Drain (24)	Weldlife	AWM	300 V	105 °C	RF51115
1943	3	3X8	Black	17.2		BK, GN, WH		WT, TC-ER, DB, CIC-TC	1000 V	90 °C	RF51943
1667	3	3X10	Black	17.7		BK, GN, WH		WT, TC-ER, DB, STOOW, CIC-TC	1000 V	90 °C	RF51667
1669	3	3X12	Black	16.3		BK, GN, WH		WT, TC-ER, DB, STOOW, CIC-TC	1000 V	90 °C	RF51669
1198	3	3X14	Black	9.6		WH, GN, BK		WT, TC-ER, DB, CIC-TC	1000 V	90 °C	RF51198
0645	3	3X16	Black	10.0		BK, GN, WH		SEOOW	600 V	105 °C	RF50645
1767	3	3X16	Gray	10.0		GN, BK, WH		SEOOW	600 V	105 °C	RF51767
1563	3	3X16	Yellow	10.0		GN, BK, WH		SEOOW	600 V	105 °C	RF51563
2145	3	3X18	Black	7.6		BK, GN, WH		WT, TC-ER, DB, ITC-ER, CIC-TC	1000 V	90 °C	RF52145
2196	3	3X18	Black	5.3		BK, BU, BN	Weldlife	AWM	300 V	105 °C	RF52196
0957	3	3X18	Yellow	6.2		RD/BK, RD/WH, GN		ITC	600 V	105 °C	RF50957
1876	3	3X20	Black	5.3		BK, BU, BN	Weldlife	AWM	300 V	105 °C	RF51876
1266	3	3X22	Gray	5.1		BK, BU, BN		ITC	300 V	105 °C	RF51266
1271	3	3X24	Yellow	4.4		BN, BU, BK	Weldlife	AWM	300 V	105 °C	RF51271
1279	4	4X8	Black	18.8		RD, GN, BK, WH		WT, TC-ER, DB, CIC-TC	1000 V	90 °C	RF51279
1313	4	4X8	Yellow	20.1	Braid	WH, BK, RD, GN		WT, TC-ER, DB, CIC-TC	1000 V	90 °C	RF51313
1666	4	4X10	Black	19.2		BK, GN, RD, WH		WT, TC-ER, DB, STOOW, CIC-TC	1000 V	90 °C	RF51666
1828	4	4X10	Black	14.2	Foil, Drain	BK, GN, RD, WH		WT, TC-ER, DB, CIC-TC	1000 V	90 °C	RF51828
1668	4	4X12	Black	17.7		BK, GN, RD, WH		WT, TC-ER, DB, STOOW, CIC-TC	1000 V	90 °C	RF51668
2124	4	4X12	Black	15.9	Foil, Drain, Braid	BN, Drain (12), GN/ YE, OG, YE	VFD	WT, TC-ER, DB, CIC-TC	1000 V	90 °C	RF52124
1748	4	4X14	Black	10.0		BK, BK, BK, GN/YE		WT, TC-ER, DB, CIC-TC	1000 V	90 °C	RF51748
1672	4	4X14	Black	15.4		BK, GN, RD, WH		WT, TC-ER, DB, STOOW, CIC-TC	1000 V	90 °C	RF51672
2102	4	4X14	Black	11.7	Foil, Drain, Braid	BU, Drain (14), GN/ YE, RD, WH	VFD	WT, TC-ER, DB, CIC-TC	1000 V	90 °C	RF52102
2188	4	4X14	Black	11.7	Foil, Drain, Braid	BK, Drain (14), GN/ YE, RD, WH	VFD	WT, TC-ER, DB, CIC-TC	1000 V	90 °C	RF52188
1231	4	1STPX15+1STPX18	Gray	10.5	Foil, Drain, Braid	BK, BU, Drain (18), RD, WH	DeviceNet	AWM	600 V	80 °C	RF51231
1706	4	4X16	Yellow	10.8		BK, GN, RD, WH		SEOOW	600 V	105 °C	RF51706
1719	4	4X16	Yellow	9.1		BU, BN, GN/YE, WH		WT, TC-ER, DB, CIC-TC	1000 V	90 °C	RF51719

Mil-Spec Part Number Cable Code	Total Number of Conductors	Cable Construction (Number of Conductors X AWG)	Cable Jacket Color	Outer Cable Diameter (mm)	Shield	Conductor Colors	Cable Features	Cable Approvals	Voltage Rating	Temperature Rating (°C)	Bulk Cable Part Number
1235	4	1STPX16+1STPX20	Gray	9.6	Drain, Braid	BK, BU, Drain (20), RD, WH	DeviceNet, Flexlife	AWM	300 V	80 °C	RF51235
1829	4	4X16	Black	9.1	Foil, Drain	BK, Drain (18), GN, RD, WH		WT, TC-ER, DB, CIC-TC	1000 V	90 °C	RF51829
1487	4	4X16	Yellow	9.6	Foil, Drain, Braid	BK, Drain (18), GN, RD, WH		WT, TC-ER, DB, CIC-TC	1000 V	90 °C	RF51487
1936	4	4X18	Black	5.7		BK, BU, BN, WH	Weldlife	AWM	300 V	105 °C	RF51936
2146	4	4X18	Black	8.3		BK, GN, RD, WH		WT, TC-ER, DB, ITC-ER, CIC-TC	1000 V	90 °C	RF52146
0956	4	4X18	Yellow	6.9		BK, BU, BN, WH		ITC	600 V	105 °C	RF50956
1888	4	1STPX18+1STPX22	Black	7.2	Foil, Drain, Braid	BK, BU, Drain (22), RD, WH	DeviceNet	AWM	300 V	80 °C	RF51888
1947	4	4X22	Black	5.3		BK, BU, BN, WH		ITC	300 V	105 °C	RF51947
1396	4	4X22	Gray	5.7		BK, BU, BN, WH		ITC	600 V	105 °C	RF51396
1132	4	4X22	Yellow	5.3		BK, BN, WH, BU		ITC	300 V	105 °C	RF51132
1754	4	2STPDX22	Gray	9.3	Braid	BU, WH, BK, RD, Drain (22), Drain (22)	DeviceNet, Flexlife	ITC	600 V	105 °C	RF51754
2041	4	2STPDX22	Yellow	9.3	Braid	BU, WH, BK, RD, Drain (22), Drain (22)	DeviceNet, Flexlife	ITC	600 V	105 °C	RF52041
1604	4	2UTPX22	Green	7.8	Braid, Foil	BU, OG, WH, YE	Profinet, CAT5E, Solid Wires	ITC	600 V	80 °C	RF51604
1216	4	2UTPX22	Green	8.1	Braid, Foil	BU, OG, WH, YE	Profinet, CAT5E, Stranded Wires, Flexlife	ITC	600 V	80 °C	RF51216
2071	4	2UTPX22	Teal	8.1	Braid, Foil	GN/WH, OG, WH/ GN, WH/OG	Ethernet, CAT5E, Stranded Wires, Flexlife	ITC	600 V	80 °C	RF52071
1296	4	2STPX22	Gray	8.5	Drain, Braid	BK, BU, Drain (22), RD, WH	DeviceNet, Flexlife	AWM	600 V	80 °C	RF51296
1569	4	2X22+2X24	Yellow	5.7	Foil, Drain, Braid	BK, BU, BN, Drain (24), WH	Weldlife	AWM	300 V	105 °C	RF51569
2110	4	2UTPX24	Blue	6.1		GN, OG, WH/GN, WH/OG	Ethernet, CAT5E, Stranded Wires	CM	600 V	80 °C	RF52110
2115	4	2UTPX24	Red	6.1		GN, OG, WH/GN, WH/OG	Ethernet, CAT5E, Stranded Wires	CM	600 V	80 °C	RF52115
1212	4	2UTPX24	Teal	5.6		GN, OG, WH/GN, WH/OG	Ethernet, CAT5E, Solid Wires	CM	300 V	75 °C	RF51212
1210	4	2UTPX24	Teal	6.1		GN, OG, WH/GN, WH/OG	Ethernet, CAT5E, Stranded Wires	CM	600 V	80 °C	RF51210
1211	4	2UTPX24	Teal	6.7	Braid, Foil	OG, WH/OG, GN, WH/GN	Ethernet, CAT5E, Stranded Wires, Flexlife	CM	600 V	80 °C	RF51211
1213	4	2UTPX24	Teal	6.9	Foil, Drain, Braid	Drain (24), GN, OG, WH/GN, WH/OG	Ethernet, CAT5E, Solid Wires	CM	600 V	80 °C	RF51213
1959	5	5X12	Black	12.8	Foil, Drain	BK, BU, Drain (16), GN/YE, RD, WH/BU		WT, TC-ER, DB, ITC-ER, CIC-TC	1000 V	105 °C	RF51959
1886	5	5X14	Black	12.0	Foil, Drain, Braid	BU, BN, Drain (18), GN/YE, OG, WH		WT, TC-ER, DB, ITC-ER, CIC-TC	1000 V	90 °C	RF51886
2128	5	5X16	Gray	12.7		BK, BU, GN, RD, WH		WT, TC-ER, DB, STOOW, CIC-TC	1000 V	90 °C	RF52128
1840	5	5X16	Red	10.0		BK, GN, OG, RD, WH		WT, TC-ER, DB, CIC-TC	1000 V	90 °C	RF51840
1715	5	5X16	Yellow	10.0		BK, GN, OG, RD, WH		WT, TC-ER, DB, CIC-TC	1000 V	90 °C	RF51715
1265	5	5X16	Yellow	12.7		WH, RD, GN, OG, BK		SEOOW	600 V	105 °C	RF51265
1720	5	5X18	Yellow	7.6		BK, BU, BN, GY, WH		ITC	600 V	105 °C	RF51720

We reserve the right to make technical alterations without prior notice.

Mil-Spec Part Number Cable Code	Total Number of Conductors	Cable Construction (Number of Conductors X AWG)	Cable Jacket Color	Outer Cable Diameter (mm)	Shield	Conductor Colors	Cable Features	Cable Approvals	Voltage Rating	Temperature Rating (°C)	Bulk Cable Part Number
0958	5	5X18	Yellow	7.6		RD/BU, GN, RD/OG, RD/BK, RD/WH		ITC	600 V	105 °C	RF50958
1898	5	5X22	Yellow	5.7		BK, BU, BN, GY, WH		ITC	300 V	105 °C	RF51898
1963	6	4X10+2X14	Black	20.6		*14 = BU/YEL (-), BU/YE (+) 10 = BK V, BK U, GN/ YE, BK W*		WT, TC-ER, DB, STOOW, CIC-TC	1000 V	90 °C	RF51963
1059	6	6X12	Yellow	14.7		BK, RD, BU, OG, YE, BN		WT, TC-ER, DB, CIC-TC	1000 V	90 °C	RF51059
1716	6	6X16	Yellow	11.1		BK, BU, GN, OG, RD, WH		WT, TC-ER, DB, CIC-TC	1000 V	90 °C	RF51716
1564	6	6X16	Yellow	13.6		WH, RD, GN, OG, BK, BU		SEOOW	600 V	105 °C	RF51564
2132	6	6X18	Black	9.6		BK, BU, GN, OG, RD, WH		WT, TC-ER, DB, ITC-ER, CIC-TC	1000 V	90 °C	RF52132
1274	6	6X18	Gray	7.9		GN, YE, GY, BN, BU, WH		ITC	300 V	105 °C	RF51274
1009	7	7X16	Yellow	9.6		BK, WH, RD, OG, BU, GN, WH/BK		ITC	600 V	105 °C	RF51009
1314	8	4X8+4X18	Black	18.8		*8 = WH, RD, GN, BK 18 = BU, BN, WH, BK*		WT, TC-ER, DB, CIC-TC	1000 V	90 °C	RF51314
1287	8	4X12+4X18	Yellow	13.2		*12= BU, GN, WH, BK 18= OG, RD, WH/BK, RD/BK*		WT, TC-ER, DB, CIC-TC	1000 V	90 °C	RF51287
1011	8	8X16	Yellow	10.0		BU, WH/BK, BK, WH, RD, RD/BK, GN, OG		ITC	600 V	105 °C	RF51011
2156	8	8X18	Black	10.2		BK, BU, GN, OG, RD, RD/BK, WH, WH/BK		WT, TC-ER, DB, ITC-ER, CIC-TC	1000 V	90 °C	RF52156
1692	8	8X18	Black	11.2	Foil, Drain, Braid	BK, BU, BN, Drain (20), OG, RD, TN, VT, YE		WT, TC-ER, DB, ITC-ER, CIC-TC	1000 V	105 °C	RF51692
2113	8	4UTPX22	Teal	8.8	Braid, Foil	BU, BN, GN/WH, OG, WH/BU, WH/BN, WH/GN, WH/OG	Ethernet, CAT5E, Stranded Wires, Flexlife	ITC	600 V	80 °C	RF52113
2151	8	4UTPX24	Red	6.3		BU, BN, GN, OG, WH/BU, WH/BN, WH/GN, WH/OG	Flexlife, Ethernet, CAT5E, Stranded Wires	CM	600 V	80 °C	RF52151
1462	8	4UTPX24	Teal	6.1		BU, BN, GN, OG, WH/BU, WH/BN, WH/GN, WH/OG	Ethernet, CAT5E, Solid Wires	CM	300 V	75 °C	RF51462
1460	8	4UTPX24	Teal	6.3		BU, BN, GN, OG, WH/BU, WH/BN, WH/GN, WH/OG	Flexlife, Ethernet, CAT5E, Stranded Wires	CM	600 V	80 °C	RF51460
2173	8	8X24	Yellow	5.7		BU, BN, GY, GN, PK, RD, WH, YE	Weldlife	AWM	300 V	105 °C	RF52173
1624	8	4UTPX24	Black	7.7	Braid, Foil	BU, BN, GN, OG, WH/BU, WH/BN, WH/GN, WH/OG	Flexlife, Ethernet, CAT5E, Stranded Wires	CM	600 V	80 °C	RF51624
1348	8	4UTPX24	Gray	7.7	Braid, Foil	BU, BN, GN, OG, WH/BU, WH/BN, WH/GN, WH/OG	Flexlife, Ethernet, CAT5E, Stranded Wires	CM	600 V	80 °C	RF51348
0893	8	4UTPX24	Teal	7.7	Braid, Foil	BU, BN, GN, OG, WH/BU, WH/BN, WH/GN, WH/OG	Flexlife, Ethernet, CAT5E, Stranded Wires	CM	600 V	80 °C	RF50893
1756	8	4STPX24	Black	6.7	Foil, Drain	BU, BN, Drain (26), GY, GN, PK, RD, WH, YE	Weldlife	AWM	600 V	105 °C	RF51756
1757	8	4UTPX24	Black	6.2	Foil, Drain	BU, BN, Drain (26), GY, GN, PK, RD, WH, YE	Weldlife	AWM	600 V	105 °C	RF51757

Mil-Spec Part Number Cable Code	Total Number of Conductors	Cable Construction (Number of Conductors X AWG)	Cable Jacket Color	Outer Cable Diameter (mm)	Shield	Conductor Colors	Cable Features	Cable Approvals	Voltage Rating	Temperature Rating (°C)	Bulk Cable Part Number
1463	8	4UTPX24	Teal	7.2	Foil, Drain, Braid	BU, BN, Drain (24), GN, OG, WH/BU, WH/BN, WH/GN, WH/OG	Ethernet, CAT5E, Solid Wires	CM	600 V	80 °C	RF51463
1013	9	9X16	Yellow	11.2		BU, RD/BK, GN/BK, WH, RD, GN, BK, WH/BK, OG		ITC	600 V	105 °C	RF51013
1751	10	10X16	Yellow	14.2		BK, BU, GN, GN/BK, OG, OG/BK, RD, RD/ BK, WH, WH/BK		WT, TC-ER, DB, CIC-TC	1000 V	90 °C	RF51751
1714	12	12X16	Yellow	14.6		BK, BK/WH, BU, BU/ BK, GN, GN/BK, OG, OG/BK, RD, RD/BK, WH, WH/BK		WT, TC-ER, DB, CIC-TC	1000 V	90 °C	RF51714
2157	12	12X18	Black	12.2		BK, BK/WH, BU, BU/ BK, GN, GN/BK, OG, OG/BK, RD, RD/BK, WH, WH/BK		WT, TC-ER, DB, ITC-ER, CIC-TC	1000 V	90 °C	RF52157
1691	12	1STPDX18+10X18	Black	13.2	Foil, Drain, Braid	BK/OG, BK/YE, BU/ BK, BU/RD, BN/BK, BN/OG, Drain (20), OG/BK, OG/WH, RD/BK, RD/WH, VT/ WH, YE/BK		WT, TC-ER, DB, ITC-ER, CIC-TC	600 V	105 °C	RF51691

We reserve the right to make technical alterations without prior notice.

Flexlife-20

Mil-Spec Part Number Cable Code	Total Number of Conductors	Cable Construction (Number of Conductors X AWG)	Cable Jacket Color	Outer Cable Diameter (mm)	Shield	Conductor Colors	Cable Features	Cable Approvals	Voltage Rating	Temperature Rating (°C)	Bulk Cable Part Number
1351	2	2X18	Black	5.7		BK, WH	C-Track	AWM	600 V	105 °C	RF51351
1173	3	3X18	Yellow	5.7		BN, BU, GN/YE	C-Track	AWM	600 V	105 °C	RF51173
2085	3	3X22	Gray	4.8		BK, BU, BN	C-Track	AWM	300 V	105 °C	RF52085
1690	4	4X16	Yellow	7.2		BU, BN, GN/YE, WH	C-Track	AWM	600 V	105 °C	RF51690
0968	4	4X18	Yellow	6.2		BK, BU, WH, BN	C-Track	AWM	600 V	105 °C	RF50968
0941	4	4X22	Gray	5.1		BN, WH, BU, BK	C-Track	AWM	600 V	105 °C	RF50941
1174	5	5X18	Yellow	6.7		BK, BU, GN/YE, BN, WH	C-Track	AWM	600 V	105 °C	RF51174
0909	5	5X22	Gray	5.1		GY, BN, WH, BU, BK	C-Track	AWM	600 V	105 °C	RF50909
1044	6	6X16	Yellow	8.5		BK, WH, RD, OG, BU, GN	C-Track	AWM	600 V	105 °C	RF51044
1111	6	6X24	Black	5.1		GN, YE, GY, BN, BU, WH	C-Track	AWM	600 V	105 °C	RF51111
0910	6	6X24	Gray	5.1		GY, BN, WH, PK, BU, BK	C-Track	AWM	600 V	105 °C	RF50910
1049	7	7X16	Yellow	9.6		BK, WH, RD, OG, GN, BU, WH/BK	C-Track	AWM	600 V	105 °C	RF51049
1149	7	7X18	Yellow	7.8		BK, WH, RD, OG, BU, GN, WH/BK	C-Track	AWM	600 V	105 °C	RF51149
1050	8	8X16	Yellow	10.5		RD, GN, OG, BU, WH/BK, BK, RD/ BK, WH	C-Track	AWM	600 V	105 °C	RF51050
0911	8	8X24	Gray	6.2		BU, WH, BN, GN, YE, GY, PK, RD	C-Track	AWM	600 V	105 °C	RF50911
1148	12	12X16	Yellow	13.7		OG, BU, WH/BK, RD/ BK, GN/BK, OG/BK, BU/BK, BK/WH, GN, WH, RD, BK	C-Track	AWM	600 V	105 °C	RF51148
0915	12	12X18	Yellow	11.2		BU/WH, GN/YE, BN, BU, WH, OG, YE, GN/ WH, BN/WH, GY, PK, RD	C-Track	AWM	600 V	105 °C	RF50915
0999	12	12X22	Black	8.0		RD, PK, YE, GN, WH, BU, BN, OG, BK, GY, TN, VT	C-Track	AWM	600 V	105 °C	RF50999
0943	12	12X24	Black	7.6		RD, GN, OG, TN, GY, VT, YE, BK, WH, BN, BU, PK	C-Track	AWM	600 V	105 °C	RF50943
1000	15	15X22	Black	9.0		BN, OG, TN, BU, GN, PK, RD, WH, BK, RD/BU, GY/BN, YE, GY, VT	C-Track	AWM	600 V	105 °C	RF51000
1958	19	19X22	Black	9.6		BK, BU, BN, BN/ GN, GY, GY/BN, GY/ PK, GN, OG, PK, RD, RD/BU, TN, VT, WH, WH/GN, WH/YE, YE, YE/BN	C-Track	AWM	600 V	105 °C	RF51958
2066	20	20X18	Black	13.7		BK, BU, BN, BN/GN, GY, GY/BN, GY/PK, GN, GN/YE, PK, RD, RD/BU, VT, WH, WH/ GY, WH/GN, WH/RD, WH/YE, YE, YE/BN	C-Track	AWM	600 V	105 °C	RF52066
0916	21	3X18+18X22	Yellow	11.2		"18 = BN, BU, GN/YE 22 = WH, GN, YE, GY, PK, RD, BK, VT, GY/ PK, RD/BU, WH/GN, BN/GN, WH/YE, YE/ BN, WH/GY, GY/BN"	C-Track	AWM	600 V	105 °C	RF50916

Mil-Spec Part Number Cable Code	Total Number of Conductors	Cable Construction (Number of Conductors X AWG)	Cable Jacket Color	Outer Cable Diameter (mm)	Shield	Conductor Colors	Cable Features	Cable Approvals	Voltage Rating	Temperature Rating (°C)	Bulk Cable Part Number
2067	30	30X22	Black	12.0		WH 1, WH 2, WH 3, WH 4, WH 5, YE 6, YE 7, YE 8, YE 9, YE 10, PK 11, PK 12, PK 13, PK 14, PK 15, OG 16, OG 17, OG 18, OG 19, OG 20, LT BU 21, LT BU 22, LT BU 23, LT BU 24, LT BU 25, LT GN 26, LT GN 27, LT GN 28, LT GN 29, LT GN 30	C-Track	AWM	600 V	105 °C	RF52067
2028	35	35X20	Black	16.5		WH 1, WH 2, WH 3, WH 4, WH 5, YE 6, YE 7, YE 8, YE 9, YE 10, PK 11, PK 12, PK 13, PK 14, PK 15, OG 16, OG 17, OG 18, OG 19, OG 20, LT BU 21, LT BU 22, LT BU 23, LT BU 24, LT BU 25, LT GN 26, LT GN 27, LT GN 28, LT GN 29, LT GN 30, TN 31, TN 32, TN 33, TN 34, TN 35	C-Track	AWM	600 V	105 °C	RF52028

We reserve the right to make technical alterations without prior notice.

Mil-Spec Part Number Cable Code	Total Number of Conductors	Cable Construction (Number of Conductors X AWG)	Cable Jacket Color	Outer Cable Diameter (mm)	Shield	Conductor Colors	Cable Features	Cable Approvals	Voltage Rating	Temperature Rating (°C)	Bulk Cable Part Number
1188	3	1STPDX18+1X18	Black	8.5		BU, BN, Drain (20), GN/YE	Foundation Fieldbus	TC-ER, ITC- ER, CIC-TC, DB	600 V	-60 °C to 105 °C	RF51188
1833	3	3X18	Black	7.2	Foil, Drain	BK, Drain (20), GN, WH		ITC-ER, CIC	300 V	-60 °C to 105 °C	RF51833
1376	3	1STPDX18+1X18	Yellow	8.5		BU, BN, Drain (20), GN/YE	Foundation Fieldbus	TC-ER, ITC- ER, CIC-TC, DB	600 V	-60 °C to 105 °C	RF51376
1699	3	3X22	Gray	6.3		BK, BU, BN		ITC-ER, CIC	300 V	-60 °C to 105 °C	RF51699
2010	4	1STPX16+1STPX18	Black	13.5	Foil, Drain, Braid	BK, BU, Drain (18), RD, WH	DeviceNet	TC-ER, ITC, CIC-TC, DB	600 V	-60 °C to 105 °C	RF52010
2183	4	4X16	Yellow	10.0		BK, GN, RD, WH		TC-ER, DB, ITC-ER, DB, CIC-TC, DB	600 V	-60 °C to 105 °C	RF52183
1783	4	2STPX18	Black	8.5	Foil, Drain	BK, Drain (20), GN, RD, WH		ITC-ER, CIC	300 V	-60 °C to 105 °C	RF51783
1095	4	4X22	Black	6.9	Foil, Drain	BK, BU, BN, Drain (22), WH		ITC-ER, DB, CIC	300 V	-60 °C to 105 °C	RF51095
1696	5	2STPDX18+1X18	Black	10.4	Foil, Drain	GN, WH, GN/YE, BK, RD, Drain (20), Drain (20), Drain (20)	Foundation Fieldbus	TC-ER, DB, ITC, CIC-TC, DB	600 V	-60 °C to 105 °C	RF51696
2176	5	2STPDX18+1X18	Black	10.4	Foil, Drain	BU, BN, GN/YE, BK, WH, Drain (22), Drain (22), Drain (22)	Foundation Fieldbus	TC-ER, DB, ITC, CIC-TC, DB	600 V	-60 °C to 105 °C	RF52176
2111	5	2STPDX18+1X18	Gray	10.4	Foil, Drain	BK, WH, GN/YE, RD, GN, Drain (22), Drain (22), Drain (22)	Foundation Fieldbus	TC-ER, DB, ITC, CIC-TC, DB	600 V	-60 °C to 105 °C	RF52111
2175	5	2STPDX20+1X20	Black	8.1	Foil, Drain	BK, WH, GN/YE, RD, GN, Drain (22), Drain (22), Drain (22)		ITC-ER, DB, CIC	300 V	-60 °C to 105 °C	RF52175
2174	5	2STPDX20+1X20	Blue	8.1	Foil, Drain	BK, WH, GN/YE, RD, GN, Drain (22), Drain (22), Drain (22)		ITC-ER, DB, CIC	300 V	-60 °C to 105 °C	RF52174
2189	6	1UTPX20	Black	10.2		BK, GY, GN, RD, WH, YE		ITC-ER, DB, CIC	300 V	-60 °C to 105 °C	RF52189
1158	8	4STPDX18	Black	13.2	Foil, Drain	BU, RD, YE, BN, GY, GN, BK, WH, Drain (20), Drain (20), Drain (20), Drain (20)	Foundation Fieldbus	TC-ER, DB, ITC-ER, DB, CIC-TC, DB	600 V	-60 °C to 105 °C	RF51158
1780	8	4STPX18	Black	12.5	Foil, Drain	BK, BU, BN, Drain (20), GY, GN, RD, WH, YE		ITC-ER, DB, CIC	300 V	-60 °C to 105 °C	RF51780
1879	8	4STPDX20	Black	10.4	Foil, Drain	GN, BU, BN, WH, YE, OG, BK, RD, Drain (22), Drain (22), Drain (22), Drain (22), Drain (22)		ITC-ER, DB	300 V	-60 °C to 105 °C	RF51879
1189	9	4STPDX18+1X18	Black	13.2	Foil, Drain	BK/WH, Drain (20), GN/WH, GN/YE, OG/WH, RD/WH, WH/BK, WH/GN, WH/OG, WH/RD	Foundation Fieldbus	TC-ER, DB, ITC, CIC-TC, DB	600 V	-60 °C to 105 °C	RF51189
1483	9	4STPDX22+1X18	Black	9.6	Foil, Drain	BK/WH, Drain (22), GN/WH, GN/YE, OG/WH, RD/WH, WH/BK, WH/GN, WH/OG, WH/RD		ITC-ER, DB, CIC	300 V	-60 °C to 105 °C	RF51483

Mil-Spec Part Number Cable Code	Total Number of Conductors	Cable Construction (Number of Conductors X AWG)	Cable Jacket Color	Outer Cable Diameter (mm)	Shield	Conductor Colors	Cable Features	Cable Approvals	Voltage Rating	Temperature Rating (°C)	Bulk Cable Part Number
2186	17	8STPDX18+1X18	Black	19.8	Foil, Drain	BK/WH, BU/WH, BN/WH, Drain (20), GN/WH, GN/YE, OG/WH, RD/WH, VT/WH, WH/BK, WH/BU, WH/BN, WH/GN, WH/OG, WH/RD, WH/VT, WH/YE, YE/WH	Foundation Fieldbus	TC-ER, DB, ITC, CIC-TC, DB	600 V	-60 °C to 105 °C	RF52186
1484	17	8STPDX22+1X18	Black	13.7	Foil, Drain	BK/WH, BU/WH, BN/WH, Drain (22), GN/WH, GN/YE, OG/WH, RD/WH, VT/WH, WH/BK, WH/BU, WH/BN, WH/GN, WH/OG, WH/RD, WH/VT, WH/YE, YE/WH		ITC-ER, DB, CIC	300 V	-60 °C to 105 °C	RF51484
2168	17	8STPDX22+1X18	Blue	13.7	Foil, Drain	BK/WH, BU/WH, BN/WH, Drain (22), GN/WH, GN/YE, OG/WH, RD/WH, VT/WH, WH/BK, WH/BU, WH/BN, WH/GN, WH/OG, WH/RD, WH/VT, WH/YE, YE/WH		ITC-ER, DB, CIC	300 V	-60 °C to 105 °C	RF52168
2194	19	19X20	Black	15.9		BK, BU, BN, BN/GN, GY, GY/BN, GY/PK, GN, GN/YE, PK, RD, RD/BU, VT, WH, WH/GY, WH/GN, WH/YE, YE, YE/BN		ITC-ER, DB, CIC	300 V	-60 °C to 105 °C	RF52194

We reserve the right to make technical alterations without prior notice.

Cable Construction Definitions

STP	Shielded twisted pair
STPD	Shielded twisted pair with drain wire
STRD	Shielded triad with drain wire
UTP	Untwisted pair

Cable Approval Definitions

AWM	Appliance wiring material
CIC	Control and instrumentation cable
CIC-TC	Control and instrumentation cable tray cable
CM	Communications cable
DB	Direct burial
ITC	Instrument tray cable
ITC-ER	Instrument tray cable exposed run
PLTC	Power limited tray cable
PLTC-ER	Power limited tray cable with exposed run
SEOOW	Service grade thermoplastic elastomer cable (600 V) with oil resistant jacket/ conductor insulation and weather proof
SJTOOW	Service junior thermoplastic grade cable (300 V) with oil resistant jacket/conductor insulation and weather proof
STOOW	Service grade thermoplastic cable (600 V) with oil resistant jacket/conductor insulation and weather proof
TC	Tray cable
TC-ER	Tray cable exposed run
WT	Wind turbine cable

Warranty Terms and Conditions

RISK OF LOSS

Delivery of the equipment to a common carrier shall constitute delivery to the Purchaser and the risk of loss shall transfer at that time to Purchaser. Should delivery be delayed due to an act or omission on the part of the Purchaser, risk of loss shall transfer to the Purchaser upon notification by Turck Inc. that the order is complete and ready for shipment.

WARRANTIES

Turck Inc. (hereinafter "Turck") offers five (5) WARRANTIES to cover all products sold. They are as follows:

- 1) The **12-MONTH WARRANTY** is available for the products listed - generally those not covered by **LIFETIME, 5-YEAR, 24-MONTH or 18-MONTH** warranty. No registration required.
- 2) The **18-MONTH WARRANTY** is available for the products listed - generally those not covered by **LIFETIME or 5-YEAR WARRANTY**. No registration is required.
- 3) The **24-MONTH WARRANTY** is available for the products listed - generally those not covered by **LIFETIME, 5-YEAR or 18-MONTH**. No registration is required.
- 4) The **5-YEAR WARRANTY** is available generally for the products listed. No registration is required.
- 5) A **LIFETIME WARRANTY** is available for the products listed. It becomes effective when the accompanying **TURCK LIFETIME WARRANTY REGISTRATION** is completed and returned to Turck.

GENERAL TERMS AND CONDITIONS FOR ALL WARRANTIES

- **12-MONTH STANDARD WARRANTY**
- **18-MONTH STANDARD WARRANTY**
- **24-MONTH STANDARD WARRANTY**
- **5-YEAR WARRANTY**
- **LIFETIME WARRANTY**

Turck warrants the Products covered by the respective WARRANTY AGREEMENTS to be free from defects in material and workmanship under normal and proper usage for the respective time periods listed above from the date of shipment from Turck. In addition, certain specific terms apply to the various WARRANTIES.

THESE EXPRESS WARRANTIES ARE IN LIEU OF AND EXCLUDE ALL OTHER REPRESENTATIONS MADE - BOTH EXPRESSED AND IMPLIED. THERE ARE NO WARRANTIES OF MERCHANTABILITY OR OF FITNESS FOR A PARTICULAR PURPOSE FOR PRODUCTS COVERED BY THESE TERMS AND CONDITIONS.

Turck warrants that the goods sold are as described, but no promise, description, affirmation of fact, sample model or representation, oral or written shall be part of an order, unless set forth in these terms and conditions, or are in writing and signed by an authorized representative of Turck. These WARRANTIES do not apply to any Product which has been subject to misuse, negligence, or accident - or to any Product which has been modified or repaired, improperly installed, altered, or disassembled - except according to Turck's written instructions.

These WARRANTIES are subject to the following conditions:

- 1) These WARRANTIES are limited to the electronic and mechanical performance only, as expressly detailed in the Product specifications and NOT to cosmetic performance.
- 2) These WARRANTIES shall not apply to any cables attached to, or integrated with the Product. However, the **18-MONTH WARRANTY** shall apply to cables sold separately by Turck.
- 3) These WARRANTIES shall not apply to any Products which are stored, or utilized, in harsh environmental or electrical conditions outside Turck's written specifications.
- 4) The WARRANTIES are applicable only to Products shipped from Turck subsequent to January 1, 1988.

ADDITIONAL SPECIFIC TERMS FOR:

(12-MONTH STANDARD WARRANTY) for Linear Displacement Transducers, EZ Track, RFID Products, Draw Wire Assemblies and Slip Rings.

(18-MONTH STANDARD WARRANTY) FOR Q-TRACK INDUCTIVE SENSORS, ULTRASONIC SENSORS, FLOW SENSORS, PRESSURE SENSORS, TEMPERATURE SENSORS, INCLINOMETERS, CABLES AND ALL NON-SENSING PRODUCTS SOLD BY TURCK INC. INCLUDING MULTI-SAFE, MULTI-MODUL, MULTI-CART AND RELATED AMPLIFIER PRODUCTS, RELAYS AND TIMERS.

(24-MONTH STANDARD WARRANTY) FOR ENCODERS excluding Draw Wire Assemblies.

5-YEAR WARRANTY FOR INDUCTIVE AND CAPACITIVE PROXIMITY SENSORS: The periods covered for the above WARRANTIES and Products shall be 12 MONTHS, 18-MONTHS, 24-MONTHS and 5-YEARS, respectively, from the date of shipment from Turck.

LIFETIME WARRANTY (OPTIONAL - REGISTRATION REQUIRED) FOR INDUCTIVE, INDUCTIVE MAGNET OPERATED AND CAPACITIVE PROXIMITY SENSORS SOLD TO THE ORIGINAL PURCHASER FOR THE LIFETIME OF THE ORIGINAL APPLICATION.

THE FOLLOWING TERMS APPLY TO THE LIFETIME WARRANTY IN ADDITION TO THE GENERAL TERMS:

- 1) This WARRANTY shall be effective only when the LIFETIME WARRANTY REGISTRATION has been completed, signed by the End User and an authorized Turck Representative or Distributor and has been received by Turck no later than six (6) months after installation in the End User's Plant, or two (2) years from the date product was shipped from Turck, whichever is sooner.
- 2) This warranty is available only to Turck's authorized Representatives, Distributors and to the Original User. (The term "Original User" means that person, firm, or corporation which first uses the Product on a continuous basis in connection with the operation of a production line, piece of machinery, equipment, or similar device.) In the event the ownership of the product is transferred to a person, firm or corporation other than the Original User, this WARRANTY shall terminate.
- 3) This WARRANTY is applicable only to the Original Application. In the event the machinery, equipment, or production line to which the Product is connected, or on which it is installed, is substituted, changed, moved or replaced, the WARRANTY shall terminate.
- 4) This WARRANTY shall be valid only if the Product was purchased by the Original User from Turck, or from an authorized Turck Distributor, or was an integral part of a piece of machinery and equipment obtained by the Original user from an Original Equipment Manufacturer, which itself, was purchased directly from Turck or from an authorized Distributor.

PURCHASER'S REMEDIES

This Remedy shall apply to all WARRANTIES. If a Turck Distributor desires to make a WARRANTY Claim, the Distributor shall, if requested by Turck, ship the Product to Turck's factory in Minneapolis, Minnesota, postage or freight prepaid. If the User desires to make a WARRANTY Claim, they shall notify the authorized Turck Distributor from whom it was purchased or, if such Distributor is unknown, shall notify Turck. Turck shall, at its option, take any of the following two courses of action for any products which Turck determines are defective in materials or workmanship.

- 1) Repair or replace the Product and ship the Product to the Original Purchaser or to the authorized Turck Distributor, postage or freight prepaid; or
- 2) Repay to the Original Purchaser that price paid by the Original Purchaser; provided that if the claim is made under the LIFETIME WARRANTY, and such Product is not then being manufactured by Turck, then the amount to be repaid by Turck to the Original Purchaser shall be reduced according to the following schedule:

<u>Number of Years Since Date of Purchase by Original Purchaser</u>	<u>Percent of Original Purchase Price To Be Paid by Turck</u>
10	50%
15	25%
20	10%
More than 20	5%

PURCHASER'S REMEDIES SHALL BE LIMITED EXCLUSIVELY TO THE RIGHT OF REPLACEMENT, REPAIR OR REPAYMENT AS PROVIDED AND DOES NOT INCLUDE ANY LABOR COST OR REPLACEMENT AT ORIGINAL PURCHASER'S SITE. TURCK SHALL NOT BE LIABLE FOR ANY CONSEQUENTIAL DAMAGES RESULTING FROM ANY BREACH OF ANY WARRANTY, EXPRESSED OR IMPLIED, APPLICABLE TO THE PRODUCT, INCLUDING WITHOUT LIMITATION, ANY DAMAGES RESULTING FROM PROPERTY DAMAGE, PERSONAL INJURY OR BUSINESS INTERRUPTION.

CONSIDER SAFETY AND PROTECTION PRECAUTIONS

Turck takes great care to design and build reliable and dependable products, however, some products can fail eventually. You must take precautions to design your equipment to prevent property damage and personal injury in the unlikely event of failure. As a matter of policy, Turck does NOT recommend the installation of electronic controls as the sole device FOR THE PROTECTION OF PERSONNEL in connection with power driven presses, brakes, shears and similar equipment and, therefore, the customer should build in redundancy or dual control using approved safety devices for these applications.

Turck Inc. sells its products through Authorized Distributors. These distributors provide our customers with technical support, service and local stock. Turck distributors are located nationwide – including all major metropolitan marketing areas.

For Application Assistance or for the location of your nearest Turck distributor, call:

1-800-544-7769

Specifications in this manual are subject to change with out notice. Turck also reserves the right to make modifications and makes no guarantee of the accuracy of the information contained herein.

Literature and Media questions or concerns?
Contact Turck USA Marketing – info@turck.com

TURCK

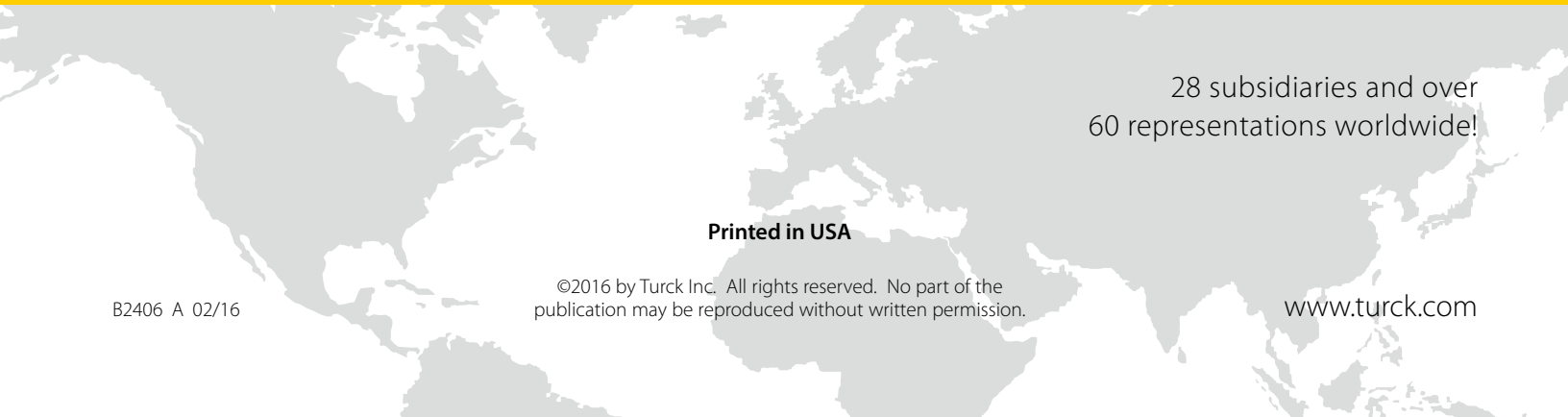

28 subsidiaries and over
60 representations worldwide!

Printed in USA

©2016 by Turck Inc. All rights reserved. No part of the
publication may be reproduced without written permission.

B2406 A 02/16

www.turck.com