



Index

Product	Page
SNAPConnect® Toggle and Decorator Series	
SNAPConnect® Toggle Series	D-4
SNAPConnect® Decorator Series	D-5
HBL® Extra Heavy Duty Industrial Grade	
Toggle and Locking Type Switches with Ground Screw	D-6
Toggle Type Illuminated and Pilot Light Switches with Ground Screw	D-7
3-Position, 2-Circuit Center Off Switches	D-7
Hubbell-PRO Heavy Duty Industrial Series	
Toggle Switches	D-8
Pre-Wired/Leaded Switches	D-8
Hospital Call Switch with Lanyard	D-8
Pre-Wired/Leaded Commercial Toggle and Decorator Switches	
Specification Grade Commercial Switches	
Style Line® Decorator Series Specification Grade	
Extra Heavy Duty Industrial 347V AC Toggle and PresSwitch®	
Switch Accessories	
Pilot Light, SWITCHOUT® Lockout Device and Weatherproof Switch Plates for Toggle Switches	D-13
Switch Certification Chart	
Nylon and Metal Wallplates	
Dimmers	
Slide and Rotary Control Dimmers	D-16
Dimmer Ganging and Derating	D-17
Heavy Duty Panel Mount and Bat Handle Switches	
Technical Information	

SNAPConnect® Switches



Toggle Switches

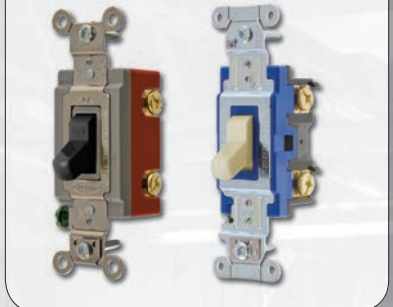

Pre-Wired/Leaded Switches

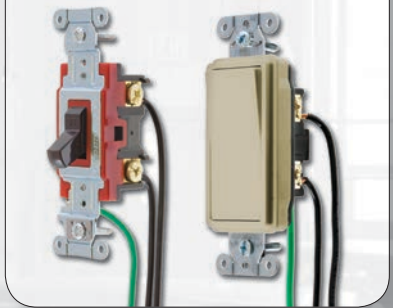

PresSwitch® and
Panel Mount Switches

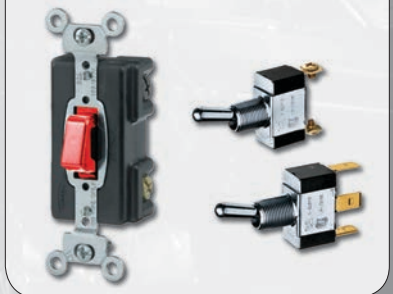

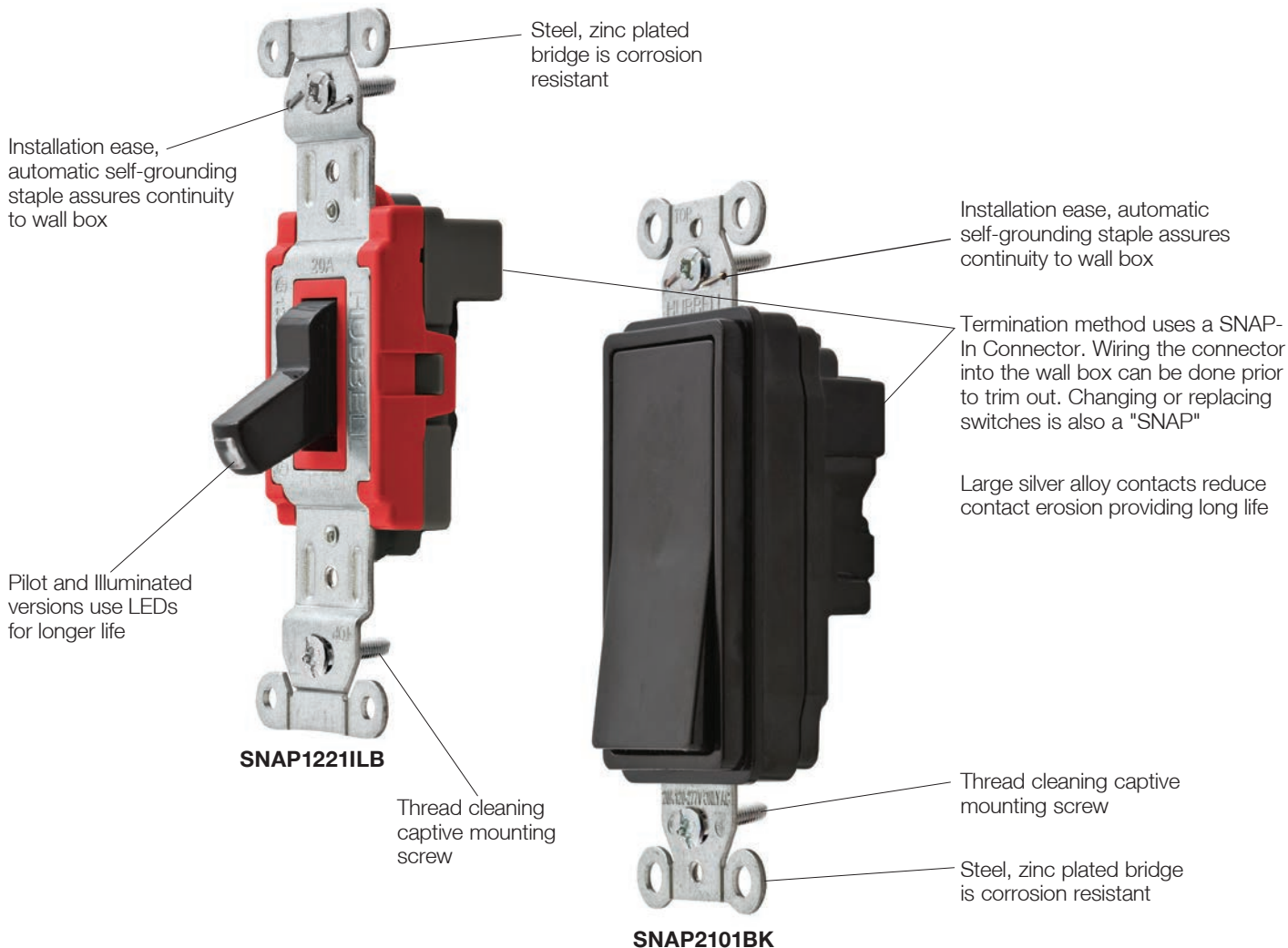

Many of these products are Assembled in USA, as indicated, and many are Buy American Compliant. Please contact Hubbell with any certification requirements.



3 Wire Connector for Single Pole and Single Pole Illuminated

SNAPSP1NA
SNAPSP2NA



4 Wire Connector for Single Pole Pilot Light Switch

SNAPSP1NA
SNAPSP2NA



4 Wire Connector for Three Way and Three Way Illuminated

SNAP3W1NA
SNAP3W2NA

Switches
HBL® Extra Heavy Duty Industrial Grade
Features and Benefits

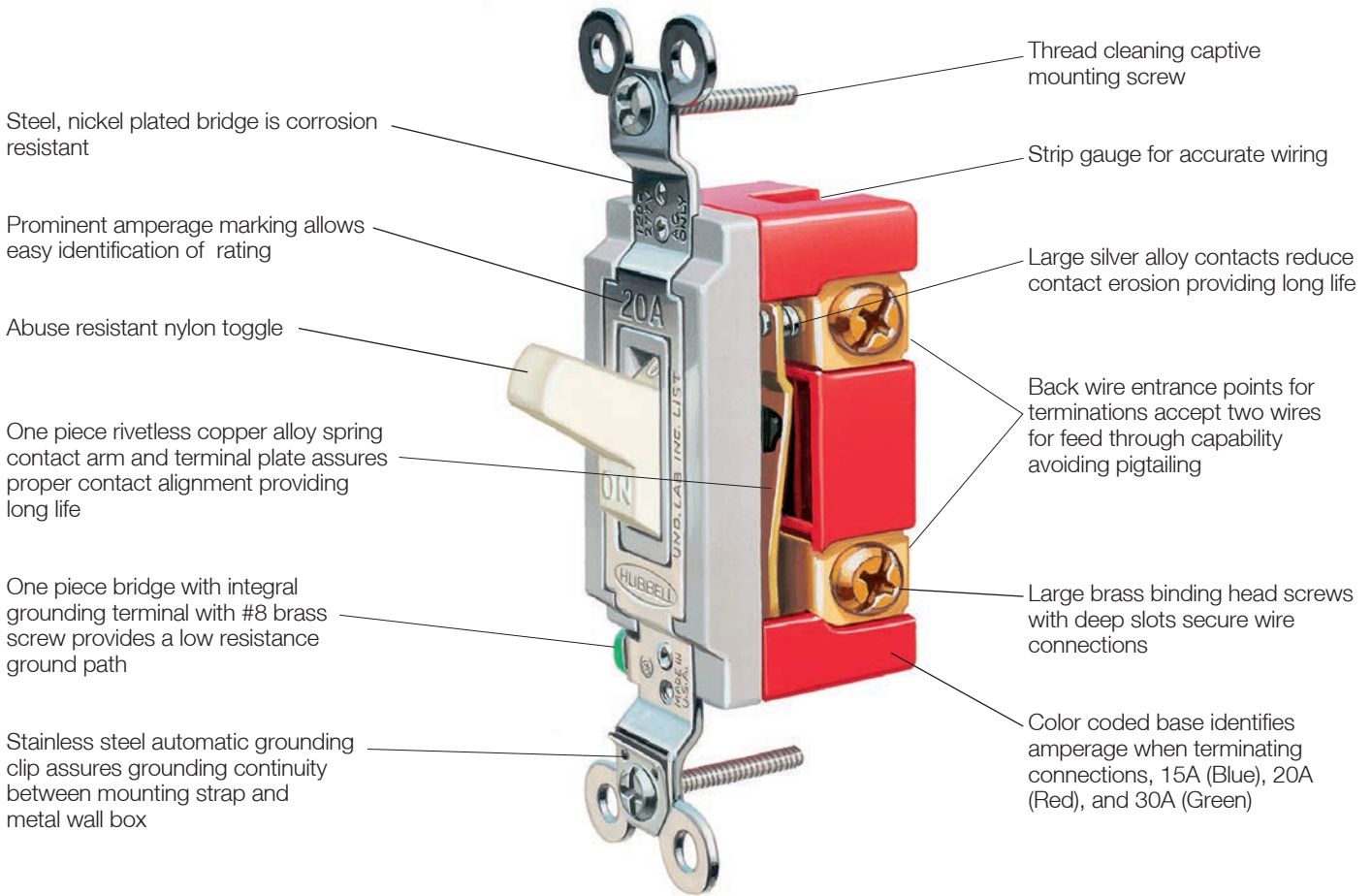

Steel, nickel plated bridge is corrosion resistant

Prominent amperage marking allows easy identification of rating

Abuse resistant nylon toggle

One piece rivetless copper alloy spring contact arm and terminal plate assures proper contact alignment providing long life

One piece bridge with integral grounding terminal with #8 brass screw provides a low resistance ground path

Stainless steel automatic grounding clip assures grounding continuity between mounting strap and metal wall box

Thread cleaning captive mounting screw

Strip gauge for accurate wiring

Large silver alloy contacts reduce contact erosion providing long life

Back wire entrance points for terminations accept two wires for feed through capability avoiding pigtailing

Large brass binding head screws with deep slots secure wire connections

Color coded base identifies amperage when terminating connections, 15A (Blue), 20A (Red), and 30A (Green)

HBL1221I



One piece rivetless copper alloy spring contact arm and terminal plate assures proper contact alignment reducing heat rise. Large silver alloy contacts reduce contact erosion and prevent welding, providing long life.



Elastomer rocker assures quiet operation and precise timing. Permanently lubricated assembly provides long life and trouble free operation.



Heavy duty nylon toggle resists abuse and chemical attack making it suitable for use in the toughest environments.

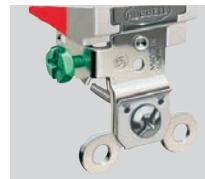

One piece integral grounding terminal with #8 brass screw allows compliance to NEC®. Stainless steel automatic self-grounding clip assures grounding continuity between mounting strap and metal wall box. Steel nickel plated mounting strap provides a corrosion resistant finish.

NEC® is a registered trademark of the National Fire Protection Association (NFPA).

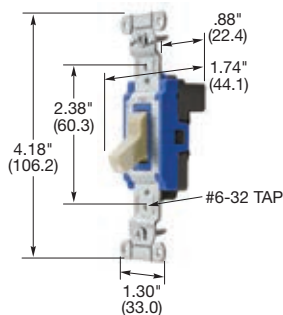

SNAP1201INA

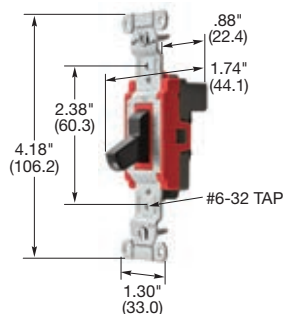

SNAP1221BKNA

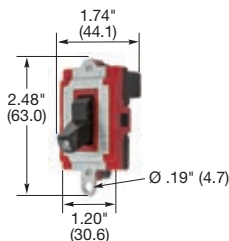

SNAPSWJUMP



SNAPSP1NA



SNAP3W1NA



SNAPSP1NA

SNAPConnect® Specification Grade Toggle Series, Assembled in USA
15A, 120-277V AC

Description	Toggle Color	Single Pole	Double Pole	Three Way	Four Way
SNAPConnect® Toggle.	Black	SNAP1201BKNA	—	SNAP1203BKNA	—
	Brown	SNAP1201BRNA	—	SNAP1203BRNA	—
	Gray	SNAP1201GYNA	—	SNAP1203GYNA	—
	Ivory	SNAP1201INA	—	SNAP1203INA	—
	Lt. Almond	SNAP1201LANA	—	SNAP1203LANA	—
	Red	SNAP1201RNA	—	SNAP1203RNA	—
	White	SNAP1201WNA	—	SNAP1203WNA	—

20A, 120-277V AC

Description	Toggle Color	Single Pole	Double Pole	Three Way	Four Way
SNAPConnect® Toggle.	Black	SNAP1221BKNA	—	SNAP1223BKNA	—
	Brown	SNAP1221BRNA	—	SNAP1223BRNA	—
	Gray	SNAP1221GYNA	—	SNAP1223GYNA	—
	Ivory	SNAP1221INA	—	SNAP1223INA	—
	Lt. Almond	SNAP1221LANA	—	SNAP1223LANA	—
	Red	SNAP1221RNA	—	SNAP1223RNA	—
	White	SNAP1221WNA	—	SNAP1223WNA	—

Illuminated, Light On with Load Off
15A, 120-277V AC

Description	Toggle Color	Single Pole	Double Pole	Three Way	Four Way
Illuminated, Light On with Load Off, Toggle, Blue LED.	Black	SNAP1201ILBKNA	—	SNAP1203ILBKNA	—
	Ivory	SNAP1201ILINA	—	SNAP1203ILINA	—
	Red	SNAP1201ILRNA	—	SNAP1203ILRNA	—
	White	SNAP1201ILWNA	—	SNAP1203ILWNA	—

20A, 120-277V AC

Description	Toggle Color	Single Pole	Double Pole	Three Way	Four Way
Illuminated, Light On with Load Off, Toggle, Blue LED.	Black	SNAP1221ILBKNA	—	SNAP1223ILBKNA	—
	Ivory	SNAP1221ILINA	—	SNAP1223ILINA	—
	Red	SNAP1221ILRNA	—	SNAP1223ILRNA	—
	White	SNAP1221ILWNA	—	SNAP1223ILWNA	—

Pilot, Light On with Load On
15A, 120-277V AC

Description	Toggle Color	Single Pole	Double Pole	Three Way	Four Way
Pilot, Light On with Load On, Toggle, Red LED.	Black	SNAP1201PLBKNA	—	—	—
	Ivory	SNAP1201PLINA	—	—	—
	Red	SNAP1201PLRNA	—	—	—
	White	SNAP1201PLWNA	—	—	—

20A, 120-277V AC

Description	Toggle Color	Single Pole	Double Pole	Three Way	Four Way
Pilot, Light On with Load On, Toggle, Red LED.	Black	SNAP1221PLBKNA	—	—	—
	Ivory	SNAP1221PLINA	—	—	—
	Red	SNAP1221PLRNA	—	—	—
	White	SNAP1221PLWNA	—	—	—

Jumper/Tester

Description	Catalog Number
Jumper/Tester for Single Pole Circuits, Black Toggle, Blue LED Indicator.	SNAPSWJUMP
Jumper/Tester for Three Way Circuits, Black Toggle, Blue LED Indicator.	SNAP3WJUMP

SNAPConnect® Switch Pigtailed Connector, Assembled in USA

Description	3 Wire Connector for Single Pole and Single Pole Illuminated	4 Wire Connector for Single Pole and Three Way with Pilot Light	4 Wire Connector for 3 Way and 3 Way Illuminated
Clear right angle terminal, 6 inch leads, solid wire.	SNAPSP1NA	SNAPSP1NA	SNAP3W1NA
Clear right angle terminal, 6 inch leads, stranded wire.	SNAPSP2NA	SNAPSP2NA	SNAP3W2NA

Note: See page D-13 for accessories.
See page D-15 for wallplates.
See page D-20 for technical information.

Many of these products are Assembled in USA, as indicated, and many are Buy American Compliant. Please contact Hubbell with any certification requirements.

HP Conversion Chart

	120V	208V	240V	277V AC
15A	.5HP	1.5HP	2HP	2HP
20A	1HP	2HP	2HP	2HP

Dimensions in Inches (mm)

Switches

15 and 20 Ampere, 120-277 Volts AC

SNAPConnect® Heavy Duty Style Line® Decorator Switches



SNAPConnect® Spec. Grade Style Line® Decorator Series, Assembled in USA 15A, 120-277V AC

Description	Toggle Color	Single Pole	Double Pole	Three Way	Four Way
SNAPConnect® Rocker.	Black	SNAP2101BKNA	—	SNAP2103BKNA	—
	Brown	SNAP2101BRNA	—	SNAP2103BRNA	—
	Gray	SNAP2101GYNA	—	SNAP2103GYNA	—
	Ivory	SNAP2101INA	—	SNAP2103INA	—
	Lt. Almond	SNAP2101LANA	—	SNAP2103LANA	—
	Red	SNAP2101RNA	—	SNAP2103RNA	—
	White	SNAP2101WNA	—	SNAP2103WNA	—

20A, 120-277V AC

Description	Toggle Color	Single Pole	Double Pole	Three Way	Four Way
SNAPConnect® Rocker.	Black	SNAP2121BKNA	—	SNAP2123BKNA	—
	Brown	SNAP2121BRNA	—	SNAP2123BRNA	—
	Gray	SNAP2121GYNA	—	SNAP2123GYNA	—
	Ivory	SNAP2121INA	—	SNAP2123INA	—
	Lt. Almond	SNAP2121LANA	—	SNAP2123LANA	—
	Red	SNAP2121RNA	—	SNAP2123RNA	—
	White	SNAP2121WNA	—	SNAP2123WNA	—

Illuminated, Light On with Load Off 15A, 120-277V AC

Description	Toggle Color	Single Pole	Double Pole	Three Way	Four Way
Illuminated, Light On with Load Off, Rocker, Blue LED.	Black	SNAP2101ILBKNA	—	SNAP2103ILBKNA	—
	Ivory	SNAP2101ILINA	—	SNAP2103ILINA	—
	Red	SNAP2101ILRNA	—	SNAP2103ILRNA	—
	White	SNAP2101ILWNA	—	SNAP2103ILWNA	—

20A, 120-277V AC

Description	Toggle Color	Single Pole	Double Pole	Three Way	Four Way
Illuminated, Light On with Load Off, Rocker, Blue LED.	Black	SNAP2121ILBKNA	—	SNAP2123ILBKNA	—
	Ivory	SNAP2121ILINA	—	SNAP2123ILINA	—
	Red	SNAP2121ILRNA	—	SNAP2123ILRNA	—
	White	SNAP2121ILWNA	—	SNAP2123ILWNA	—

Pilot, Light On with Load On 15A, 120-277V AC

Description	Toggle Color	Single Pole	Double Pole	Three Way	Four Way
Pilot, Light On with Load On, Rocker, Red LED.	Black	SNAP2101PLBKNA	—	—	—
	Ivory	SNAP2101PLINA	—	—	—
	Red	SNAP2101PLRNA	—	—	—
	White	SNAP2101PLWNA	—	—	—

20A, 120-277V AC

Description	Toggle Color	Single Pole	Double Pole	Three Way	Four Way
Pilot, Light On with Load On, Rocker, Red LED.	Black	SNAP2121PLBKNA	—	—	—
	Ivory	SNAP2121PLINA	—	—	—
	Red	SNAP2121PLRNA	—	—	—
	White	SNAP2121PLWNA	—	—	—

Jumper/Tester

Description	Catalog Number
Jumper/Tester for Single Pole Circuits, Black Toggle, Blue LED Indicator.	SNAPSWJUMP
Jumper/Tester for Three Way Circuits, Black Toggle, Blue LED Indicator.	SNAP3WJUMP

SNAPConnect® Switch Pigtailed Connector, Assembled in USA

Description	3 Wire Connector for Single Pole and Single Pole Illuminated	4 Wire Connector for Single Pole with Pilot Light	4 Wire Connector for 3 Way and 3 Way Illuminated
Clear right angle terminal, 6 inch leads, solid wire.	SNAPSP1NA	SNAPSP1NA	SNAP3W1NA
Clear right angle terminal, 6 inch leads, stranded wire.	SNAPSP2NA	SNAPSP2NA	SNAP3W2NA

Note: See page D-13 for accessories.

See page D-15 for wallplates.

See page D-20 for technical information.

Many of these products are Assembled in USA, as indicated, and many are Buy American Compliant. Please contact Hubbell with any certification requirements.

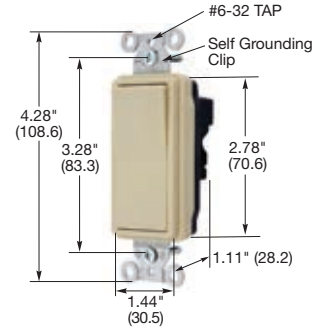

SNAP2101INA

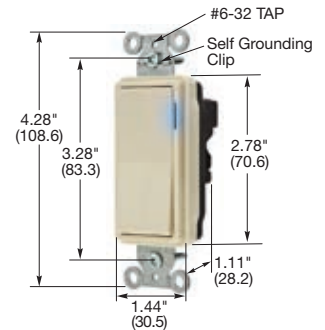

SNAP2121ILINA

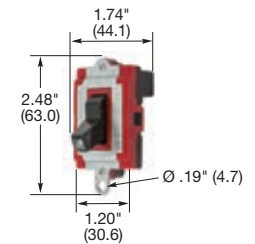

SNAPSWJUMP

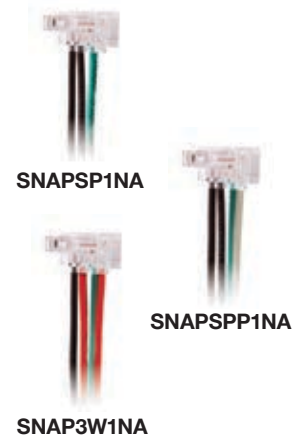

HP Conversion Chart

	120V	208V	240V	277V AC
15A	.5HP	1.5HP	2HP	2HP
20A	1HP	2HP	2HP	2HP

Dimensions in Inches (mm)

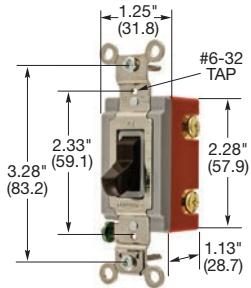

HBL1221

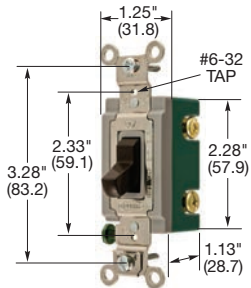

HBL3031

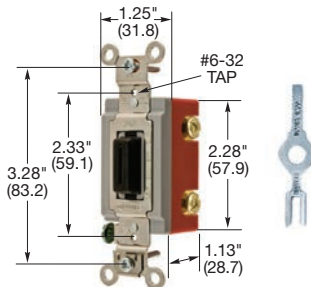

HBL1221L and Key

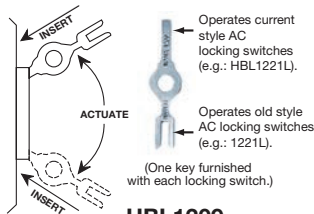

HBL1209

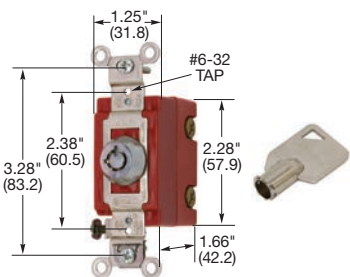

HBL1222RKL and Key

Dimensions in Inches (mm)

HBL Extra Heavy Duty Industrial Series, Back and Side Wired
15A, 120-277V AC

Description	Toggle Color	Single Pole	Double Pole	Three Way	Four Way
Toggle, back and side wired.	Black	HBL1201BK	—	HBL1203BK	HBL1204BK
	Brown	HBL1201	HBL1202	HBL1203	HBL1204
	Gray	HBL1201GY	—	HBL1203GY	HBL1204GY
	Ivory	HBL1201I	HBL1202I	HBL1203I	HBL1204I
	Light Almond	HBL1201LA	—	—	—
	Red	HBL1201R	—	—	—
	White	HBL1201W	—	HBL1203W	HBL1204W

20A, 120-277V AC

Description	Toggle Color	Single Pole	Double Pole	Three Way	Four Way
Toggle, back and side wired.	Black	HBL1221BK	HBL1222BK	HBL1223BK	HBL1224BK
	Brown	HBL1221	HBL1222	HBL1223	HBL1224
	Gray	HBL1221GY	HBL1222GY	HBL1223GY	HBL1224GY
	Ivory	HBL1221I	HBL1222I	HBL1223I	HBL1224I
	Light Almond	HBL1221LA	HBL1222LA	HBL1223LA	HBL1224LA
	Office White	HBL1221OW	HBL1222OW	HBL1223OW	HBL1224OW
	Red	HBL1221R	HBL1222R	HBL1223R	HBL1224R
	White	HBL1221W	HBL1222W	HBL1223W	HBL1224W

30A, 120-277V AC

Description	Key Guide Color	Single Pole	Double Pole	Three Way	Four Way
Nylon toggle.	Brown	HBL3031	HBL3032	HBL3033	—
	Ivory	HBL3031I	HBL3032I	HBL3033I	—
	White	—	HBL3032W	—	—

HBL Extra Heavy Duty Industrial Locking Series, Back and Side Wired
15A, 120-277V AC

Description	Key Guide Color	Single Pole	Double Pole	Three Way	Four Way
Key Guide, back and side wired.	Black	HBL1201L	HBL1202L	HBL1203L	HBL1204L
	Gray	HBL1201LG	HBL1202LG	HBL1203LG	HBL1204LG
	Ivory	HBL1201LI	HBL1202LI	HBL1203LI	HBL1204LI
	White	HBL1201LW	HBL1202LW	HBL1203LW	HBL1204LW
Key for Locking switch.		HBL1209*			

20A, 120-277V AC

Description	Key Guide Color	Single Pole	Double Pole	Three Way	Four Way
Key Guide, back and side wired.	Black	HBL1221L	HBL1222L	HBL1223L	HBL1224L
	Gray	HBL1221LG	HBL1222LG	HBL1223LG	HBL1224LG
	Ivory	HBL1221LI	HBL1222LI	HBL1223LI	HBL1224LI
	White	HBL1221LW	HBL1222LW	HBL1223LW	HBL1224LW
Key for Locking switch.		HBL1209*			

HBL Extra Heavy Duty Industrial AC Barrel Key Locking Switch†, Back and Side Wired
20A, 120-277V AC

Description	Key Guide Color	Single Pole	Double Pole	Three Way	Four Way
Chrome operator, back and side wired.	Chrome	HBL1221RKL**	HBL1222RKL**	HBL1223RKL**	HBL1224RKL**
Replacement Barrel Key.		HBL1209RKL*			

Note: Keys are supplied with each locking switch. For extra keys order HBL1209.

*Not UL Listed, CSA Certified.

**Not Fed. Spec.

† See Wallplate section, page N-17 for wallplates.

See page D-13 for accessories.

See page D-15 for wallplates.

See page D-20 for technical information.

HP Conversion Chart

	120V	208V	240V	277V AC
15A	.5HP	1.5HP	2HP	2HP
20A	1HP	2HP	2HP	2HP
30A	2HP	2HP	2HP	2HP

Switches

15, 20 and 30 Ampere, 120-277 and 347 Volts AC

HBL® Extra Heavy Duty Industrial Series



HBL Extra Heavy Duty Industrial Series, Illuminated Toggle Switches, Light On with Load Off, Back and Side Wired

Description	Toggle Color	Rating	Single Pole	Double Pole	Three Way
Nylon toggle, back and side wired.	Ivory	15A 120-277V AC	HBL1201IL	—	HBL1203IL
	Ivory	20A 120-277V AC	HBL1221IL	—	HBL1223IL
	Clear		HBL1221ILC	—	HBL1223ILC
	Red		HBL1221ILR	—	—

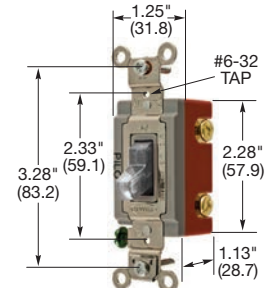

HBL1221ILC

HBL Extra Heavy Duty Industrial Series, Pilot Light Switches, Light On with Load On, Back and Side Wired

Description	Toggle Color	Rating	Single Pole	Double Pole	Three Way
Nylon toggle, back and side wired.	Red	15A 120-277V AC	HBL1201PL	—	HBL1203PL
	Red	20A 120-277V AC	HBL1221PL	HBL1222PL	HBL1223PL
	Clear		HBL1221PLC	—	HBL1223PLC
	Green		HBL1221PLG	—	—
	Red	30A 120-277V AC	HBL3031PL	HBL3032PL	—

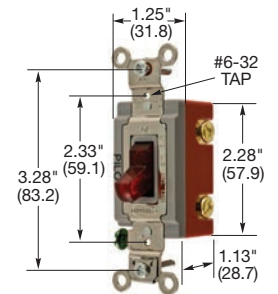

HBL1221PL

Momentary Contact, Specification Grade, Three Position, Two Circuit, Center Off, Back and Side Wired

Description	Toggle Color	15A, 120-277V AC	20A, 120-277V AC
Nylon toggle, back and side wired.	Brown	HBL1556	HBL1557
	Gray	HBL1556GY	HBL1557GY
	Ivory	HBL1556I	HBL1557I
	Red	HBL1556R	—
	White	HBL1556W	HBL1557W
Key guide, back and side wired.	Black	HBL1556L	HBL1557L
	Gray	HBL1556LG	HBL1557LG
	Ivory	HBL1556LI	HBL1557LI
	White	HBL1556LW	HBL1557LW
Key for Locking switch.	HBL1209*		

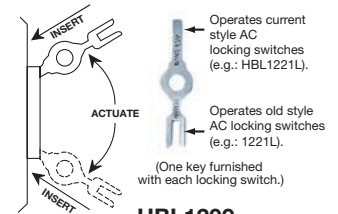

HBL1209

Maintained Contact, Specification Grade, Three Position, Two Circuit, Center Off, Single Pole, Double Throw

Description	Toggle Color	15A 120-277V AC	20A 120-277V AC	30A 120-277V AC
Nylon toggle, back and side wired.	Brown	HBL1381	HBL1385	—
	Ivory	HBL1381I	HBL1385I	—
	White	—	HBL1385W	—

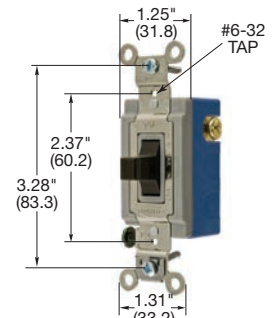

HBL1381

Three Position, Two Circuit, Center Off, Double Pole, Double Throw

Description	Toggle Color	15A 120-277V AC	20A 120-277V AC	30A 120-277V AC
Nylon toggle, back and side wired.	Brown	HBL1382	HBL1386	HBL1388
	Ivory	HBL1382I	HBL1386I	HBL1388I
Locking.		—	HBL1386L	—
Key for Locking switch.		—	HBL1209*	—

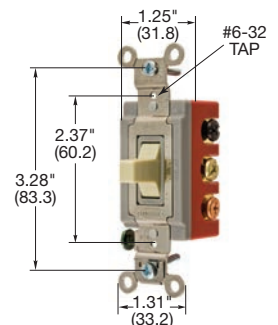

HBL1386I

Note: Keys are supplied with each locking switch. For extra keys order HBL1209.

*Not UL Listed, CSA Certified.

See page D-13 for accessories.

See page D-15 for wallplates.

See page D-20 for technical information.

HP Conversion Chart

	120V	208V	240V	277V AC
15A	.5HP	1.5HP	2HP	2HP
20A	1HP	2HP	2HP	2HP
30A	2HP	2HP	2HP	2HP

Dimensions in Inches (mm)

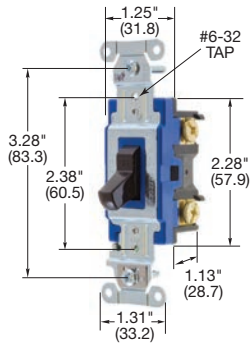

1201BK

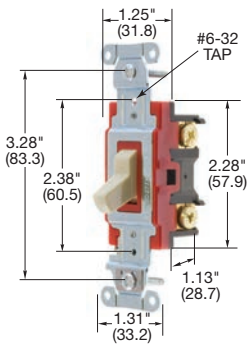

1221I

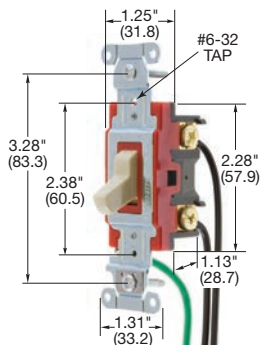

1221PWI

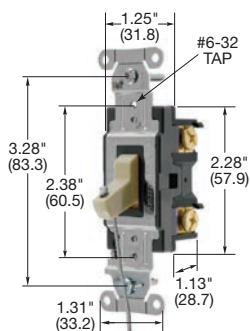

HBL1221IHCS

Dimensions in Inches (mm)

Hubbell-PRO Heavy Duty Industrial Series, 15A, 120-277V AC

Description	Toggle Color	Single Pole	Double Pole	Three Way	Four Way
Toggle, back and side wired.	Almond	1201AL	—	1203AL	—
	Black	1201BK	—	1203BK	—
	Brown	1201B	—	1203B	—
	Gray	1201GY	—	1203GY	—
	Ivory	1201I	—	1203I	—
	Light Almond	1201LA	—	1203LA	—
	White	1201W	—	1203W	—

Hubbell-PRO Heavy Duty Industrial Series, 20A, 120-277V AC

Description	Toggle Color	Single Pole	Double Pole	Three Way	Four Way
Toggle, back and side wired.	Almond	1221AL	1222AL	1223AL	1224AL
	Black	1221BK	1222BK	1223BK	1224BK
	Brown	1221B	1222B	1223B	1224B
	Gray	1221GY	1222GY	1223GY	1224GY
	Ivory	1221I	1222I	1223I	1224I
	Light Almond	1221LA	1222LA	1223LA	1224LA
	Red	1221R	1222R	1223R	1224R
	White	1221W	1222W	1223W	1224W

Hubbell-PRO Pre-Wired/Leaded Heavy Duty Industrial Series 20A, 120-277V AC - 8" #12 AWG THHN

Description	Toggle Color	Single Pole	Double Pole	Three Way	Four Way
Toggle, Pre-wired leads.	Almond	1221PWAL	1222PWAL	1223PWAL	1224PWAL
	Black	1221PWBK	1222PWBK	1223PWBK	1224PWBK
	Brown	1221PWB	1222PWB	1223PWB	1224PWB
	Gray	1221PWGY	1222PWGY	1223PWGY	1224PWGY
	Ivory	1221PWI	1222PWI	1223PWI	1224PWI
	Light Almond	1221PWLA	1222PWLA	1223PWLA	1224PWLA
	Red	1221PWR	1222PWR	1223PWR	1224PWR
	White	1221PWW	1222PWW	1223PWW	1224PWW

Hubbell-PRO Hospital Call Switch, with Lanyard 20A, 120-277V AC

Description	Toggle Color	Single Pole	Double Pole	Three Way	Four Way
Toggle, back and side wired.	Gray	HBL1221GHCS	—	—	—
	Ivory	HBL1221IHCS	—	—	—
	White	HBL1221WHCS	—	—	—

Note: See page D-13 for accessories.
See page D-15 for wallplates.
See page D-20 for technical information.

HP Conversion Chart

	120V	208V	240V	277V AC
15A	.5HP	1.5HP	2HP	2HP
20A	1HP	2HP	2HP	2HP



**Pre-Wired/Leaded Toggle Series Specification Grade
15A, 120-277V AC - 8" #12 AWG THHN**



Description	Toggle Color	Single Pole	Double Pole	Three Way	Four Way
Toggle, Nylon, Pre-wired leads.	Almond	CSL115AL	CSL215AL	CSL315AL	CSL415AL
	Black	CSL115BK	CSL215BK	CSL315BK	CSL415BK
	Brown	CSL115	CSL215	CSL315	CSL415
	Gray	CSL115GY	CSL215GY	CSL315GY	CSL415GY
	Ivory	CSL115I	CSL215I	CSL315I	CSL415I
	Light Almond	CSL115LA	CSL215LA	CSL315LA	CSL415LA
	Office White	CSL115OW	CSL215OW	CSL315OW	CSL415OW
	White	CSL115W	CSL215W	CSL315W	CSL415W

20A, 120-277V AC

Description	Toggle Color	Single Pole	Double Pole	Three Way	Four Way
Toggle, Nylon, Pre-wired leads.	Almond	CSL120AL	CSL220AL	CSL320AL	CSL420AL
	Black	CSL120BK	CSL220BK	CSL320BK	CSL420BK
	Brown	CSL120	CSL220	CSL320	CSL420
	Gray	CSL120GY	CSL220GY	CSL320GY	CSL420GY
	Ivory	CSL120I	CSL220I	CSL320I	CSL420I
	Light Almond	CSL120LA	CSL220LA	CSL320LA	CSL420LA
	Office White	CSL120OW	CSL220OW	CSL320OW	CSL420OW
	Red	CSL120R	CSL220R	CSL320R	CSL420R
White	CSL120W	CSL220W	CSL320W	CSL420W	

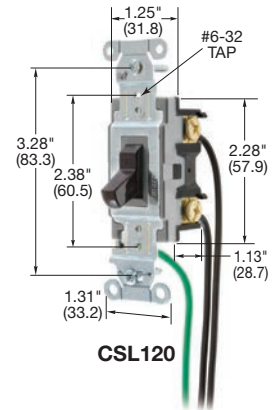

**Pre-Wired/Leaded Decorator Series Specification Grade
15A, 120-277V AC - 8" #12 AWG THHN**



Description	Rocker Color	Single Pole	Double Pole	Three Way	Four Way
Rocker, Polycarbonate, Pre-wired leads.	Almond	DSL115AL	—	DSL315AL	—
	Black	DSL115BK	—	DSL315BK	—
	Brown	DSL115	—	DSL315	—
	Gray	DSL115GY	—	DSL315GY	—
	Ivory	DSL115I	—	DSL315I	—
	Light Almond	DSL115LA	—	DSL315LA	—
	Office White	DSL115OW	—	DSL315OW	—
	White	DSL115W	—	DSL315W	—

20A, 120-277V AC

Description	Rocker Color	Single Pole	Double Pole	Three Way	Four Way
Rocker, Polycarbonate, Pre-wired leads.	Almond	DSL120AL	DSL220AL	DSL320AL	DSL420AL
	Black	DSL120BK	DSL220BK	DSL320BK	DSL420BK
	Brown	DSL120	DSL220	DSL320	DSL420
	Gray	DSL120GY	DSL220GY	DSL320GY	DSL420GY
	Ivory	DSL120I	DSL220I	DSL320I	DSL420I
	Light Almond	DSL120LA	DSL220LA	DSL320LA	DSL420LA
	Office White	DSL120OW	DSL220OW	DSL320OW	DSL420OW
	White	DSL120W	DSL220W	DSL320W	DSL420W

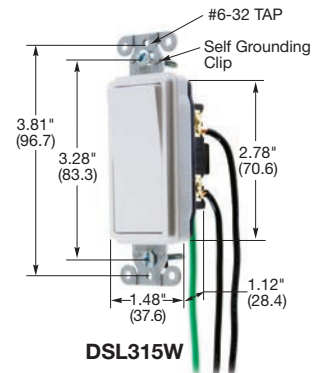

**Illuminated, Light On with Load Off
20A, 120-277V AC**

Description	Rocker Color	Single Pole	Double Pole	Three Way	Four Way
Rocker, Polycarbonate, Pre-wired leads, Blue LED.	Ivory	DSL120IL	—	DSL320IL	—
	White	DSL120ILW	—	DSL320ILW	—

**Pilot, Light On with Load On
20A, 120-277V AC**

Description	Rocker Color	Single Pole	Double Pole	Three Way	Four Way
Rocker, Polycarbonate, Pre-wired leads, Red LED.	Red	DSL120PL	—	—	—

Note: See page D-13 for accessories.
See page D-15 for wallplates.
See page D-20 for technical information.

HP Conversion Chart

	120V	208V	240V	277V AC
15A	.5HP	1.5HP	2HP	2HP
20A	1HP	2HP	2HP	2HP

Dimensions in Inches (mm)

**Specification Grade Commercial Series,
15A, 120-277V AC**

Description	Toggle Color	Single Pole	Double Pole	Three Way	Four Way
Toggle, back and side wired.	Almond	CSB115AL	CSB215AL	CSB315AL	CSB415AL
	Black	CSB115BK	CSB215BK	CSB315BK	CSB415BK
	Brown	CSB115	CSB215	CSB315	CSB415
	Gray	CSB115GY	CSB215GY	CSB315GY	CSB415GY
	Ivory	CSB115I	CSB215I	CSB315I	CSB415I
	Light Almond	CSB115LA	CSB215LA	CSB315LA	CSB415LA
	White	CSB115W	CSB215W	CSB315W	CSB415W

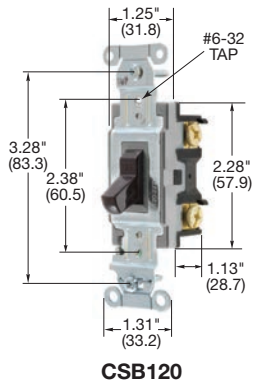
**Specification Grade Commercial Series,
20A, 120-277V AC**

Description	Toggle Color	Single Pole	Double Pole	Three Way	Four Way
Toggle, back and side wired.	Almond	CSB120AL	CSB220AL	CSB320AL	CSB420AL
	Black	CSB120BK	CSB220BK	CSB320BK	CSB420BK
	Brown	CSB120	CSB220	CSB320	CSB420
	Gray	CSB120GY	CSB220GY	CSB320GY	CSB420GY
	Ivory	CSB120I	CSB220I	CSB320I	CSB420I
	Light Almond	CSB120LA	CSB220LA	CSB320LA	CSB420LA
	Red	CSB120R	CSB220R	CSB320R	CSB420R
	White	CSB120W	CSB220W	CSB320W	CSB420W

**Specification Grade Commercial Series,
15A, 120-277V AC**

Description	Toggle Color	Single Pole	Double Pole	Three Way	Four Way
Toggle, side wired only.	Almond	CS115AL	—	CS315AL	—
	Black	CS115BK	—	CS315BK	—
	Brown	CS115	—	CS315	—
	Gray	CS115GY	—	CS315GY	—
	Ivory	CS115I	—	CS315I	—
	Light Almond	CS115LA	—	CS315LA	—
	White	CS115W	—	CS315W	—

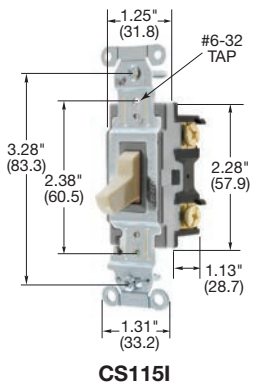
**Specification Grade Commercial Series,
20A, 120-277V AC**

Description	Toggle Color	Single Pole	Double Pole	Three Way	Four Way
Toggle, side wired only.	Almond	CS120AL	—	CS320AL	—
	Black	CS120BK	—	CS320BK	—
	Brown	CS120	—	CS320	—
	Gray	CS120GY	—	CS320GY	—
	Ivory	CS120I	—	CS320I	—
	Light Almond	CS120LA	—	CS320LA	—
	White	CS120W	—	CS320W	—

Note: See page D-9 for pre-wired/leaded devices.
See page D-13 for accessories.
See page D-15 for wallplates.
See page D-20 for technical information.

HP Conversion Chart

	120V	208V	240V	277V AC
15A	.5HP	1.5HP	2HP	2HP
20A	1HP	2HP	2HP	2HP

Dimensions in Inches (mm)



Style Line® Decorator Series Specification Grade, 15A, 120-277V AC

Description	Rocker Color	Single Pole	Double Pole	Three Way	Four Way
Rocker, back and side wired.	Almond	DS115AL	—	DS315AL	—
	Black	DS115BK	—	DS315BK	—
	Brown	DS115	—	DS315	—
	Gray	DS115GY	—	DS315GY	—
	Ivory	DS115I	—	DS315I	—
	Light Almond	DS115LA	—	DS315LA	—
	Office White	DS115OW	—	DS315OW	—
White	DS115W	—	DS315W	—	

Style Line® Decorator Series Specification Grade, 20A, 120-277V AC

Description	Rocker Color	Single Pole	Double Pole	Three Way	Four Way
Rocker, back and side wired.	Almond	DS120AL	DS220AL	DS320AL	DS420AL
	Black	DS120BK	DS220BK	DS320BK	DS420BK
	Brown	DS120	DS220B	DS320	DS420
	Gray	DS120GY	DS220GY	DS320GY	DS420GY
	Ivory	DS120I	DS220I	DS320I	DS420I
	Light Almond	DS120LA	DS220LA	DS320LA	DS420LA
	Office White	DS120OW	DS220OW	DS320OW	DS420OW
	Red	DS120R	DS220R	DS320R	DS420R
	White	DS120W	DS220W	DS320W	DS420W

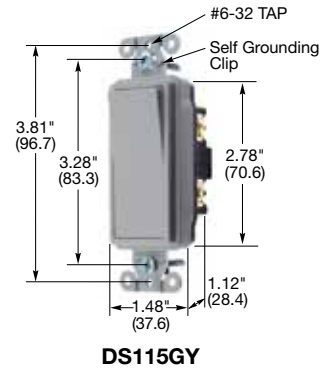

Style Line® Decorator Series Specification Grade, Illuminated, Light On with Load Off 20A, 120-277V AC

Description	Rocker Color	Single Pole	Double Pole	Three Way	Four Way
Rocker, with Blue LED, back and side wired.	Black	DS120ILBK	—	DS320ILBK	—
	Ivory	DS120IL	—	DS320IL	—
	White	DS120ILW	—	DS320ILW	—

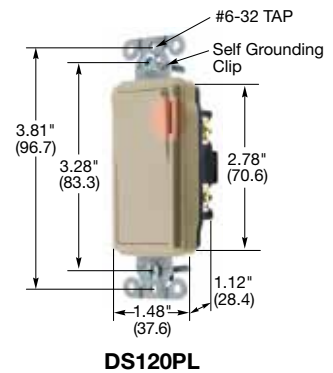

Style Line® Decorator Series Specification Grade, Pilot, Light On with Load On 20A, 120-277V AC

Description	Rocker Color	Single Pole	Double Pole	Three Way	Four Way
Rocker, with Red LED, back and side wired.	Black	DS120PLBK	—	—	—
	Ivory	DS120PL	—	—	—
	White	DS120PLW	—	—	—

Note: See page D-9 for pre-wired/leaded devices.

See page D-13 for accessories.

See page D-15 for wallplates.

See page D-20 for technical information.

HP Conversion Chart

	120V	208V	240V	277V AC
15A	.5HP	1.5HP	2HP	2HP
20A	1HP	2HP	2HP	2HP

Dimensions in Inches (mm)

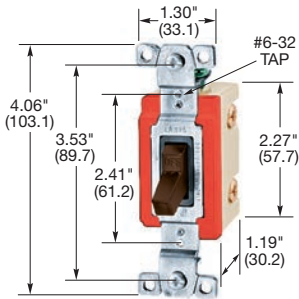

HBL18221CN

**HBL® Extra Heavy Duty Industrial Series
15A, 347V AC**



Description	Toggle Color	Single Pole	Double Pole	Three Way	Four Way
Nylon toggle, back and side wired.	Brown	HBL18201CN	—	HBL18203CN	—
	Ivory	HBL18201ICN	—	HBL18203ICN	HBL18204ICN
Locking.		HBL18201LCN	—	HBL18203LCN	—
Key for Locking switch.		HBL1209*			

**HBL® Extra Heavy Duty Industrial Series
20A, 347V AC**



Description	Toggle Color	Single Pole	Double Pole	Three Way	Four Way
Nylon toggle, back and side wired.	Brown	HBL18221CN	—	HBL18223CN	—
	Ivory	HBL18221ICN	—	HBL18223ICN	HBL18224ICN

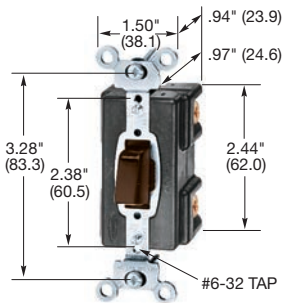

HBL1281

**PresSwitch® Specification Grade Push Button, Standard Type
20A, 120-277V AC**



Description	Toggle Color	Single Pole	Double Pole	Three Way	Four Way
Nylon actuator, side wired only.	Brown	HBL1281	HBL1282	HBL1283*	HBL1284*
	Ivory	HBL1281I	HBL1282I	HBL1283I*	HBL1284I*

**Momentary Type®
20A, 120-277V AC**

Description	Toggle Color	Single Pole	Double Pole	Three Way	Four Way
Circuit normally closed, side wired only.	Brown	HBL1281MC*	—	—	—
Circuit normally open, side wired only.	Brown	HBL1281MO*	—	—	—

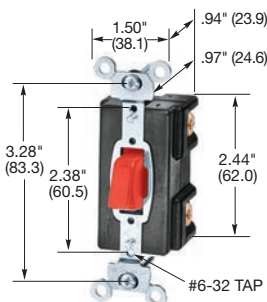

HBL1297

**Illuminated and Pilot Light PresSwitch®,
120V AC Lighted Actuator, Light On with Load Off•**



Description	Toggle Color	Single Pole	Double Pole	Three Way	Four Way
15A, nylon actuator.	Ivory	—	—	—	HBL1259I*
20A, nylon actuator.	Ivory	HBL1287I	—	HBL1288I*	—

**Pilot Light Actuator, Light On with Load On
20A, 120V AC**



Description	Toggle Color	Single Pole	Double Pole	Three Way	Four Way
Nylon actuator.	Red	HBL1297	—	HBL1298*	—

Note: Keys are supplied with each locking switch. For extra keys order HBL1209.

*Not UL Listed, CSA Certified.

•Not HP rated.

See page D-13 for accessories.

See page D-15 for wallplates.

See page D-20 for technical information.

HP Conversion Chart

	120V	208V	240V	277V AC
15A	.5HP	1.5HP	2HP	2HP
20A	1HP	2HP	2HP	2HP
30A	2HP	2HP	2HP	2HP

Dimensions in Inches (mm)

Switches Accessories

Pilot Light, SWITCHOUT® Lockout Device and Weatherproof Switch Plates for Toggle Switches



IP44
SUITABILITY



Pilot Light, 120-277V AC

Description	Catalog Number
Red neon pilot light, back and side wired, fits standard switch plate.	HBL1220RJ



HBL1220RJ

Brass Locking Attachment for Switches Available in Master Keying and Straight Keying Systems

Description	Catalog Number
Straight keying (all locks alike). Appropriate for most applications. Straight cylinder type lock, each HBL96061 ordered operates on the same key. All locks are keyed alike.	HBL96061*
Same as above except in dull chrome finish to match stainless steel plates.	HBL96061DCH*



HBL96061
shown with wallplate and switch (sold separately)

Description	Catalog Number
Straight keying (individual). Straight cylinder type lock, each HBL96062 ordered operates on a different key. All locks are keyed differently and individually. This type cannot be master keyed.	HBL96062*

SWITCHOUT® Lockout Device

Description	Catalog Number
Yellow, nylon toggle switch lockout device (Two devices per package).	HSLDPK2*

Weatherproof Plates



Description	Catalog Number
Clear bubble plate, silicone rubber for use with all general purpose AC toggle and PresSwitch® switches. Fits both FS/FD and standard boxes.	HBL1795
Cast aluminum lift cover plate with fiber shield. For standard toggle and PresSwitch®. Fits only FS/FD boxes.	HBL7420



HSLDPK2

Weatherproof Plates for PresSwitch®



Description	Catalog Number
Gray neoprene PresSwitch® plate. Fits FS/FD and standard boxes.	HBL1750
Same as above except yellow.	HBL17CM50
Gray neoprene PresSwitch® plate with 125V red pilot light. Fits only FS/FD boxes.	HBL1785
Same as above except yellow.	HBL17CM85

Note: *Not UL Listed or CSA Certified.

Each locking wallplate is supplied with two keys.
See section Z for additional information on safety lockout devices.
See section N for additional wallplates.

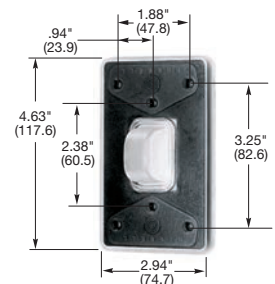

HBL1795

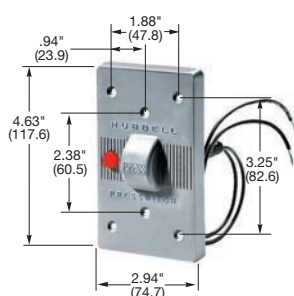

HBL1785

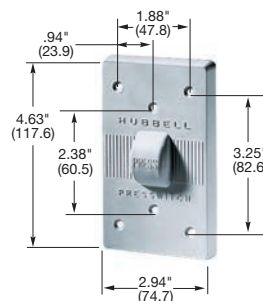

HBL1750

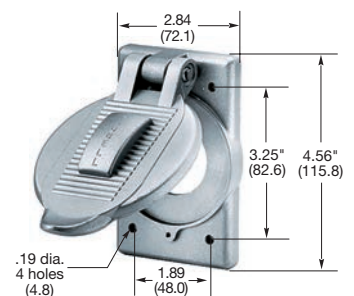

HBL7420

Dimensions in Inches (mm)



UL, CSA, and Fed. Spec. Listing Data

Catalog Number	WS896 Listed	UL Listed UL20	CSA Certified	Catalog Number	WS896 Listed	UL Listed UL20	CSA Certified
1201	Yes	Yes	Yes	HBL1224	Yes	Yes	Yes
1203	Yes	Yes	Yes	HBL1221L	Yes	Yes	Yes
1221	Yes	Yes	Yes	HBL1222L	Yes	Yes	Yes
1222	Yes	Yes	Yes	HBL1223L	Yes	Yes	Yes
1223	Yes	Yes	Yes	HBL1224L	Yes	Yes	Yes
1224	Yes	Yes	Yes	HBL1221IL	Yes	Yes	Yes
1221PW	Yes	Yes	Yes	HBL1223IL	Yes	Yes	Yes
1222PW	Yes	Yes	Yes	HBL1221PL	Yes	Yes	Yes
1223PW	Yes	Yes	Yes	HBL1222PL	Yes	Yes	Yes
1224PW	Yes	Yes	Yes	HBL1223PL	Yes	Yes	Yes
CS115	Yes	Yes	Yes	HBL1221RKL	No	Yes	Yes
CS315	Yes	Yes	Yes	HBL1222RKL	No	Yes	Yes
CS120	Yes	Yes	Yes	HBL1223RKL	No	Yes	Yes
CS320	Yes	Yes	Yes	HBL1224RKL	No	Yes	Yes
CSB115	Yes	Yes	Yes	HBL1259I	No	No	No
CSB215	Yes	Yes	Yes	HBL1281	No	Yes	Yes
CSB315	Yes	Yes	Yes	HBL1282	No	Yes	Yes
CSB415	Yes	Yes	Yes	HBL1283	No	No	No
CSB120	Yes	Yes	Yes	HBL1284	No	No	No
CSB220	Yes	Yes	Yes	HBL1287I	No	Yes	Yes
CSB320	Yes	Yes	Yes	HBL1288I	No	No	No
CSB420	Yes	Yes	Yes	HBL1281MO	No	No	No
CSL115	Yes	Yes	Yes	HBL1281MC	No	No	No
CSL215	Yes	Yes	Yes	HBL1297	No	Yes	Yes
CSL315	Yes	Yes	Yes	HBL1298	No	No	No
CSL415	Yes	Yes	Yes	HBL1381	No	Yes	Yes
CSL120	Yes	Yes	Yes	HBL1382	No	Yes	Yes
CSL220	Yes	Yes	Yes	HBL1385	No	Yes	Yes
CSL320	Yes	Yes	Yes	HBL1386	No	Yes	Yes
CSL420	Yes	Yes	Yes	HBL1386L	No	Yes	Yes
DS115	No	Yes	Yes	HBL1388	No	Yes	Yes
DS315	No	Yes	Yes	HBL1556	No	Yes	Yes
DS120	No	Yes	Yes	HBL1557	No	Yes	Yes
DS220	No	Yes	Yes	HBL1556L	No	Yes	Yes
DS320	No	Yes	Yes	HBL1557L	No	Yes	Yes
DS420	No	Yes	Yes	HBL3031	Yes	Yes	Yes
DS120IL	No	Yes	Yes	HBL3032	Yes	Yes	Yes
DS320IL	No	Yes	Yes	HBL3033	Yes	Yes	Yes
DS120PL	No	Yes	Yes	HBL3031PL	Yes	Yes	Yes
DSL115	No	Yes	Yes	HBL3031PL	Yes	Yes	Yes
DSL215	No	Yes	Yes	HBL3032PL	Yes	Yes	Yes
DSL315	No	Yes	Yes	SNAP1201	No	Yes	Yes
DSL415	No	Yes	Yes	SNAP1201IL	No	Yes	Yes
DSL120	No	Yes	Yes	SNAP1201PL	No	Yes	Yes
DSL220	No	Yes	Yes	SNAP1203	No	Yes	Yes
DSL320	No	Yes	Yes	SNAP1203IL	No	Yes	Yes
DSL420	No	Yes	Yes	SNAP1221	No	Yes	Yes
HBL1201	Yes	Yes	Yes	SNAP1221IL	No	Yes	Yes
HBL1202	Yes	Yes	Yes	SNAP1221PL	No	Yes	Yes
HBL1203	Yes	Yes	Yes	SNAP1223	No	Yes	Yes
HBL1204	Yes	Yes	Yes	SNAP1223	No	Yes	Yes
HBL1201IL	Yes	Yes	Yes	SNAP1223IL	No	Yes	Yes
HBL1203IL	Yes	Yes	Yes	SNAP2101	No	Yes	Yes
HBL1201PL	Yes	Yes	Yes	SNAP2101IL	No	Yes	Yes
HBL1203PL	Yes	Yes	Yes	SNAP2101PL	No	Yes	Yes
HBL1201L	Yes	Yes	Yes	SNAP2103	No	Yes	Yes
HBL1202L	Yes	Yes	Yes	SNAP2103IL	No	Yes	Yes
HBL1203L	Yes	Yes	Yes	SNAP2121	No	Yes	Yes
HBL1204L	Yes	Yes	Yes	SNAP2121IL	No	Yes	Yes
HBL1221	Yes	Yes	Yes	SNAP2121PL	No	Yes	Yes
HBL1222	Yes	Yes	Yes	SNAP2123	No	Yes	Yes
HBL1223	Yes	Yes	Yes	SNAP2123IL	No	Yes	Yes

Note: Catalog numbers above represent all colors and variations, per NEMA® WD-1 requirements.

NEMA® is a registered trademark of the National Electrical Manufacturers Association.



1-Gang



2-Gang



3-Gang

Standard Size, Smooth Nylon, Toggle Switch Plates

Color	Catalog Number		
Almond	NP1AL	NP2AL	NP3AL
Black	NP1BK	NP2BK	NP3BK
Brown	NP1	NP2	NP3
Gray	NP1GY	NP2GY	NP3GY
Ivory	NP1I	NP2I	NP3I
Light Almond	NP1LA	NP2LA	NP3LA
Office White	NP1OW	NP2OW	NP3OW
Red	NP1R	NP2R	—
White	NP1W	NP2W	NP3W

Standard Size, Smooth Metal, Toggle Switch Plates

Color	Catalog Number		
Aluminum	SA1	SA2	①
Brass	SB1	SB2	SBP3*
Stainless Steel, 302/304	SS1	SS2	SS3
Stainless Steel, 430	SS1L	SS2L	SS3L



1-Gang



2-Gang

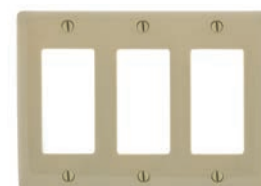

3-Gang

Standard Size, Smooth Nylon, Style Line® Switch Plates

Color	Catalog Number		
Almond	NP26AL	NP262AL	NP263AL
Black	NP26BK	NP262BK	NP263BK
Brown	NP26	NP262	NP263
Gray	NP26GY	NP262GY	NP263GY
Ivory	NP26I	NP262I	NP263I
Light Almond	NP26LA	NP262LA	NP263LA
Office White	NP26OW	NP262OW	NP263OW
Red	NP26R	NP262R	NP263R
White	NP26W	NP262W	NP263W

Standard Size, Smooth Metal, Style Line® Switch Plates

Color	Catalog Number		
Aluminum	①	①	①
Brass	SB26	SB262	①
Stainless Steel, 302/304	SS26	SS262	SS263
Stainless Steel, 430	SS26L	SS262L	—

Note: See section N for additional wallplates.

*Brass plated.

① Available as a custom metal wallplate. See section N for additional information.

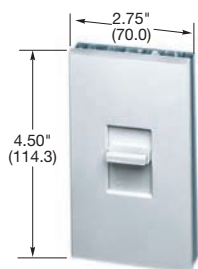

600 and 1000W Dimmer
Fits Single-Gang Wall Boxes.
AS63 and AS103

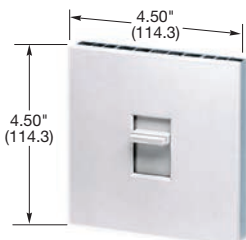

1500 and 2000W Dimmer
Fits Single-Gang Wall Boxes.
AS153 and AS203



600 and 1000W Dimmer
Fits Single-Gang Wall Boxes.
AR61 and AR101

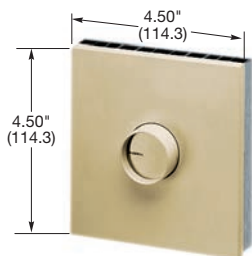

1500 and 2000W Dimmer
Fits Single-Gang Wall Boxes.
AR151 and AR201

Architectural Grade, Incandescent Preset Slide Control Dimmers

Description	Color	Rating	Catalog Number
Single pole/three way - preset.	White	600W, 120V AC, 60Hz	AS63
Single pole/three way - preset.	White	1000W, 120V AC, 60Hz	AS103
Single pole/three way - preset.	White	1500W, 120V AC, 60Hz	AS153
Single pole/three way - preset.	White	2000W, 120V AC, 60Hz	AS203

Accessories

Description	Color	Catalog Number
Small plate kit for 600W and 1000W models.	Ivory	AS1I
Includes non-metallic trimplate and slide.	White	AS1W
Large plate kit for 1500W and 2000W models.	Ivory	AS2I
Includes non-metallic trimplate and slide.	White	AS2W

*Note: The dimmers listed above can be wired for single pole or three way applications.
See page D-17 for ganging and derating.*

Architectural Grade, Incandescent Rotary Control Dimmers

Description	Color	Rating	Catalog Number
Single pole - push on/off.	Beige	600W, 120V AC, 60Hz	AR61
Three way - push on/off.	Beige		AR63
Single pole - push on/off.	Beige	1000W, 120V AC, 60Hz	AR101
Three way - push on/off.	Beige		AR103
Single pole, rotary on/off.	Beige	1500W, 120V AC, 60Hz	AR151
Single pole, rotary on/off.	Beige	2000W, 120V AC, 60Hz	AR201

Accessories

Description	Color	Catalog Number
Small plate kit for 600W and 1000W models.	Beige	AR1BE
Includes non-metallic trimplate and knob.	White	AR1W
Large plate kit for 1500W and 2000W models.	Beige	AR2BE
Includes non-metallic trimplate and knob.	White	AR2W

Note: See page D-17 for ganging and derating.



Architectural Grade Slide and Rotary Series Number of Switchboxes Required with Dimmer Side sections Intact

		Number of Small Controls (600W and 1000W)						
		0	1	2	3	4	5	6
Number of Large Controls (1500W and 2000W)	0	0	1	1+1	4	1+4	7	1+7
	1	1	3	5	6	8	9	11
	2	4	6	7	9	10	12	13
	3	6	8	10	11	13	14	16
	4	9	11	12	14	15	17	18

Number of Gangs Required

Note: When ganging an even number of small controls with no side sections removed (plus numbers in chart), use gangable switchboxes with tapped ears as shown below. Do not use plaster rings or gangbox covers. Space an additional switchbox 3/4 in. apart from the other switchbox(es). A 3/4 in. close nipple is recommended as a spacer between the switchboxes.

Example of 4-Gang Installation

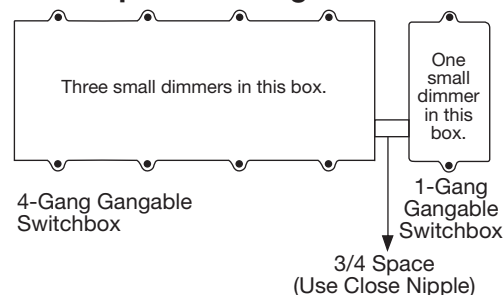

Number of Switchboxes Required with Side Sections Removed

		Number of Small Controls (600W and 1000W)						
		0	1	2	3	4	5	6
Number of Large Controls (1500W and 2000W)	0	0	1	2	3	4	5	6
	1	1	3	4	5	6	7	8
	2	3	5	6	7	8	9	10
	3	5	7	8	9	10	11	12
	4	7	9	10	11	12	13	14

Number of Gangs Required

Note: When removing side sections, remove only inner side sections. Do not remove side sections on outer ends of gang. The same installation rules apply to rotary dimmers (not shown).

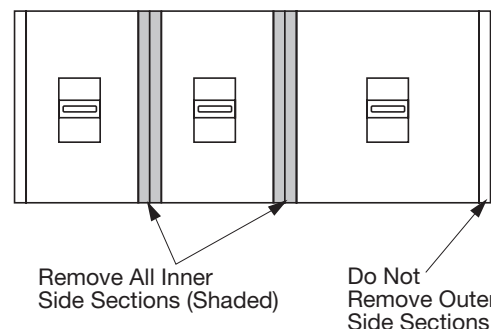

Derating Chart

No side sections removed	One side section removed	Both side sections removed
600W	600W	500W
1000W	900W	700W
1500W	1250W	1000W
2000W	1800W	1500W

Note: When ganging any combination of small and large controls, place a small control on one extreme end of the gang, and a large control at the other end of the gang. When ganging with side sections intact, use offset mounting holes. When ganging with side sections removed, use center mounting holes. Allow a 1/2 in. gap (space) between controls for ease in attaching the faceplate.

Specification Grade Slide and Rotary Series Switchboxes Required: Side sections removed

Derating Chart

1 dimmer in wall box	2 dimmers in wall box	3 or more dimmers in wall box
600W	500W	400W
1000W	800W	650W
5A fan speed	4A fan speed	3A fan speed



HBL11



HBL123SP

10A 250V AC 20A 125V AC Horsepower Rated 3/4 HP, 125-250V AC

Description	Terminal	Catalog Number
Single pole/ single throw.	Screw Spade	HBL11 HBL11SP
Single pole/ single throw momentary.	Screw Spade	HBL11M HBL11SPM
Single pole/ double throw.	Screw Spade	HBL12 HBL12SP
Single pole/ double throw 3-position center off.	Screw Spade	HBL123 HBL123SP
Single pole/ double throw 3-position center off momentary.	Screw Spade	HBL123MM HBL123SPMM

Note: All threaded stems 1/2 in.-32 thread.

10A 240V AC 15A 120V AC

Description	Terminal	Catalog Number
Single pole/ single throw.	Screw	HBL118

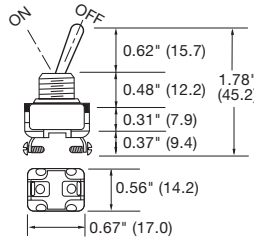

Note: 1/2 in.-32 thread.

4A 250V 8A 125V 10A 120V AC 1/3 HP 120V AC

Description	Terminal	Catalog Number
Single pole/ single throw.	#18 Std. AWG Copper Wire Leads 105° C Black.	HBL11WL

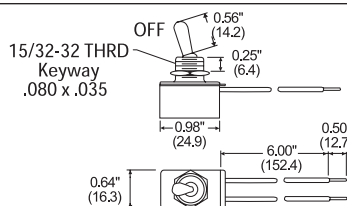

Note: 1/2 in.-32 thread, keyway .080 x .035.

Specifications

Impact Resistant Thermoplastic Body.

Fine Silver Contacts.

Knurled Nut, Hex Nut And Strap All Nickel Plated.

Keyed Brass Bushing Nickel Plated.

Brass Toggle Nickel Plated.

Choice of Terminal Design: .250 in. (6.3) Male Tab Spade Type or 6/32 Screw Type.

UL Recognized.

Dimensions in Inches (mm)

Switches

Heavy Duty Panel Mount

Panel Mount and Bat Handle Switches

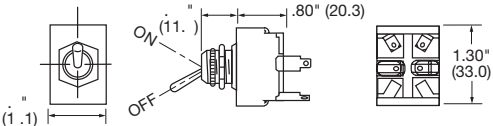
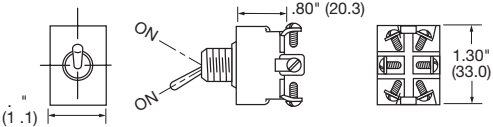
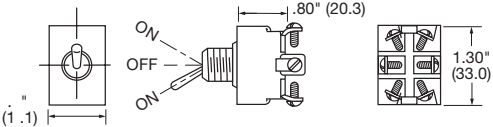
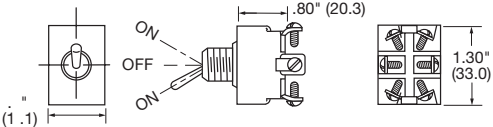

10A 250V AC 20A 125V AC Horsepower Rated 1½ HP, 125-250V AC

Description	Terminal	Catalog Number
Double pole/ single throw. 	Screw Spade	HBL21 HBL21SP
Double pole/ single throw. 	Screw Spade	HBL22 HBL22SP
Double pole/ double throw 3-position center off. 	Screw Spade	HBL223 HBL223SP
Double pole/ double throw 3-position center off momentary. 	Screw Spade	HBL223MM HBL223SPMM
Silicone rubber boot.	Screw Spade	SSB1



HBL21



HBL223



SSB1

Note: All threaded stems 1/32 in.-32 thread.
See Y-33 for information on 12V DC tapered handle switches.

4A 250V 8A 125V 10A 120V AC 1/3 HP 120V AC

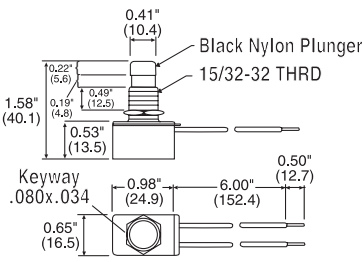
Description	Terminal	Catalog Number
Single pole/ single throw. 	#18 Std. AWG Copper Wire Leads 105° C Black.	HBL11PBWL



HBL11PBWL

Note: 1/32 in.-32 thread, keyway .080 x .035.

Dimensions in Inches (mm)



Standard Toggle Type Switches

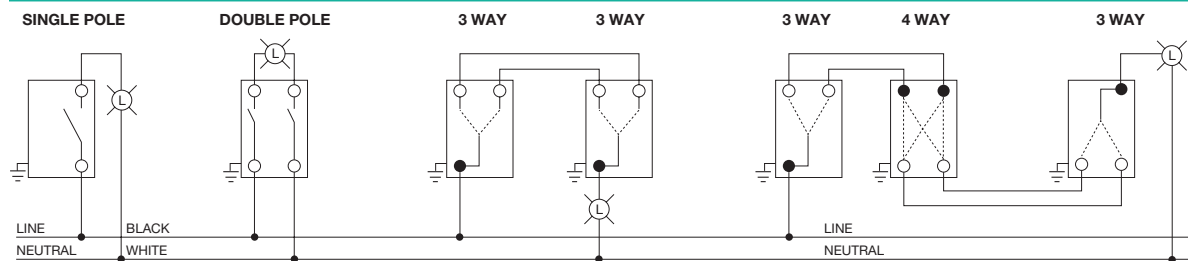

Illuminated Switches (light on with load off)

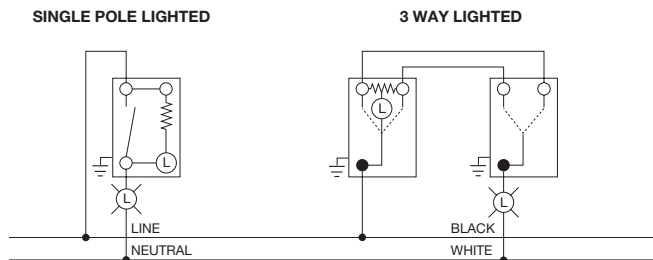

Pilot Light Switches (light on with load on)

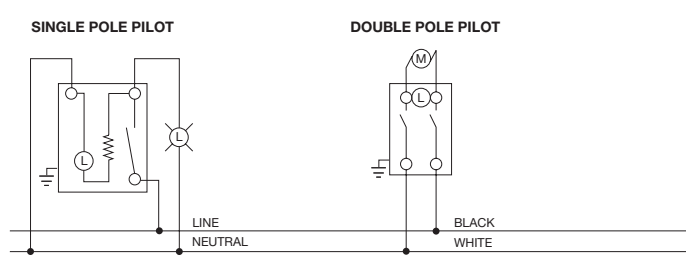

Three Way Pilot Switches

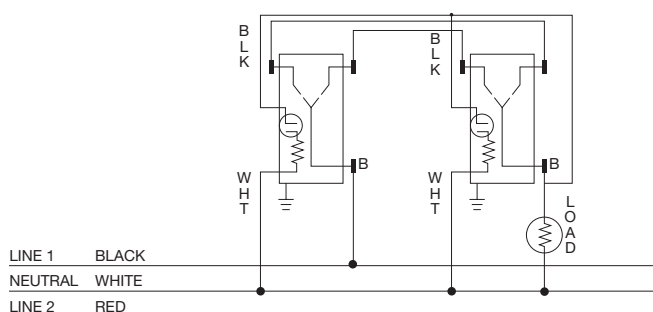

Three Position Switches, Momentary and Maintained

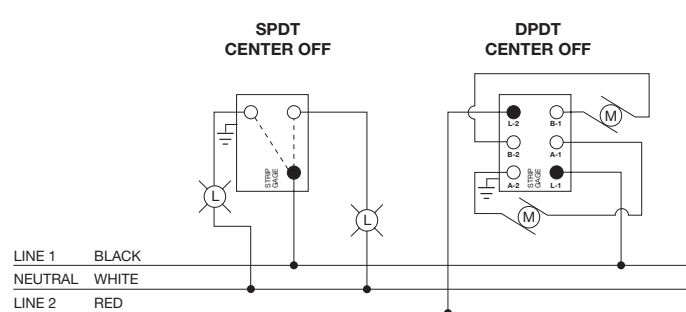

Specifications - HBL® Extra Heavy Duty Industrial Grade Switches (SP, DP, 3-Way, 4-Way)

Listings	Component	Material
UL Listed	Base	Thermoset, Color Coded by Amperage
CSA Certified	Top	Thermoset, Gray
Verified to Fed. Spec. W-S-896,	Toggle	Nylon
SP, DP, 3-way and 4-way	Terminals	Brass
	Terminal Screws	Brass
	Mounting Bridge	Nickel Plated Steel
	Contacts	Silver Alloy
	Moveable Contact Arm	Brass
	Rocker	Elastomer
	Ground Terminal	Nickel-Plated Steel
	Ground Screw	Brass
	Automatic Grounding Clip	Stainless Steel

Performance Data

Electrical	
Dielectric Voltage	Withstands 1500V AC minimum for 1 minute.
Max. Working Voltage	277V AC.
Overload	Minimum 4.8 times rated current for 100 cycles.
Temperature Rise	30°C maximum at rated current.
Max. Continuous Current	15A, 20A, 30A.
Endurance	50,000 cycles min., tungsten filament lamp load Fed. Spec. #WS896, SP, DP, 3-way and 4-way.
Mechanical	
Terminal Accommodations	#14 AWG min. - #10 AWG max. solid and stranded copper wire only.
Environmental	
Flammability	UL 94V-2.
Operating Temperature	Max. continuous: 75°C; Min. continuous: -40°C without impact.